

PCB TERMINAL BLOCKS

PCB TERMINAL BLOCKS

INTER-CONNECTION

FUSES & FUSE-HOLDERS

LEDs & INDICATORS

MINIATURE SWITCHES

LIMIT & SAFETY SWITCHES

CONTROL PRODUCTS

INTERFACE MODULES & SUPPORTS



RELAY BASES

ENCLOSURES

BATTERIES

TRANSFORMERS

7.5mm & 7.62mm Pitch Pluggable Rising Clamp Terminal

- 2-12 pole solid block
- Pluggable male-female connectors
- Open & closed headers
- Horizontal female plug style
- Polarised mouldings
- Moulded in green UL94-V0 flame retardant PA
- Professional rising clamp terminals
- 0.2-2.5mm² (30-12AWG) solid & stranded cable
- Anti solder wicking
- Captive screws
- Guided pin alignment
-    approved

SPECIFICATION

Rating	12A/500V UL=12A/300V, VDE&IMQ=20A/500V
Dielectric strength	≥3kV
Impulse withstand voltage	6kV
Working temperature	160°C
Moulding	UL94-V0 flame retardant PA
Pin/terminal	Tinned phosphor bronze
Rising clamp	Nickel copper flash brass
Screw/torque	M3 steel zinc plated, 0.5Nm
Recommended PCB hole size	ø1.4mm

7.5mm

TYPE NO.	POLES	LENGTH
CTB9400/2	2	13mm
CTB9400/3	3	20.5mm
CTB9400/4	4	28mm
CTB9400/5	5	35.5mm
CTB9400/6	6	43mm
CTB9400/7	7	50.5mm
CTB9400/8	8	58mm
CTB9400/9	9	65.5mm
CTB9400/10	10	73mm
CTB9400/11	11	80.5mm
CTB9400/12	12	88mm

7.62mm

TYPE NO.	POLES	LENGTH
CTB9408/2	2	13.2mm
CTB9408/3	3	20.9mm
CTB9408/4	4	28.5mm
CTB9408/5	5	36.1mm
CTB9408/6	6	43.7mm
CTB9408/7	7	51.3mm
CTB9408/8	8	59mm
CTB9408/9	9	66.6mm
CTB9408/10	10	74.2mm
CTB9408/11	11	81.8mm
CTB9408/12	12	89.4mm

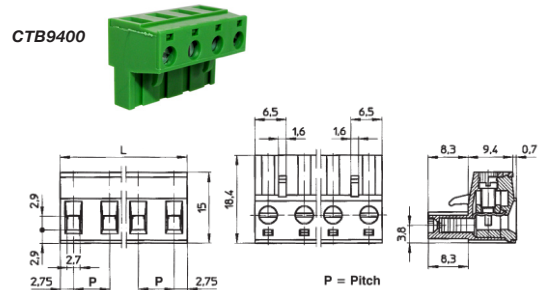

PCB mounting male vertical (closed ended)

7.5mm

TYPE NO.	POLES	LENGTH
CTB9500/2	2	15mm
CTB9500/3	3	22.5mm
CTB9500/4	4	30mm
CTB9500/5	5	37.5mm
CTB9500/6	6	45mm
CTB9500/7	7	52.5mm
CTB9500/8	8	60mm
CTB9500/9	9	67.5mm
CTB9500/10	10	75mm
CTB9500/11	11	82.5mm
CTB9500/12	12	90mm

7.62mm

TYPE NO.	POLES	LENGTH
CTB9508/2	2	13.2mm
CTB9508/3	3	20.9mm
CTB9508/4	4	28.5mm
CTB9508/5	5	36.1mm
CTB9508/6	6	43.7mm
CTB9508/7	7	51.3mm
CTB9508/8	8	59mm
CTB9508/9	9	66.6mm
CTB9508/10	10	74.2mm
CTB9508/11	11	81.8mm
CTB9508/12	12	89.4mm

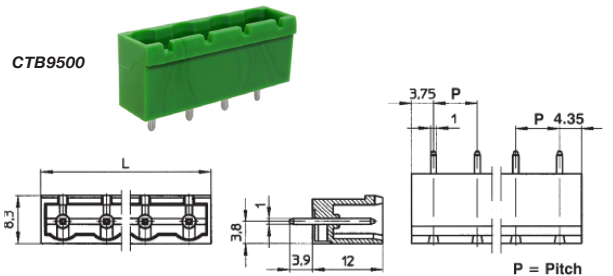

PCB mounting male horizontal (closed ended)

7.5mm

TYPE NO.	POLES	LENGTH
CTB9550/2	2	15mm
CTB9550/3	3	22.5mm
CTB9550/4	4	30mm
CTB9550/5	5	37.5mm
CTB9550/6	6	45mm
CTB9550/7	7	52.5mm
CTB9550/8	8	60mm
CTB9550/9	9	67.5mm
CTB9550/10	10	75mm
CTB9550/11	11	82.5mm
CTB9550/12	12	90mm

7.62mm

TYPE NO.	POLES	LENGTH
CTB9558/2	2	13.2mm
CTB9558/3	3	20.9mm
CTB9558/4	4	28.5mm
CTB9558/5	5	36.1mm
CTB9558/6	6	43.7mm
CTB9558/7	7	51.3mm
CTB9558/8	8	59mm
CTB9558/9	9	66.6mm
CTB9558/10	10	74.2mm
CTB9558/11	11	81.8mm
CTB9558/12	12	89.4mm

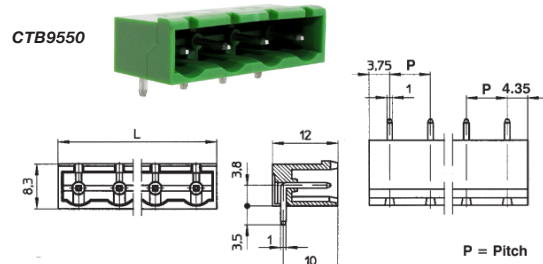

PCB TERMINAL BLOCKS

PCB mounting male vertical (open ended)

7.5mm

TYPE NO.	POLES	LENGTH
CTB9500/2AO	2	13mm
CTB9500/3AO	3	20.5mm
CTB9500/4AO	4	28mm
CTB9500/5AO	5	35.5mm
CTB9500/6AO	6	43mm
CTB9500/7AO	7	50.5mm
CTB9500/8AO	8	58mm
CTB9500/9AO	9	65.5mm
CTB9500/10AO	10	73mm
CTB9500/11AO	11	80.5mm
CTB9500/12AO	12	88mm

7.62mm

TYPE NO.	POLES	LENGTH
CTB9508/2AO	2	13.2mm
CTB9508/3AO	3	20.9mm
CTB9508/4AO	4	28.5mm
CTB9508/5AO	5	36.1mm
CTB9508/6AO	6	43.7mm
CTB9508/7AO	7	51.3mm
CTB9508/8AO	8	59mm
CTB9508/9AO	9	66.6mm
CTB9508/10AO	10	74.2mm
CTB9508/11AO	11	81.8mm
CTB9508/12AO	12	89.4mm

CTB9500/A0

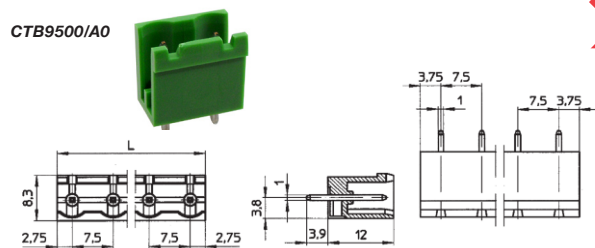

PCB mounting male horizontal (open ended)

7.5mm

TYPE NO.	POLES	LENGTH
CTB9550/2AO	2	13mm
CTB9550/3AO	3	20.5mm
CTB9550/4AO	4	28mm
CTB9550/5AO	5	35.5mm
CTB9550/6AO	6	43mm
CTB9550/7AO	7	50.5mm
CTB9550/8AO	8	58mm
CTB9550/9AO	9	65.5mm
CTB9550/10AO	10	73mm
CTB9550/11AO	11	80.5mm
CTB9550/12AO	12	88mm

7.62mm

TYPE NO.	POLES	LENGTH
CTB9558/2AO	2	13.2mm
CTB9558/3AO	3	20.9mm
CTB9558/4AO	4	28.5mm
CTB9558/5AO	5	36.1mm
CTB9558/6AO	6	43.7mm
CTB9558/7AO	7	51.3mm
CTB9558/8AO	8	59mm
CTB9558/9AO	9	66.6mm
CTB9558/10AO	10	74.2mm
CTB9558/11AO	11	81.8mm
CTB9558/12AO	12	89.4mm

CTB9550/A0

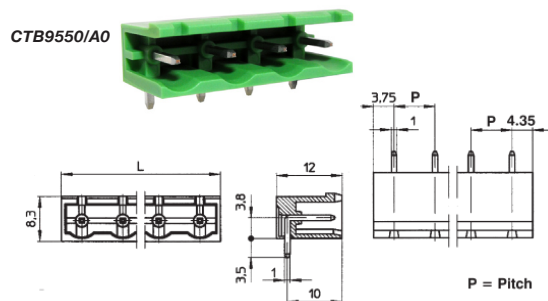

PCB
TERMINAL
BLOCKS

INTER-
CONNECTION

FUSES &
FUSE-
HOLDERS

LEDs &
INDICATORS

MINIATURE
SWITCHES

LIMIT &
SAFETY
SWITCHES

CONTROL
PRODUCTS

INTERFACE
MODULES &
SUPPORTS

RELAY
BASES

ENCLOSURES

BATTERIES

TRANS-
FORMERS



+44 (0)1638 716101
info@camdenboss.com
www.camdenboss.com

We operate a constant improvement policy,
our products are subject to change without notice.

Ver 1.0

CAMDENBOSS
ELECTRONICS & ENCLOSURES

X-ON Electronics

Largest Supplier of Electrical and Electronic Components

Click to view similar products for [camden manufacturer](#):

Other Similar products are found below :

[412689X](#) [CTBP92HE/10](#) [CTBP92VE/12R](#) [CTBP9350/12](#) [IND515205-240-T/GRN](#) [IND515205-240-T/RD](#) [IND5032405-240-T/GRN](#)
[CE10.00.EI](#) [C192SHAND](#) [RTM5006/16-PAT](#) [CNMB/6ST/2](#) [CNMB/4ST/2](#) [CSACST004](#) [CTBP9200/9](#) [CIME/M/BE2250SS](#) [CHH64E1BL](#)
[CIM/15W-DMFS](#) [CHHBAT2GY](#) [CFTBN/2](#) [CCB2S1/04](#) [CHDX6-222C](#) [CHDX8-224](#) [CHDASMP29](#) [CHDASMP34](#) [CHDX810DD](#)
[CHDX811DD](#) [CCTTM40LR](#) [CTBP92VJ/5S](#) [CTBP92VJ/8R](#) [CTSN431/12/M](#) [CTSN433/12/M](#) [CUABOX006](#) [IND513113-LED-RD](#)
[CE10.00.FM](#) [CBRPH-BLK](#) [RX2008/S-5-WH](#) [CBARD-CAR](#) [CRDCG0007](#) [CNMB/4/KIT](#) [CTB5050/5](#) [CTBP92HE/11](#) [CTBP9358/10AO](#)
[CHH66C2GY](#) [CHH456PBK](#) [CHH451ABK](#) [CIM/9W-DMFS](#) [CIM/25W-DMFS](#) [RTM5004/14-NC-BLK](#) [RTM5006/16-NC-BLK](#)
[IND5032405-125-T/AMB](#)