

# Plug-in Modules

3c1 + 760  
3c1 + 796

An 8 pin 'Octal' plug or an 11 pin 'Submagnal' plug with a clip-on black or transparent polycarbonate cover. Suitable for use with one to four 1/16" thick printed wiring boards (1.58" wide by 2.70" long max). For use with sockets X8 U, B8/UPM, XP11U, or B11/UPM.



Base 8 pin MP 4583  
Base 11 pin MP 4580  
Covers (8 or 11 pin)  
Black MP 4581  
Transparent MP 4595

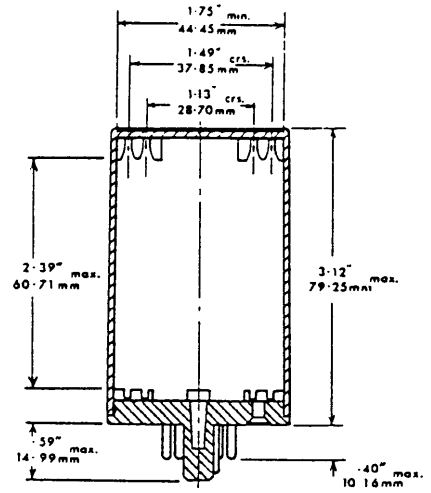
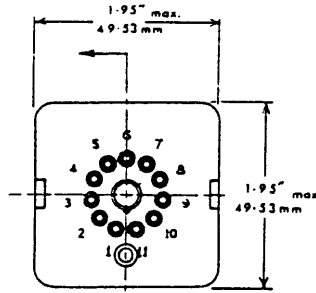

# Quartz Crystal Sockets

X2/UG-TN (tin)  
X2/UG-SPTDC (silver)  
Moulded in Nylon PF, for crystal style 'D'  
having pins .050" dia. spaced .486"  
1-27 12-34

N2/UE-TN (tin) or -SPTDC (silver). Solder tails.  
N2 UE P.C. - TN (tin). Printed wiring tails.  
Moulded in Nylon subminiature style for crystal 'K'  
having pins .040" dia. spaced .192"  
1-02 4-88

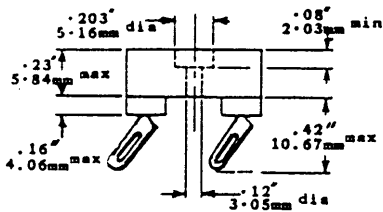
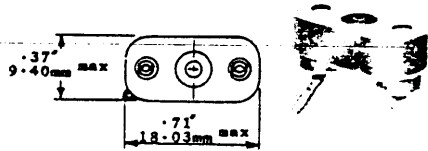

## MOUNTING DETAILS

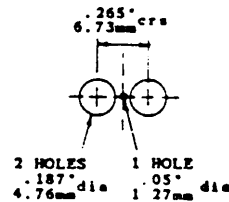
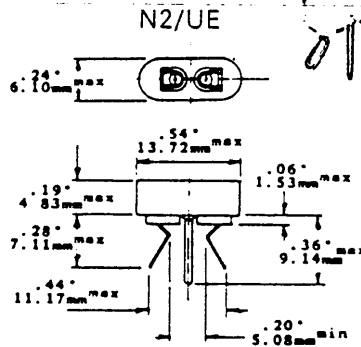
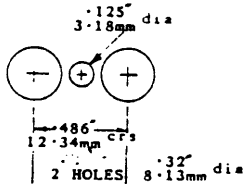

## N2 UE P.C.

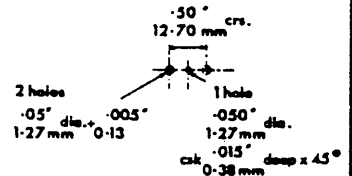
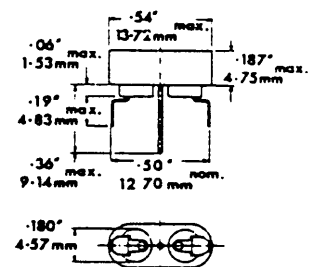

Details contained in this catalogue are correct at the time of going to press. McMurdo reserve the right to modify the connectors without prior notification.

March 1979

## The McMurdo Instrument Co Ltd

Rodney Road, Portsmouth, Hampshire PO4 8SG.  
Telephone: Portsmouth 735361 (STD Code 0705) Telex 86112

dules

301 + 760  
301 + 796

or an 11 pin 'Submagnal' plug with a clip-on black or transparent polycarbonate with one to four 1/16" thick printed wiring boards (1.58" wide by 2.70" long max). 3 U. B8/UPM, XP11U, or B11/UPM.

Base 8 pin MP 4583

Base 11 pin MP 4580

Covers (8 or 11 pin)

Black MP 4581

Transparent MP 4595

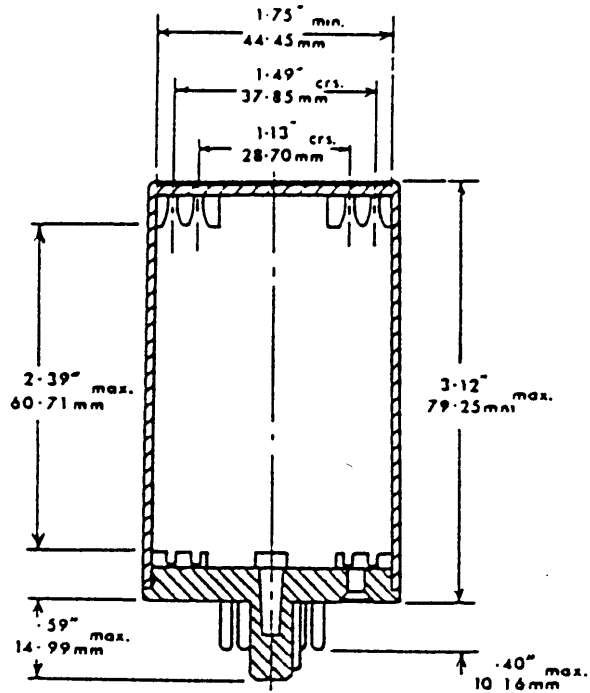
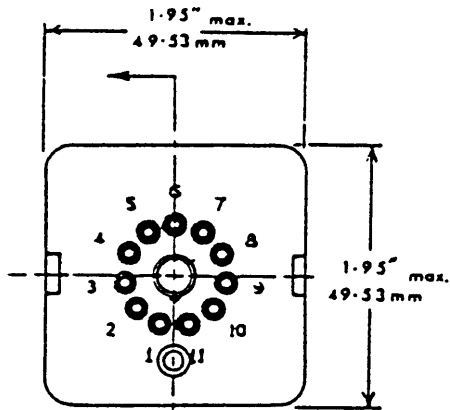

## Crystal Sockets

for crystal style 'D'  
pitch spaced .486"  
12-34

N2/UE-TN (tin) or -SPTDC (silver). Solder tails.  
N2 UE P.C. - TN (tin). Printed wiring tails.  
Moulded in Nylon subminiature style for crystal 'K'  
having pins .040" dia. spaced .192"  
1-02 4-88

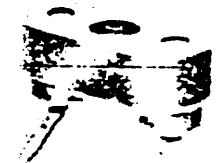

N2/UE

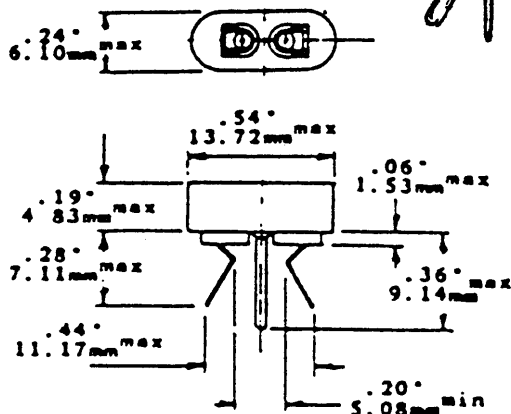

N2 UE P.C.

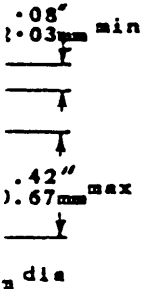
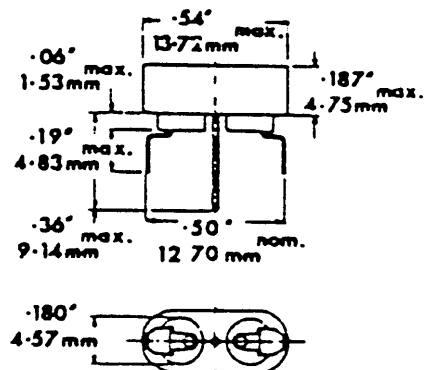

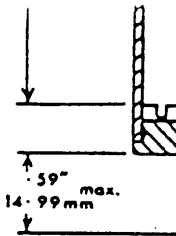
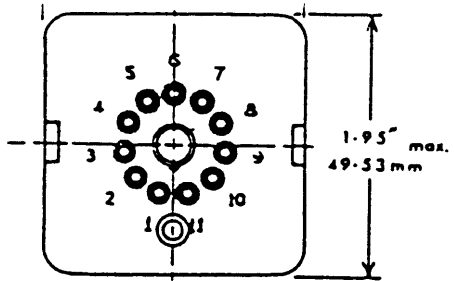
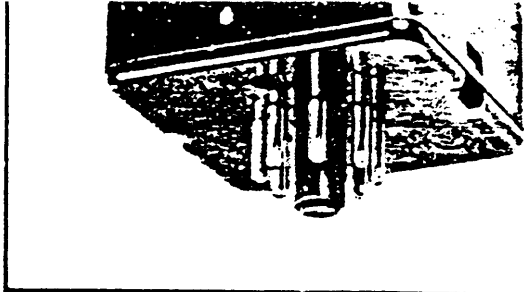

# Quartz Crystal Sockets

X2/UG-TN (tin)  
 X2/UG-SPTDC (silver)  
 Moulded in Nylon PF, for crystal style 'D'  
 having pins .050" dia. spaced .486"  
 1-27 12-34

N2/UE-TN (tin) or -SPTDC  
 N2 UE P.C. - TN (tin). Printed  
 Moulded in Nylon subminiature  
 having pins .040" dia. spaced  
 1-02

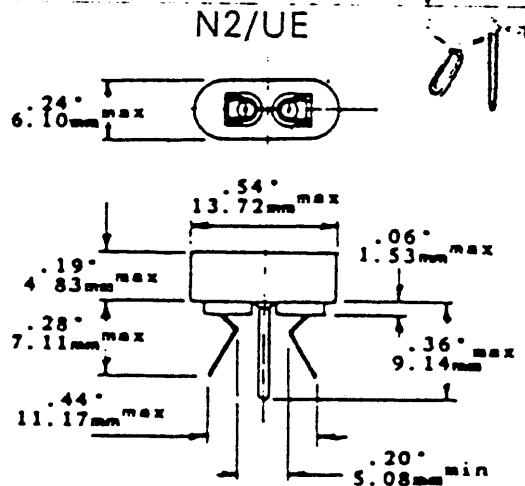
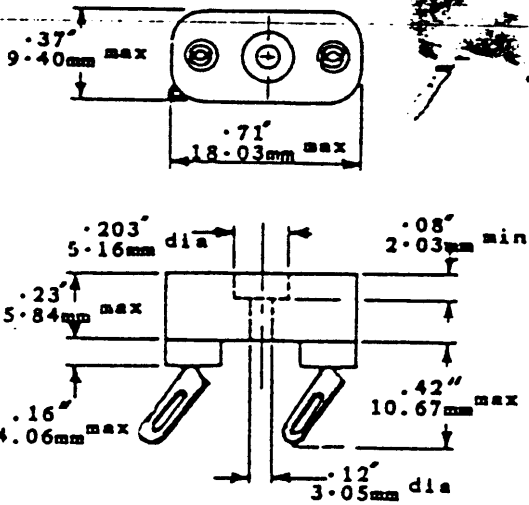

## MOUNTING DETAILS

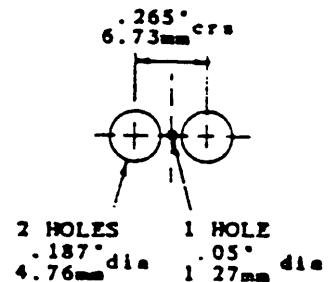
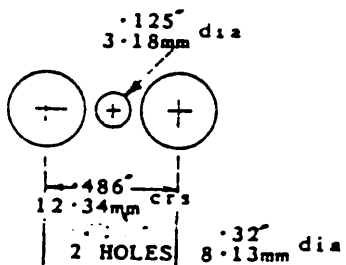

Details contained in this catalogue are correct at the time of going to press. McMurdo reserve the right to modify the connectors without prior notification.

## The McMurdo Instrument Co Ltd

Rodney Road, Portsmouth, Hampshire PO4 8SG.  
 Telephone: Portsmouth 735361 (STD Code 0705) Telex 86112

## **X-ON Electronics**

Largest Supplier of Electrical and Electronic Components

*Click to view similar products for [perancea](#) manufacturer:*

Other Similar products are found below :

[FFL4T](#) [FFL3T](#) [FFL2T](#) [SS232/20-5PK](#) [PCMC8](#) [CFL2T](#) [01BBN08](#) [PFL2T](#) [PCMC1](#) [01CBP76](#) [01CBP41](#) [01BBN11](#)