

REV	ECN	APP'D
-	3750	JEC 5/3/99
A	3893	JEC 1/6/00
B	3677	
C	6031	PJC 3-06-07
D	6138	PJC 10-22-07
E	6188	PJC 2-26-08

FXP SERIES PART NUMBERING SCHEME

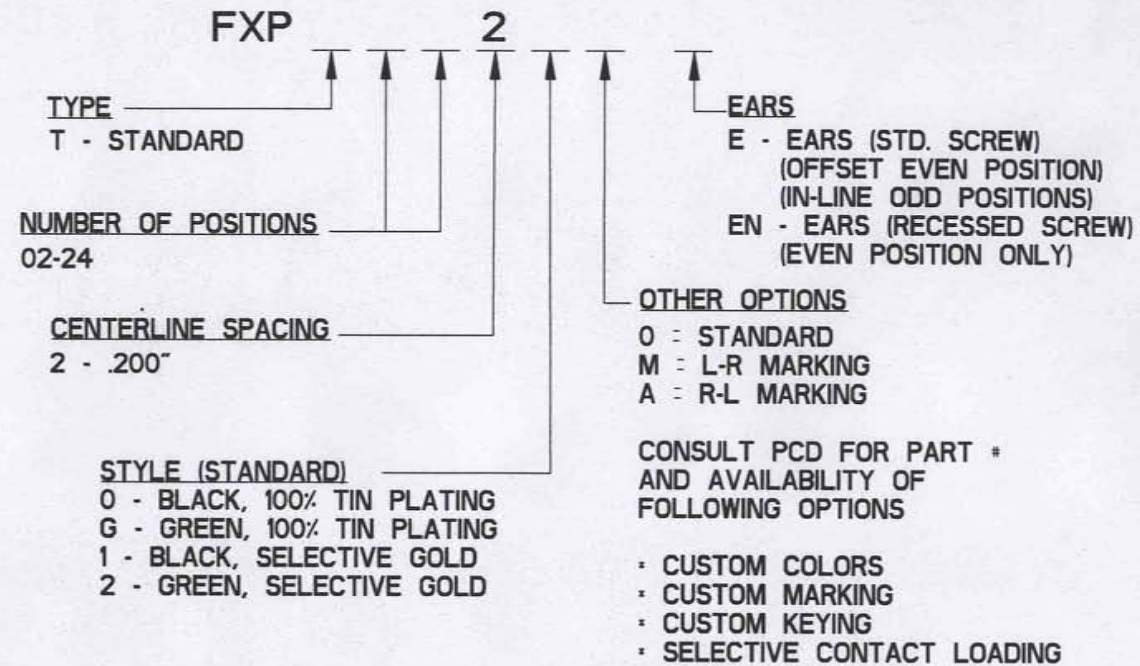

# POS	DIM "A"
2	.40
3	.60
4	.80
5	1.00
6	1.20
7	1.40
8	1.60
9	1.80
10	2.00
11	2.20
12	2.40
13	2.60
14	2.80
15	3.00
16	3.20
17	3.40
18	3.60
19	3.80
20	4.00
21	4.20
22	4.40
23	4.60
24	4.80

UL
RATINGS

CURRENT - 15A
VOLTAGE - 300V
U.L. FILE NO. E83421

SP
RATINGS

CURRENT - 15A
VOLTAGE - 300V
CSA FILE NO. LR69703

DIN VDE 0627:1986
DIN VDE 0110-1:1989
EN 60947-1:1991
EN 60947-7-1:1992

CURRENT - PENDING
VOLTAGE - PENDING
TUV FILE NO. PENDING

INSTALLATION RECOMMENDATIONS
WIRE RANGE: AWG #12-26, STRANDED
WIRE STRIP LENGTH: .310"
TIGHTENING TORQUE: 10 IN-LB

MATERIALS:
HOUSING: PPO, UL 94 V-0
CONTACT: COPPER ALLOY
SCREW: STEEL, NICKEL FINISH

MAX OPERATING TEMPERATURE:
105°C

DIMENSIONS ANSI Y14.5M UNITS: INCHES Pro/E FILE	TOLERANCES .XX ±0.02 .XXX ±0.010 ANGLES ±0.5°	PROJECTION 	AMPHENOL PCD SPECIFICATION DRAWING		FXP SERIES PLUG ASSEMBLY		
			<i>ENGR</i> D. MANTER 03-May-99				
ORIGINAL	<i>THIS DOCUMENT CONTAINS PROPRIETARY INFORMATION WHICH IS THE CONFIDENTIAL PROPERTY OF AMPHENOL PCD PEABODY, MA, USA</i>		<i>CHKD</i> A. PATRIE 03-May-99 <i>APPD</i> J. CAHALY 03-May-99		CODE: 58982	SCALE: NONE	SHEET 1 OF 3

**EVEN CONFIG
W/O EARS**

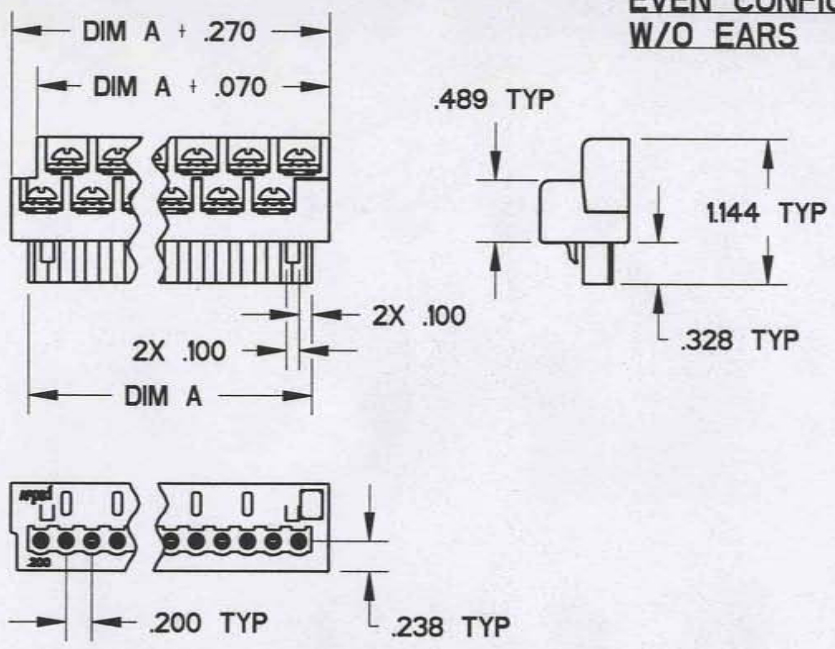

**EVEN CONFIG W/
OFFSET EARS**

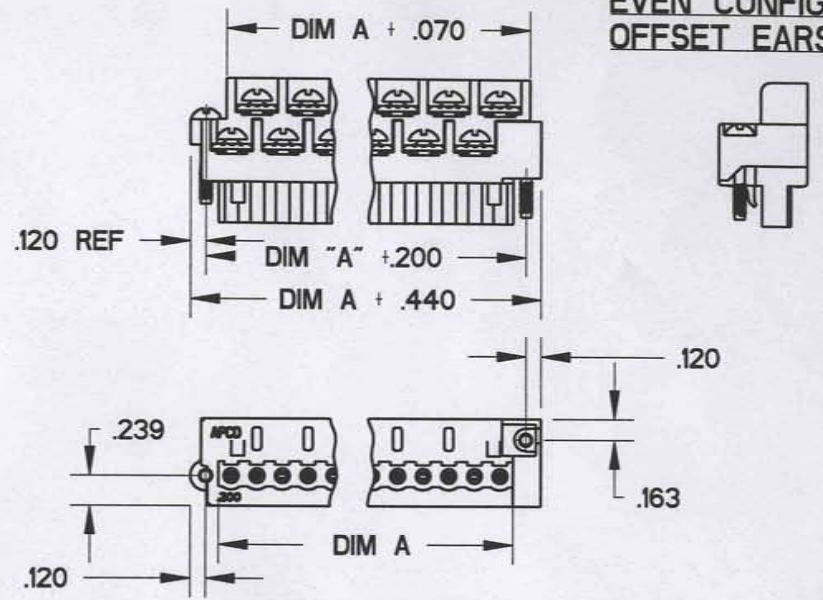

**ODD CONFIG
W/O EARS**

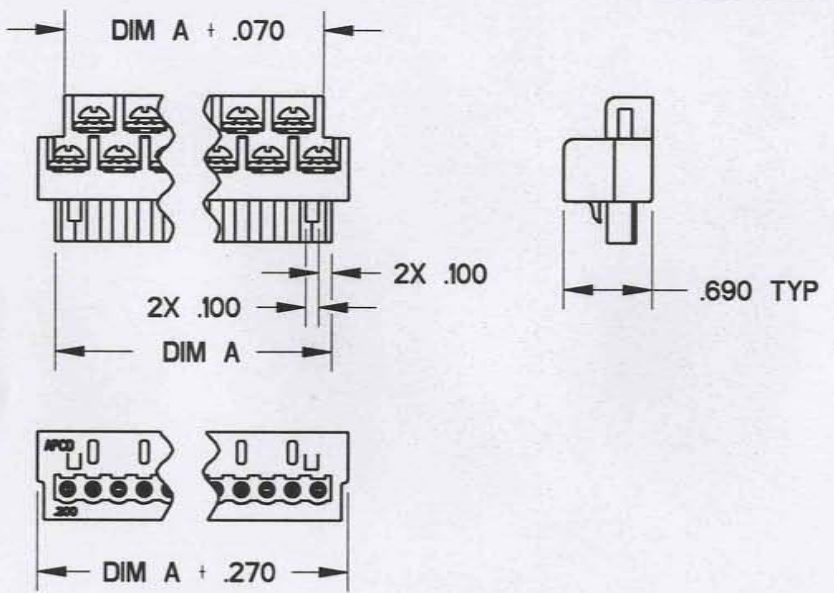

**ODD CONFIG W/
INLINE EARS**

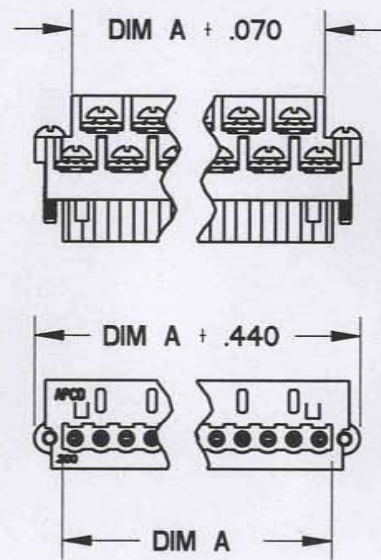

DIM A = NUM OF POS X CL SPACING

SIZE	DWG NO.	REV
A	FXPTXX200	E
CODE: 58982	SCALE: NONE	SHEET 2 OF 3

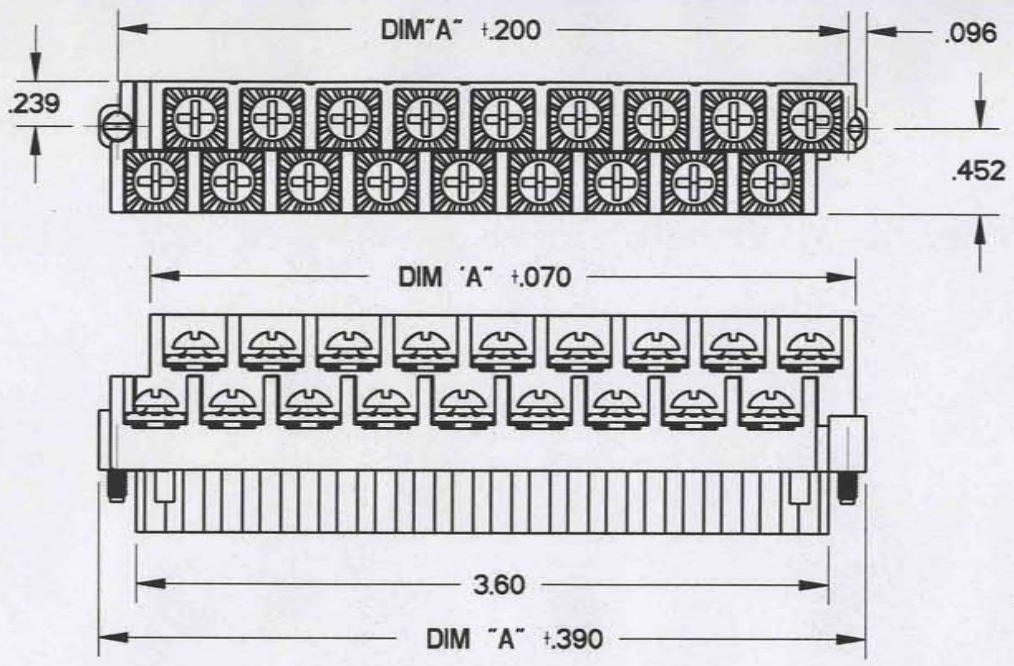

EVEN CONFIG W/ IN-LINE EARS & RECESSED MOUNTING SCREW

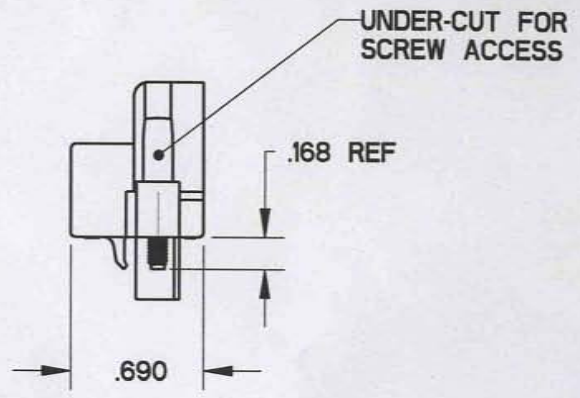

SIZE	DWG NO.	REV
A	FXPTXX200	E
CODE: 58982	SCALE: NONE	SHEET 3 OF 3

X-ON Electronics

Largest Supplier of Electrical and Electronic Components

Click to view similar products for [Barrier Terminal Blocks](#) category:

Click to view products by [Amphenol](#) manufacturer:

Other Similar products are found below :

[CTA-0103](#) [6PCR-02-008](#) [6PCR-05-008](#) [6PCR-08-008](#) [6PCR-21-006](#) [6PCV-06-008](#) [6PCV-10-009](#) [6PCV-15-008](#) [6STR-06-006](#) [6STR-08-006](#) [6STR-12-008](#) [6STR-14-008](#) [6STR-16-008](#) [6STR-17-008](#) [6STR-21-008](#) [6STR-25-008](#) [6STR-27-008](#) [6STV-03-006](#) [6STV-03-008](#) [6STV-04-006](#) [6STV-10-006](#) [6WWR-03](#) [6WWV-11-008](#) [6WWV-12-008](#) [6WWV-16-008](#) [7-1546701-0](#) [72212603](#) [72503-C](#) [73203](#) [76007](#) [7606-602LF](#) [77010-50](#) [796985-3](#) [796988-4](#) [7C1N08](#) [8-1437402-5](#) [8-1437402-7](#) [8-1546158-0](#) [870505](#) [870903](#) [8PCR-06-006](#) [8PCV-02-008](#) [8PCV-04-008](#) [8PCV-05-008](#) [8PCV-09-006](#) [8PCV-15-006](#) [8PCV-16-006](#) [8PCV-17-006](#) [8QCR-03-008](#) [8STV-04-006](#)