

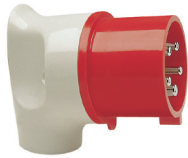

Ampère	Poles	110 V 50 a. 60 Hz			230 V 50 a. 60 Hz			400 V 50 a. 60 Hz			500 V 50 a. 60 Hz			> 50 - 500 V 100 - 300 Hz			> 50 - 500 V over 300 - 500 Hz				
		3pole 4h	4pole 4h	5pole 4h	3pole 6h	4pole 9h	5pole 9h	3pole 9h	4pole 6h	5pole 6h	3pole 7h	4pole 7h	5pole 7h	3pole 10h	4pole 10h	5pole 10h	3pole 2h	4pole 2h	5pole 2h		

Part numbers



16	3	216 304	216 306	216 309															10	106
16	4	216 404	216 409	216 406		216 407		216 410		216 402									10	150
16	5	216 504	216 509	216															10/60	163
32	3	236 304	236 306	236 309															10	214
32	4	236 404	236 409	236 406		236 407		236 410		236 402									10	230
32	5	236 504	236 509	236															10	251

236 **mondo plugs** Δ IP 44, angled, back part RAL 7035 light grey



16	5			210 PH															10	180
16	5			210 PHNI	(with nickel plated contacts + glass-fibre reinforced enclosure)													10	183	
32	5			230 PH															10	257
32	5			230 PHNI	(with nickel plated contacts + glass-fibre reinforced enclosure)													10	264	

230 PH **Phase inverters** Δ IP 44, with flexible cable entry



16	5			211 PH															10	174
16	5			211 PHNI	(with nickel plated contacts + glass-fibre reinforced enclosure)													10	180	
32	5			231 PH															10	245
32	5			231 PHNI	(with nickel plated contacts + glass-fibre reinforced enclosure)													10	257	

231 PH **Phase inverters** Δ IP 44, with gland entry



16	4			210 406 DF															10	144
16	5			210 DF															10	173
32	4			230 406 DF															10	198
32	5			230 DF															10	241
63	4			260 406 DF															10	603
63	5			260 DF															5	685

for voltage ranges
of 110 V - 690 V

230DF **Phase sequence control plugs** Δ IP 44



16	3	219 304	219 306	219 309	(with gland entry and screw terminals)										10	133
----	---	---------	----------------	---------	--	--	--	--	--	--	--	--	--	--	----	-----

All red marked plugs come with new design and cable gland. Additionally these are also available as **screwless version** with IDC insulation displacement connection. To order a plug as screwless version, just add „SL“ to the part number, e.g. 219SL.

16	4	219 404	219 409	219 406	219 407	219 410	219 402	10	212
16	5	219 504	219 509	219				10	236
32	3	239 304	239 306	239 309				10	290
32	4	239 404	239 409	239 406	239 407	239 410	239 402	10	300
32	5	239 504	239 509	239				10	340

Plugs \blacklozenge IP 67, with screw terminals or as screwless SL version with insulation displacement technique



16	5			219 NI															10	199
32	5			239 NI	(with nickel plated contacts and glass-fibre reinforced enclosure)													10	286	
63	5			269 NI															5	771
125	5			279 NI															2	1473
63	3	269 304	269 306	269 309															5	501
63	4	269 404	269 409	269 406	269 407	269 410	269 402	5	623											
63	5	269 504	269 509	269				5	668											
125	3	279 304	279 306	279 309															2	1185
125	4	279 404	279 409	279 406	279 407	279 410	279 402	2	1329											
125	5	279 504	279 509	279				2	1473											

269 **Plugs** \blacklozenge IP 67, with gland entry

Availability of blue printed (or not listed) frequencies and voltages up to 690 V on request!

Other voltages and frequencies on request. Part numbers in bold letters are standard versions.

Amp.	16			32			63		
Poles	3	5	5	3	4	5	3	4	5
d	143	153	181	252	252	252	252	252	252
Øe	51	65	72	81	81	81	81	81	81
f	60	75	88	97	97	97	97	97	97
m	108	117	138	192	192	192	192	192	192
n	37	37	46	67	67	67	67	67	67
Øp	7/13	8/21	11/24	15/33	15/33	15/33	15/33	15/33	15/33

210 306, 260 etc. and NI versions

Amp.	16			32		
Poles	3	4	5	3	4	5
d	85	98	98	115	115	115
e	50.3	64.3	64.3	72	72	72
f	70	86	86	96	96	100
n	37	37	37	45.8	45.8	45.8
p	8/15	10/16.5	10/16.5	11/22	11/22	11/22

216, 236 etc.

Amp.	16	32
Poles	5	5
d	153	181
Øe	65	72
f	75	88
m	117	138
n	37	46
Øp	8/21	11/24

210PH, 230PH & NI versions

Amp.	16	32
Poles	5	5
d	131	155
Øe	65	73
f	75	88
m	112	133
n	37	46
Øp	7.5-14.5	10-19.5

211PH, 231PH & NI versions

Amp.	16		32		63	
Poles	4	5	4	5	4	5
d	65	65	155	72	240	81
Øe	58	65	72	72	81	81
f	68	75	79	88	97	97
n	37	37	46	46	67	67

230DF etc.

Amp.	16
Poles	3
d	126
m	110
n	37
u	72
Øp	7.5-14.5

219 306 etc. (black part nos.)

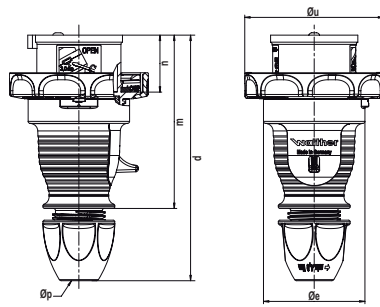

Page 14, item 5b

Amp.	16	16	32	32
Poles	4	5	3 / 4	5
d	150-161	150-161	174-183	174-183
Øe	Ø 65	Ø 65	Ø 72	Ø 72
m	111	111	127	127
n	36.5	36.5	45.5	45.5
Øu	Ø 81	Ø 89	Ø 95	Ø 100
Øp	7.5 / 19.5	7.5 / 19.5	9.6 / 24.5	9.6 / 24.5

219, 239 etc. (red part nos.)

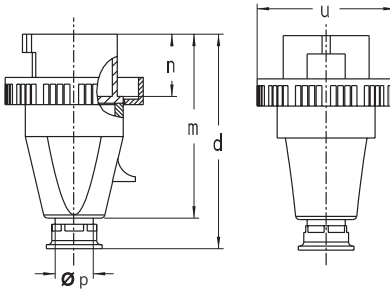

Page 14, item 6

Amp.	16		32			63			125		
Poles	5	5	3	4	5	3	4	5	3	4	5
d	139	166	243	243	243	315	315	315	315	315	315
m	114	135	195	195	195	258	258	258	258	258	258
n	37	46	67	67	67	75.5	75.5	75.5	75.5	75.5	75.5
u	88	103	110	110	110	130	130	130	130	130	130
Øp	10-19.5	18-24.5	18-35	18-35	18-35	24-45	24-45	24-45	24-45	24-45	24-45

219 NI, 239 NI, 269, 279 etc.

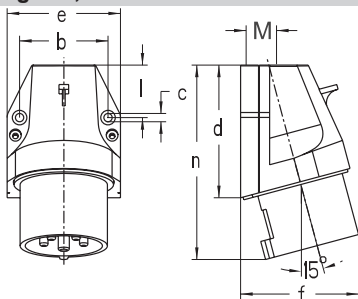

Page 15, item 1

Amp.	16			32		
Poles	3	4	5	3	4	5
b	45.5	60	60	60	60	60
c	5.3	5.3	5.3	5.3	5.3	5.3
d	74	80	80	97	97	97
e	60	74	74	82	82	82
f	60	73	73	80	80	86
l	28	31	31	45	45	45
n	110	117	117	141	141	141
M	20	20	20	25	25	25

610, 630 etc.

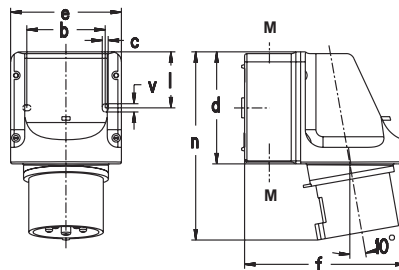

Page 15, item 2

Amp.	16		32		
Poles	4	5	3	4	5
b	66.5	66.5	66.5	66.5	66.5
c	5	5	5	5	5
d	96	96	96	96	96
e	95	95	95	95	95
f	140	140	140	140	140
l	47.5	47.5	47.5	47.5	47.5
n	151	151	160	160	160
v	7	7	7	7	7
M	20/25	20/25	20/25	20/25	20/25

616, 636 etc.

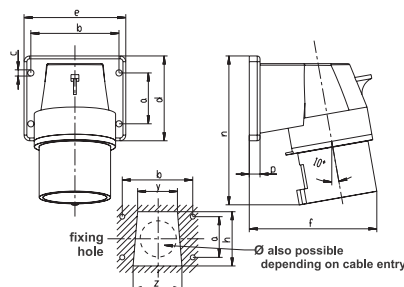

Page 15, item 3

Amp.	16			32			63		
Poles	3	4	5	3	4	5	3	4	5
a	30	40	40	45	45	45	90	90	90
b	55	68	68	78	78	78	90	90	90
c	5.5	5.5	5.5	5.5	5.5	5.5	6.2	6.2	6.2
d	52	66	66	75	75	75	114	114	114
e	65	80	80	90	90	90	114	114	114
f	72	90	92	103	103	103	116	116	116
h	38	52	52	60	60	60	70	70	70
n	97	110	110	129	129	129	185	185	185
p	9.5	9.5	9.5	9.5	9.5	9.5	6	6	6
y	30	38	38	44	44	44	56	56	56
z	36	46	46	54	54	54	65	65	65

611, 631, 661 etc.

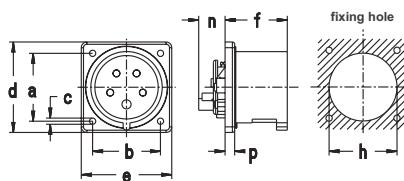

Page 15, item 4

Amp.	16			32		
Poles	3	4	5	3	4	5
a	47	60	60	60	60	60
b	47	60	60	60	60	60
c	5.5	5.5	5.5	5.5	5.5	5.5
d	62	80	80	80	80	80
e	62	80	80	80	80	80
f	47	47	47	56	56	56
h	50	67	67	71	71	71
n	22	22	22	22	22	22
p	8.5	8.5	8.5	8.5	8.5	8.5

615, 635 etc.

X-ON Electronics

Largest Supplier of Electrical and Electronic Components

Click to view similar products for [walther](#) manufacturer:

Other Similar products are found below :

[339306](#) [269306](#) [239](#) [630406](#) [330](#) [10110](#) [269](#) [430304](#) [130406](#) [630306](#) [410](#) [319306](#) [10280](#) [630](#) [10380](#) [410306](#) [610304](#) [10400](#) [210304](#)
[310306](#) [410304](#) [330304](#) [230304](#) [230306](#)