



Pass & Seymour

Wall Plates Dustproof Stainless Steel Covers One & Two Gang

WP1, WP2, WP7, WP8, WPH8, WP26, WPH26, WP13, WP23, WPH1-L, WPH7-L, WPH8-L, WP26-L

Exceptional durability plus dust protection.

These brushed stainless steel dust covers are designed to handle challenging conditions including dusty, corrosive environments, or hard-use areas. Yet they provide a smooth, handsome style that fits in anywhere. Note: these covers are not suitable for wet locations — see our Weatherproof Covers if water resistance is required.



Features & Benefits

Aesthetically pleasing design.

These stainless steel covers are dustproof only and do not meet NEC 406.8(A) or (B).



Stainless steel springs.

Made of .030 inch thick 302 brushed stainless steel to help protect against corrosion.











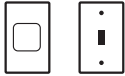

WP26-L

Field Uses/Vertical Markets

- Industrial
- Health Care
- Education
- Institutional
- Retail
- Office
- Hospitality/Lodging
- Multiple Dwelling

Wall Plates Dustproof Stainless Steel Covers One & Two Gang

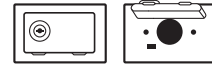
Ordering Information

Catalog Number	Description
One & Two Gang Dust Covers	
 WP1	1 Toggle Switch 1 Small Cover, Vertical 1 Gang Plate Available for Box Mount – add suffix -FS.
 WP2	2 Toggle Switches 2 Small Covers, Vertical 2 Gang Plate
 WP7	1 Single Receptacle 1 Small Cover, Vertical 1 Gang Plate Available for Box Mount – add suffix -FS.
 WP8	1 Duplex Receptacle 1 Long Cover, Vertical 1 Gang Plate
 WPH8	1 Duplex Receptacle 1 Long Cover, Horizontal 1 Gang Plate
 WP26	1 Decorator/GFCI 1 Long Cover, Vertical 1 Gang Plate
 WPH26	1 Decorator/GFCI 1 Long Cover, Horizontal 1 Gang Plate
 WP13	1 Gang Blank (Box Mounted) Gasketed
 WP23	2 Gang Blank (Box Mounted) Gasketed
Locking Dust Covers	
 WPH1-L	Toggle Opening Horizontal
 WPH7-L	Single Receptacle Opening Horizontal
 WPH8-L	Duplex Receptacle Opening Horizontal
 WP26-L	Decorator/GFCI Vertical
WP255-K	Key for all Dustproof Locking Covers. (Two keys furnished with each unit.)

For more information on these and other P&S products refer to our Product Guide or visit our web site.

Wall Plates Dustproof Stainless Steel Covers One & Two Gang



Pass & Seymour

Technical Specifications

3rd Party Compliance	
UL Listed. CSA Certified.	

Performance	
Environmental	Dustproof Only

Materials	
Body	.030" 302 Stainless Steel
Finish	Brushed
Springs	Stainless Steel 17-7
Screws	302 Stainless Steel
Gasket	Vinyl
Lock	Stainless Steel

Warranty

1 Year

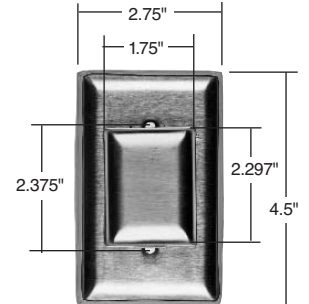

Dimensions for
WP1 & WP7

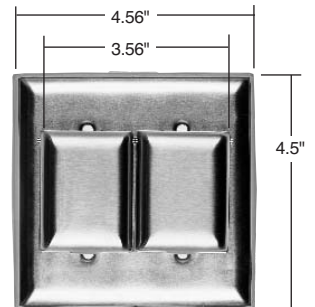

Dimensions for
WP2

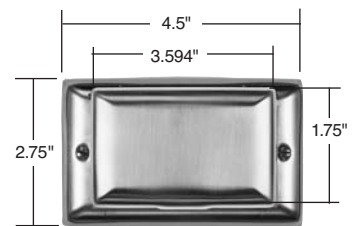

Dimensions for
WPH8 & WPH26

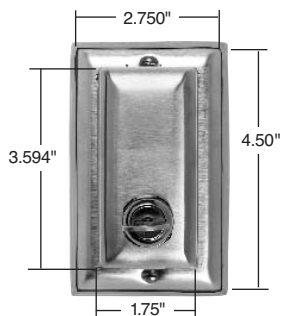

Dimensions for
Vertical Locking

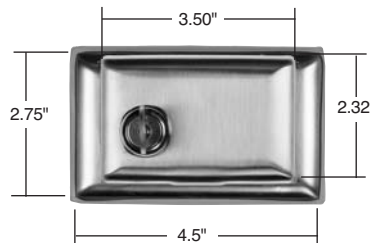

Dimensions for
Horizontal Locking

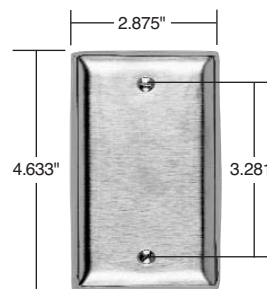

Dimensions for
WP13

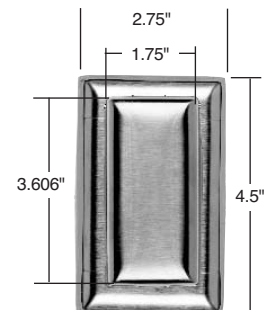

Dimensions for
WP8 & WP26

Complementary Devices & Accessories



WALL PLATES

- TradeMaster® Thermoplastic Nylon
- Stainless Steel
- Brass
- Aluminum

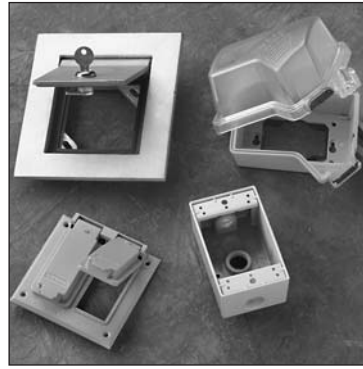

WEATHERPROOF BOXES & COVERS

- While-In-Use Covers
- Heavy Cast Aluminum Covers
- Cast Covers
- Boxes

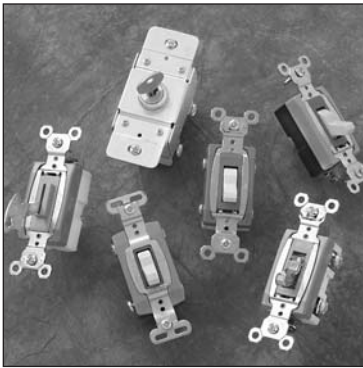

SWITCHES

- Heavy-Duty Toggle
- Heavy-Duty Lighted Toggle
- Heavy-Duty Security
- Heavy-Duty Locking
- Construction Grade Toggle
- Commercial Grade Toggle

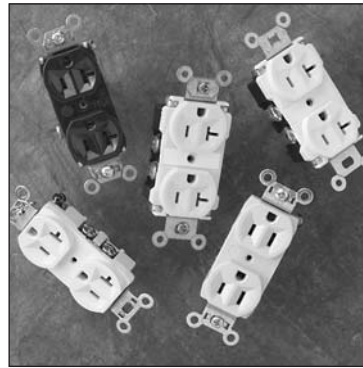

STRAIGHT BLADE RECEPTACLES

- Extra Heavy-Duty
- Heavy-Duty
- Construction Grade
- Commercial Grade

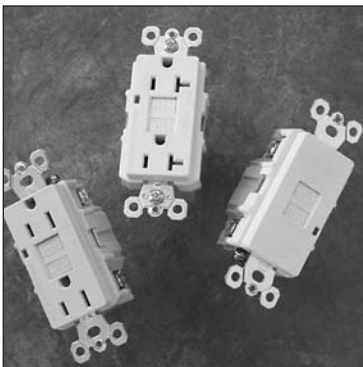

GFCIs

- Construction Grade with Auto-Ground
- Construction Grade
- Construction Grade Dead Front

Also available...

- Light Almond Devices
- Decorator Devices
- Hospital Grade Devices
- PlugTail™ Devices
- TVSS & Isolated Ground Devices
- Ground Continuity Monitoring (GCM)
- Straight Blade Plugs & Connectors
- Turnlok® Locking Devices
- IEC 309 Industrial Products
- Flexcor® Wire Mesh Grips
- Configurable Solutions



Legrand/Pass & Seymour
 P.O. Box 4822
 Syracuse, NY 13221-4822
 800-223-4185

North America Headquarters
 60 Woodlawn Street
 West Hartford, CT 06110
 Phone: 1.877.BY.LEGRAND (295.3472)
 Fax: 1.860.232.2062
 www.legrand.us

Legrand Canada
 570 Applewood Crescent
 Vaughan, ON, L4K 4B4
 Phone: 905.738.9195
 Fax: 905.738.9721
 www.legrand.ca

X-ON Electronics

Largest Supplier of Electrical and Electronic Components

Click to view similar products for [pass & seymour](#) manufacturer:

Other Similar products are found below :

[5278-SS](#) [L1530-P](#) [PSL515C](#) [L1430P](#) [L1420P](#) [L16-30C](#) [PS5965-Y](#) [PS5366X](#) [PS5969-Y](#) [S-2348-DF](#) [WPH26](#) [L16-30P](#) [L530C](#) [PS5269X](#)
[PS5266X](#) [PS5266XHG](#)