

LXW8-PW50 Luxeon Rebel Starboard LED



Opulent Part Number: REBEL-STAR-ES-8PW50

Opulent Starboard: MCPCB

Luxeon Rebel LED: LXW8-PW50

Features

- Excellent thermal conductivity
- Excellent insulating ability
- Excellent Dimensional Stability
- Excellent Mechanical Strength
- Lower heat expansibility
- Lower operating temperature
- Increase power density
- Reduce the number of interconnects
- Extend the life of dies

OP REBEL STAR



OP REBEL STAR
ALUMINUM CLAD PRINTED
CIRCUIT BOARD FOR
LUXEON REBEL ALLOWS
OPTIMUM HEAT
DISSIPATION.



This is a custom MCPCB structure that further enhances heat dissipation and thus enabling the LED to last according to its life time.

Higher thermal conductive MCPCB is also available with our special enhanced capabilities.

CONSTRUCTION OF MCPCB

The structure of the aluminum material includes copper layer, dielectric layer laminated together with aluminum base layer. Below appends summary of available range of material:

Aluminum Type	Aluminum Thickness	Copper Thickness	Dielectric Thickness
AL 5052	1.5 mm	1 oz	0.100mm

PANEL DRAWING

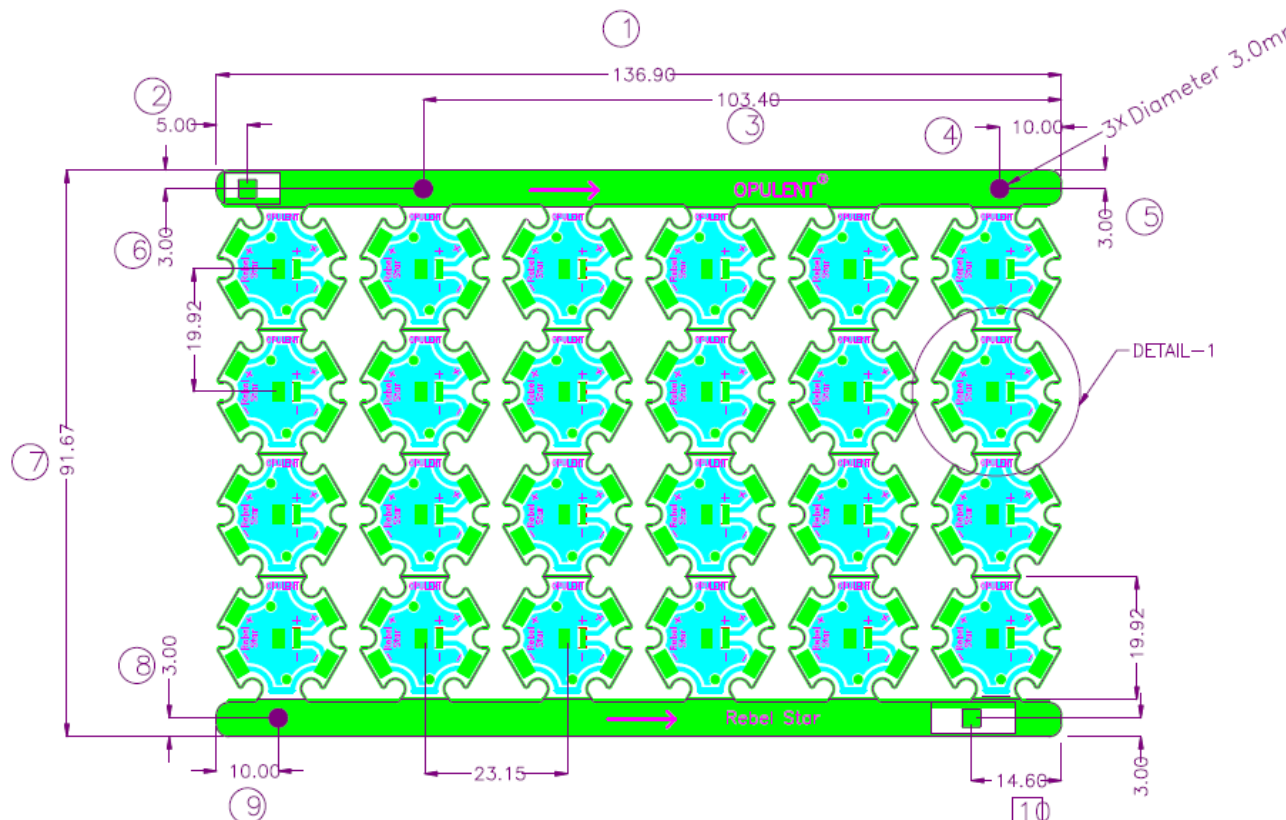

MATERIAL DATASHEET

Material Datasheet - OPT111.01.AI5215.4.0018			
	Treatment Condition	Value	Unit
Thermal Properties			
Thermal Conductivity (Dielectric layer)		1.8	W/m-k
Thermal Resistance (Dielectric layer)		0.086	°C-in ² /W
Maximum Operating Temperature	UL 746	125	°C
Glass Transition Temp (Tg)	DSC	130	°C
Coefficient of Thermal Expansion (CTE)	< Tg	21.5	x10 ⁻⁶ /°C
	> Tg	22.0	
Electrical Properties			
Dielectric constant	1kHz/1MHz	4.2	—
Dissipation Factor	1kHz/1MHz	0.02	—
Volume Resistivity	C-96/40/90	1×10 ⁸	MΩ·cm
Surface Resistivity	C-96/40/90	1×10 ⁷	MΩ
Dielectric Breakdown Voltage	A	30	KV/mm
Mechanical Properties			
Dielectric Thickness	A	100	μm
Peel Strength	A	1.05	N/mm
Chemical Properties			
Water absorption	D-24/23	0.09	%
Ratings and Durability			
UL Flammability		94 V-0	—
Comparative Tracking Index	IEC60112	600	V
Thermal stress	10 sec @ 288 °C, 3 cycles	Pass	—
Time to delamination	5min @ 260 °C	Pass	—

* The data is based on typical values of standard production and should be considered as general information. Our company reserves the right for future changes. It is the responsibility of the user to ensure that the product complies with his requirements.

PRODUCT SPECIFICATIONS

OP REBEL STAR MCPCB

Aluminum Type:	AL5052
Aluminum Thickness:	1.5mm
Copper Thickness:	1oz
Dielectric Thickness:	0.1mm
Unit Size:	21.38 x 19.92mm (±0.1mm)
Panel Size:	136.9 x 91.67mm (24pcs/pnl)
Finishing:	OSP
Solder Mask:	Glossy Black

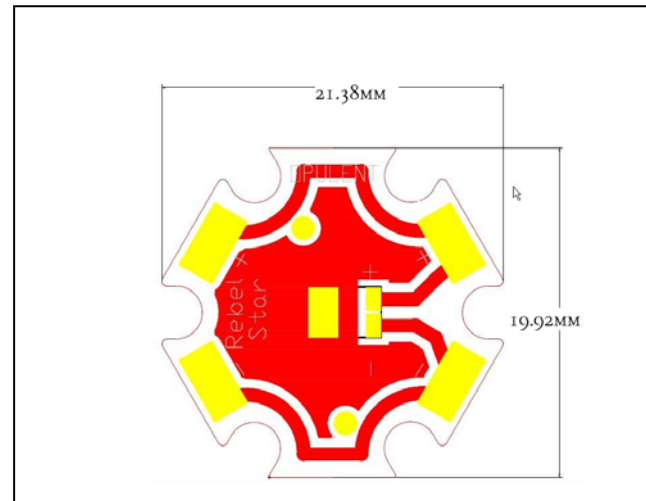

SOLDER PASTE

Type:	Leadfree SAC 305 paste, grade 3 or above
Lumileds Internal:	Alpha Metal OM325 grade 4
Alternative:	Alpha Metal OM338 grade 3

PACKAGING

One carton consists of 10 internal white boxes. Each white box consists of 3 trays. Each tray consists of 48 pieces.

Type of tray:	Individual slot for each OP Rebel Star
Cavity per tray:	48 pcs
Dimension of tray:	44.3cm x 17.25cm x 2.3cm
Internal White Box:	contains 3 trays with 1 cover tray (equivalent to 144pcs of OP Rebel)
Dimension of I.W.B:	44.8cm x 17.7cm x 5.5cm
Carton box:	contains 10 white boxes (equivalent to 1440pcs of OP Rebel Star)
Dimension of carton:	45.5cm x 36.4cm x 28.5cm

ABOUT OPULENT

Opulent (Asia)

Email: sales@opulent-group.com

Singapore ☎: +65 67498188 (Head Office)

Headquartered in Singapore, Opulent has more than 20 years experience in the manufacturing of conventional printed circuit boards (PCBs). Embarking for an international presence, Opulent has set up sales and marketing support in China, Hong Kong, Germany, Italy, United Kingdom and Malaysia.

Through innovation and R&D, Opulent created metal-clad PCBs (MCPCB) and is currently a leading designer and manufacturer of thermal solutions. Our products and works are guided by a customer centric approach that empowers us to provide value added solutions from design to assembly.

Our customers are well-known international brands whom have come to trust Opulent for our innovation, our knowledge and our commitment to attain customer satisfaction.



LUXEON Rebel ES

*Leading efficacy and light output,
maximum design flexibility*

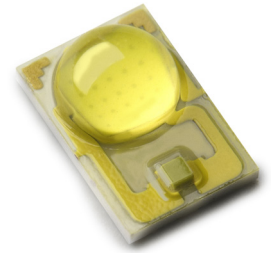

Introduction

LUXEON Rebel ES gives you the flexibility you need for designing luminaires and lamps. Tested and binned at 700 mA, confidently design LUXEON Rebel ES into high lumen applications or create more energy efficient devices using the same emitter. Luminaire manufacturers and designers count on LUXEON Rebel ES for quality, reliability and in-device performance.

Features and Benefits

- Broad portfolio of emitters for indoor and outdoor applications
- CCT and CRI combinations to support a wide range of applications
- Highest lumens per watt and lumens per dollar
- Lowest forward voltage
- Industry Standard ANSI color binning
- Superior >125 lm/W efficacy enables efficient and sustainable applications
- Industry leading lumen maintenance
- Complete design resources available to support your application development

Key Applications

- Outdoor
- Portable

Table of Contents

Introduction	1
General Information	2
Product Nomenclature	2
Average Lumen Maintenance Characteristics	3
Environmental Compliance	3
Product Selection Guide	4
Optical Characteristics	5
Electrical Characteristics	6
Absolute Maximum Ratings	7
JEDEC Moisture Sensitivity	7
Reflow Soldering Characteristics	8
Mechanical Dimensions	9
Pad Configuration	10
Solder Pad Design	10
Relative Spectral Distribution vs. Wavelength Characteristics	11
Typical Light Output Characteristics	15
Typical Forward Current Characteristics	15
Typical Luminous Efficacy	16
Current Derating Curves	18
Typical Radiation Pattern	20
Emitter Pocket Tape Packaging	21
Emitter Reel Packaging	22
Product Binning and Labeling	23
Luminous Flux Bins	24
LUXEON Rebel ES ANSI 1/4th Quadrant Color Bin Structure	28
LUXEON Rebel ES ANSI 1/4th Quadrant Bin Structure	30
Forward Voltage Bins	31

General Information

Product Nomenclature

LUXEON Rebel ES is tested and binned at 700mA, with current pulse duration of 20 ms. All characteristic charts where the thermal pad is kept at constant temperature (25°C typically) are measured with current pulse duration of 20 ms. Under these conditions, junction temperature and thermal pad temperature are the same.

The LUXEON Rebel ES family of emitters contain a series of LEDs designed for Illumination applications.

The part number designation for the LXML series is explained as follows:

L X M L - A B C D

Where:

- A — designates radiation pattern (value P for Lambertian)
- B — designates color (W for White)
- C — designates color variant (C for Cool-White, N for Neutral-White)
- D — designates test current (value 2 for 700mA)

The part number designation for the LXW8 series is explained as follows:

L X W A - B C D E

Where:

- A — designates minimum CRI performance (value 8 = 80 minimum and 9 = 90 minimum)
- B — designates radiation pattern (value P for Lambertian)
- C — designates color (value W = White)
- D & E — designates nominal ANSI CCT (value 27 = 2700K, 30 = 3000K, 35 = 3500K, 40 = 4000K and 50 = 5000K)

The part number designation for the LXH7 series is explained as follows:

L X H A - B C D E

Where:

- A — designates minimum CRI performance (value 7 = 70 minimum)
- B — designates radiation pattern (value P for Lambertian)
- C — designates color (value W = White)
- D & E — designates nominal ANSI CCT (value 40 = 4000K)

Therefore products tested and binned at 700mA follow the part numbering scheme:

L X M L - P W x 2, L X W x - P W x x and L X H 7 - P W x x

Average Lumen Maintenance Characteristics

Lumen maintenance for solid state lighting devices (LEDs) is typically defined in terms of the percentage of initial light output remaining after a specified period of time. Philips Lumileds projects that LUXEON Rebel ES products will deliver, on average, 70% lumen maintenance (L70) at 50,000 hours of operation at a forward current of 1000mA. This projection is based on constant current operation with junction temperature maintained at or below 135°C. This performance is based on independent test data, Philips Lumileds historical data from tests run on similar material systems, and internal LUXEON reliability testing. Observation of design limits included in this data sheet is required in order to achieve this projected lumen maintenance.

Environmental Compliance

Philips Lumileds is committed to providing environmentally friendly products to the solid-state lighting market. LUXEON Rebel ES is compliant to the European Union directives on the restriction of hazardous substances in electronic equipment, namely the RoHS and REACH directives. Philips Lumileds will not intentionally add the following restricted materials to the LUXEON Rebel ES: lead, mercury, cadmium, hexavalent chromium, polybrominated biphenyls (PBB) or polybrominated diphenyl ethers (PBDE).

Product Selection Guide for LUXEON Rebel ES

Thermal Pad Temperature = 25°C

Table 1.

Performance at Test Current (700mA)				
Nominal CCT/Color	Part Number	Minimum CRI	Typical CRI	Min Luminous Flux (lm) ^[1]
4100K Neutral White	LXML-PWN2	60	65	200
5650K Cool White	LXML-PWC2	60	70	200
2700K	LXW9-PW27	90	95	120
3000K	LXW9-PW30	90	95	140
3500K	LXW8-PW35	80	85	160
4000K	LXH7-PW40	70	75	180
4000K	LXW8-PW40	80	85	170
5000K	LXW8-PW50	80	85	180

Note for Table 1:

1. Minimum luminous flux performance within published operating conditions. Philips Lumileds maintains a tolerance of $\pm 6.5\%$ on luminous flux measurements and ± 2 on CRI measurements.

Typical Luminous Flux Characteristics at 350mA, 700mA and 1000mA for LUXEON Rebel ES, Thermal Pad Temperature = 25°C

Table 2.

Nominal CCT/Color	Part Number	Typical Luminous Flux (lm) @ 350mA Forward Current ^[1]	Typical Luminous Flux (lm) @ 700mA Forward Current ^[1]	Typical Luminous Flux (lm) @ 1000mA Forward Current ^[1]
4100K Neutral White	LXML-PWN2	130	230	310
5650K Cool White	LXML-PWC2	135	235	320
2700K	LXW9-PW27	75	135	184
3000K	LXW9-PW30	81	145	197
3500K	LXW8-PW35	103	185	252
4000K	LXH7-PW40	114	205	279
4000K	LXW8-PW40	106	190	258
5000K	LXW8-PW50	111	200	272

Note for Table 2:

1. Typical luminous flux performance within published operating conditions. Philips Lumileds maintains a tolerance of $\pm 6.5\%$ on luminous flux measurements.

Optical Characteristics for LUXEON Rebel ES at Test Current ^[1]

Thermal Pad Temperature = 25°C

Table 3.

Part Number	Nominal CCT	Color Temperature CCT			Typ Total Included Angle ^[2] $\theta_{0.90V}$	Typ Viewing Angle ^[3] $2\theta_{1/2}$
		Minimum	Typical	Maximum		
LXML-PWN2	4100K Neutral White	3500K	4100K	4500K	160°	120°
LXML-PWC2	5650K Cool White	4500K	5650K	10000K	160°	120°
LXW9-PW27	2700K	2580K	2725K	2870K	160°	120°
LXW9-PW30	3000K	2870K	3045K	3220K	160°	120°
LXW8-PW35	3500K	3220K	3465K	3710K	160°	120°
LXH7-PW40	4000K	3710K	3985K	4260K	160°	120°
LXW8-PW40	4000K	3710K	3985K	4260K	160°	120°
LXW8-PW50	5000K	4745K	5028K	5311K	160°	120°

Notes for Table 3:

1. Test current is 700mA for all LXML-PWx2, LXWx-PWxx and LXH7-PWxx emitters.
2. Total angle at which 90% of total luminous flux is captured.
3. Viewing angle is the off axis angle from lamp centerline where the luminous intensity is 1/2 of the peak value.

Electrical Characteristics at 700mA for LUXEON Rebel ES

Thermal Pad Temperature = 25°C

Table 4.

Part Number	Nominal CCT/Color	Forward Voltage Vf ^[1] (V)			Typ. Temperature Coefficient of Forward Voltage ^[2] (mV/°C) $\Delta V_f / \Delta T_J$	Typical Thermal Resistance Junction to Thermal Pad (°C/W) $R\theta_{J-c}$
		Minimum	Typical	Maximum		
LXML-PWN2	4100K Neutral White	2.5	2.90	3.25	-2.0 to -4.0	6
LXML-PWC2	5650K Cool White	2.5	2.90	3.25	-2.0 to -4.0	6
LXW9-PW27	2700K	2.5	2.90	3.25	-2.0 to -4.0	6
LXW9-PW30	3000K	2.5	2.90	3.25	-2.0 to -4.0	6
LXW8-PW35	3500K	2.5	2.90	3.25	-2.0 to -4.0	6
LXH7-PW40	4000K	2.5	2.90	3.25	-2.0 to -4.0	6
LXW8-PW40	4000K	2.5	2.90	3.25	-2.0 to -4.0	6
LXW8-PW50	5000K	2.5	2.90	3.25	-2.0 to -4.0	6

Notes for Table 4:

1. Philips Lumileds maintains a tolerance of $\pm 0.06V$ on forward voltage measurements.
2. Measured between 25°C = T_J = 110°C at I_f = 700mA.

Typical Electrical Characteristics at 350mA, 700mA and 1000mA for LUXEON Rebel ES

Thermal Pad Temperature = 25°C

Table 5.

Nominal CCT/Color	Part Number	Typical Forward Voltage V_f (V) @ 350mA Forward Current	Typical Forward Voltage V_f (V) @ 700mA Forward Current	Typical Forward Voltage V_f (V) @ 1000mA Forward Current
4100K Neutral White	LXML-PWN2	2.75	3.00	3.10
5650K Cool White	LXML-PWC2	2.75	3.00	3.10
2700K	LXW9-PW27	2.75	3.00	3.10
3000K	LXW9-PW30	2.75	3.00	3.10
3500K	LXW8-PW35	2.75	3.00	3.10
4000K	LXH7-PW40	2.75	3.00	3.10
4000K	LXW8-PW40	2.75	3.00	3.10
5000K	LXW8-PW50	2.75	3.00	3.10

Notes for Table 5:

1. Philips Lumileds maintains a tolerance of $\pm 0.06V$ on forward voltage measurements.

Absolute Maximum Ratings

Table 6.

Parameter	LUXEON Rebel ES
DC Forward Current (mA)	1000 ^[2]
Peak Pulsed Forward Current (mA)	1200 ^[3]
ESD Sensitivity	< 8000V Human Body Model (HBM) Class 3A JESD22-A114-E
LED Junction Temperature ^[1]	150°C
Operating Case Temperature at 700mA	-40°C - 135°C
Storage Temperature	-40°C - 135°C
Soldering Temperature	JEDEC 020c 260°C
Allowable Reflow Cycles	3
Reverse Voltage (Vr)	LUXEON Rebel ES LEDs are not designed to be driven in reverse bias

Notes for Table 6:

1. Proper current derating must be observed to maintain junction temperature below the maximum. For additional information on thermal measurement guidelines please refer to Application Brief AB33.
2. Residual periodic variations due to power conversion from alternating current (AC) to direct current (DC), also called 'ripple', with frequencies ≥ 100 Hz and amplitude ≤ 200 mA are acceptable, assuming the average current throughout each cycle does not exceed 1000 mA.
3. Pulsed operation with a peak drive current of 1200mA is acceptable if the pulse on-time is ≤ 5 ms per cycle and the duty cycle is $\leq 50\%$.

JEDEC Moisture Sensitivity

Table 7.

Level	Floor Life		Soak Requirements Standard	
	Time	Conditions	Time	Conditions
1	unlimited	$\leq 30^\circ\text{C} /$ 85% RH	168h + 5 / - 0	85°C / 85% RH

Reflow Soldering Characteristics

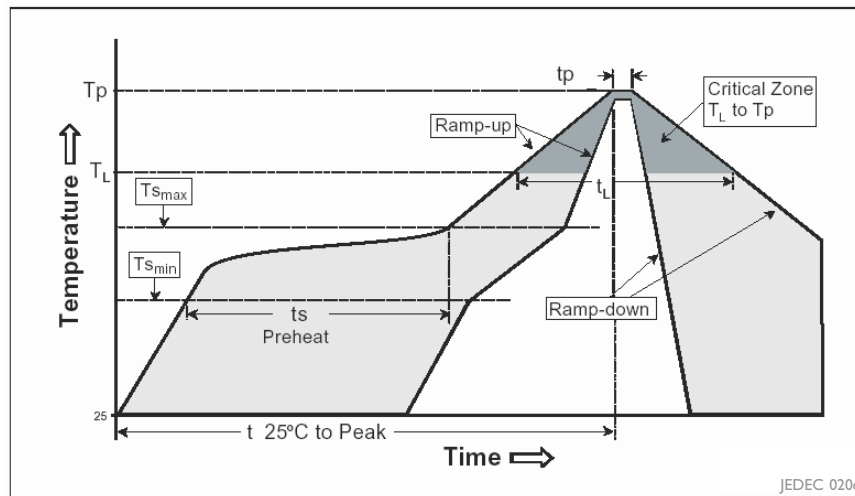

Temperature profile for Table 8.

Table 8.

Profile Feature	Lead Free Assembly
Average Ramp-Up Rate ($T_{s_{max}}$ to T_p)	3°C / second max
Preheat Temperature Min ($T_{s_{min}}$)	150°C
Preheat Temperature Max ($T_{s_{max}}$)	200°C
Preheat Time ($t_{s_{min}}$ to $t_{s_{max}}$)	60 - 180 seconds
Temperature (T_L)	217°C
Time Maintained Above Temperature (T_L)	60 - 150 seconds
Peak / Classification Temperature (T_p)	260°C
Time Within 5°C of Actual Peak Temperature (t_p)	20 - 40 seconds
Ramp - Down Rate	6°C / second max
Time 25°C to Peak Temperature	8 minutes max

Notes for Table 8:

1. All temperatures refer to the application Printed Circuit Board (PCB), measured on the surface adjacent to the package body.
2. For additional information on thermal measurement guidelines please refer to Application Brief AB33.

Mechanical Dimensions

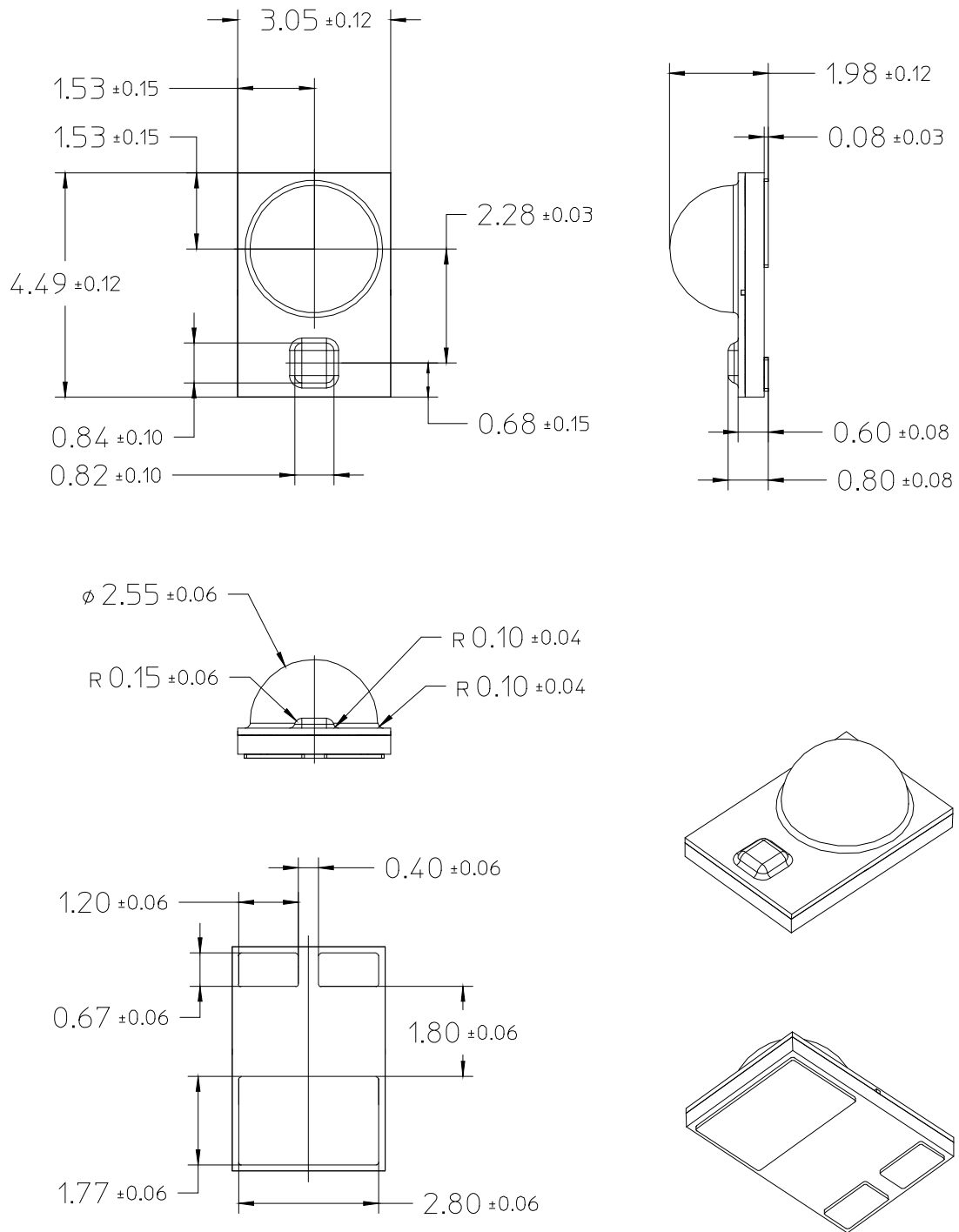
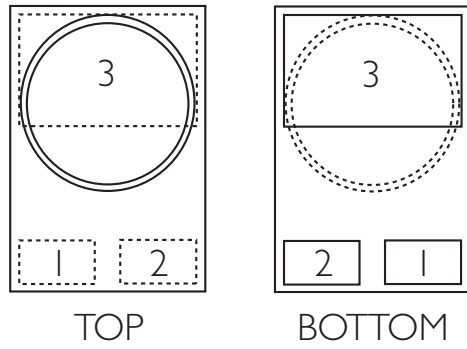

Figure 1. Package outline drawing.

Notes for Figure 1:

1. Do not handle the device by the lens—care must be taken to avoid damage to the lens or the interior of the device that can be damaged by excessive force to the lens.
2. Drawings not to scale.
3. All dimensions are in millimeters.
4. The thermal pad is electrically isolated from the anode and cathode contact pads.

Pad Configuration



PAD	FUNCTION
1	CATHODE
2	ANODE
3	THERMAL

Figure 2. Pad configuration.

Note for Figure 2:

1. The Thermal Pad is electrically isolated from the Anode and Cathode contact pads.

Solder Pad Design

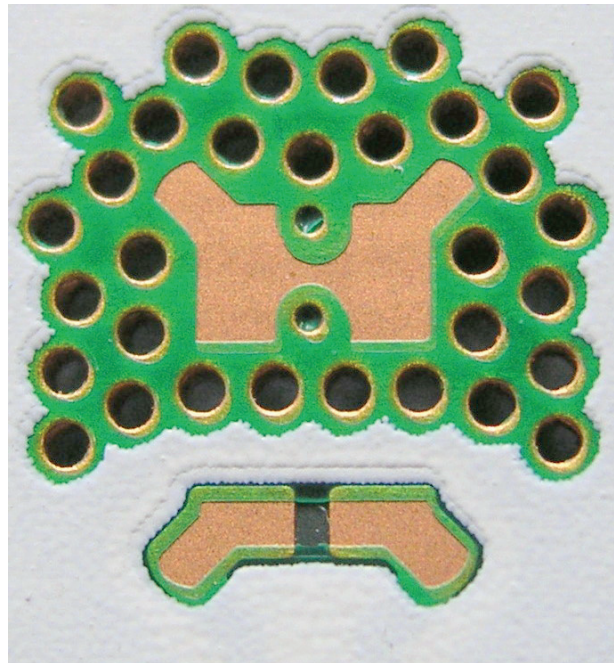

Figure 3. Solder pad layout.

Notes for Figure 3:

1. The photograph shows the recommended LUXEON Rebel ES layout on Printed Circuit Board (PCB). This design easily achieves a thermal resistance of 7K/W.
2. Application Brief AB32 provides extensive details for this layout. Printed Circuit Board layout files (.dwg) are available at www.philipslumileds.com and www.philipslumileds.cn.com.

Relative Spectral Distribution vs. Wavelength Characteristics

LXML-PWN2 (4100K) Neutral-White at Test Current
Thermal Pad Temperature = 25°C

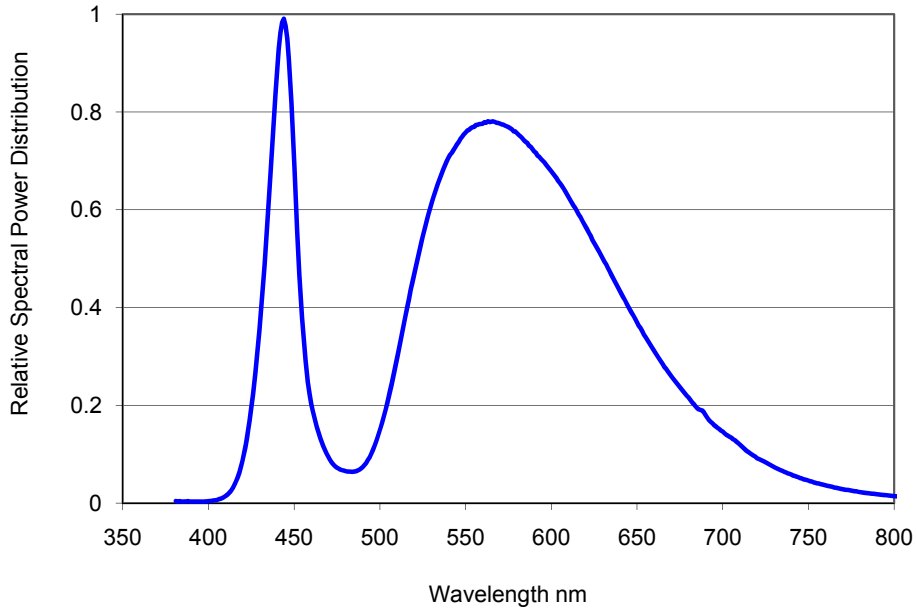

Figure 4. Color spectrum of LXML-PWN2 emitter, integrated measurement.

LXML-PWC2 (5650K) Cool-White at Test Current
Thermal Pad Temperature = 25°C

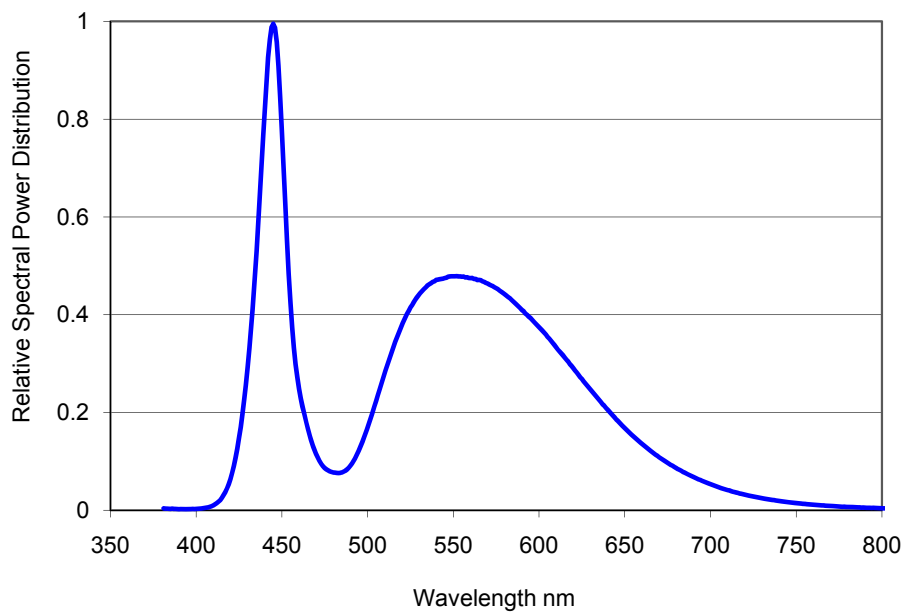

Figure 5. Color spectrum of LXML-PWC2 emitter, integrated measurement.

LXW9-PW27 (2700K) at Test Current, Thermal Pad Temperature = 25°C

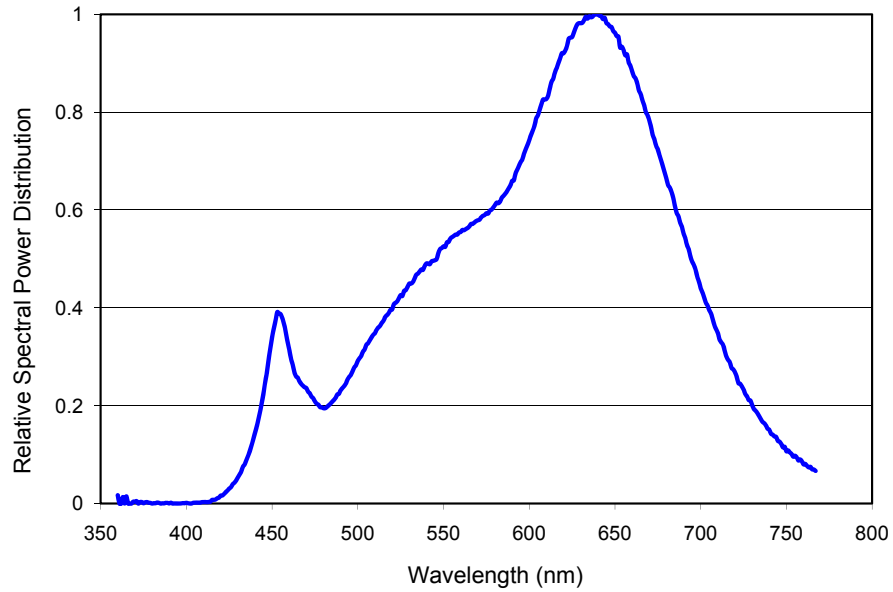

Figure 6. Color spectrum of LXW9-PW27 emitter, integrated measurement.

LXW9-PW30 (3000K) at Test Current, Thermal Pad Temperature = 25°C

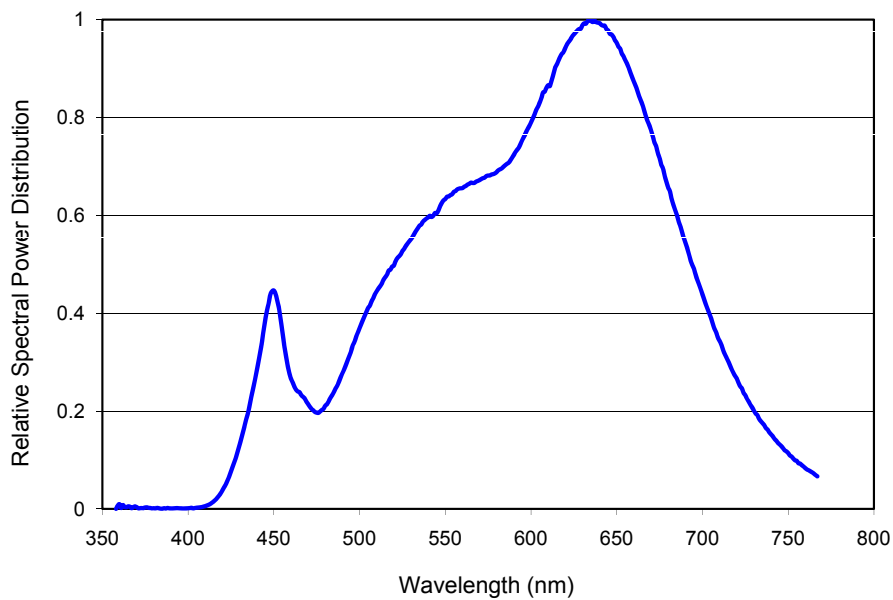

Figure 7. Color spectrum of LXW9-PW30 emitter, integrated measurement.

LXW8-PW35 (3500K) at Test Current, Thermal Pad Temperature = 25°C

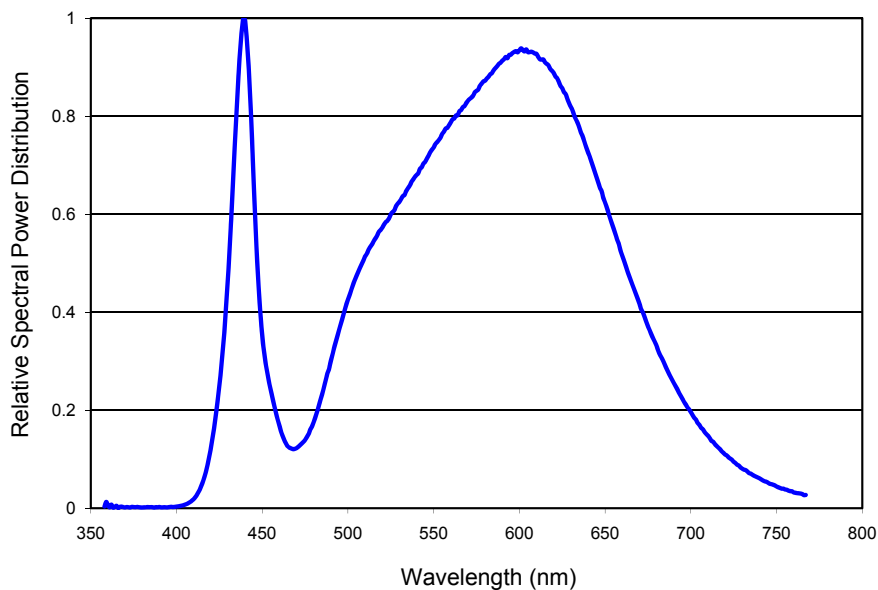

Figure 8. Color spectrum of LXW8-PW35 emitter, integrated measurement.

LXH7-PW40 (4000K) at Test Current, Thermal Pad Temperature = 25°C

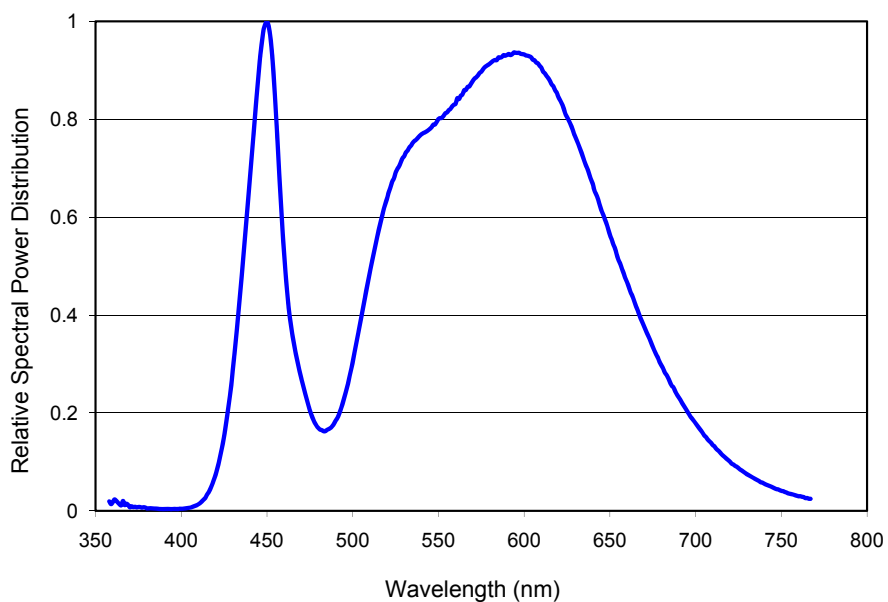

Figure 9. Color spectrum of LXH7-PW40 emitter, integrated measurement.

LXW8-PW40 (4000K) at Test Current, Thermal Pad Temperature = 25°C

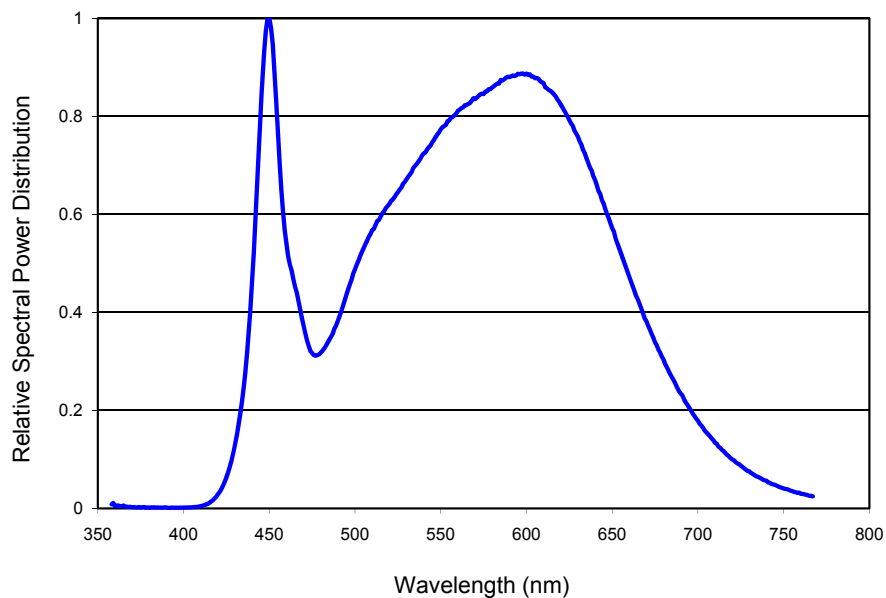

Figure 10. Color spectrum of LXW8-PW40 emitter, integrated measurement.

LXW8-PW50 (5000K) at Test Current, Thermal Pad Temperature = 25°C

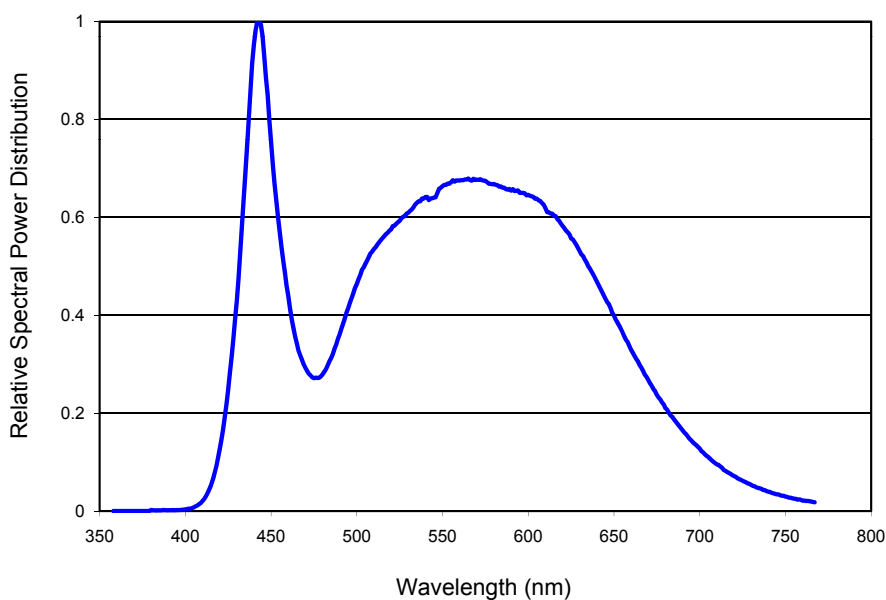

Figure 11. Color spectrum of LXW8-PW50 emitter, integrated measurement.

Typical Light Output Characteristics

Typical Relative Luminous Flux Vs. Temperature for LUXEON Rebel ES Emitters at Test Current

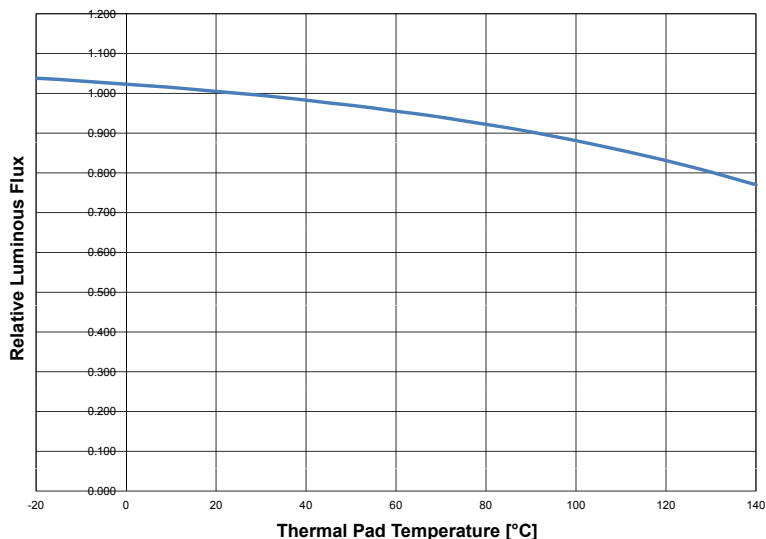

Figure 12. Relative light output vs. thermal pad temperature.

Typical Forward Current Characteristics

4100K Neutral White, 5650K Cool White, 2700K, 3000K, 3500K, 4000K and 5000K at Test Current, Thermal Pad Temperature = 25°C

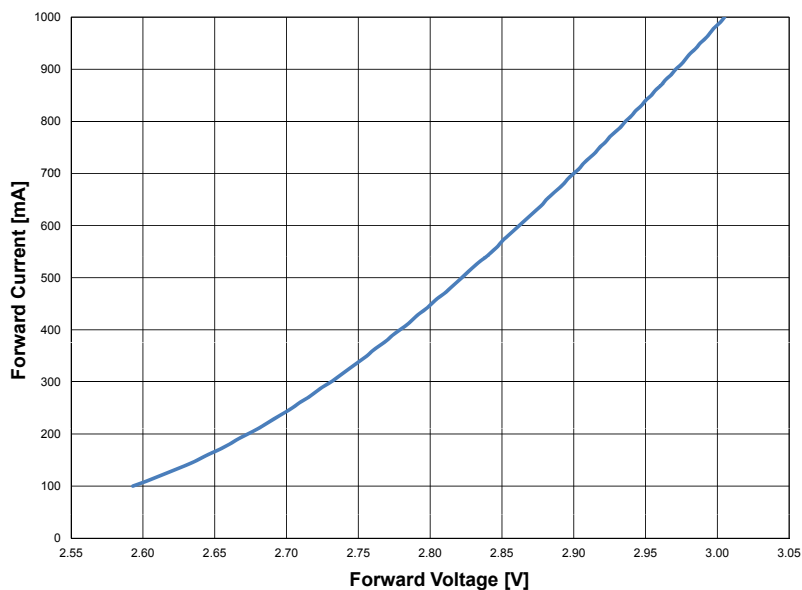

Figure 13. Forward current vs. forward voltage.

Typical Luminous Efficacy

Typical Luminous Efficacy Characteristic vs. Forward Current for 4100K Neutral White, 5650K Cool White, 2700K, 3000K, 3500K, 4000K and 5000K Emitters

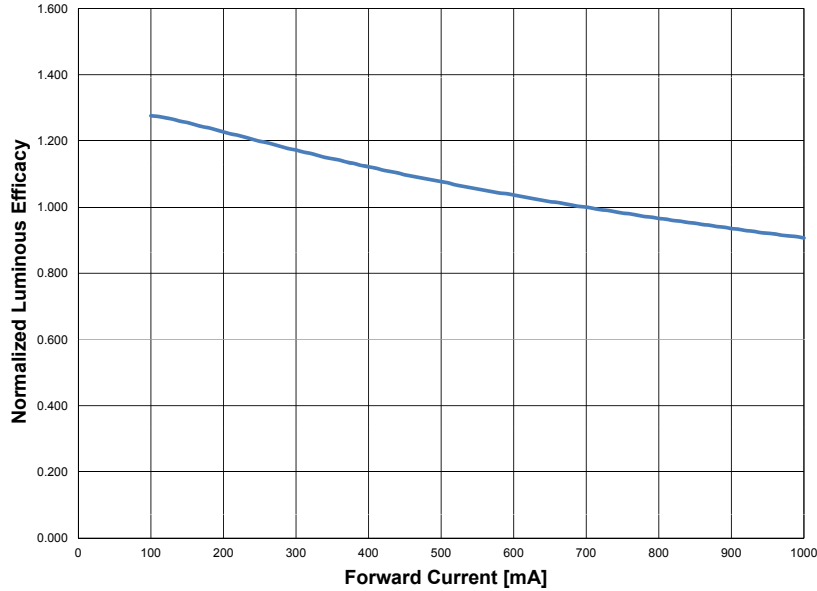

Figure 14. Typical luminous efficacy characteristic vs. forward current, thermal pad temperature = 25°C.

Typical Relative Luminous Flux vs. Forward Current for 4100K Neutral White, 5650K Cool White, 2700K, 3000K, 3500K, 4000K and 5000K Emitters. Thermal Pad Temperature = 25°C

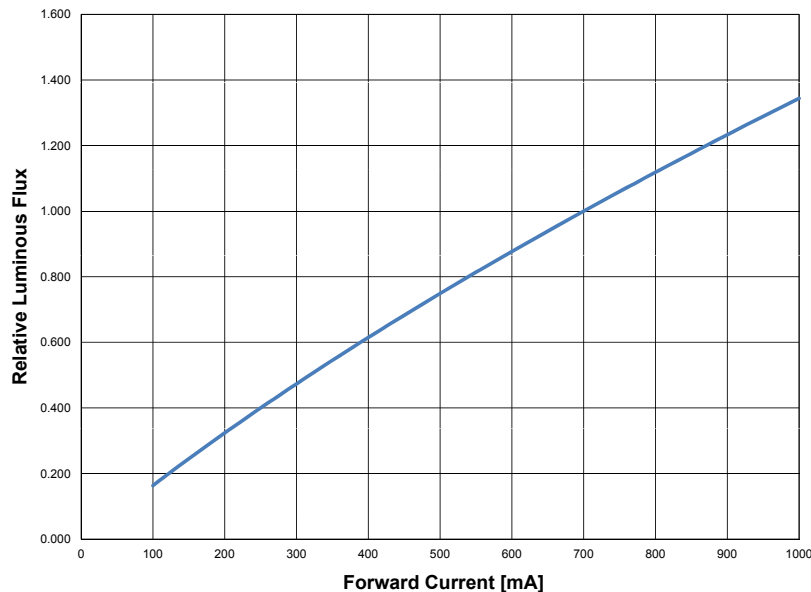

Figure 15. Typical relative luminous flux vs. forward current, thermal pad temperature = 25°C.

Typical Relative Luminous Efficacy vs. Temperature

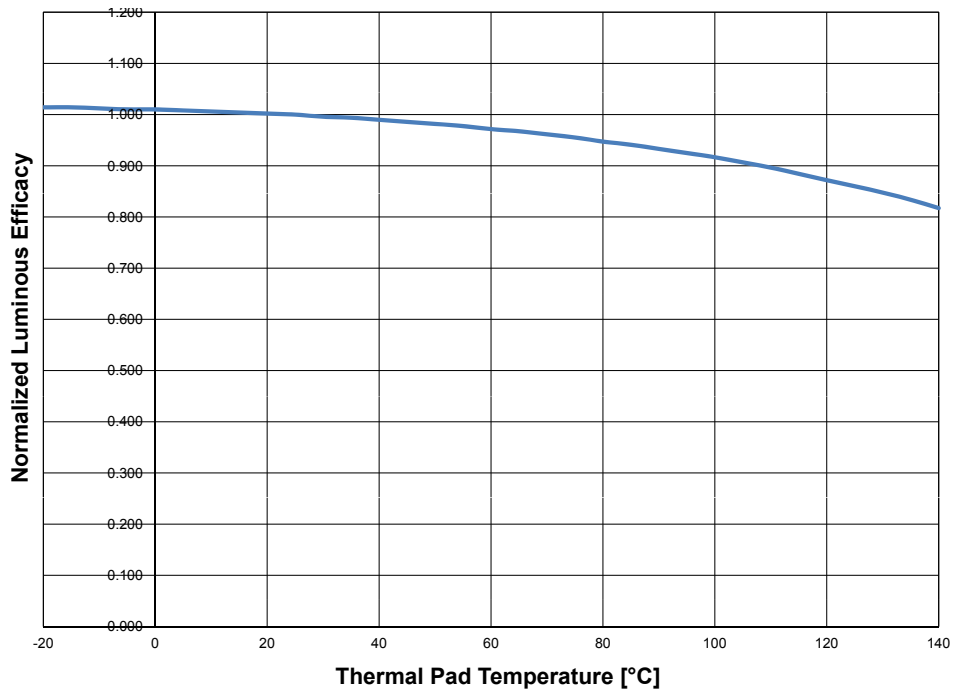

Figure 16. Relative luminous efficacy vs. thermal pad temperature, test current 700mA.

Current Derating Curves

Current Derating Curves at 350mA Forward Current Operation for 4100K Neutral White, 5650K Cool White, 2700K, 3000K, 3500K, 4000K and 5000K Emitters

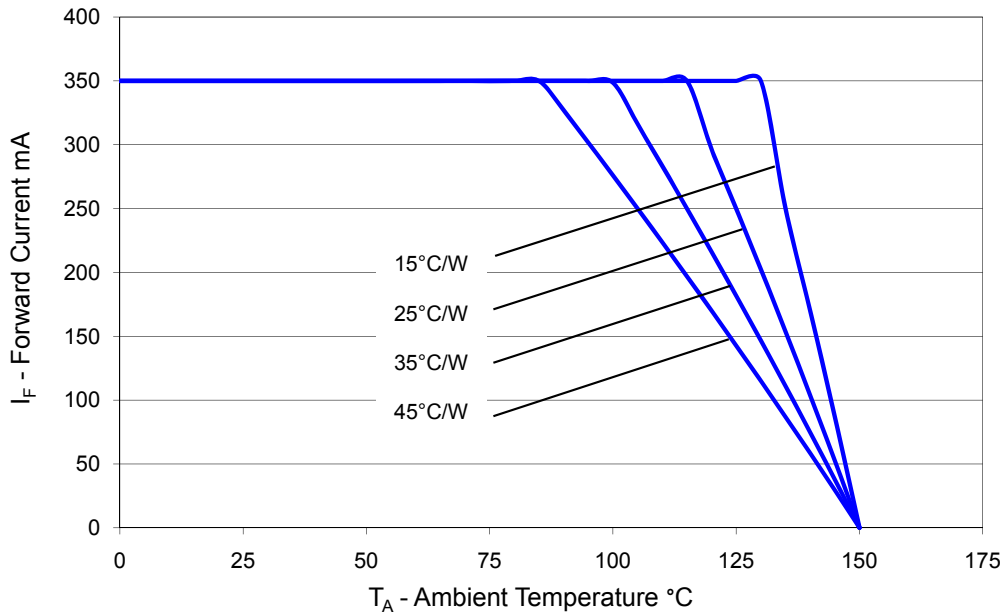

Figure 17. Maximum forward current vs. ambient temperature, based on $T_{JMAX} = 150^\circ\text{C}$.

Current Derating Curves at 700mA Forward Current Operation for 4100K Neutral White, 5650K Cool White, 2700K, 3000K, 3500K, 4000K and 5000K Emitters

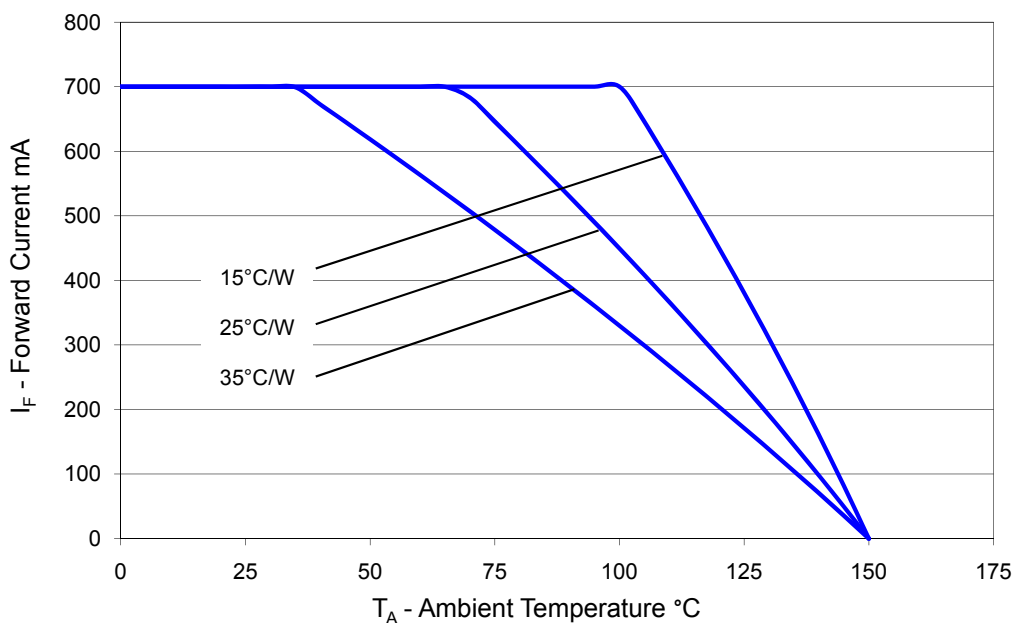

Figure 18. Maximum forward current vs. ambient temperature, based on $T_{JMAX} = 150^\circ\text{C}$.

Current Derating Curves at 1000mA Forward Current Operation for 4100K Neutral White, 5650K Cool White, 2700K, 3000K, 3500K, 4000K and 5000K Emitters

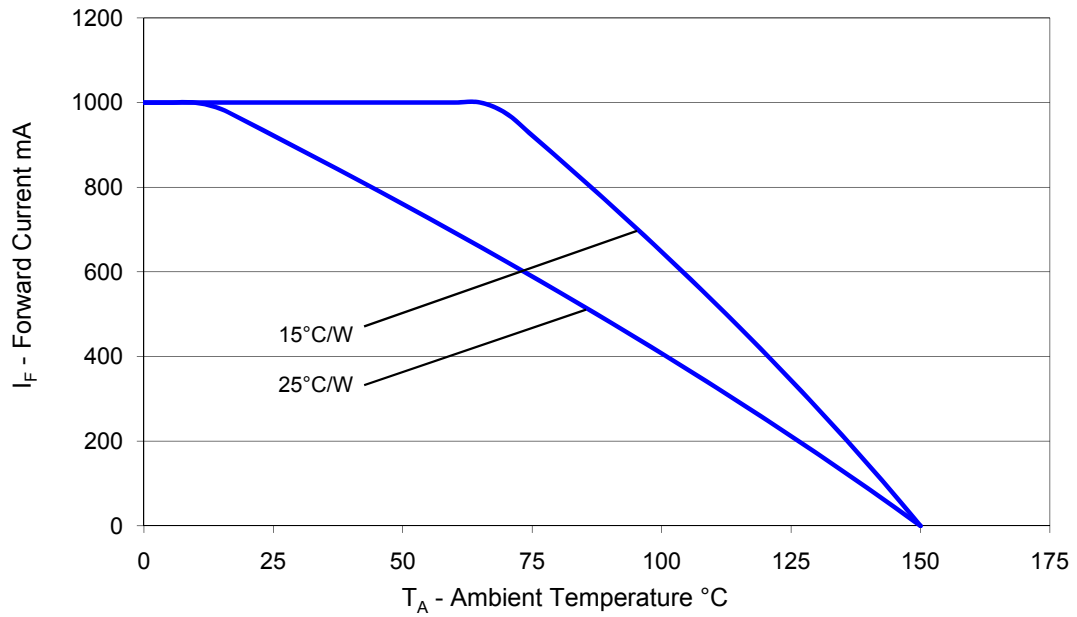

Figure 19. Maximum forward current vs. ambient temperature, based on $T_{JMAX} = 150^\circ\text{C}$.

Typical Radiation Pattern

Typical Spatial Radiation Pattern for 4100K Neutral White, 5650K Cool White, 2700K, 3000K, 3500K, 4000K and 5000K Emitters

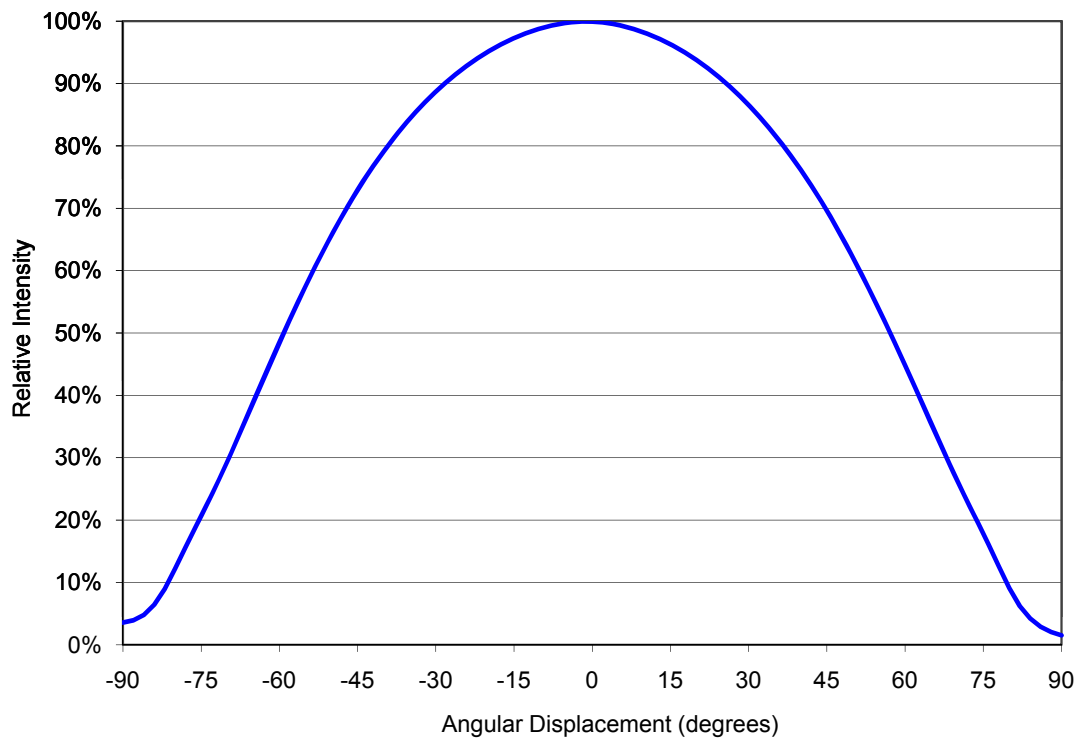
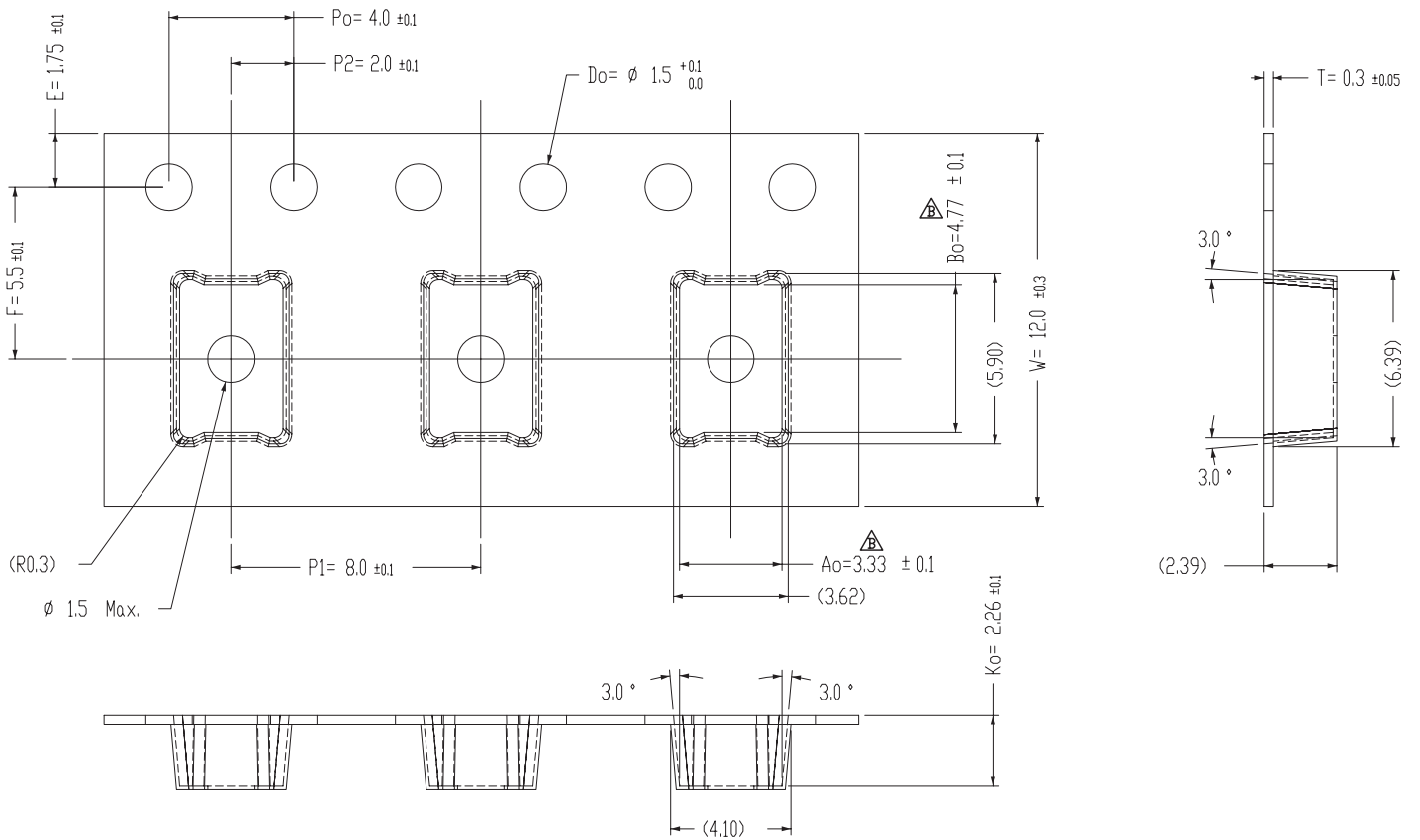
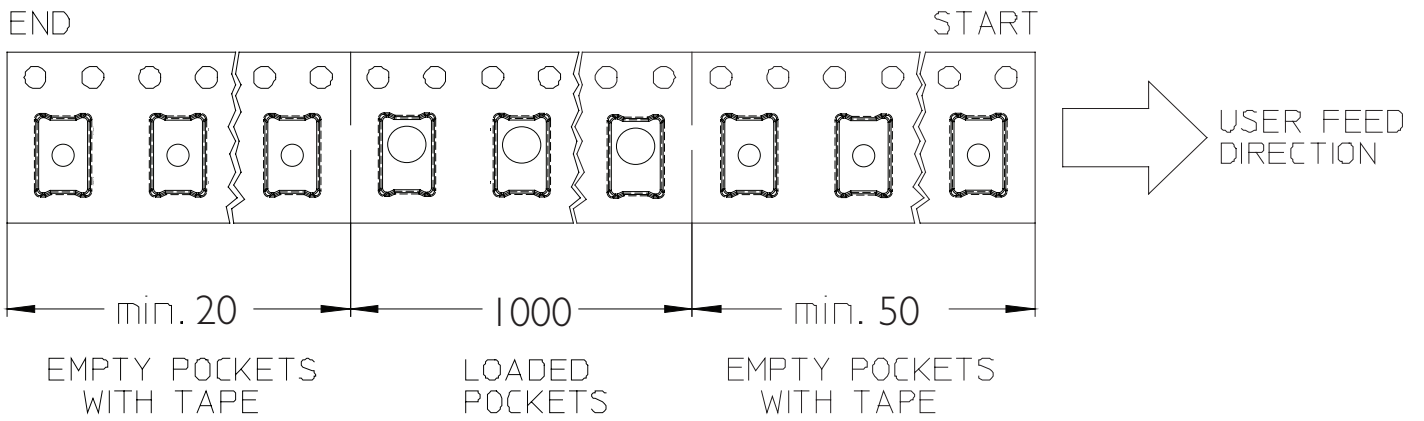
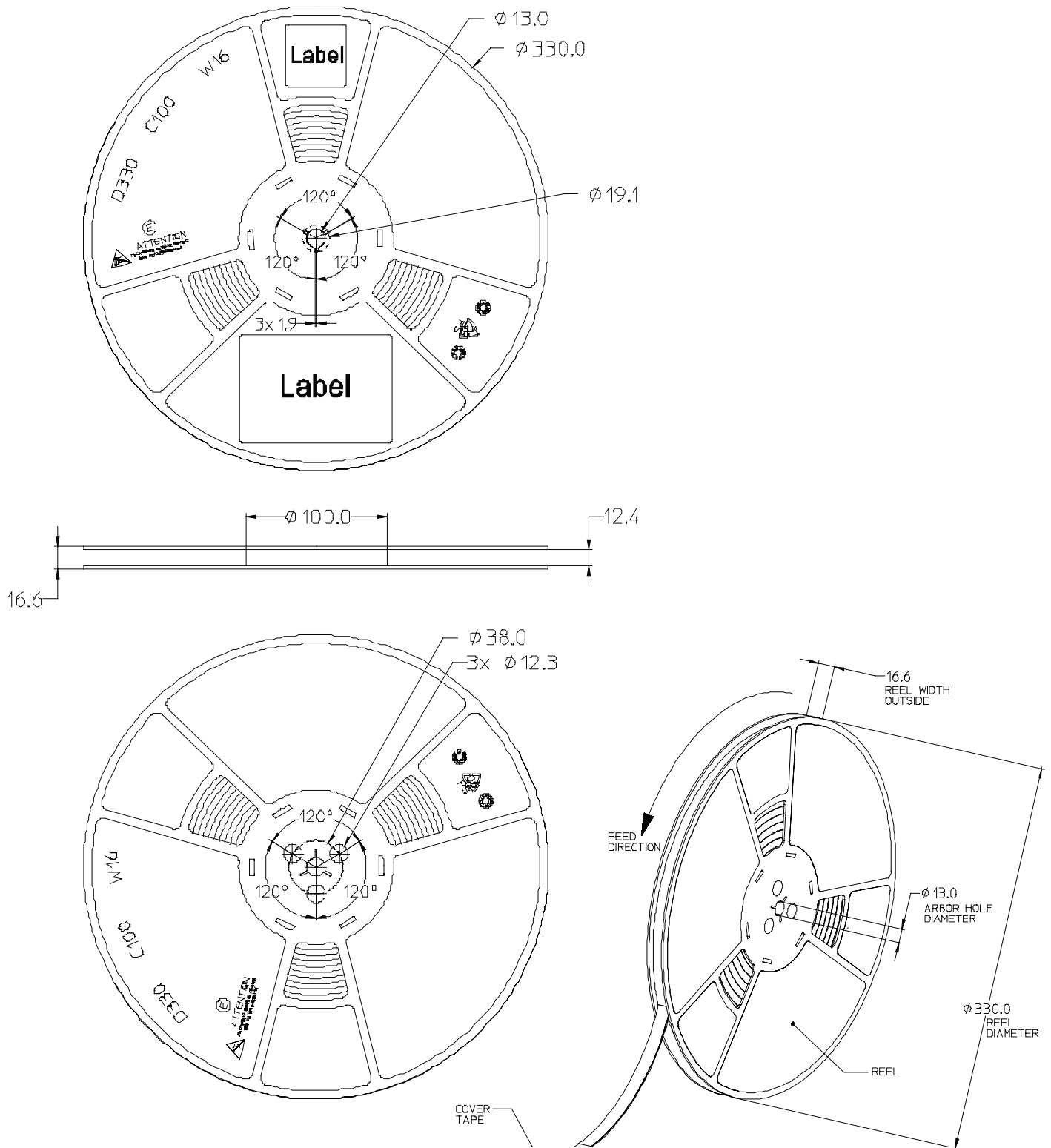

Figure 20. Typical representative spatial radiation pattern for 4100K neutral white, 5650K cool white, 2700K, 3000K 3500K, 4000K and 5000K lambertian.

Emitter Pocket Tape Packaging



Emitter Reel Packaging



Product Binning and Labeling

Purpose of Product Binning

In the manufacturing of semiconductor products, there is a variation of performance around the average values given in the technical data sheets. For this reason, Philips Lumileds bins the LED components for luminous flux, color and forward voltage (V_f).

Decoding Product Bin Labeling

LUXEON Rebel ES emitters are labeled using a four digit alphanumeric code (CAT code) depicting the bin values for emitters packaged on a single reel. All emitters packaged within a reel are of the same 3-variable bin combination. Using these codes, it is possible to determine optimum mixing and matching of products for consistency in a given application.

Reels of LUXEON Rebel ES emitters are labeled with a four digit alphanumeric CAT code following the format below.
A B C D

- A = Flux bin (P, Q, R, S etc.)
- B & C = Color bin (W0, V0, U0 etc. for LXML-PWx2 series. 7A, 7B, 7C and 7D for LXWx-PWxx series. 5W, 5X, 5Y and 5Z for LXH7-PW40 emitter)
- D = V_f bin (P, R, S and T)

Luminous Flux Bins

Table 9 lists the standard photometric luminous flux bins for LUXEON Rebel ES emitters (tested and binned at 700mA).

Although several bins are outlined, product availability in a particular bin varies by production run and by product performance.

Not all bins are available in all colors.

Table 9. Flux Bins

Bin Code	Min Photometric Flux (lm)	Max Photometric Flux (lm)
P	120	140
Q	140	160
R	160*	180
S	180	200
T	200	220
U	220	240
V	240	260
W	260	280
X	280	300

* 170 lm for LXW8-PW4

Beginning in March 2013, LUXEON Rebel ES will transition to 10 lumen flux bins as shown in the table below. This transition may result in mixed shipments of old bin codes and new bin codes during calendar year 2013.

Table 10. Flux Bins

Bin Code	Min Photometric Flux (lm)	Max Photometric Flux (lm)
1	120	130
2	130	140
3	140	150
4	150	160
5	160	170
6	170	180
7	180	190
8	190	200
9	200	210
A	210	220
B	220	230
C	230	240
D	240	250
E	250	260
F	260	270
G	270	280
H	280	290
J	290	300
K	300	310
L	310	320

4100K Neutral White Bin Structure

4100K Neutral White LUXEON Rebel ES emitters are tested and binned by x,y coordinates. 12 Color Bins, CCT Range 3,500K to 4,500K.

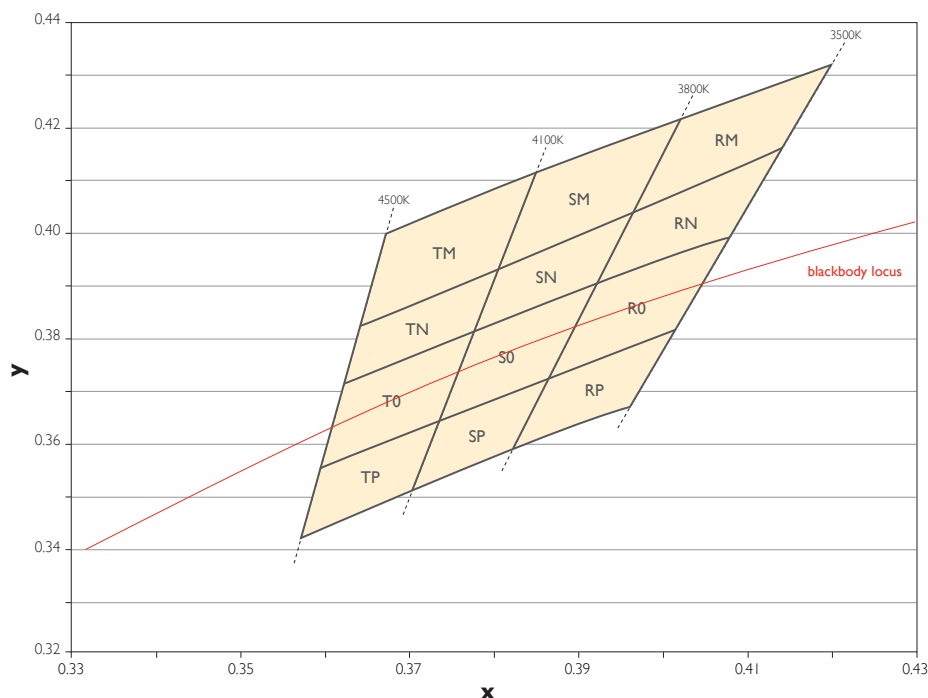

Figure 21. 4100K Neutral White bin structure.

Table 11. 4100K Neutral White Bin Coordinates

Bin Code	x	y	Typical CCT (K)	Bin Code	x	y	Typical CCT (K)
TM	0.367294	0.400290	4300	SO	0.378264	0.382458	3950
	0.385953	0.412995			0.392368	0.390932	
	0.381106	0.393747			0.387071	0.373899	
	0.364212	0.382878			0.374075	0.365822	
TN	0.364212	0.382878	4300	SP	0.374075	0.365822	3950
	0.381106	0.393747			0.387071	0.373899	
	0.378264	0.382458			0.382598	0.359515	
	0.362219	0.371616			0.370582	0.351953	
TO	0.362219	0.371616	4300	RM	0.402270	0.422776	3650
	0.378264	0.382458			0.420940	0.432618	
	0.374075	0.365822			0.414776	0.416097	
	0.359401	0.355699			0.396279	0.403508	
TP	0.359401	0.355699	4300	RN	0.396279	0.403508	3650
	0.374075	0.365822			0.414776	0.416097	
	0.370582	0.351953			0.408593	0.399525	
	0.357079	0.342581			0.392368	0.390932	
SM	0.385953	0.412995	3950	RO	0.392368	0.390932	3650
	0.402270	0.422776			0.408593	0.399525	
	0.396279	0.403508			0.402113	0.382156	
	0.381106	0.393747			0.387071	0.373899	
SN	0.381106	0.393747	3950	RP	0.387071	0.373899	3650
	0.396279	0.403508			0.402113	0.382156	
	0.392368	0.390932			0.396564	0.367284	
	0.378264	0.382458			0.382598	0.359515	

Note for Table 11:

- Philips Lumileds maintains a tester tolerance of ± 0.005 on x, y color coordinates.

5650K Cool White Bin Structure

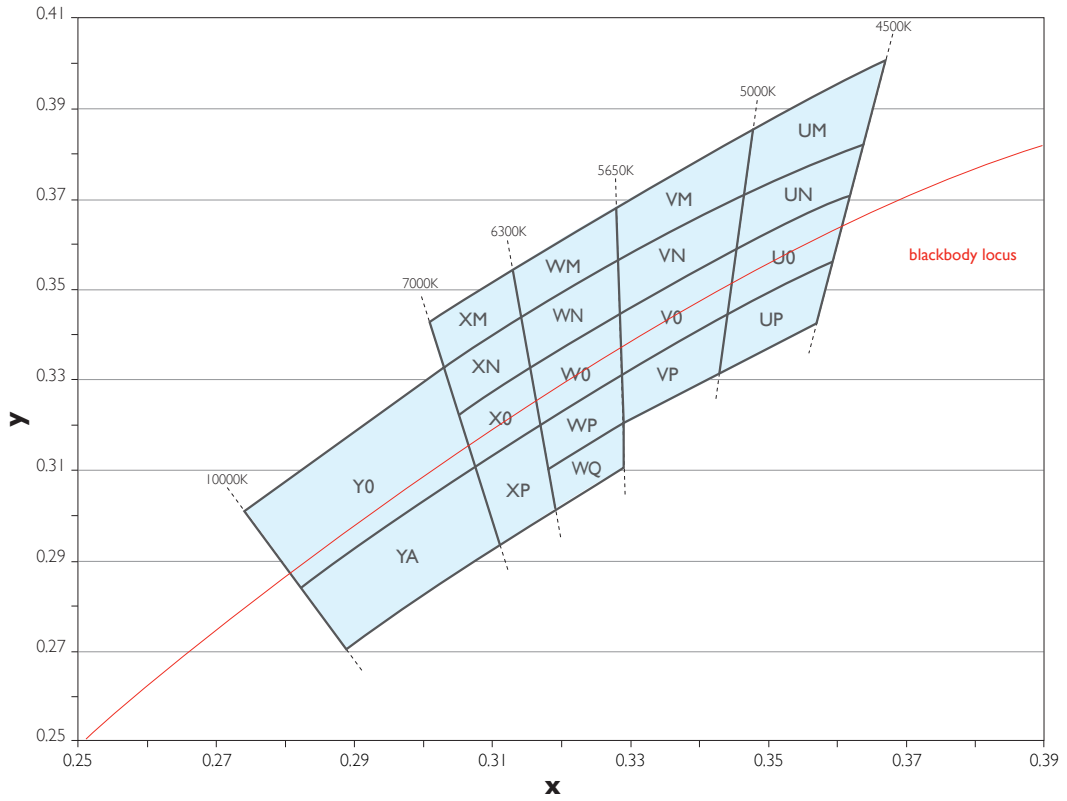

Figure 22. 5650K Cool White bin structure.

5650K Cool White LUXEON Rebel ES emitters are tested and binned by x,y coordinates. 19 Color Bins, CCT Range 4,500K to 10,000K.

Table 12. 5650K Cool White Bin Coordinates

Bin Code	x	y	Typical CCT (K)	Bin Code	x	y	Typical CCT (K)
Y0	0.274238 0.303051 0.307553 0.282968	0.300667 0.332708 0.310778 0.283772	8000	WQ	0.318606 0.329393 0.329544 0.319597	0.310201 0.320211 0.310495 0.301303	6000
YA	0.282968 0.307553 0.311163 0.289922	0.283772 0.310778 0.293192 0.270316	8000	VM	0.328636 0.348147 0.346904 0.328823	0.368952 0.385629 0.371742 0.356917	5300
XM	0.301093 0.313617 0.314792 0.303051	0.342244 0.354992 0.344438 0.332708	6700	VN	0.328823 0.346904 0.345781 0.329006	0.356917 0.371742 0.359190 0.345092	5300
XN	0.303051 0.314792 0.316042 0.305170	0.332708 0.344438 0.333222 0.322386	6700	VO	0.329006 0.345781 0.344443 0.329220	0.345092 0.359190 0.344232 0.331331	5300
XO	0.305170 0.316042 0.317466 0.307553	0.322386 0.333222 0.320438 0.310778	6700	VP	0.329220 0.344443 0.343352 0.329393	0.331331 0.344232 0.332034 0.320211	5300
XP	0.307553 0.317466 0.319597 0.311163	0.310778 0.320438 0.301303 0.293192	6700	UM	0.348147 0.367294 0.364212 0.346904	0.385629 0.400290 0.382878 0.371742	4750
WM	0.313617 0.328636 0.328823 0.314792	0.354992 0.368952 0.356917 0.344438	6000	UN	0.346904 0.364212 0.362219 0.345781	0.371742 0.382878 0.371616 0.359190	4750
WN	0.314792 0.328823 0.329006 0.316042	0.344438 0.356917 0.345092 0.333222	6000	UO	0.345781 0.362219 0.359401 0.344443	0.359190 0.371616 0.355699 0.344232	4750
WO	0.316042 0.329006 0.329220 0.317466	0.333222 0.345092 0.331331 0.320438	6000	UP	0.344443 0.359401 0.357079 0.343352	0.344232 0.355699 0.342581 0.332034	4750
WP	0.317466 0.329220 0.329393 0.318606	0.320438 0.331331 0.320211 0.310201	6000				

Note for Table 12:

- Philips Lumileds maintains a tester tolerance of ± 0.005 on x, y color coordinates.

LUXEON Rebel ES ANSI 1/4th Quadrant Color Bin Structure

ANSI 1/4th quadrant color bin structure for LXW9-PW27, LXW9-PW30, LXW8-PW35, LXW8-PW40 and LXW8-PW50 emitters

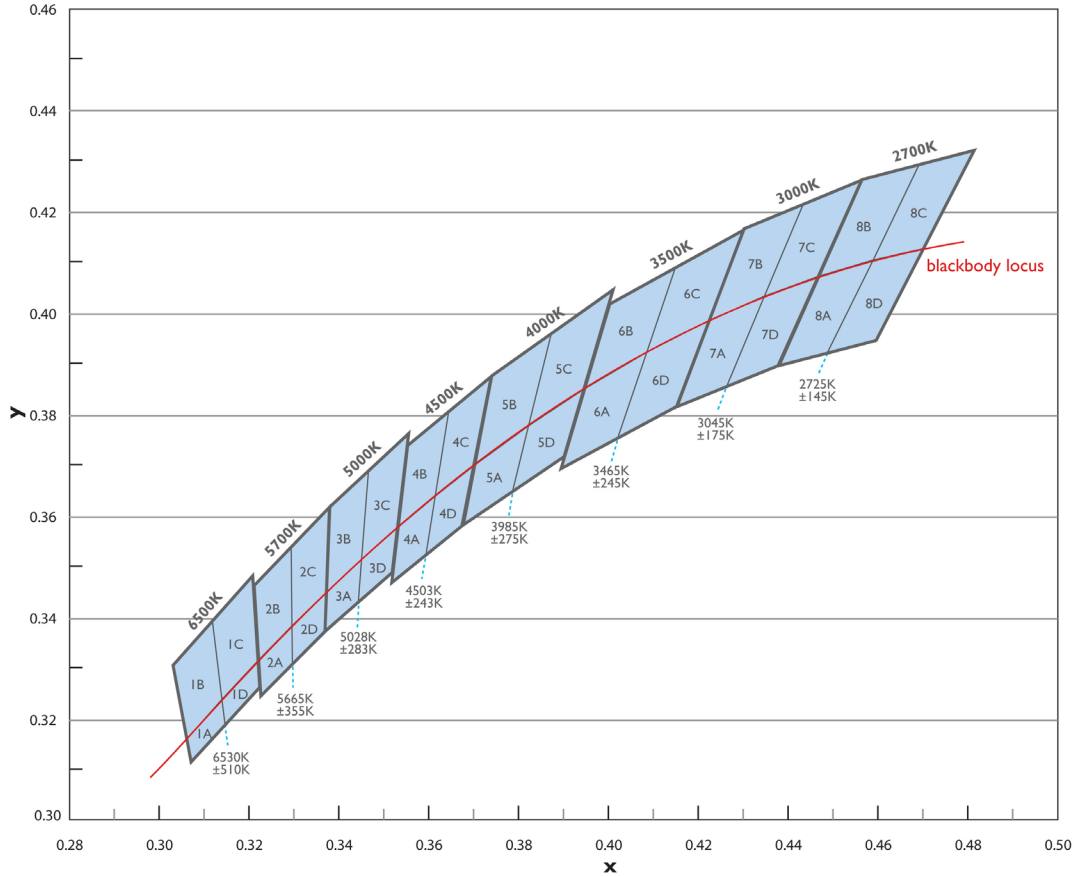

Figure 23. LUXEON Rebel ES ANSI 1/4th quadrant color bin structure.

LUXEON Rebel ES emitters are tested and binned by x,y coordinates.
32 Color Bins, CCT Range 2580K to 7040K

Table 13. LUXEON Rebel ES ANSI 1/4th quadrant Bin Coordinates

Nominal CCT	Bin Code	x	y	Nominal CCT	Bin Code	x	y
2700K	8A	0.458614	0.410315	3500K	6A	0.408216	0.392153
		0.446470	0.407117			0.394131	0.384815
		0.437300	0.389300			0.388900	0.369000
		0.448286	0.391847			0.401706	0.375155
2700K	8B	0.468732	0.428946	3500K	6B	0.414622	0.408937
		0.456200	0.426000			0.399600	0.401500
		0.446470	0.407117			0.394131	0.384815
		0.458614	0.410315			0.408216	0.392153
2700K	8C	0.481300	0.431900	3500K	6C	0.429900	0.416500
		0.468732	0.428946			0.414622	0.408937
		0.458614	0.410315			0.408216	0.392153
		0.469954	0.412602			0.422071	0.398417
2700K	8D	0.469954	0.412602	3500K	6D	0.422071	0.398417
		0.458614	0.410315			0.408216	0.392153
		0.448286	0.391847			0.401706	0.375155
		0.459300	0.394400			0.414700	0.381400
3000K	7A	0.434392	0.403186	4000K	5A	0.381883	0.377641
		0.422071	0.398417			0.369655	0.369740
		0.414700	0.381400			0.367000	0.357800
		0.425959	0.385336			0.378297	0.364637
3000K	7B	0.442994	0.421230	4000K	5B	0.386955	0.395809
		0.429900	0.416500			0.373600	0.387400
		0.422071	0.398417			0.369655	0.369740
		0.434392	0.403186			0.381883	0.377641
3000K	7C	0.456200	0.426000	4000K	5C	0.400600	0.404400
		0.442994	0.421230			0.386955	0.395809
		0.434392	0.403186			0.381883	0.377641
		0.446470	0.407117			0.394131	0.384815
3000K	7D	0.446470	0.407117	4000K	5D	0.394131	0.384815
		0.434392	0.403186			0.381883	0.377641
		0.425959	0.385336			0.378297	0.364637
		0.437300	0.389300			0.389800	0.371600
5000K	3A	0.344719	0.351301				
		0.336916	0.344873				
		0.336600	0.336900				
		0.343985	0.342749				
5000K	3B	0.346260	0.368726				
		0.337600	0.361600				
		0.336916	0.344873				
		0.344719	0.351301				
5000K	3C	0.355100	0.376000				
		0.346260	0.368726				
		0.344719	0.351301				
		0.352638	0.357500				
5000K	3D	0.352638	0.357500				
		0.344719	0.351301				
		0.343985	0.342749				
		0.351500	0.348700				

Notes for Table 13:

- Philips Lumileds maintains a tester tolerance of ± 0.005 on x, y color coordinates.
- Applicable for LXW9-PW27, LXW9-PW30, LXW8-PW35, LXW8-PW40 and LXW8-PW50 emitters.

LUXEON Rebel ES ANSI 1/4th Quadrant Bin Structure

ANSI 1/4th quadrant bin structure for LXH7-PW40 emitter

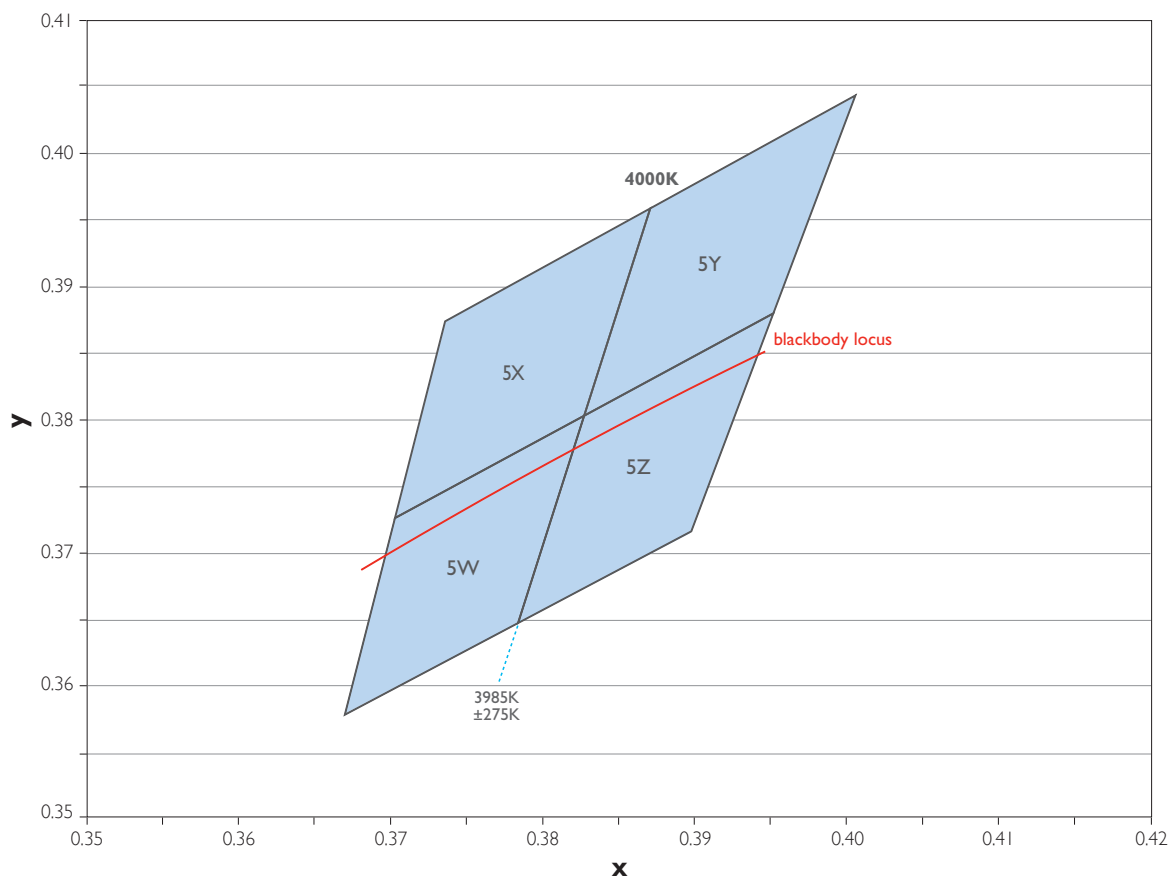

Figure 24. LUXEON Rebel ES ANSI 1/4th quadrant bin structure (LXH7-PW40 emitter only).

LUXEON Rebel ES emitters are tested and binned by x,y coordinates.
4 Color Bins, CCT Range 3710K to 4260K

Table 14. LUXEON Rebel ES ANSI 1/4th quadrant Bin Coordinates for LXH7-PW40 emitter

Nominal CCT	Bin Code	x	y
4000K	5W	0.382750	0.380300
		0.370300	0.372600
		0.367000	0.357800
		0.378400	0.364700
4000K	5X	0.382750	0.380300
		0.387100	0.395900
		0.373600	0.387400
		0.370300	0.372600
4000K	5Y	0.382750	0.380300
		0.395200	0.388000
		0.400600	0.404400
		0.387100	0.395900
4000K	5Z	0.382750	0.380300
		0.378400	0.364700
		0.389800	0.371600
		0.395200	0.388000

Forward Voltage Bins

Table 15 lists minimum and maximum V_f bin values per emitter (tested and binned at 700mA). Although several bins are outlined, product availability in a particular bin varies by production run and by product performance.

Table 15. V_f Bins

Bin Code	Minimum Forward Voltage (V)	Maximum Forward Voltage (V)
P	2.50	2.75
R	2.75	3.00
S	3.00	3.25
T	3.25	3.50

Who We Are

Philips Lumileds focuses on one goal: Creating the world's highest performing LEDs. The company pioneered the use of solid-state lighting in breakthrough products such as the first LED backlit TV, the first LED flash in camera phones, and the first LED daytime running lights for cars. Today we offer the most comprehensive portfolio of high quality LEDs and uncompromising service.

Philips Lumileds brings LED's qualities of energy efficiency, digital control and long life to spotlights, downlights, high bay and low bay lighting, indoor area lighting, architectural and specialty lighting as well as retrofit lamps. Our products are engineered for optimal light quality and unprecedented efficacy at the lowest overall cost. By offering LEDs in chip, packaged and module form, we deliver supply chain flexibility to the inventors of next generation illumination.

Philips Lumileds understands that solid state lighting is not just about energy efficiency. It is about elegant design. Reinventing form. Engineering new materials. Pioneering markets and simplifying the supply chain. It's about a shared vision. Learn more about our comprehensive portfolio of LEDs at www.philipslumileds.com.

Philips Lumileds Lighting Company shall not be liable for any kind of loss of data or any other damages, direct, indirect or consequential, resulting from the use of the provided information and data. Although Philips Lumileds Lighting Company has attempted to provide the most accurate information and data, the materials and services information and data are provided "as is" and Philips Lumileds Lighting Company neither warranties, nor guarantees the contents and correctness of the provided information and data. Philips Lumileds Lighting Company reserves the right to make changes without notice. You as user agree to this disclaimer and user agreement with the download or use of the provided materials, information and data.



©2014 Philips Lumileds Lighting Company. All rights reserved.
LUXEON is a registered trademark of the Philips Lumileds Lighting Company in the United States and other countries.

www.philipslumileds.com
www.philipslumileds.cn.com

LUXEON Rebel ES Datasheet DS61 20140630

X-ON Electronics

Largest Supplier of Electrical and Electronic Components

Click to view similar products for [opulent manufacturer](#):

Other Similar products are found below :

[STAR-LUXEON-ZES-24080-3](#) [CCK-XHP50-CK01](#) [REBEL STAR](#) [LUXEONZ-RGBA](#) [XPEPHR-L1-0000-00901-SB01](#) [XHP70A-0L-04-0D0BN450E](#) [LST1-01F04-5770-01](#) [LST1-01F04-5070-01](#) [LST1-01F04-3070-01](#) [XPERDO-L1-0000-00A01-SB01](#) [LST1-01F05-3070-01](#) [LST1-01F05-4070-01](#) [LST1-01G01-GRN1-00](#) [LVS1-04C05-2790-00](#) [LSR1-04C32-5070-00](#) [LSR1-12C32-5070-00](#) [LSR1-12C32-5770-00](#) [LVS1-04C05-4070-00](#) [LSR1-04C32-4070-00](#) [SSB1-72F16-3090-00](#) [SSB1-72F16-4090-00](#) [XHP35A-0R-08-0D0BE450E](#) [XHP70A-0L-02-0D0BN450E](#) [XHP50A-0L-02-0D0BJ450E](#) [XHP70A-0L-03-0D0BN450E](#) [LST1-01F05-5070-01](#) [LUXEONZ-4UP-MCPCB](#) [XHP50A-0S-04-0D0BJ440E](#) [XPLAWT-H0-0000-000BV20E5-SB01](#) [LST1-01C48-5770-01](#) [LST1-01F07-3070-01](#) [XHP35A-0R-08-0D0BE240E](#) [XPLAWT-00-0000-0000V60E1-SB01](#) [XPGDWT-B1-0000-00L5E-SB01](#) [LST1-01F07-5770-01](#) [LST1-01F05-5770-01](#) [LPS1-01C24-2790-00](#) [STAR-LG3535HP3W-35](#) [XHP50A-00-0000-0D0BJ440E-SB01](#) [LSS1-04C22-4070-00](#) [LST1-01C48-4080-01](#) [XHP35A-0R-04-0D0UB427E](#) [LST1-01C48-3580-01](#) [DSB1-66G02-3018-90-01](#) [XHP35A-0R-12-0D0UB427E](#) [XHP70A-0S-04-0D0BN240E](#) [STAR-LUXEON-ZES-25770](#) [XHP70A-0S-04-0D0BN450E](#) [LST1-01G01-UV02-00](#) [MHDGWT-0000-000N0HK427G-SB01](#)