

LXML-PWN1-0100 Luxeon Rebel Starboard LED

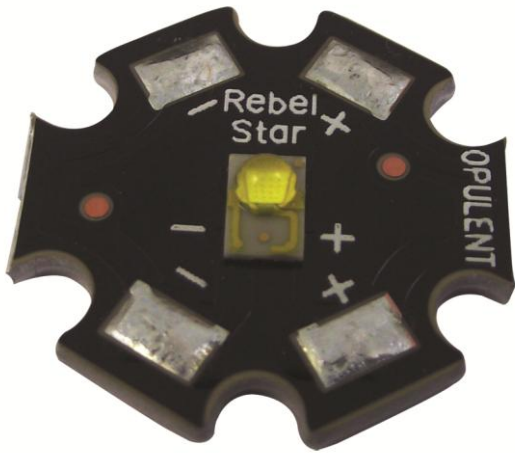

Opulent Part Number: REBEL-STAR-NW100

Opulent Starboard: MCPCB

Luxeon Rebel LED: LXML-PWN1-0100

Features

- Excellent thermal conductivity
- Excellent insulating ability
- Excellent Dimensional Stability
- Excellent Mechanical Strength
- Lower heat expansibility
- Lower operating temperature
- Increase power density
- Reduce the number of interconnects
- Extend the life of dies

OP REBEL STAR



OP REBEL STAR
ALUMINUM CLAD PRINTED
CIRCUIT BOARD FOR
LUXEON REBEL ALLOWS
OPTIMUM HEAT
DISSIPATION.



This is a custom MCPCB structure that further enhances heat dissipation and thus enabling the LED to last according to its life time.

Higher thermal conductive MCPCB is also available with our special enhanced capabilities.

CONSTRUCTION OF MCPCB

The structure of the aluminum material includes copper layer, dielectric layer laminated together with aluminum base layer. Below appends summary of available range of material:

Aluminum Type	Aluminum Thickness	Copper Thickness	Dielectric Thickness
AL 5052	1.5 mm	1 oz	0.100mm

PANEL DRAWING

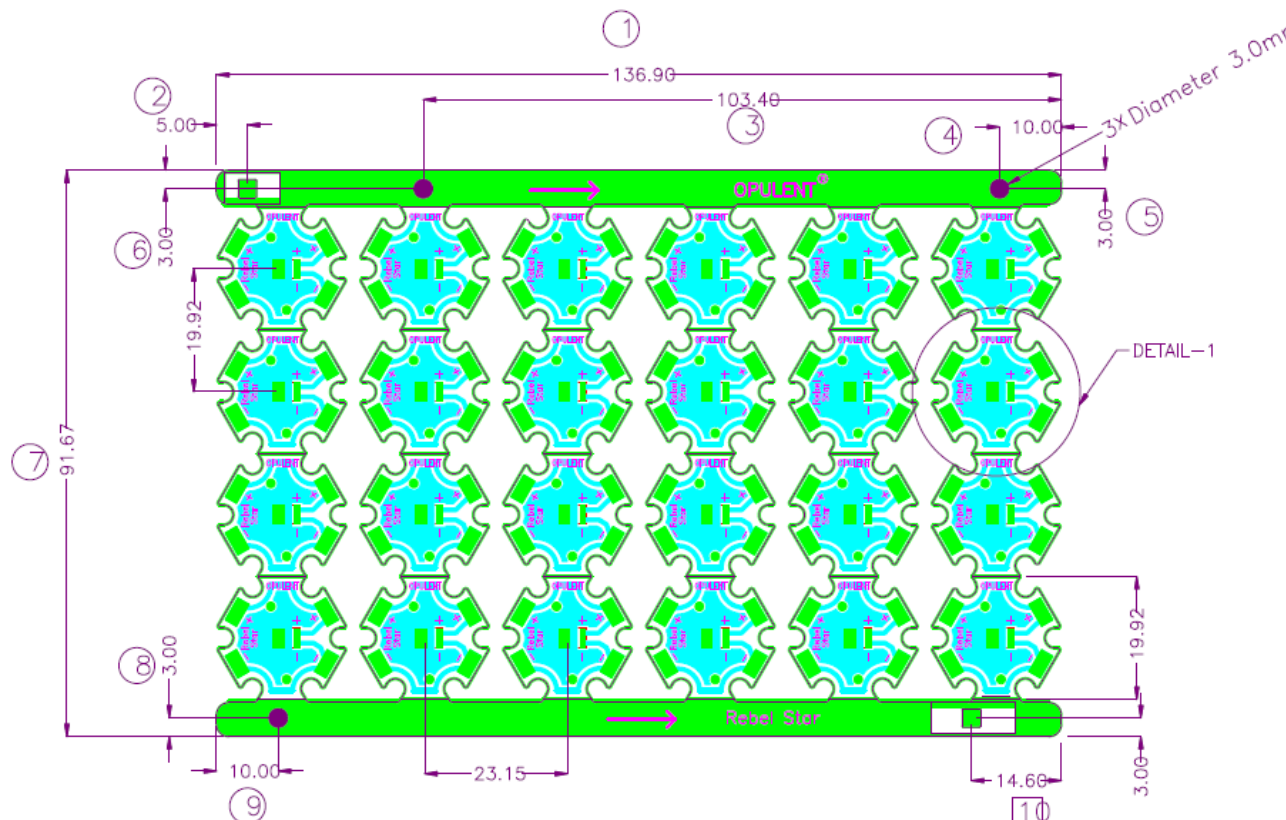

MATERIAL DATASHEET

Material Datasheet - OPT111.01.AI5215.4.0018			
	Treatment Condition	Value	Unit
Thermal Properties			
Thermal Conductivity (Dielectric layer)		1.8	W/m-k
Thermal Resistance (Dielectric layer)		0.086	°C-in ² /W
Maximum Operating Temperature	UL 746	125	°C
Glass Transition Temp (Tg)	DSC	130	°C
Coefficient of Thermal Expansion (CTE)	< Tg	21.5	x10 ⁻⁶ /°C
	> Tg	22.0	
Electrical Properties			
Dielectric constant	1kHz/1MHz	4.2	—
Dissipation Factor	1kHz/1MHz	0.02	—
Volume Resistivity	C-96/40/90	1×10 ⁸	MΩ·cm
Surface Resistivity	C-96/40/90	1×10 ⁷	MΩ
Dielectric Breakdown Voltage	A	30	KV/mm
Mechanical Properties			
Dielectric Thickness	A	100	μm
Peel Strength	A	1.05	N/mm
Chemical Properties			
Water absorption	D-24/23	0.09	%
Ratings and Durability			
UL Flammability		94 V-0	—
Comparative Tracking Index	IEC60112	600	V
Thermal stress	10 sec @ 288 °C, 3 cycles	Pass	—
Time to delamination	5min @ 260 °C	Pass	—

* The data is based on typical values of standard production and should be considered as general information. Our company reserves the right for future changes. It is the responsibility of the user to ensure that the product complies with his requirements.

PRODUCT SPECIFICATIONS

OP REBEL STAR MCPCB

Aluminum Type:	AL5052
Aluminum Thickness:	1.5mm
Copper Thickness:	1oz
Dielectric Thickness:	0.1mm
Unit Size:	21.38 x 19.92mm (±0.1mm)
Panel Size:	136.9 x 91.67mm (24pcs/pnl)
Finishing:	OSP
Solder Mask:	Glossy Black

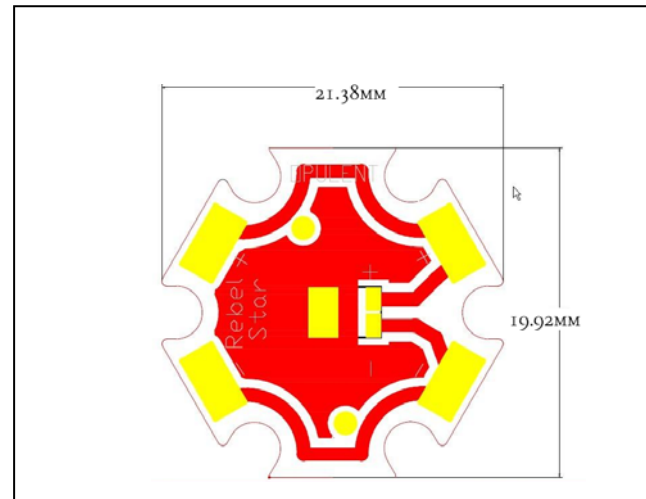

SOLDER PASTE

Type:	Leadfree SAC 305 paste, grade 3 or above
Lumileds Internal:	Alpha Metal OM325 grade 4
Alternative:	Alpha Metal OM338 grade 3

PACKAGING

One carton consists of 10 internal white boxes. Each white box consists of 3 trays. Each tray consists of 48 pieces.

Type of tray:	Individual slot for each OP Rebel Star
Cavity per tray:	48 pcs
Dimension of tray:	44.3cm x 17.25cm x 2.3cm
Internal White Box:	contains 3 trays with 1 cover tray (equivalent to 144pcs of OP Rebel)
Dimension of I.W.B:	44.8cm x 17.7cm x 5.5cm
Carton box:	contains 10 white boxes (equivalent to 1440pcs of OP Rebel Star)
Dimension of carton:	45.5cm x 36.4cm x 28.5cm

ABOUT OPULENT

Opulent (Asia)

Email: sales@opulent-group.com

Singapore ☎: +65 67498188 (Head Office)

Headquartered in Singapore, Opulent has more than 20 years experience in the manufacturing of conventional printed circuit boards (PCBs). Embarking for an international presence, Opulent has set up sales and marketing support in China, Hong Kong, Germany, Italy, United Kingdom and Malaysia.

Through innovation and R&D, Opulent created metal-clad PCBs (MCPCB) and is currently a leading designer and manufacturer of thermal solutions. Our products and works are guided by a customer centric approach that empowers us to provide value added solutions from design to assembly.

Our customers are well-known international brands whom have come to trust Opulent for our innovation, our knowledge and our commitment to attain customer satisfaction.



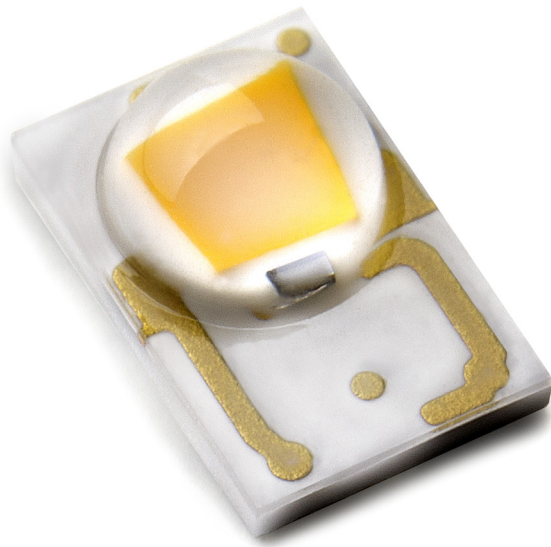

LUXEON Rebel
General Purpose White
Portfolio

*High flux
and color stability*

Technical Datasheet DS64



LUXEON Rebel

General Purpose White Portfolio

Cool-white/Neutral white

Introduction

The LUXEON® Rebel General Purpose White Portfolio LEDs in this datasheet are ideal for all lighting and illumination applications. These flux differentiated parts, like all other LUXEON Rebel LEDs, provide the industry's best lumen maintenance, superior reliability and quality white light that make them the most widely used power LEDs today. Using the information in this document you can start designing applications to your unique specifications.

LUXEON Rebel General Purpose White LEDs

- Deliver more usable light and higher flux density
- Optimize applications to reduce size and cost
- Tightly pack the LEDs for mixing
- Engineer more robust applications
- Utilize standard FR4 PCB technology
- Simplify manufacturing through the use of surface mount technology
- Recognized under the Component Recognition Program of Underwriters Laboratories Inc. UL listing E327436.

PHILIPS
LUMILEDS

Table of Contents

General Product Information.....	3
Product Nomenclature.....	3
Average Lumen Maintenance Characteristics	3
Environmental Compliance.....	3
Luminous Flux Characteristics.....	4
Flux Performance, Binning, and Supportability	4
Optical Characteristics	5
Electrical Characteristics.....	6
Absolute Maximum Ratings	7
JEDEC Moisture Sensitivity.....	7
Reflow Soldering Characteristics	8
Mechanical Dimensions	9
Pad Configuration.....	10
Solder Pad Design.....	10
Wavelength Characteristics.....	11
Typical Light Output Characteristics over Temperature.....	12
Typical Forward Current Characteristics.....	13
Typical Relative Luminous Flux	14
Current Derating Curves.....	15
Typical Radiation Patterns.....	17
Emitter Pocket Tape Packaging.....	18
Emitter Reel Packaging	19
Product Binning and Labeling	20
Luminous Flux Bins.....	21
Cool-White Bin Structure	22
Neutral-White Bin Structure	24
Forward Voltage Bins.....	25

General Product Information

Product Nomenclature

LUXEON Rebel is tested and binned at 350 mA, with current pulse duration of 20 ms. All characteristic charts where the thermal pad is kept at constant temperature (25°C typically) are measured with current pulse duration of 20 ms. Under these conditions, junction temperature and thermal pad temperature are the same.

The part number designation is explained as follows:

L X M L - A B C D - E F G H

Where:

- A — designates radiation pattern (value P for Lambertian)
- B — designates color (W = White)
- C — designates tint variant (C = Cool-White or N = Neutral-White)
- D — designates test current (value I for 350 mA)
- E — reserved for future product offerings
- FGH — minimum luminous flux (lm)

Therefore products tested and binned at 350 mA follow the part numbering scheme:

L X M L - P W x I - 0 x x x

Average Lumen Maintenance Characteristics

Lumen maintenance for solid-state lighting devices (LEDs) is typically defined in terms of the percentage of initial light output remaining after a specified period of time. Philips Lumileds projects that LUXEON Rebel products will deliver, on average, 70% lumen maintenance (L70) at 50,000 hours of operation at a forward current of up to 700 mA. This projection is based on constant current operation with junction temperature maintained at or below 135°C. This performance is based on independent test data, Philips Lumileds historical data from tests run on similar material systems, and internal LUXEON reliability testing. Observation of design limits included in this data sheet is required in order to achieve this projected lumen maintenance.

Environmental Compliance

Philips Lumileds is committed to providing environmentally friendly products to the solid-state lighting market. LUXEON Rebel is compliant to the European Union directives on the restriction of hazardous substances in electronic equipment, namely the REACH and RoHS directives. Philips Lumileds will not intentionally add the following restricted materials to the LUXEON Rebel: lead, mercury, cadmium, hexavalent chromium, polybrominated biphenyls (PBB) or polybrominated diphenyl ethers (PBDE).

Luminous Flux Characteristics

Luminous Flux Characteristics for LUXEON Rebel, Thermal Pad Temperature=25°C

Table 1.

Performance at Test Current				Typical Performance at Indicated Current	
Color	Part Number	Minimum Luminous Flux (lm) $\Phi_v^{[1]}$	Test Current (mA)	Typical Luminous Flux (lm) $\Phi_v^{[2]}$	Drive Current (mA)
Cool White	LXML-PWCI-0090	90	350	160	700
	LXML-PWCI-0100	100	350	180	700
	LXML-PWCI-0110	110	350	200	700
	LXML-PWCI-0120	120	350	220	700
Neutral-White	LXML-PWNI-0090	90	350	160	700
	LXML-PWNI-0100	100	350	180	700
	LXML-PWNI-0110	110	350	200	700
	LXML-PWNI-0120	120	350	220	700

Notes for Table 1:

1. Minimum luminous flux performance guaranteed within published operating conditions. Philips Lumileds maintains a tolerance of $\pm 6.5\%$ on flux measurements.
2. Typical luminous flux performance when device is operated within published operating conditions.

Flux Performance, Binning, and Supportability

LEDs are produced with semiconductor technology that is subject to process variation, yielding a range of flux performance that is approximately Gaussian in nature. In order to provide customers with fine granularity within the overall flux distribution, Philips Lumileds separates LEDs into fixed, easy to design with, minimum luminous flux bins. To verify supportability of parts chosen for your application design, please consult your Philips Lumileds representative.

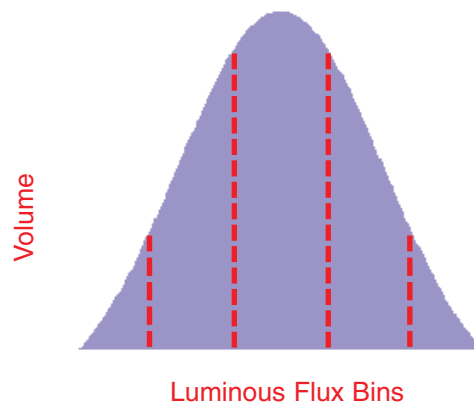

Optical Characteristics

Lambertian LUXEON Rebel at Test Current ^[1] Thermal Pad Temperature = 25°C

Table 2.

Color ^{[6],[7]}	Color Temperature ^{[2],[3]} CCT			Typical Total Included Angle ^[5] (degrees) $\theta_{0.90V}$ ^[4]	Typical Viewing Angle ^[6] (degrees) 2 θ 1/2
	Min.	Typ.	Max.		
Cool-White	4500K	6500K	10,000K	160	120
Neutral-White	3500K	4100K	4500K	160	120

Notes for Table 2:

1. Test current is 350 mA for all LXML-PWxI-0xxx products.
2. CCT $\pm 5\%$ tester tolerance.
3. Typical CRI (Color Rendering Index) for cool-white and neutral-white is 70.
4. Total angle at which 90% of total luminous flux is captured.
5. Viewing angle is the off axis angle from lamp centerline where the luminous intensity is $\frac{1}{2}$ of the peak value.
6. All white products are built with Indium Gallium Nitride (InGaN).
7. Cool-white and neutral-white power light sources represented here are IEC825 class 2 for eye safety.

Electrical Characteristics

Electrical Characteristics at 350 mA for LUXEON Rebel, Part Numbers LXML-PWxI-0xxx, Thermal Pad Temperature = 25°C

Table 3.

Color	Forward Voltage V_f [1]			Typical Temperature Coefficient of Forward Voltage [2] (mV/°C) $\Delta V_f / \Delta T_j$	Typical Thermal Resistance Junction to Thermal Pad (°C/W) $R\theta_{j-c}$
	Min.	Typ.	Max.		
Cool-White	2.55	3.00	3.99	-2.0 to -4.0	10
Neutral-White	2.55	3.00	3.99	-2.0 to -4.0	10

Notes for Table 3:

1. Philips Lumileds maintains a tolerance of $\pm 0.06V$ on forward voltage measurements.
2. Measured between $25^\circ C = T_j = 110^\circ C$ at $I_f = 350$ mA.

Typical Electrical Characteristics at 700 mA for LUXEON Rebel, Part Numbers LXML-PWxI-0xxx, Thermal Pad Temperature = 25°C [2]

Table 4.

Color	Typical Forward Voltage V_f [1] (V)
Cool-White	3.20
Neutral-White	3.20

Notes for Table 4:

1. Philips Lumileds maintains a tolerance of $\pm 0.06V$ on forward voltage measurements.
2. Measured between $25^\circ C = T_j = 110^\circ C$ at $I_f = 700$ mA.

Absolute Maximum Ratings

Table 5.

Parameter	Cool-White/Neutral-White
DC Forward Current (mA)	1000
Peak Pulsed Forward Current (mA)	1000
Average Forward Current (mA)	1000
ESD Sensitivity	< 8000V Human Body Model (HBM) Class 2 JESD22-A114-B < 400V Machine Model (MM) Class 2 JESD22-A115-B
LED Junction Temperature ^[1]	150°C
Operating Case Temperature at 350 mA	-40°C - 135°C
Storage Temperature	-40°C - 135°C
Soldering Temperature	JEDEC 020c 260°C
Allowable Reflow Cycles	3
Autoclave Conditions	121°C at 2 ATM 100% Relative Humidity for 96 Hours Maximum
Reverse Voltage (Vr)	See Note 2

Notes for Table 5:

1. Proper current derating must be observed to maintain junction temperature below the maximum.
2. LUXEON Rebel LEDs are not designed to be driven in reverse bias.

JEDEC Moisture Sensitivity

Table 6.

Level	Soak Requirements			
	Floor Life		Standard	
	Time	Conditions	Time	Conditions
1	unlimited	≤ 30°C / 85% RH	168h + 5 / -0	85°C / 85% RH

Reflow Soldering Characteristics

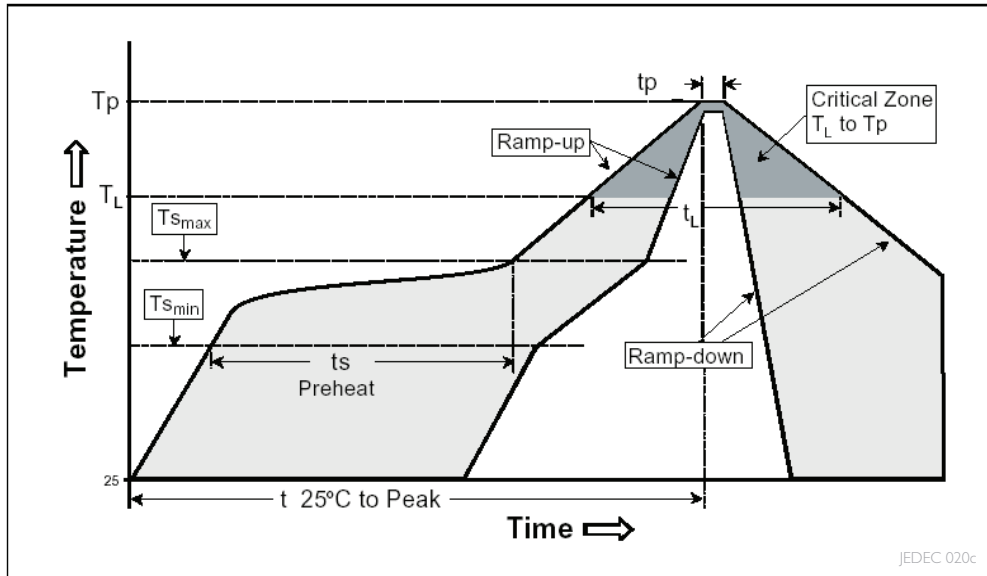

Table 7.

Profile Feature	Lead Free Assembly
Average Ramp-Up Rate ($T_{s_{max}}$ to T_p)	3°C / second max
Preheat Temperature Min ($T_{s_{min}}$)	150°C
Preheat Temperature Max ($T_{s_{max}}$)	200°C
Preheat Time ($t_{s_{min}}$ to $t_{s_{max}}$)	60 - 180 seconds
Temperature (T_l)	217°C
Time Maintained Above Temperature T_l (t_l)	60 - 150 seconds
Peak / Classification Temperature (T_p)	260°C
Time Within 5°C of Actual Peak Temperature (t_p)	20 - 40 seconds
Ramp - Down Rate	6°C / second max
Time 25°C to Peak Temperature	8 minutes max

Notes for Table 7:

- All temperatures refer to the application Printed Circuit Board (PCB), measured on the surface adjacent to the package body.

Mechanical Dimensions

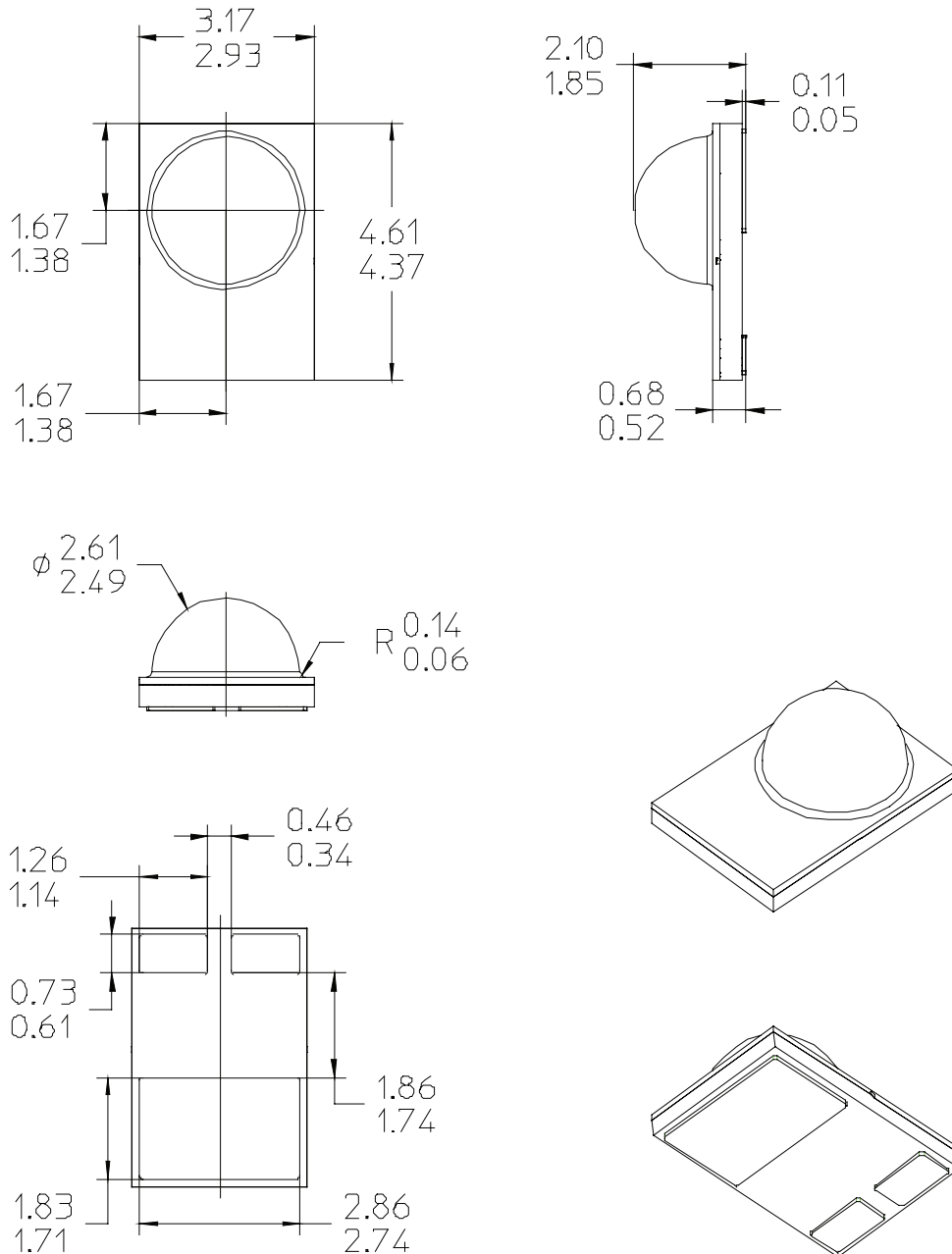
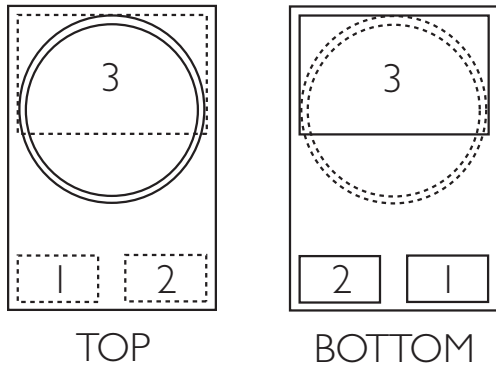

Figure I. Package outline drawing.

Notes for Figure I:

- Do not handle the device by the lens—care must be taken to avoid damage to the lens or the interior of the device that can be damaged by excessive force to the lens.
- Drawings not to scale.
- All dimensions are in millimeters.
- The Thermal Pad is electrically isolated from the Anode and Cathode contact pads.

Pad Configuration



PAD	FUNCTION
1	CATHODE
2	ANODE
3	THERMAL

Figure 2. Pad configuration.

Note for Figure 2:

- The Thermal Pad is electrically isolated from the Anode and Cathode contact pads.

Solder Pad Design

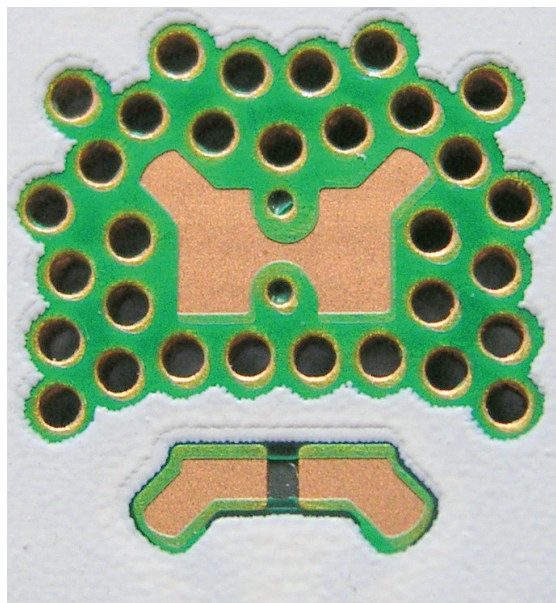

Figure 3. Solder pad layout.

Note for Figure 3:

- The photograph below shows the recommended LUXEON Rebel layout on Printed Circuit Board (PCB). This design easily achieves a thermal resistance of 7K/W.
- Application Brief AB32 provides extensive details for this layout. In addition, the .dwg files are available at www.philipslumileds.com and www.philipslumileds.cn.com.

Wavelength Characteristics

Cool-White at Test Current
Thermal Pad Temperature = 25°C

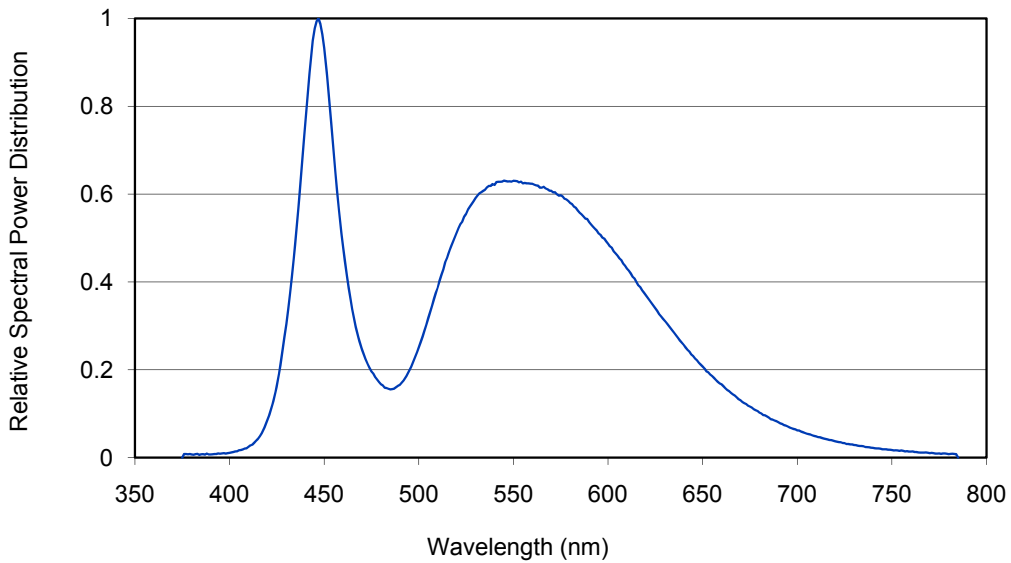

Figure 4a. Cool-white color spectrum of typical CCT part, integrated measurement

Neutral-White at Test Current
Thermal Pad Temperature = 25°C

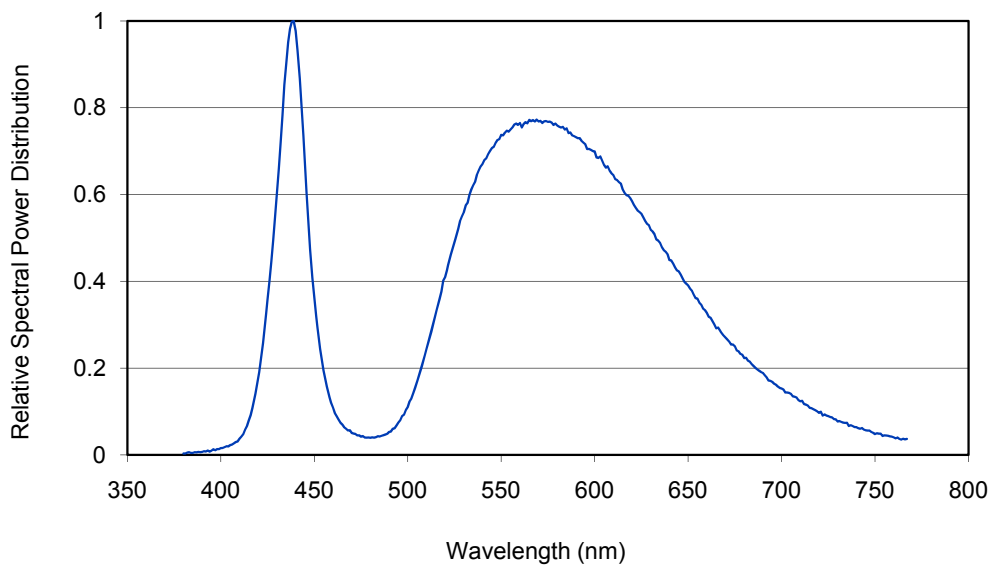

Figure 4b. Neutral-white color spectrum of typical CCT part, integrated measurement.

Typical Light Output Characteristics over Temperature

Cool-White and Neutral-White at Test Current

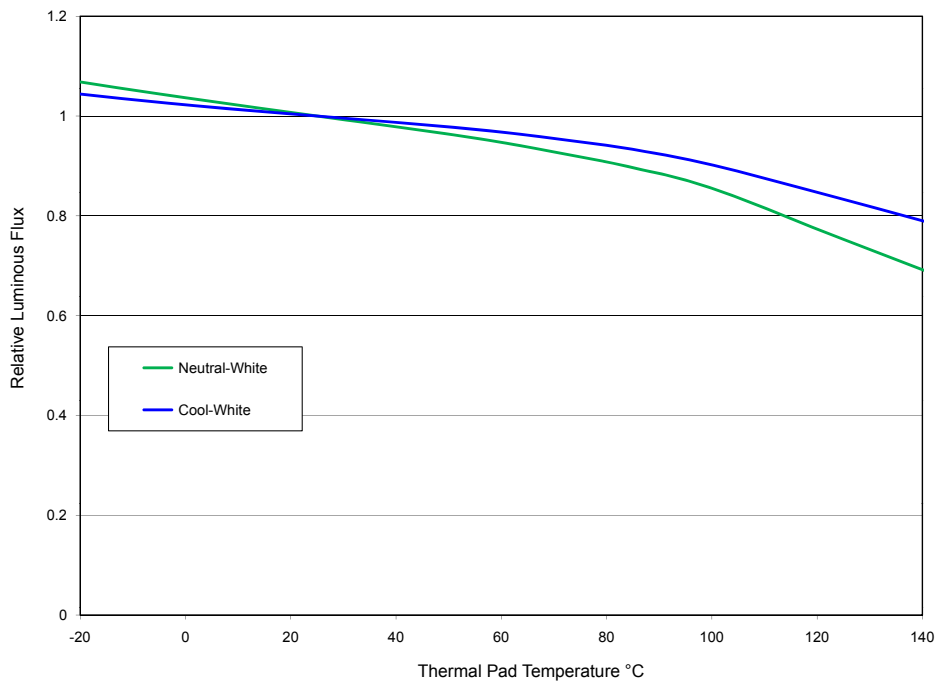

Figure 5. Relative luminous flux vs. thermal pad temperature.

Typical Forward Current Characteristics

Cool-White and Neutral-White
Thermal Pad Temperature = 25°C

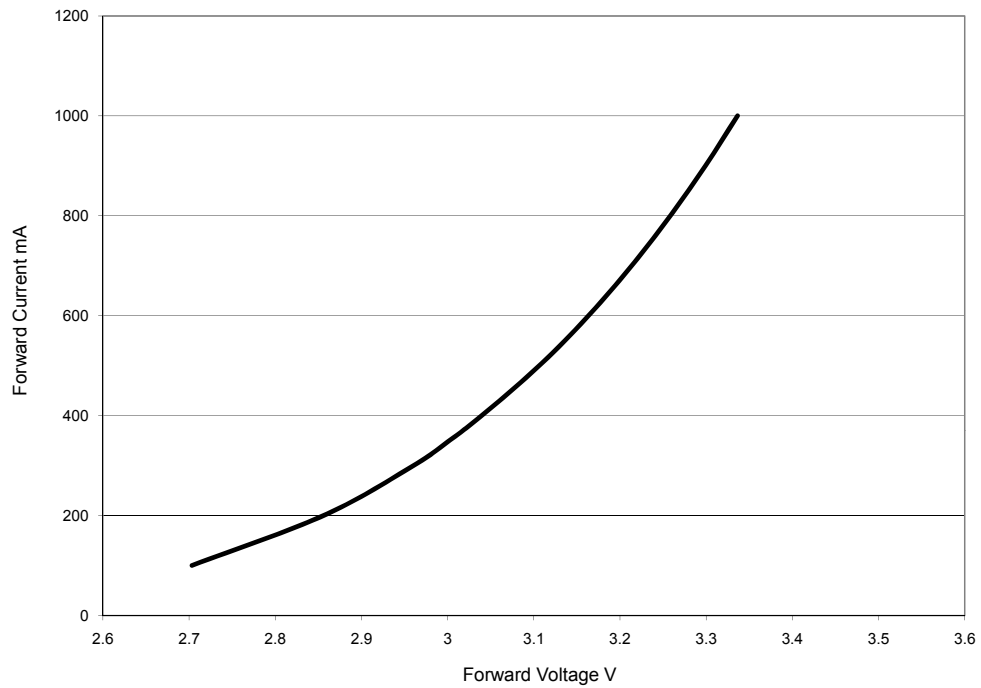

Figure 6. Forward current vs. forward voltage.

Typical Relative Luminous Flux

Typical Relative Luminous Flux vs. Forward Current for Cool-White and Neutral-White Thermal Pad Temperature = 25°C

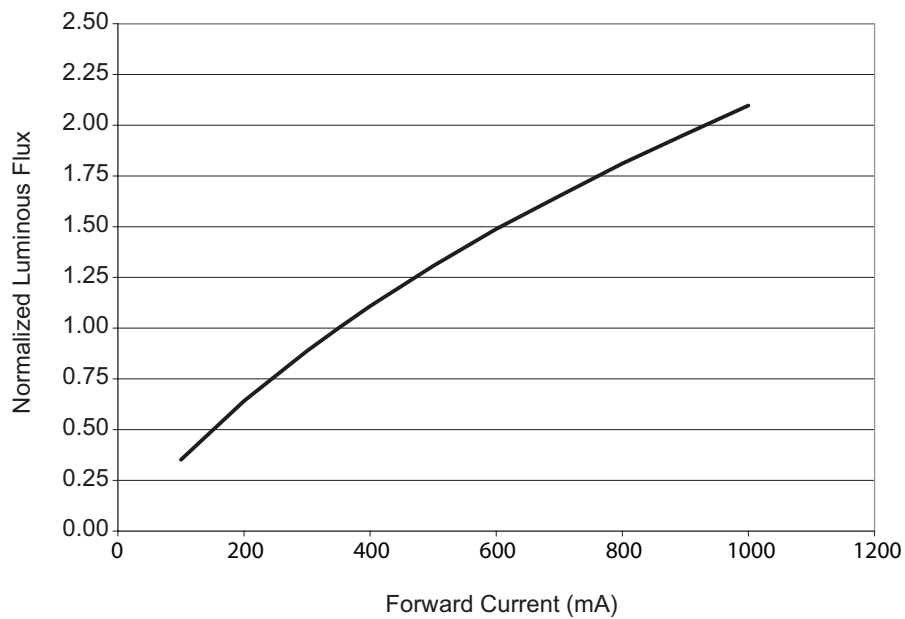

Figure 7. Relative luminous flux or radiometric power vs. forward current for cool-white and neutral-white, Thermal Pad = 25°C maintained.

Current Derating Curves

Current Derating Curve for 350 mA Drive Current Cool-White and Neutral-White

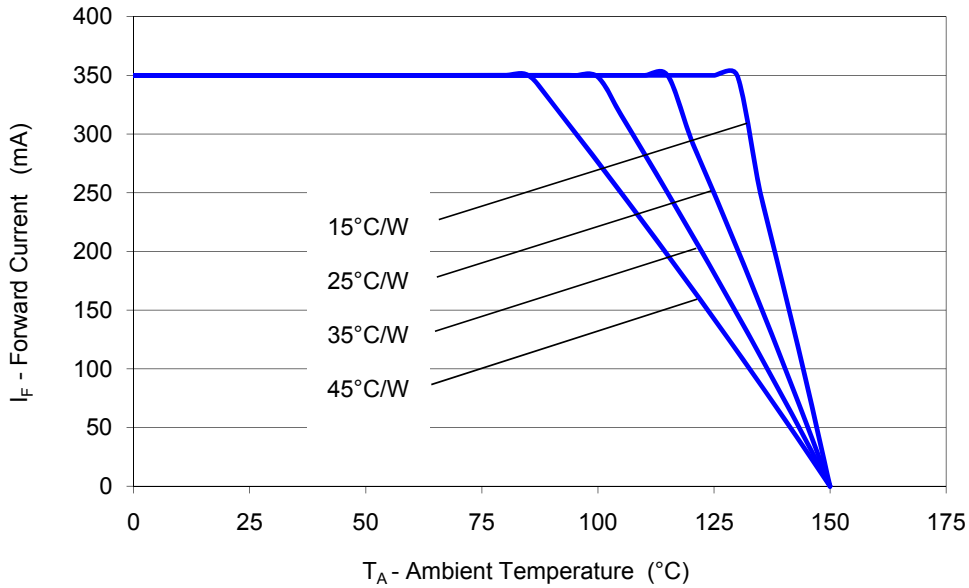

Figure 8. Maximum forward current vs. ambient temperature, based on $T_{JMAX} = 150^\circ\text{C}$.

Current Derating Curve for 700 mA Drive Current Cool-White and Neutral-White

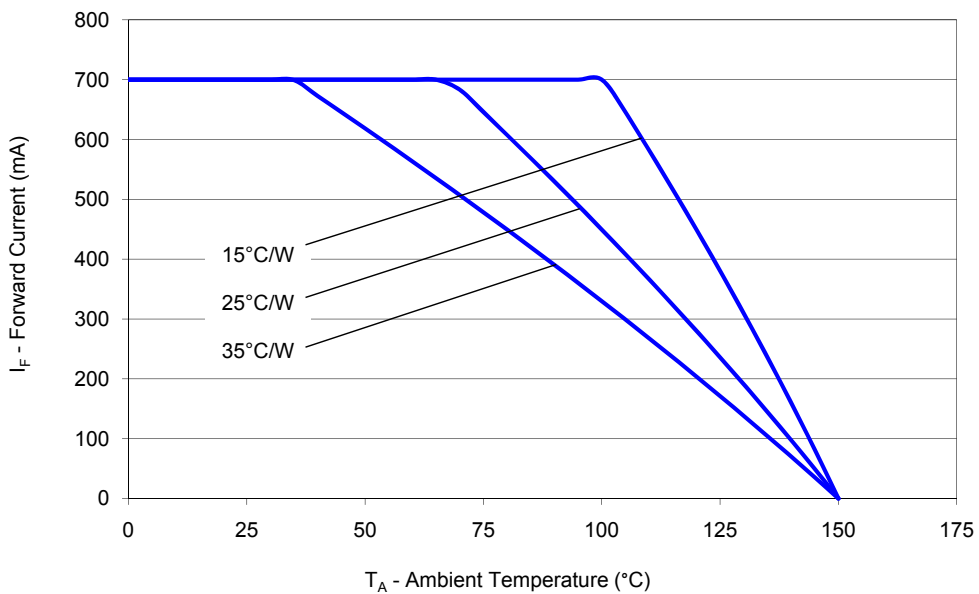

Figure 9. Maximum forward current vs. ambient temperature, based on $T_{JMAX} = 150^\circ\text{C}$.

I. Current derating curves represent constant current operation condition.

Current Derating Curve for 1000 mA Drive Current Cool-White and Neutral-White

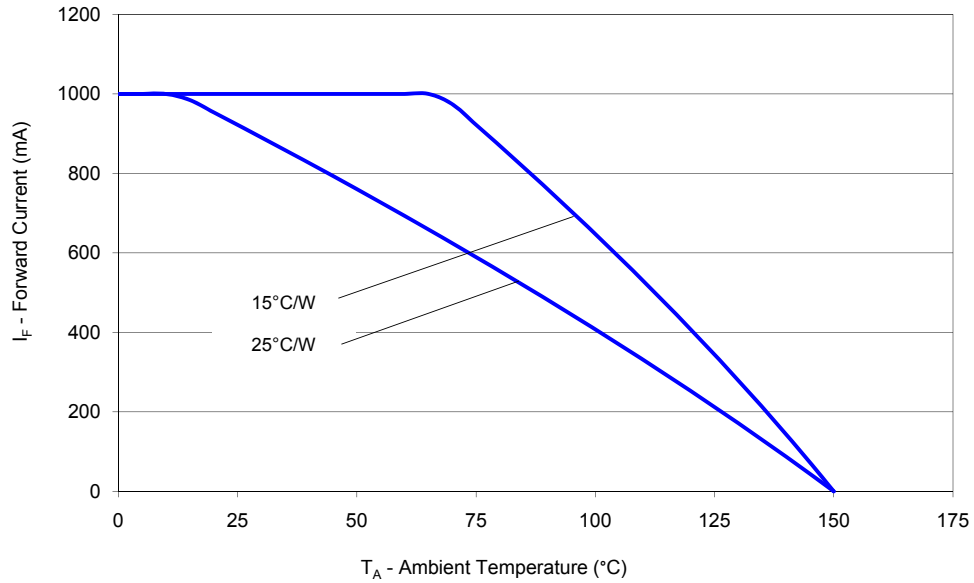

Figure 10. Maximum forward current vs. ambient temperature, based on $T_{JMAX} = 150^{\circ}C$.

Typical Radiation Patterns

Typical Spatial Radiation Pattern for Cool-White and Neutral-White Lambertian

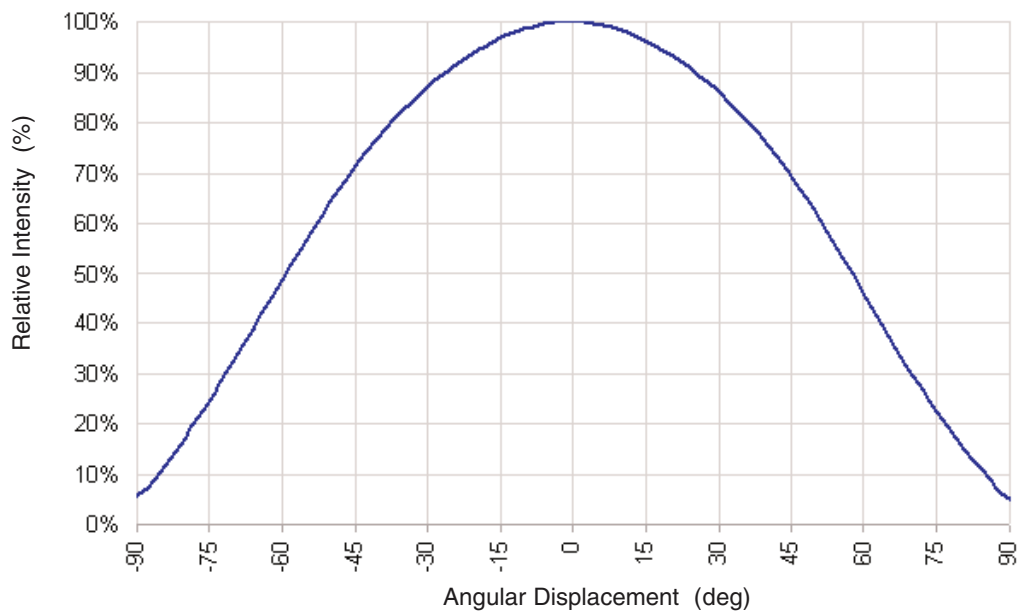

Figure 11a. Typical representative spatial radiation pattern for cool-white and neutral-white lambertian.

Typical Polar Radiation Pattern for White Lambertian

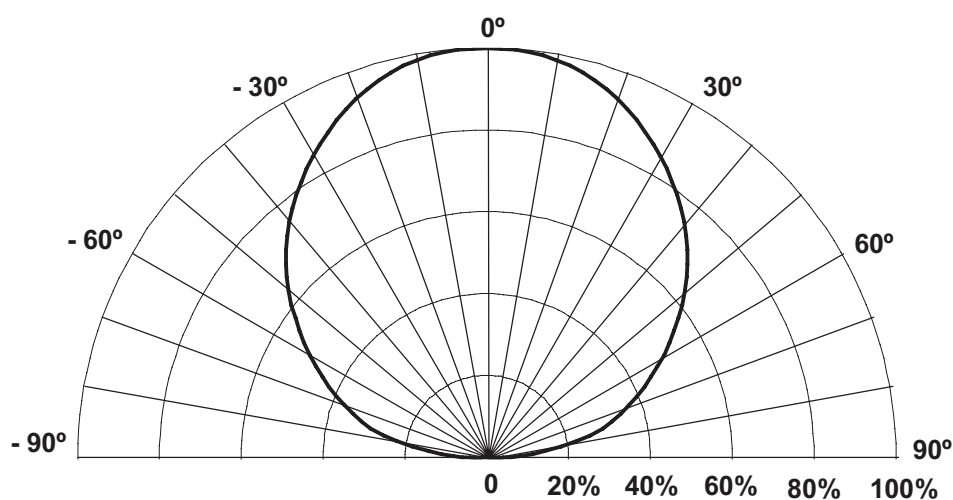

Figure 11b. Typical polar radiation pattern for cool-white and neutral-white lambertian.

Emitter Pocket Tape Packaging

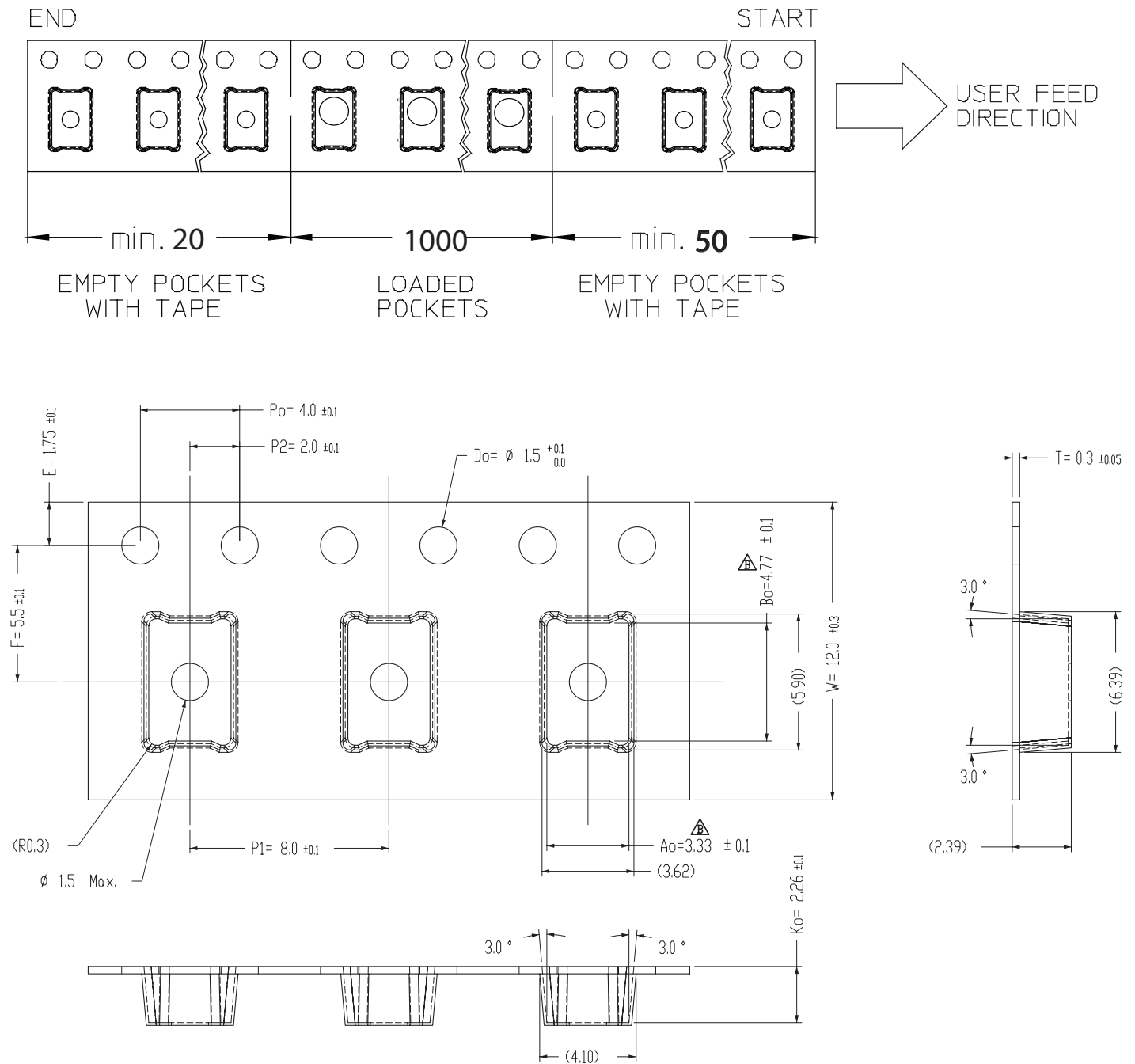

Figure 13. Emitter pocket tape packaging

Emitter Reel Packaging

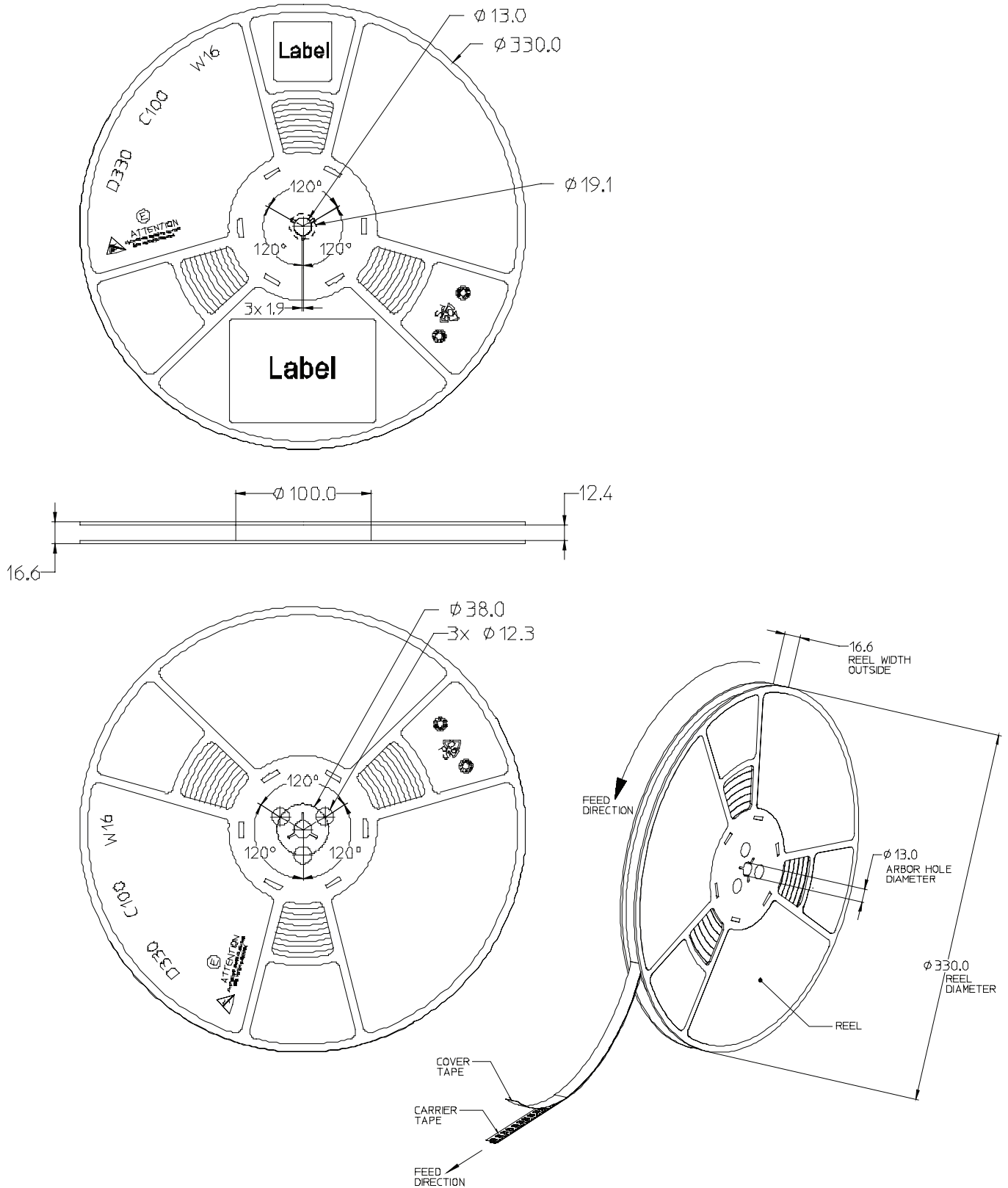

Figure 14. Emitter reel packaging

Product Binning and Labeling

Purpose of Product Binning

In the manufacturing of semiconductor products, there is a variation of performance around the average values given in the technical data sheets. For this reason, Philips Lumileds bins the LED components for luminous flux, color and forward voltage (V_f).

Decoding Product Bin Labeling

LUXEON Rebel emitters are labeled using a three or four digit alphanumeric code (CAT code) depicting the bin values for emitters packaged on a single reel. All emitters packaged within a reel are of the same 3-variable bin combination. Using these codes, it is possible to determine optimum mixing and matching of products for consistency in a given application.

Reels of Cool-White and Neutral-White emitters are labeled with a four digit alphanumeric CAT code following the format below.

ABCD

A = Flux bin (J, K, L, M etc.)

B and C = Color bin (W0, U0, V0 etc.)

D = V_f bin (D, E, F, G etc.)

Luminous Flux Bins

Table 8 lists the standard photometric luminous flux bins for LUXEON Rebel emitters (tested and binned at 350 mA).

Although several bins are outlined, product availability in a particular bin varies by production run and by product performance. Not all bins are available in all colors.

Table 8.

Flux Bins

Bin Code	Minimum Photometric Flux (lm)	Maximum Photometric Flux (lm)
H	50	60
J	60	70
K	70	80
L	80	90
M	90	100
N	100	110
X	110	120
P	120	130
Y	130	140
Q	140	150
R	150	160
S	180	200

Cool-White Bin Structure

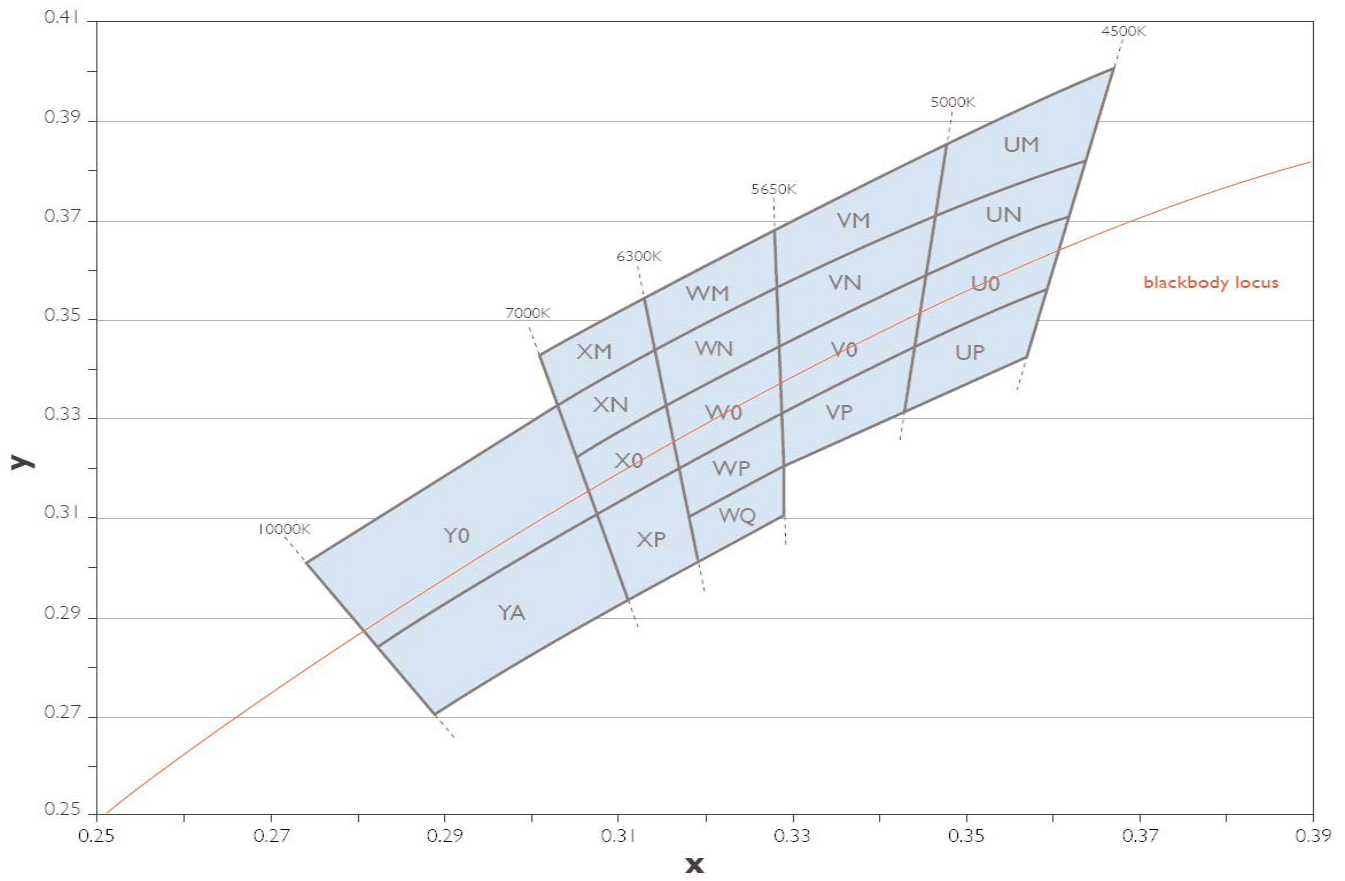

Figure 15. Cool-White bin structure.

Cool-White LUXEON Rebel emitters are tested and binned by x,y coordinates. 19 Color Bins, CCT Range 4,500K to 10,000K.

Table 9.

Cool-White Bin Coordinates							
Bin Code	X	Y	Typical CCT (K)	Bin Code	X	Y	Typical CCT (K)
YO	0.274238	0.300667	8000	WQ	0.318606	0.310201	6000
	0.303051	0.332708			0.329393	0.320211	
	0.307553	0.310778			0.329544	0.310495	
	0.282968	0.283772			0.319597	0.301303	
YA	0.282968	0.283772	8000	VM	0.328636	0.368952	5300
	0.307553	0.310778			0.348147	0.385629	
	0.311163	0.293192			0.346904	0.371742	
	0.289922	0.270316			0.328823	0.356917	
XM	0.301093	0.342244	6700	VN	0.328823	0.356917	5300
	0.313617	0.354992			0.346904	0.371742	
	0.314792	0.344438			0.345781	0.359190	
	0.303051	0.332708			0.329006	0.345092	
XN	0.303051	0.332708	6700	VO	0.329006	0.345092	5300
	0.314792	0.344438			0.345781	0.359190	
	0.316042	0.333222			0.344443	0.344232	
	0.305170	0.322386			0.329220	0.331331	
XO	0.305170	0.322386	6700	VP	0.329220	0.331331	5300
	0.316042	0.333222			0.344443	0.344232	
	0.317466	0.320438			0.343352	0.332034	
	0.307553	0.310778			0.329393	0.320211	
XP	0.307553	0.310778	6700	UM	0.348147	0.385629	4750
	0.317466	0.320438			0.367294	0.400290	
	0.319597	0.301303			0.364212	0.382878	
	0.311163	0.293192			0.346904	0.371742	
WM	0.313617	0.354992	6000	UN	0.346904	0.371742	4750
	0.328636	0.368952			0.364212	0.382878	
	0.328823	0.356917			0.362219	0.371616	
	0.314792	0.344438			0.345781	0.359190	
WN	0.314792	0.344438	6000	UO	0.345781	0.359190	4750
	0.328823	0.356917			0.362219	0.371616	
	0.329006	0.345092			0.359401	0.355699	
	0.316042	0.333222			0.344443	0.344232	
WO	0.316042	0.333222	6000	UP	0.344443	0.344232	4750
	0.329006	0.345092			0.359401	0.355699	
	0.329220	0.331331			0.357079	0.342581	
	0.317466	0.320438			0.343352	0.332034	
WP	0.317466	0.320438	6000				
	0.329220	0.331331					
	0.329393	0.320211					
	0.318606	0.310201					

Note for Table 9:

- Philips Lumileds maintains a tester tolerance of ± 0.005 on x,y color coordinates.

Neutral-White Bin Structure

Neutral-White LUXEON Rebel emitters are tested and binned by x,y coordinates. 12 Color Bins, CCT Range 3,500K to 4,500K.

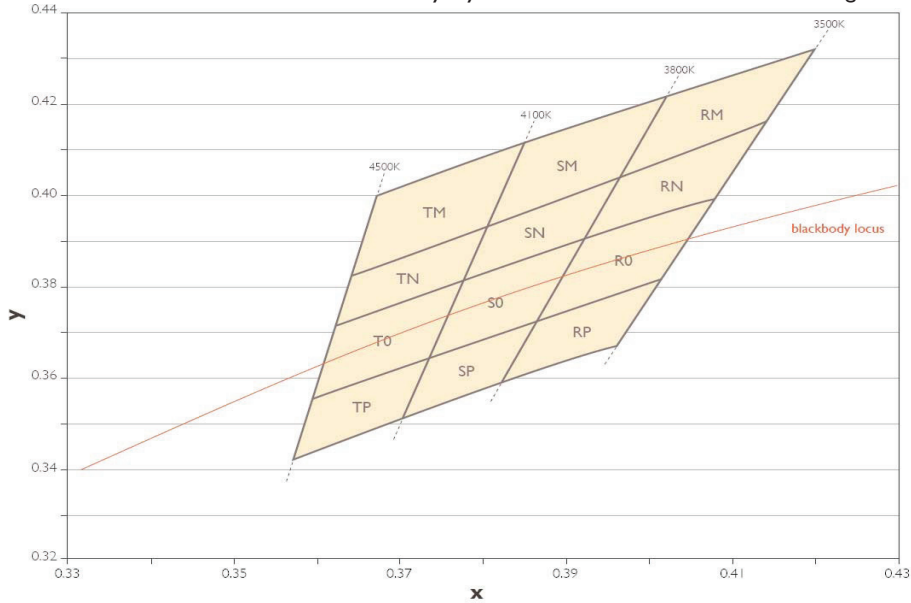

Figure 16. Neutral-White bin structure.

Table 10.

Neutral-White Bin Coordinates

Bin Code	X	Y	Typical CCT (K)	Bin Code	X	Y	Typical CCT (K)
TM	0.367294	0.400290	4300	SO	0.378264	0.382458	3950
	0.385953	0.412995			0.392368	0.390932	
	0.381106	0.393747			0.387071	0.373899	
	0.364212	0.382878			0.374075	0.365822	
TN	0.364212	0.382878	4300	SP	0.374075	0.365822	3950
	0.381106	0.393747			0.387071	0.373899	
	0.378264	0.382458			0.382598	0.359515	
	0.362219	0.371616			0.370582	0.351953	
T0	0.362219	0.371616	4300	RM	0.402270	0.422776	3650
	0.378264	0.382458			0.420940	0.432618	
	0.374075	0.365822			0.414776	0.416097	
	0.359401	0.355699			0.396279	0.403508	
TP	0.359401	0.355699	4300	RN	0.396279	0.403508	3650
	0.374075	0.365822			0.414776	0.416097	
	0.370582	0.351953			0.408593	0.399525	
	0.357079	0.342581			0.392368	0.390932	
SM	0.385953	0.412995	3950	RO	0.392368	0.390932	3650
	0.402270	0.422776			0.408593	0.399525	
	0.396279	0.403508			0.402113	0.382156	
	0.381106	0.393747			0.387071	0.373899	
SN	0.381106	0.393747	3950	RP	0.387071	0.373899	3650
	0.396279	0.403508			0.402113	0.382156	
	0.392368	0.390932			0.396564	0.367284	
	0.378264	0.382458			0.382598	0.359515	

Note for Table 10:

- Philips Lumileds maintains a tester tolerance of ± 0.005 on x,y color coordinates.

Forward Voltage Bins

Table II lists minimum and maximum V_f bin values per emitter. Although several bins are outlined, product availability in a particular bin varies by production run and by product performance.

Table II.

V_f Bins

Bin Code	Minimum Forward Voltage (V)	Maximum Forward Voltage (V)
B	2.55	2.79
C	2.79	3.03
D	3.03	3.27
E	3.27	3.51
F	3.51	3.75
G	3.75	3.99

Who We Are

Philips Lumileds focuses on one goal: Creating the world's highest performing LEDs. The company pioneered the use of solid-state lighting in breakthrough products such as the first LED backlit TV, the first LED flash in camera phones, and the first LED daytime running lights for cars. Today we offer the most comprehensive portfolio of high quality LEDs and uncompromising service.

Philips Lumileds brings LED's qualities of energy efficiency, digital control and long life to spotlights, downlights, high bay and low bay lighting, indoor area lighting, architectural and specialty lighting as well as retrofit lamps. Our products are engineered for optimal light quality and unprecedented efficacy at the lowest overall cost. By offering LEDs in chip, packaged and module form, we deliver supply chain flexibility to the inventors of next generation illumination.

Philips Lumileds understands that solid state lighting is not just about energy efficiency. It is about elegant design. Reinventing form. Engineering new materials. Pioneering markets and simplifying the supply chain. It's about a shared vision. Learn more about our comprehensive portfolio of LEDs at www.philipslumileds.com.

©2014 Philips Lumileds Lighting Company. All rights reserved.
Product specifications are subject to change without notice.
LUXEON is a registered trademark of the Philips Lumileds
Lighting Company in the United States and other countries.

PHILIPS
LUMILEDS

www.philipslumileds.com
www.philipslumileds.cn.com

X-ON Electronics

Largest Supplier of Electrical and Electronic Components

Click to view similar products for [opulent manufacturer](#):

Other Similar products are found below :

[STAR-LUXEON-ZES-24080-3](#) [CCK-XHP50-CK01](#) [REBEL STAR](#) [LUXEONZ-RGBA](#) [XPEPHR-L1-0000-00901-SB01](#) [XHP70A-0L-04-0D0BN450E](#) [LST1-01F04-5770-01](#) [LST1-01F04-5070-01](#) [LST1-01F04-3070-01](#) [XPERDO-L1-0000-00A01-SB01](#) [LST1-01F05-3070-01](#) [LST1-01F05-4070-01](#) [LST1-01G01-GRN1-00](#) [LVS1-04C05-2790-00](#) [LSR1-04C32-5070-00](#) [LSR1-12C32-5070-00](#) [LSR1-12C32-5770-00](#) [LVS1-04C05-4070-00](#) [LSR1-04C32-4070-00](#) [SSB1-72F16-3090-00](#) [SSB1-72F16-4090-00](#) [XHP35A-0R-08-0D0BE450E](#) [XHP70A-0L-02-0D0BN450E](#) [XHP50A-0L-02-0D0BJ450E](#) [XHP70A-0L-03-0D0BN450E](#) [LST1-01F05-5070-01](#) [LUXEONZ-4UP-MCPCB](#) [XHP50A-0S-04-0D0BJ440E](#) [XPLAWT-H0-0000-000BV20E5-SB01](#) [LST1-01C48-5770-01](#) [LST1-01F07-3070-01](#) [XHP35A-0R-08-0D0BE240E](#) [XPLAWT-00-0000-0000V60E1-SB01](#) [XPGDWT-B1-0000-00L5E-SB01](#) [LST1-01F07-5770-01](#) [LST1-01F05-5770-01](#) [LPS1-01C24-2790-00](#) [STAR-LG3535HP3W-35](#) [XHP50A-00-0000-0D0BJ440E-SB01](#) [LSS1-04C22-4070-00](#) [LST1-01C48-4080-01](#) [XHP35A-0R-04-0D0UB427E](#) [LST1-01C48-3580-01](#) [DSB1-66G02-3018-90-01](#) [XHP35A-0R-12-0D0UB427E](#) [XHP70A-0S-04-0D0BN240E](#) [STAR-LUXEON-ZES-25770](#) [XHP70A-0S-04-0D0BN450E](#) [LST1-01G01-UV02-00](#) [MHDGWT-0000-000N0HK427G-SB01](#)