



CONTROL PRODUCTS

22mm Diameter Control Switches

- Metal and plastic bodied control Push-Buttons, E-stops & selector switches
- Rated 600V, 10A max AC
- Operating frequency 3,600 per hour
- Panels mount 1-6mm thick
- Positive opening operation
- Conform to IEC 947-5-1 & EN 60947-5-1
- Terminal marking to EN 50013
- Other button options available to order
-    approved

SPECIFICATION		
Rated voltage		600V
Rated AC current	24V	10A
	240V	6A
	400V	4A
Rated DC current	24V	2.8A
	125V	0.55A
	250V	0.27A
Short circuit protection	gG fuse	10A
Impulse withstand		6kV
Internal resistance		<25mΩ
Wire acceptance		0.75-2.5mm ²
Rated temperature	Operating	-25° to +70°
	Storage	-40° to +80°
Body / escutcheon	Metal	Chromium plated
	Plastic	Fibreglass reinforced thermo-plastic
Electrical Protection	Metal	Class I
	Plastic	Class II
Ingress Protection		IP65
Life		1x10 ⁶ operation

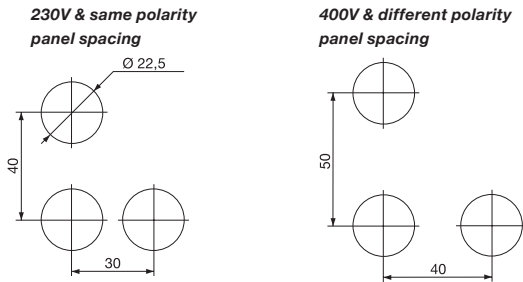
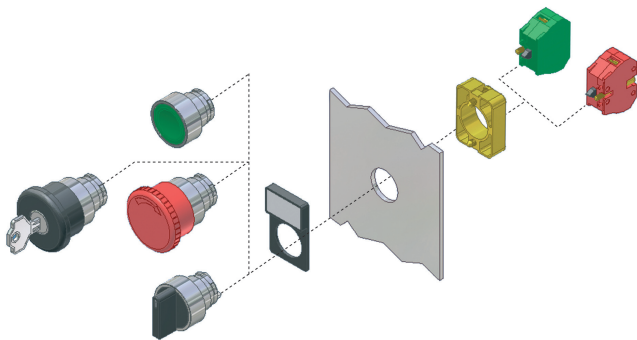

Flush Push Buttons

METAL BODIED	PLASTIC BODIED	COLOUR
CCTTR30BK	CCTPR30BK	Black
CCTTR30RD	CCTPR30RD	Red
CCTTR30GW	CCTPR30GW	Green
CCTTR30YW	CCTPR30YW	Yellow
CCTTR30BL	CCTPR30BL	Blue
CCTTR30WH	CCTPR30WH	White

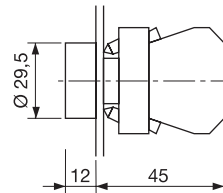

On/Off Push Buttons

METAL BODIED	PLASTIC BODIED	COLOUR
CCTTR00RD	CCTPR00RD	Red -0
CCTTR01GN	CCTPR01GN	Green -1

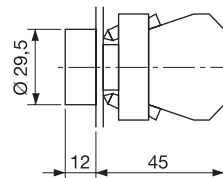

Arrow Push Buttons

METAL BODIED	PLASTIC BODIED	STYLE
CCTTRAHBK	-	Horizontal
CCTTRAVBK	-	Vertical

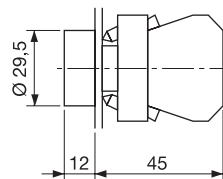

PCB
TERMINAL
BLOCKS

INTER-
CONNECTION

FUSES &
FUSE-
HOLDERS

LEDs &
INDICATORS

MINIATURE
SWITCHES

LIMIT &
SAFETY
SWITCHES

CONTROL
PRODUCTS

INTERFACE
MODULES &
SUPPORTS

RELAY
BASES

ENCLOSURES

BATTERIES

TRANS-
FORMERS



+44 (0)1638 716101
info@camdenboss.com
www.camdenboss.com

We operate a constant improvement policy,
our products are subject to change without notice.

CAMDENBOSS
ELECTRONICS & ENCLOSURES

CONTROL PRODUCTS

Start/Stop Push Buttons

METAL BODIED	PLASTIC BODIED	STYLE
CCTTRSTWH	-	White Start
CCTTRSPBK	-	Black Stop
CCTTRONWH	-	White On
CCTTROFBK	-	Black Off

Black Button - Extended Height

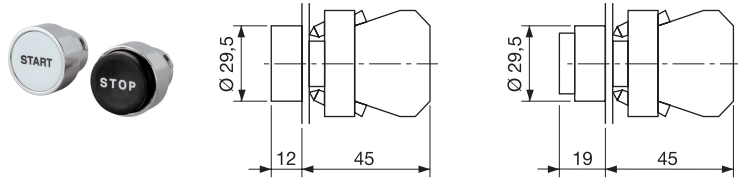

40mm E-stop Key Release

METAL BODIED	PLASTIC BODIED	COLOUR
CCTTM41LB	CCTPM41LB	Black
CCTTM41LR	CCTPM41LR	Red

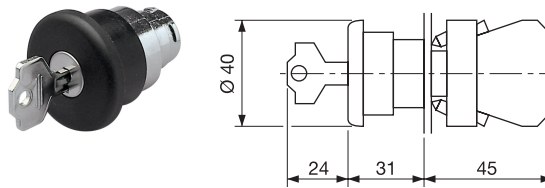

40mm E-stop Twist Release

METAL BODIED	PLASTIC BODIED	COLOUR
CCTTM40LB	CCTPM40LB	Black
CCTTM40LR	CCTPM40LR	Red

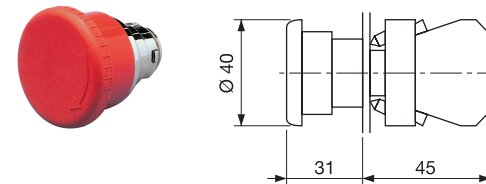

60mm E-stop Twist Release

METAL BODIED	PLASTIC BODIED	COLOUR
CCTTM60LB	CCTPM60LB	Black
CCTTM60LR	CCTPM60LR	Red

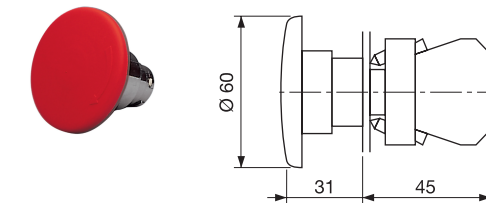

Selector Switch

- Black short lever, 2 and 3 position selector switch
- Maintain & spring return options

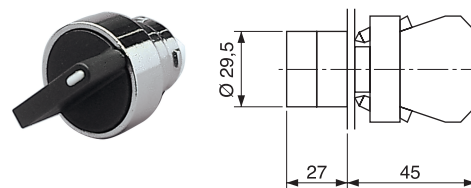

METAL BODIED	PLASTIC BODIED	POSITIONS	STYLE
CCTTSS211	CCTPSS211	2	Maintained left & right
CCTTSS210	CCTPSS210	2	Return left
CCTTSS311	CCTPSS311	3	Maintained left, centre & right
CCTTSS300	CCTPSS300	3	Return to centre from left & right
CCTTSS301	CCTPSS301	3	Return to centre from left, maintained right
CCTTSS310	CCTPSS310	3	Return to centre from right, maintained left

CONTROL PRODUCTS

Contact Block

- NO and NC contact blocks
- Screw fixed to mounting plate
- Can be stacked side by side/piggybacked

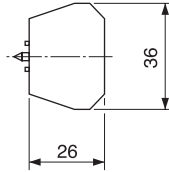

TYPE NO.	DESCRIPTION
CCTTC1R	Red NC
CCTTC0G	Green NO

Mounting Plate

- Metal mounting plate for contact blocks
- Holds 1 or 2 NO or NC contact blocks

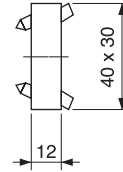

TYPE NO.	DESCRIPTION
CCTTP	Mounting plate

Contact Block with Mounting Plate

- Control blocks and mountings plates as above supplied as one assembly

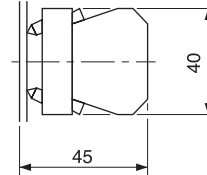
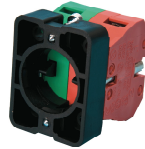

TYPE NO.	DESCRIPTION
CC10B	Green NO contact + metal base
CC01B	Red NC contact + metal base
CC10B/P	Green NO contact + plastic base
CC01B/P	Red NC contact + plastic base

Dust Cap

- Clear Silicon protection cap for push buttons
- Other colours to order



TYPE NO.	DESCRIPTION
CCTTRDCL	Clear dust cap

Keys for E-Stop Key Release

TYPE NO.	SLEEVE
CCTTKRD	Red
CCTTKBK	Black



Button Surrounds

- Yellow engraved black emergency stop
- Black name plate with recessed label area



TYPE NO.	DESCRIPTION
CCTTBES	60mm diameter e-stop
CCTTBNP	Name plate blank

PCB
TERMINAL
BLOCKS

INTER-
CONNECTION

FUSES &
FUSE-
HOLDERS

LEDs &
INDICATORS

MINIATURE
SWITCHES

LIMIT &
SAFETY
SWITCHES

CONTROL
PRODUCTS

INTERFACE
MODULES &
SUPPORTS

RELAY
BASES

ENCLOSURES

BATTERIES

TRANS-
FORMERS



CONTROL PRODUCTS

Control Stations

- IP65 ABS enclosures suitable for control switches and equipment
- Grey and Yellow lid colour options
- Standard boxes and holes moulded in for 22mm diameter control switches
- Diameter 21mm (PG13.5) knockouts moulded in enclosure
- Pre assembled control station and control switching available to order
- Larger size to order

SPECIFICATION

Material	ABS	
Protection class	IP65	
Rated temperature	Operating	-25° to +70°
	Storage	-40° to +80°
Standard colours	Box & lid	Grey RAL 7035
	lid	Yellow RAL 1103

Standard Boxes

TYPE NO.	LID COLOUR	LEGNTH	WIDTH	HEIGHT
CCS00GY00	Grey	70mm	70mm	51mm
CCS03GY00	Grey	70mm	70mm	74mm
CCS05GY00	Grey	105mm	70mm	51mm
CCS06GY00	Grey	105mm	70mm	74mm
CCS07GY00	Grey	140mm	70mm	51mm
CCS08GY00	Grey	140mm	70mm	74mm
CCS09GY00	Grey	185mm	70mm	51mm
CCS10GY00	Grey	185mm	70mm	74mm



Single Button

TYPE NO.	LID COLOUR	LEGNTH	WIDTH	HEIGHT
CCS00GY01	Grey	70mm	70mm	51mm
CCS00YW01	Yellow	70mm	70mm	51mm
CCS03GY01	Grey	70mm	70mm	74mm
CCS03YW01	Yellow	70mm	70mm	74mm



Two Button

TYPE NO.	LID COLOUR	LEGNTH	WIDTH	HEIGHT
CCS05GY02	Grey	105mm	70mm	51mm
CCS06GY02	Grey	105mm	70mm	51mm



Three Button

TYPE NO.	LID COLOUR	LEGNTH	WIDTH	HEIGHT
CCS07GY03	Grey	140mm	70mm	51mm
CCS08GY03	Grey	140mm	70mm	51mm



Four Button

TYPE NO.	LID COLOUR	LEGNTH	WIDTH	HEIGHT
CCS09GY04	Grey	185mm	70mm	51mm
CCS10GY04	Grey	185mm	70mm	51m



Five & Six Button

TYPE NO.	BUTTONS	LID COLOUR	LEGNTH	WIDTH	HEIGHT
CCS11GY05	5	Grey	225mm	70mm	74mm
CCS11GY06	6	Grey	225mm	70mm	74mm



CONTROL PRODUCTS

Mounting Plates

TYPE NO.	BUTTONS
CCSP01	1
CCSP02	2
CCSP03	3
CCSP04	4
CCSP05	5

for 6 button use 2x CCSP03

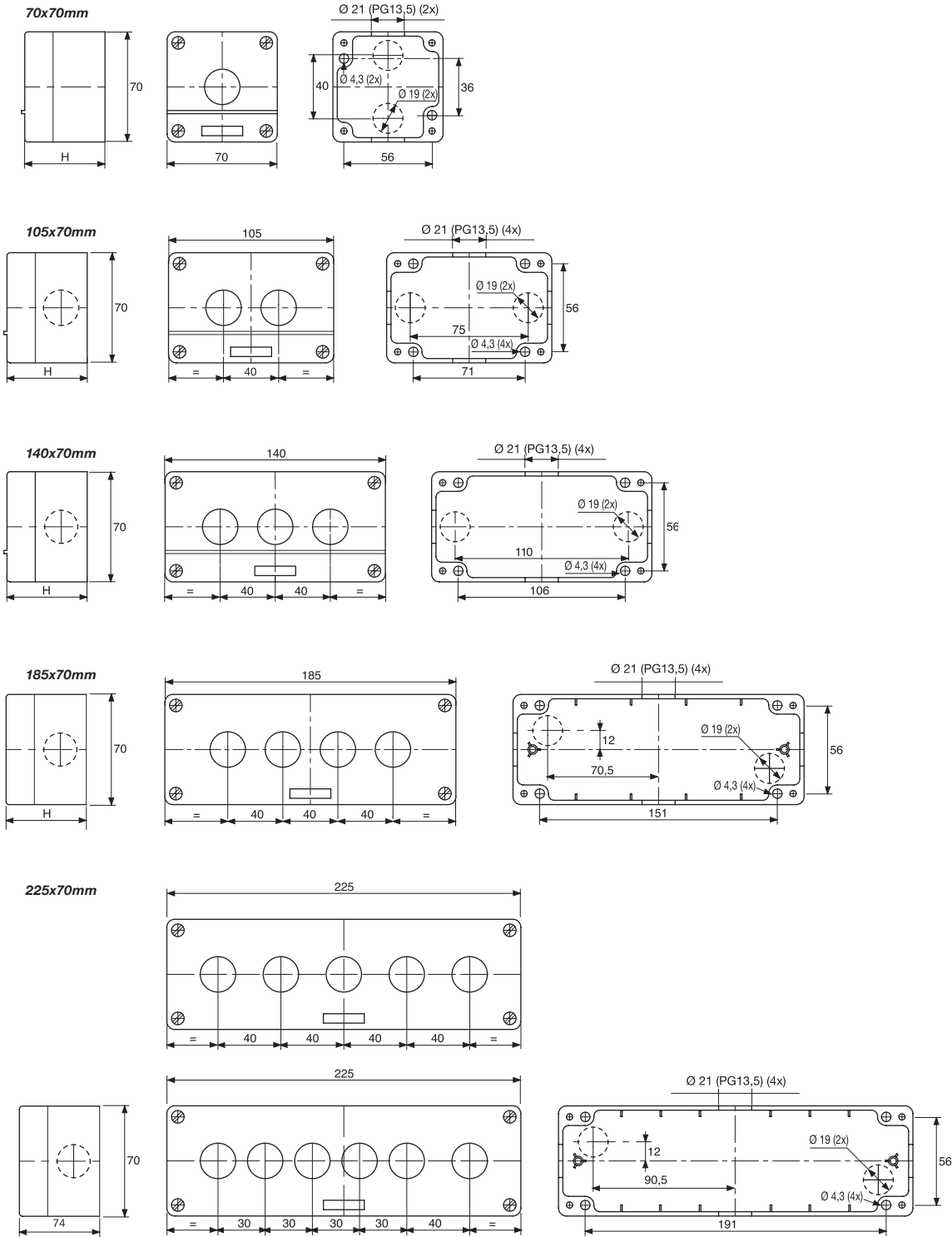

PCB
TERMINAL
BLOCKS

INTER-
CONNECTION

FUSES &
FUSE-
HOLDERS

LEDs &
INDICATORS

MINIATURE
SWITCHES

LIMIT &
SAFETY
SWITCHES

CONTROL
PRODUCTS

INTERFACE
MODULES &
SUPPORTS

RELAY
BASES

ENCLOSURES

BATTERIES

TRANS-
FORMERS



+44 (0)1638 716101
info@camdenboss.com
www.camdenboss.com

We operate a constant improvement policy,
our products are subject to change without notice.

CAMDENBOSS
ELECTRONICS & ENCLOSURES

CONTROL PRODUCTS

Heavy Duty Footswitch

- Industrial die-cast footswitch
- Heavy duty IP65 applications
- Snap action and slow action contact blocks
1 NO + 1 NC
- Rising saddle-washer terminal connections
- Single or double double-pole contact blocks
- Positive opening operation
- Silver contacts
- Anti Slip foot pedal
- Non-slip rubber feet
- Supplied with IP65 cable gland
- CE approved



PART NO.	DESCRIPTION
CFSHC1	Guarded 1 snap action contact block
CFSHC2	Guarded 1 slow action contact block
CFSHC1C1	Guarded 2 snap action contact blocks
CFSHC2C2	Guarded 2 slow action contact blocks
CFSHC1C2	Guarded 1 snap and 1 slow action contact blocks

SPECIFICATIONS

Contact Block Rated	10A		
Insulation voltage (U _i)	500VAC 600VDC		
Protection against short circuits	fuse 10A 500V type aM		
Alternate current: AC15 (50-60Hz)			
U _i (V)	250	400	500
I _e (A)	6	4	1
Direct current: DC13			
U _e (V)	24	125	250
I _e (A)	6	1.1	0.4
Connectors flexible wire sizes	min	1 x 0.5 mm ² (1 x AWG 20)	
	max	2 x 2.5mm ² (2 x AWG 14)	
Actuating force	single snap action	10N	
	single slow action	12N	
	double snap action	13N	
	double slow action	15N	
Ambient temperature	from -25°C to +80°C		
Weight guarded	1.4 kg		

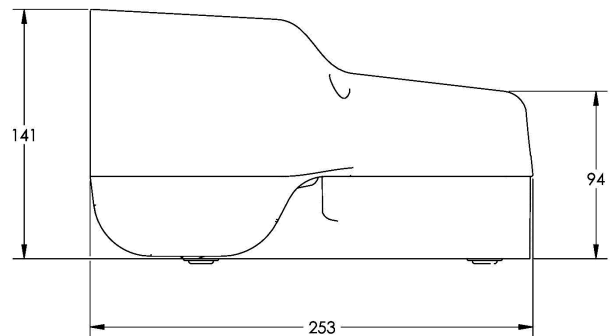
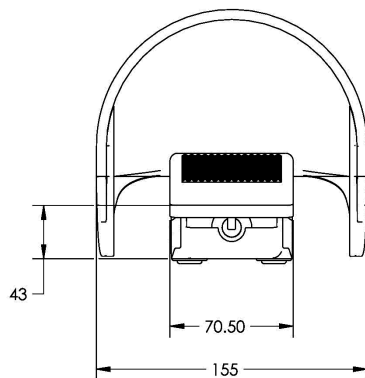
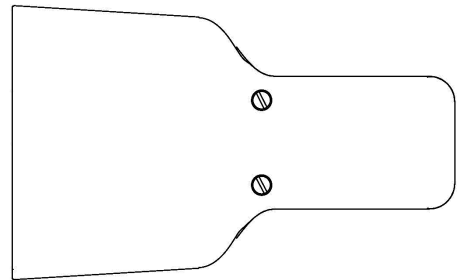

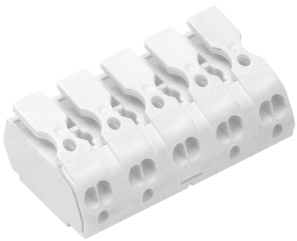
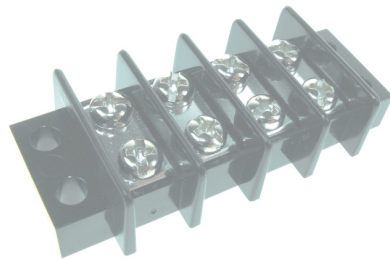
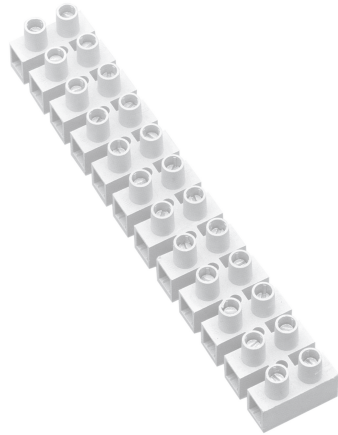

GET CONNECTED

For our range of Interconnection components including 12-way nylon and easy break terminal strips, high temperature resistant connection blocks, barrier strips and isolating strips and blocks see page 58-77.

PCB
TERMINAL
BLOCKS

INTER-
CONNECTION

FUSES &
FUSE-
HOLDERS

LEDs &
INDICATORS

MINIATURE
SWITCHES

LIMIT &
SAFETY
SWITCHES

CONTROL
PRODUCTS

INTERFACE
MODULES &
SUPPORTS

RELAY
BASES

ENCLOSURES

BATTERIES

TRANS-
FORMERS



+44 (0)1638 716101
info@camdenboss.com
www.camdenboss.com

We operate a constant improvement policy,
our products are subject to change without notice.

CAMDENBOSS
ELECTRONICS & ENCLOSURES

X-ON Electronics

Largest Supplier of Electrical and Electronic Components

Click to view similar products for [9V Battery Snaps & Contacts](#) category:

Click to view products by [Camden](#) manufacturer:

Other Similar products are found below :

[139B](#) [173P](#) [266](#) [491-SC36](#) [642-S](#) [1295](#) [12BC2202-GR](#) [2238](#) [2241](#) [2242](#) [2243](#) [227](#) [236](#) [237](#) [2410.0301-01](#) [262](#) [270](#) [271](#) [121-0626/I-GR](#)
[121-0426/IM-GR](#) [121-0626/T-GR](#) [121-0826/T-GR](#) [121-1026/I-GR](#) [12BH617T-GR](#) [123-5025-GR](#) [12BC269-GR](#) [12BH615D-GR](#) [121-](#)
[0624/O-GR](#) [GEM-V36](#) [531-SWHOX](#) [971-SB](#) [T-91-SC3](#) [632-DA](#) [634-DA](#) [636-S](#) [635-S](#) [632S TWIN DIVIDER](#) [3C-30A2-S](#) [3B-30A2-S](#)
[534-SS](#) [491-S](#) [L-2-S](#) [971-SO](#) [972-S](#) [606-1300-011](#) [606-1800-012](#) [616-1800-247](#) [6254-OB](#) [6289-PP](#) [6289-CC](#)