

60x60x38 mm

SUNON

Power Motor Fan

41.5~56.5 CFM



Model	P/N	Bearing ● VAPO ⊙ 2BALL	Rating Voltage (VDC)	Power Current (AMP)	Power Consumption (WATTS)	Speed (RPM)	Air Flow (CFM)	Static Pressure (Inch-H ₂ O)	Noise (dBA)	Weight (g)
PMD1206PMB1-A	(2).GN	⊙	12	0.88	10.6	8000	56.5	0.92	56	90
PMD1206PMB2-A	(2).GN	⊙	12	0.58	7.0	7000	49.2	0.71	52	90
PMD1206PMB3-A	(2).GN	⊙	12	0.43	5.2	6000	41.5	0.53	47	90
PMD2406PMB1-A	(2).GN	⊙	24	0.43	10.3	8000	56.5	0.92	56	90
PMD2406PMB2-A	(2).GN	⊙	24	0.31	7.4	7000	49.2	0.71	52	90
PMD2406PMB3-A	(2).GN	⊙	24	0.22	5.3	6000	41.5	0.53	47	90
PMD4806PMB1-A	(2).GN	⊙	48	0.24	11.5	8000	56.5	0.92	56	90
PMD4806PMB2-A	(2).GN	⊙	48	0.18	8.6	7000	49.2	0.71	52	90
PMD4806PMB3-A	(2).GN	⊙	48	0.13	6.2	6000	41.5	0.53	47	90

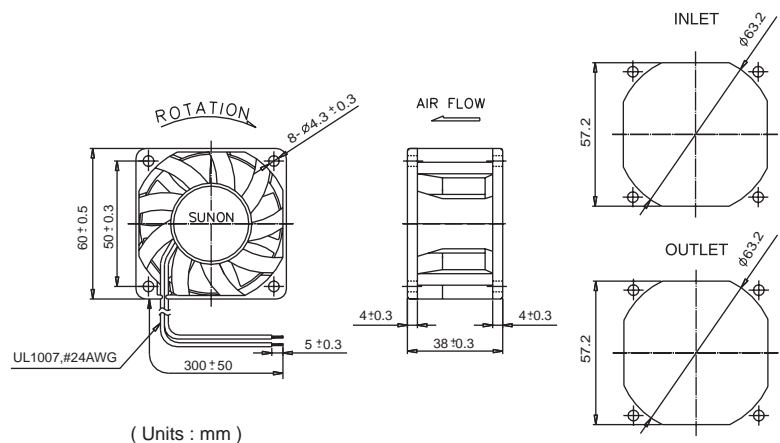
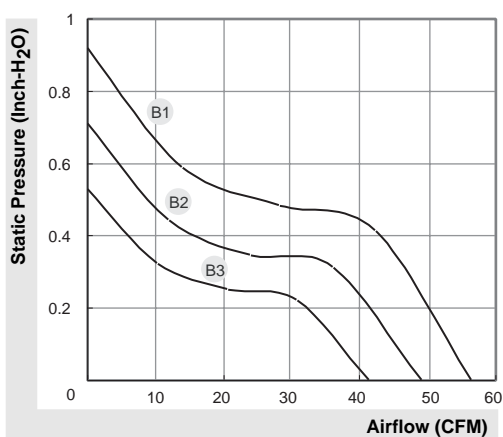

*All model could be customized on voltage or any other requirements to fit your need.

*Specifications subject to change without notice. Please Visit SUNON web site at <http://www.sunon.com> for update information.

Fan 3rd Wire Signal

Fan with switching driving circuit designed for rpm measurement:

These fan motors have three lead wires:

+:Red,

-:Black,

output signal for 3rd wire:

F Type : Yellow

R Type : White

● R Type (Rotation Detector)

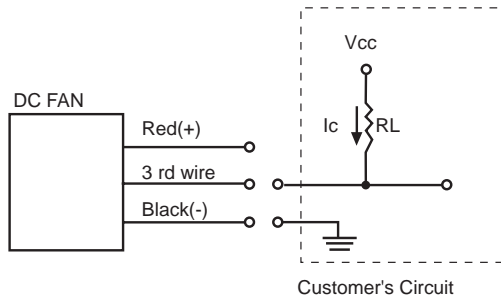
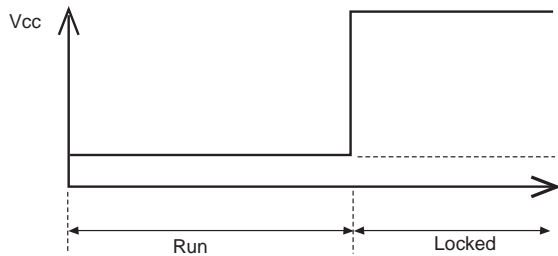

● F Type (Frequency Generator)

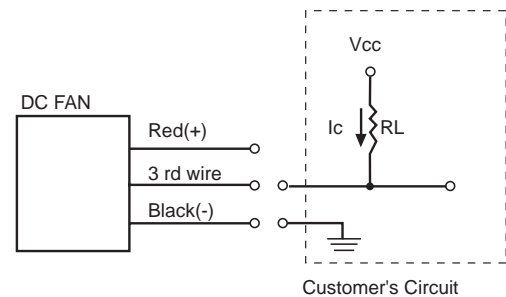
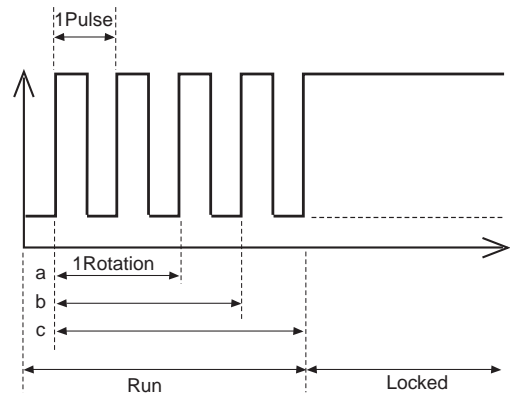

The relationship between rotation & output pulses signal from 3rd wire are as follows:

(a) 1 Rotation=2 Pulses(4 poles' motor)

(b) 1 Rotation=3 Pulses(6 poles' motor)

(c) 1 Rotation=4 Pulses(8 poles' motor)

Notice:

For 8 poles' motor: normally,

1Rotation=4 pulses, if frequency divided circuit is implemented in this motor then

1Rotation=2 pulses.

Safety



DC Fan and Blower Model Numbering System

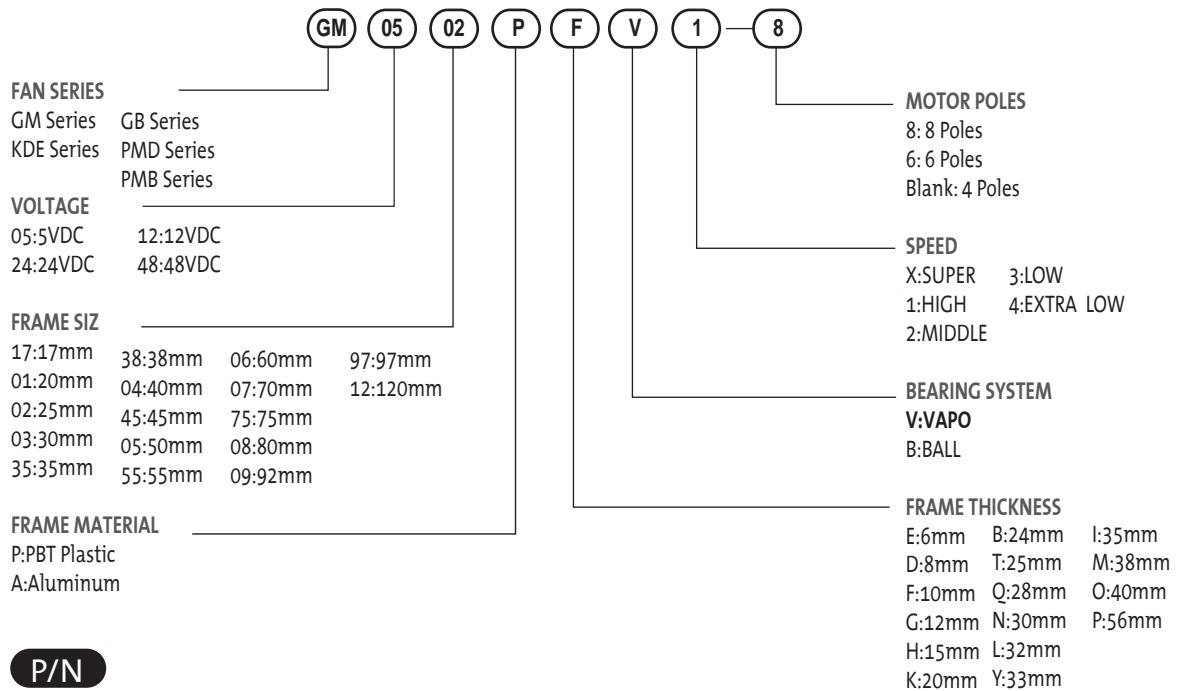

P/N

Example: KDE1208PTV1 P/N:13.MS.A.GN

- 11/13 Motor model
- MS MagLev Design
- (2) Two ball bearing
- G Big hub
- (9) 9 Blades
- N Smaller hub
- A Auto restart
- F 3rd wire with frequency generation waveform
- R 3rd wire with rotation detector waveform
- U Upgrade
- GN RoHS compliance

Sunon Connector recommendation

Connector pitch	Manufacturer	Housing	Terminal
1.25mm	HIROSE	DF13-2S-1.25C	DF13-2630SCF
	MOLEX	51021-0300	50058-8200
1.5mm	JST	ZHR-2	SZH-002T-P0.5 or SZH-003T-P0.5
2.0mm	JST	PHR-2	SPH-002T-P0.5S
2.54mm	ECI	2510-02	2511-P
	Molex	50-57-9405	16-02-0069(70058-0004) or 16-02-0082(70058-0006)
	Molex	2695-02RP	2759T(39-00-0372)
	Molex	2695-03RP	2759T(39-00-0372)
	Molex	6471-021	4809-C-P914
2.50mm	Molex	6471-031	4809-C-P914
	JAM	SC25-02HG	725462-2MA
	JST	SMR-02V-B	SYM-001T-P0.6
	JST	XHP-2	SXH-001T-0.6
	JST	EHR-2(H28J-2)	SEH-001T-P0.6
	JST	SMP-02V-BC	SHF-001T-0.8BS
	JWT	A2502H02-2P	A2502TOP-2
	JWT	A2502H02-3P	A2502TOP-2
	Molex	5051-02	2759T(39-00-0372)
Molex	5264-02	5263PBT(08-70-1039)	

X-ON Electronics

Largest Supplier of Electrical and Electronic Components

Click to view similar products for [DC Fans](#) category:

Click to view products by [Sunon](#) manufacturer:

Other Similar products are found below :

[614R](#) [6424/2HP-210](#) [8312R](#) [DV4118/2NP-183](#) [AFB0948HH-S687](#) [PFB0824DHE-8B72](#) [G2E085-AA05-10](#) [RD20S-4/210660](#) [4318/12T](#)
[4418HH](#) [AUB0912H-F00](#) [3412N/2ME](#) [K2E225-RA92-09](#) [4184N/2XR](#) [5214N2HH](#) [614J2HHPR-010](#) [8412NGL-12](#) [4114N/12HHR-297](#)
[4656](#) [ZWR-903](#) [4112N12GL-175](#) [KD2406PKB2.\(2\).GN](#) [AFB1248HHE](#) [AFB1212LE-F00](#) [FAN-SCH-1](#) [MF60151V1-1000U-G99](#)
[PF80252V1-1000U-G99](#) [PF92252V1-1000U-G99](#) [4112N/2H6P](#) [4114N/17-251](#) [6212NH](#) [622/2N](#) [712F-011](#) [8218J/2NP-181](#) [W1G180-AB47-](#)
[15](#) [FAA1-12038NBKW31-A](#) [6318N/2TDP](#) [6318N/2H3PU](#) [6318HU](#) [424JMU](#) [PMD1206PTVX-A.U.GN](#) [PF80251B2-000U-F99](#)
[EF40101BX-1000U-G99](#) [AD1224LB-A71GL](#) [9GA0924L4021](#) [9GA0924M4021](#) [9GA0924M4011](#) [9GA0824B20011](#) [9GA0812A2D0011](#)
[9GA0912M4D011](#) [9GA0924W4D01](#)