

RF1284

**319.508 MHz
SAW Filter**

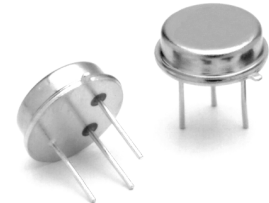

TO39-3 Case

- **Ideal Front-End Filter for European Wireless Receivers**
- **Low-Loss, Coupled-Resonator Quartz Design**
- **Simple External Impedance Matching**
- **Rugged TO39 Hermetic Package**
- **Complies with Directive 2002/95/EC (RoHS)**



The RF1284 is a low-loss, compact and economical surface-acoustic-wave (SAW) filter designed to provide front-end selectivity in 319.508 MHz receivers. Receiver designs using this filter include superhet with 10.7 MHz or 500 kHz IF, direct conversion and superregen.

This coupled-resonator filter (CRF) uses selective null placement to provide suppression, typically greater than 40 dB, of the LO and image spurious responses of superhet receivers with 10.7 MHz IF. RFM's advanced SAW design and fabrication technology is utilized to achieve high performance and very low loss with simple external impedance matching (not included). Quartz construction provides excellent frequency stability over a wide temperature range.

Characteristic	Sym	Notes	Minimum	Typical	Maximum	Units	
Center Frequency at 25°C Absolute Frequency	f_c	1, 2	319.428		319.588	MHz	
	Tolerance from 319.500 MHz		Δf_c		± 80	kHz	
Insertion Loss	IL	1		2.0	3.0	dB	
3 dB Bandwidth	BW_3	1, 2	500	600	800	kHz	
Rejection	at $f_c - 21.4$ MHz (Image) at $f_c - 10.7$ MHz (LO) Ultimate	1	40	50		dB	
			15	40			
				80			
Temperature	Operating Case Temperature	T_C	3, 4	-40		+85	°C
	Turnover Temperature	T_O		15	25	35	°C
	Turnover Frequency	f_O			f_c		MHz
	Frequency Temperature Coefficient	FTC			0.032		ppm/°C ²
Frequency Aging	Absolute Value during the First Year	Δf	5		≤ 10	ppm/yr	
Impedance @ f_c	Input $Z_{IN}=R_{IN}/C_{IN}$	Z_{IN}	1	1570Ω//6.84pf		nH	
	Output $Z_{OUT}=R_{OUT}/C_{OUT}$	Z_{OUT}	1	1490Ω//7.02pf		pF	
Lid Symbolization (in addition to Lot and/or Date Codes)			RFM // RF1284 // YYWWS##				



CAUTION: Electrostatic Sensitive Device. Observe precautions for handling.

NOTES:

1. Unless noted otherwise, all measurements are made with the filter installed in the specified test fixture which is connected to a 50 Ω test system with VSWR ≤ 1.2:1. The test fixture L and C are adjusted for minimum insertion loss at the filter center frequency, f_c . Note that insertion loss, bandwidth, and passband shape are dependent on the impedance matching component values and quality.
2. The frequency f_c is defined as the midpoint between the 3dB frequencies.
3. Where noted, specifications apply over the entire specified operating temperature range.
4. The turnover temperature, T_O , is the temperature of maximum (or turnover) frequency, f_O . The nominal frequency at any case temperature, T_C , may be calculated from: $f = f_O [1 - FTC (T_O - T_C)^2]$.
5. Frequency aging is the change in f_c with time and is specified at +65°C or less. Aging may exceed the specification for prolonged temperatures above +65°C. Typically, aging is greatest the first year after manufacture, decreasing significantly in subsequent years.
6. The design, manufacturing process, and specifications of this device are subject to change without notice.
7. One or more of the following U.S. Patents apply: 4,54,488, 4,616,197, and others pending.
8. All equipment designs utilizing this product must be approved by the appropriate government agency prior to manufacture or sale.

Absolute Maximum Ratings

Rating	Value	Units
Incident RF Power	+13	dBm
DC Voltage Between Any Two Pins (Observe ESD Precautions)	±30	VDC
Case Temperature ⁵	-40 to +85	°C

Typical Filter Response

Typical filter responses are shown below. The actual response is dependent on external impedance matching and circuit layout. Illustrated frequencies and minimum rejection for LO and IMAGE are shown only for superhet receivers with 10.7 MHz IF.

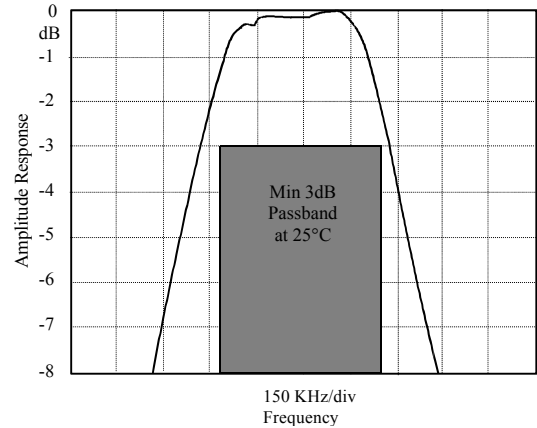
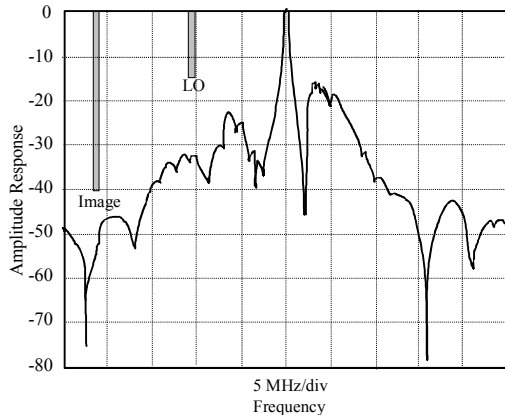

Electrical Connections

Pin	Connection
1	Input or Output
2	Output or Input
3	Case Ground

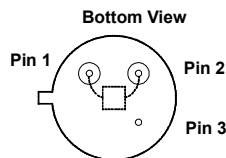

Case Design

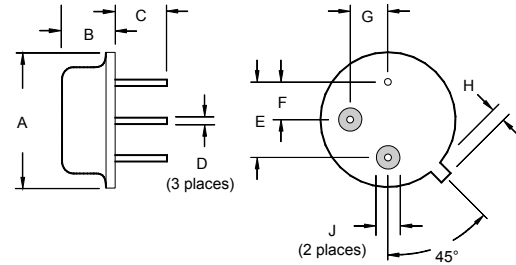

Typical Test Circuit

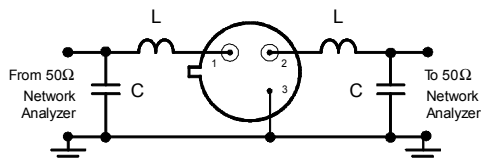

Dimensions	Millimeters		Inches	
	Min	Max	Min	Max
A		9.30		0.366
B		3.18		0.125
C	2.50	3.50	0.098	0.138
D	0.46 Nominal		0.018 Nominal	
E	5.08 Nominal		0.200 Nominal	
F	2.54 Nominal		0.100 Nominal	
G	2.54 Nominal		0.100 Nominal	
H		1.02		0.040
J	1.40		0.055	

19 Apr 2007 09:49:09

CH1 S11 1 UFS 1: 53.895 Ω 9.0879 Ω 4.5270 nH 319.500 000 MHz

hp
RF1284 DEMO DEVICE #98
FULL 2 PORTS CAL.

Cor

Full

↑

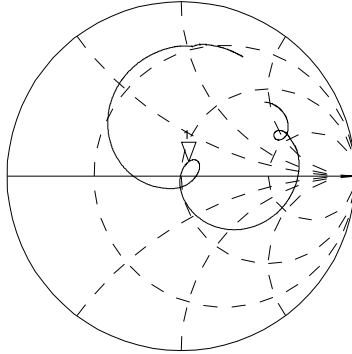

CH2 S22 1 UFS 1: 49.963 Ω 8.5449 Ω 4.2565 nH 319.500 000 MHz

Cor

Full

↑

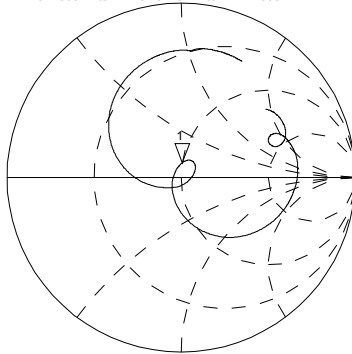

CENTER 319.500 000 MHz

SPAN 2.000 000 MHz

19 Apr 2007 09:49:37

CH1 S21 LOG 1 dB/ REF -2.9 dB 1: 0.000 dB 0.000 000 MHz

hp
RF1284 DEMO DEVICE #98
THRU CAL.

Cor

Resp

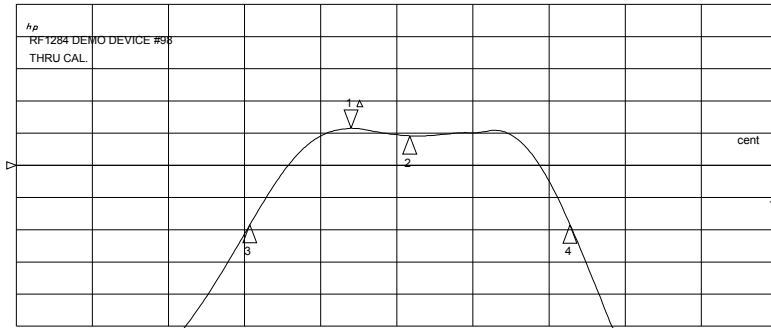

CH1 Markers

Max Δ REF=1

BW: .673195 MHz

cent : 319.535654 MHz

Q: 474.66

1 loss : -1.7450 dB

CH2 S21 LOG 10 dB/ REF -2.9 dB 1: -1.9228 dB 319.500 000 MHz

Cor

Resp

↑

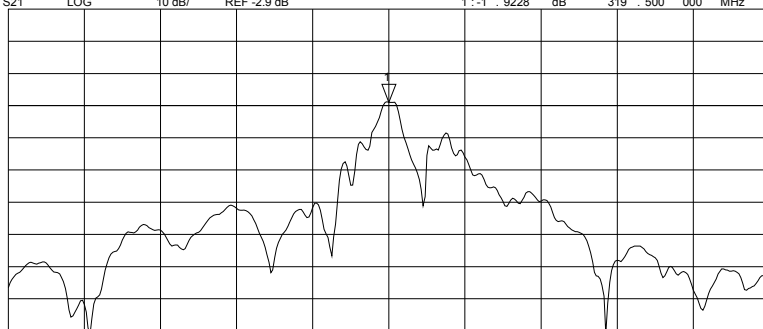

CH2 CENTER 319.500 000 MHz

SPAN 30.000 000 MHz

19 Apr 2007 09:50:51

CH1 S11 1 UFS 1: 44.488 Ω 12.287 Ω 6.1207 nH 319.500 000 MHz

hp
RF1284 DEMO DEVICE #99
FULL 2 PORTS CAL.

Cor

Full

↑

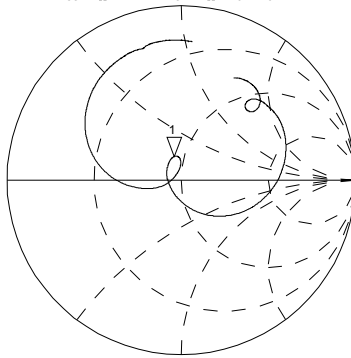

CH2 S22 1 UFS 1: 54.975 Ω 10.461 Ω 5.2110 nH 319.500 000 MHz

Cor

Full

↑

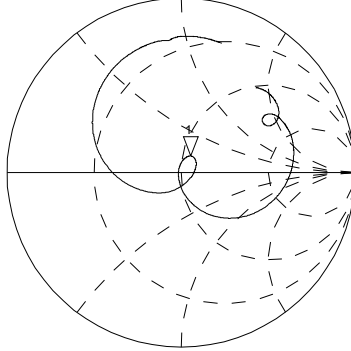

CENTER 319.500 000 MHz

SPAN 2.000 000 MHz

19 Apr 2007 09:51:09

CH1 S21 LOG 1 dB/ REF -2.9 dB 1: 0.0000 dB 0.000 000 MHz

hp
RF1284 DEMO DEVICE #99
THRU CAL.

Cor

Resp

↑

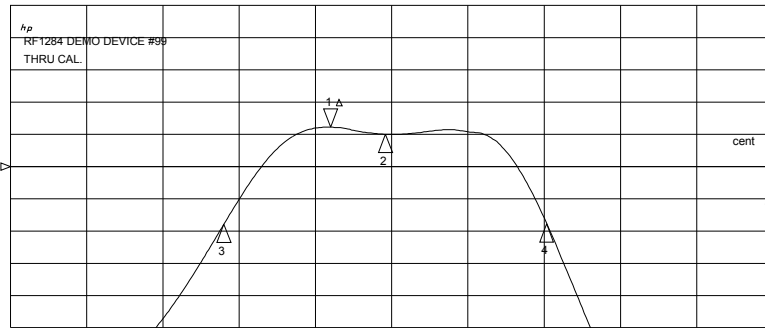

CH1 Markers
Max Δ REF=1
BW: .677150 MHz
cent: 319.494904 MHz
Q: 471.82
1_loss: -1.6733 dB

CH2 S21 LOG 10 dB/ REF -2.9 dB 1: -1.8845 dB 319.500 000 MHz

Cor

Resp

↑

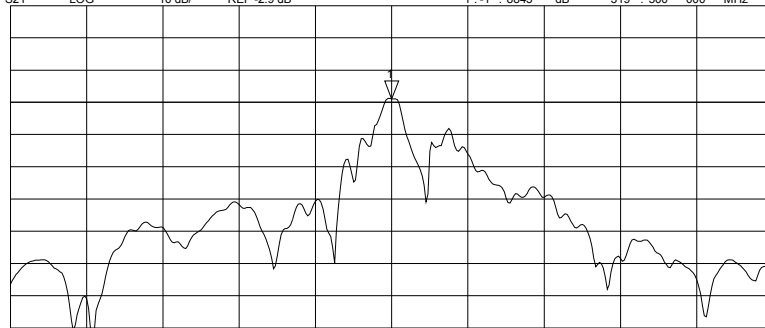

CH2 CENTER 319.500 000 MHz

SPAN 30.000 000 MHz

19 Apr 2007 09:52:20

CH1 S11 1 U FS 1: 57.795 Ω 15.191 Ω 7.5674 nH 319.500 000 MHz

h_p
RF1284 DEMO DEVICE #100
FULL 2 PORTS CAL.

Cor

Full

↑

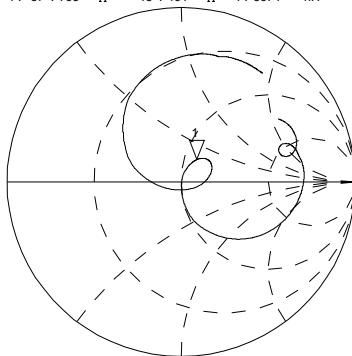

CH2 S22 1 U FS 1: 52.545 Ω 13.787 Ω 6.8679 nH 319.500 000 MHz

Cor

Full

↑

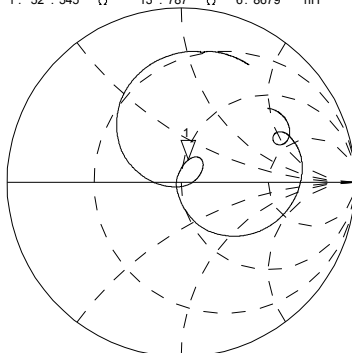

CENTER 319.500 000 MHz

SPAN 2.000 000 MHz

19 Apr 2007 09:52:50

CH1 S21 LOG 1 dB/ REF -2.9 dB 1: 0.000 dB 0.000 000 MHz

h_p
RF1284 DEMO DEVICE #100
THRU CAL

Cor

Resp

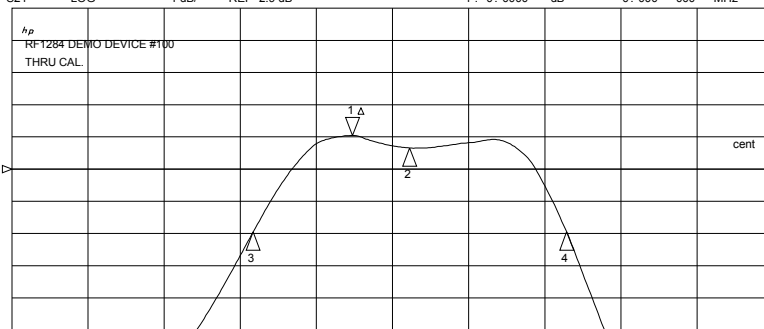

CH1 Markers
Max Δ REF=1
BW: .658896 MHz
cent : 319.544482 MHz
Q: 484.97
1_loss : -1.8522 dB

CH2 S21 LOG 10 dB/ REF -2.9 dB 1: -2.1396 dB 319.500 000 MHz

Cor

Resp

↑

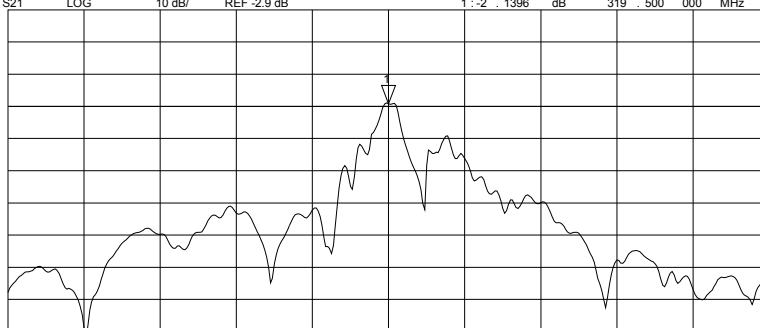

CH2 CENTER 319.500 000 MHz

SPAN 30.000 000 MHz

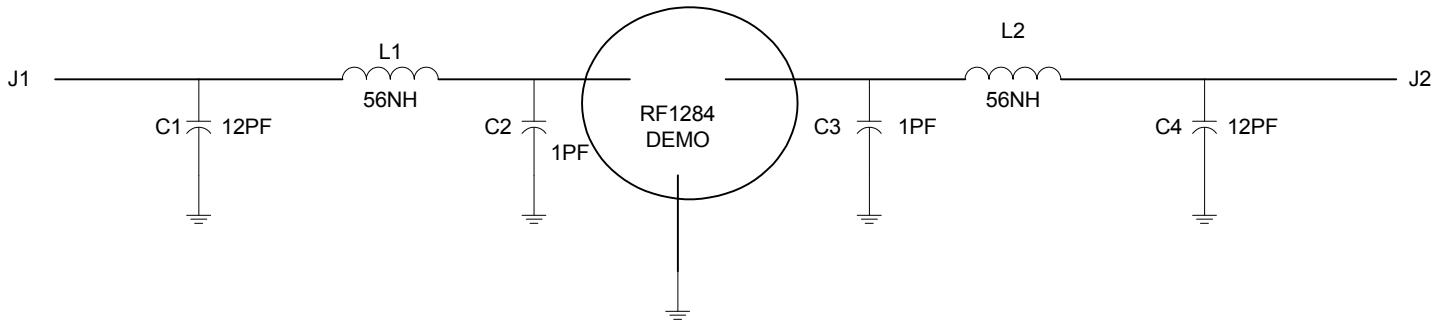

PCB,	400-0455-001	
IND,	501-0966-560, 1008CS 56NH	L1, L2
CAP,	501-1275-010, 0805, 1PF	C2, C3
CAP,	501-1275-120, 0805, 12PF	C1, C1

X-ON Electronics

Largest Supplier of Electrical and Electronic Components

Click to view similar products for [Signal Conditioning](#) category:

Click to view products by [Murata](#) manufacturer:

Other Similar products are found below :

[MAPDCC0004](#) [PD0409J5050S2HF](#) [880157](#) [HHS-109-PIN](#) [DC1417J5005AHF](#) [DC4859J5005AHF](#) [AFS14A30-2185.00-T3](#) [AFS14A35-1591.50-T3](#) [DS-323-PIN](#) [DSS-313-PIN](#) [B39321R801H210](#) [B39321R821H210](#) [B39921B4317P810](#) [1A0220-3](#) [2089-6207-00](#) [JP510S](#) [LFB212G45SG8C341](#) [LFB322G45SN1A504](#) [LFL182G45TC3B746](#) [SF2159E](#) [30057](#) [1P510S](#) [CER0813B](#) [3A325](#) [40287](#) [41180](#) [ATB3225-75032NCT](#) [B69842N5807A150](#) [BD0810N50100AHF](#) [BD2326L50200AHF](#) [BD2425J50200AHF](#) [HMC189AMS8TR](#) [C5060J5003AHF](#) [JHS-114-PIN](#) [JP503AS](#) [DC0710J5005AHF](#) [DC2327J5005AHF](#) [DC3338J5005AHF](#) [43020](#) [LFB2H2G60BB1C106](#) [LFL15869MTC1B787](#) [X3C19F1-20S](#) [XC3500P-20S](#) [10013-20](#) [SF2081E](#) [SF2194E](#) [SF2238E](#) [CDBLB455KCAX39-B0](#) [RF1353C](#) [PD0922J5050D2HF](#)