

97x94x33 mm

SUNON

Power Motor Blower

22.4~30.5 CFM



Model	P/N	Bearing ● VAPO ⊕ 2BALL	Rating Voltage (VDC)	Power Current (AMP)	Power Consumption (WATTS)	Speed (RPM)	Air Flow (CFM)	Static Pressure (Inch-H ₂ O)	Noise (dBA)	Weight (g)
PMB1297PYB1-AY	(2).GN	⊕	12	0.72	8.6	3600	30.5	0.92	55.8	185
PMB1297PYB2-AY	(2).GN	⊕	12	0.56	6.7	3200	26.6	0.65	53.1	185
PMB1297PYB3-AY	(2).GN	⊕	12	0.30	3.6	2700	22.4	0.43	50.0	185
PMB2497PYB1-AY	(2).GN	⊕	24	0.39	9.4	3600	30.5	0.92	55.8	185
PMB2497PYB2-AY	(2).GN	⊕	24	0.25	6.0	3200	26.6	0.65	53.1	185
PMB2497PYB3-AY	(2).GN	⊕	24	0.16	3.8	2700	22.4	0.43	50.0	185
PMB4897PYB1-AY	(2).GN	⊕	48	0.17	8.2	3600	30.5	0.92	55.8	185
PMB4897PYB2-AY	(2).GN	⊕	48	0.13	6.2	3200	26.6	0.65	53.1	185
PMB4897PYB3-AY	(2).GN	⊕	48	0.09	4.3	2700	22.4	0.43	50.0	185

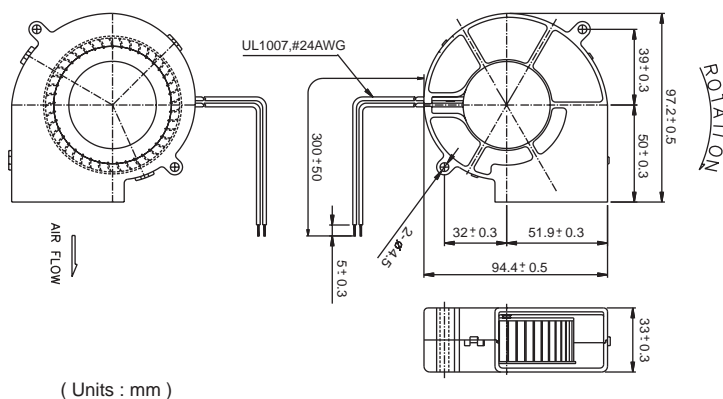
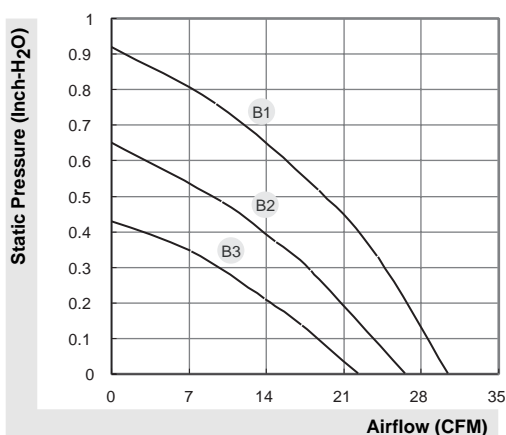

*All model could be customized on voltage or any other requirements to fit your need.

*Specifications subject to change without notice. Please Visit SUNON web site at <http://www.sunon.com> for update information.

Fan 3rd Wire Signal

Fan with switching driving circuit designed for rpm measurement:

These fan motors have three lead wires:

+:Red,

-:Black,

output signal for 3rd wire:

F Type : Yellow

R Type : White

● R Type (Rotation Detector)

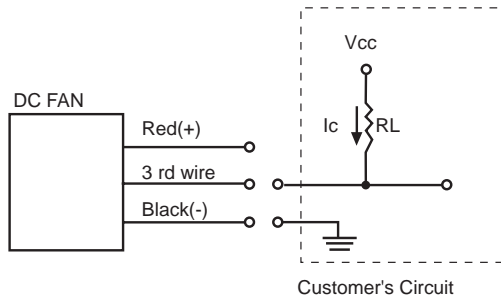
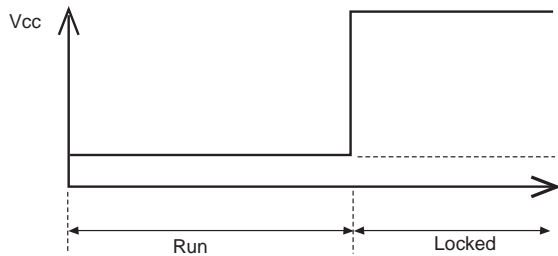

● F Type (Frequency Generator)

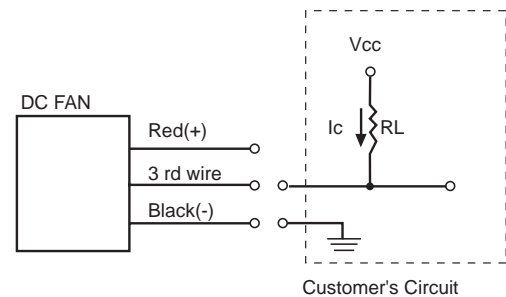
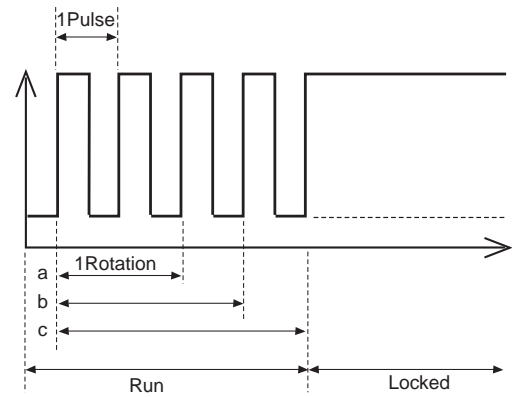

The relationship between rotation & output pulses signal from 3rd wire are as follows:

- (a) 1 Rotation=2 Pulses(4 poles' motor)
- (b) 1 Rotation=3 Pulses(6 poles' motor)
- (c) 1 Rotation=4 Pulses(8 poles' motor)

Notice:

For 8 poles' motor: normally, 1Rotation=4 pulses, if frequency divided circuit is implemented in this motor then 1Rotation=2 pulses.

Safety



Certification



DC Fan and Blower Model Numbering System

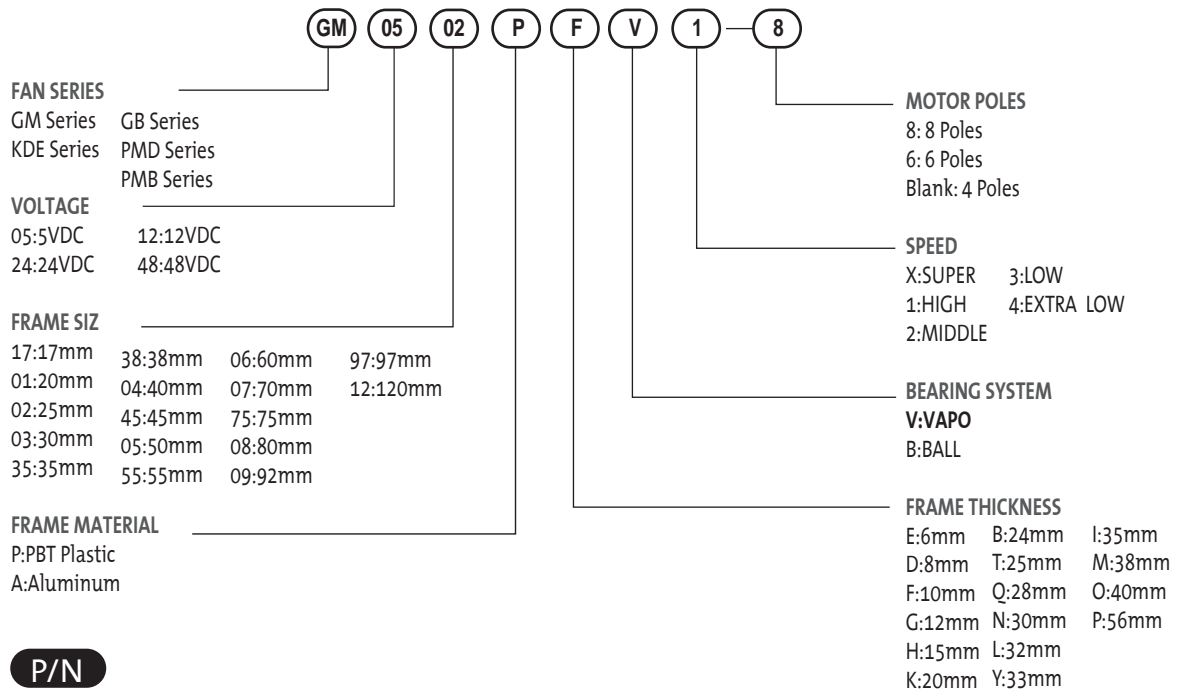

P/N

Example: KDE1208PTV1 P/N:13.MS.A.GN

- 11/13 Motor model
- MS MagLev Design
- (2) Two ball bearing
- G Big hub
- (9) 9 Blades
- N Smaller hub
- A Auto restart
- F 3rd wire with frequency generation waveform
- R 3rd wire with rotation detector waveform
- U Upgrade
- GN RoHS compliance

Sunon Connector recommendation

Connector pitch	Manufacturer	Housing	Terminal
1.25mm	HIROSE	DF13-2S-1.25C	DF13-2630SCF
	MOLEX	51021-0300	50058-8200
1.5mm	JST	ZHR-2	SZH-002T-P0.5 or SZH-003T-P0.5
2.0mm	JST	PHR-2	SPH-002T-P0.5S
2.54mm	ECI	2510-02	2511-P
	Molex	50-57-9405	16-02-0069(70058-0004) or 16-02-0082(70058-0006)
	Molex	2695-02RP	2759T(39-00-0372)
	Molex	2695-03RP	2759T(39-00-0372)
	Molex	6471-021	4809-C-P914
2.50mm	Molex	6471-031	4809-C-P914
	JAM	SC25-02HG	725462-2MA
	JST	SMR-02V-B	SYM-001T-P0.6
	JST	XHP-2	SXH-001T-0.6
	JST	EHR-2(H28J-2)	SEH-001T-P0.6
	JST	SMP-02V-BC	SHF-001T-0.8BS
	JWT	A2502H02-2P	A2502TOP-2
	JWT	A2502H02-3P	A2502TOP-2
	Molex	5051-02	2759T(39-00-0372)
Molex	5264-02	5263PBT(08-70-1039)	

X-ON Electronics

Largest Supplier of Electrical and Electronic Components

Click to view similar products for [Blowers & Centrifugal Fans](#) category:

Click to view products by [Sunon](#) manufacturer:

Other Similar products are found below :

[MKEL-DRB](#) [AIF60111](#) [AIF60112](#) [AIF62112](#) [AIF801724](#) [AIF82111](#) [AIF82112](#) [DOP-EXI014RAE](#) [BR300W100](#) [BR300W400](#)

[KFC1048DS-S45D](#) [AIF64111](#) [AIF641714](#) [AIF802714](#) [CME-COP01](#) [R2E180CH0312](#) [D2E160-AH02-15](#) [TP04G-AS2](#) [TP05G-BT2](#) [TP-PCC](#)

[BR200W250](#) [DFD0612H/SPECTRA](#) [DOP-EXI028RAE](#) [ENA01-MOD](#) [ENA01-EIP](#) [2234000A001-055](#) [2234000A00J000](#) [1396000K911-039](#)

[1319013K66E000](#) [1316037K66E000](#) [1301037K00E000](#) [1301037G00E002](#) [TP08G-BT2](#) [1232000A00E000](#) [1213000A07E000](#) [55442.40890](#)

[55462.19140](#) [G2E140-AG02-05](#) [55410.91750](#) [R2E190-RA18-96](#) [R2E225-RA02-47](#) [AB1212LB-Y01](#) [R4D450-AK03-05](#) [RLF100-11/14/19](#)

[BFB04512HD-R00](#) [G2D140-AC30-18](#) [R2E225-AB05-05](#) [M39012/24-0001](#) [K2E220-RA38-09](#) [55462.40760](#)