

LOC	DIST	REVISIONS					
E	B	P	LTR	DESCRIPTION	DATE	DWN	APVD
			BA	NEW RELEASE	20-Sep-08	SM	St.P

FOR FURTHER INFORMATION SEE DATA SHEET FOR
CFR SERIES-CARBON FILM FIXED RESISTORS

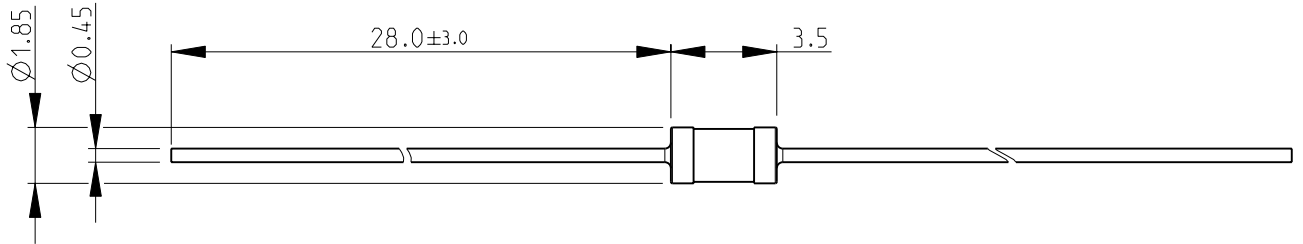

RoHS Compliant

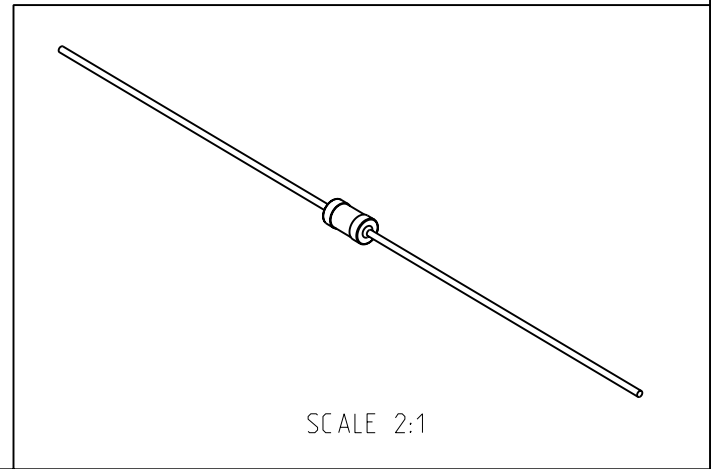

SCALE 2:1

2008

RELEASED FOR PUBLICATION

THIS DRAWING IS UNPUBLISHED.

© COPYRIGHT 2008 BY TYCO ELECTRONICS CORPORATION. ALL RIGHTS RESERVED.

DIMENSIONS: mm	DWN	20-Sep-08	MATERIAL	-	FINISH	-
	CHK	20-Sep-08	Tyco Electronics Corporation Dorcan, Swindon, SN3 5HH			
TOLERANCES UNLESS OTHERWISE SPECIFIED:	APVD	20-Sep-08				
	0 PLC	± 0.2	NAME	CARBON FILM FIXED RESISTORS SERIES CFR16		
1 PLC	± 0.1	PRODUCT SPEC	SIZE	CAGE CODE	DRAWING NO	RESTRICTED TO
2 PLC	$\pm -$	APPLICATION SPEC	A 4	00779	©- 1623927	-
3 PLC	$\pm -$	WEIGHT	CUSTOMER DRAWING			
4 PLC	$\pm -$		SCALE	4:1	SHEET	1 OF 1
ANGLES	$\pm 5^\circ$		REV BA			

X-ON Electronics

Largest Supplier of Electrical and Electronic Components

Click to view similar products for [Carbon Film Resistors - Through Hole](#) *category:*

Click to view products by [TE Connectivity](#) *manufacturer:*

Other Similar products are found below :

[150-04720](#) [OMT200L](#) [ON2725E](#) [CFR16J1K0](#) [CFR50J8K2](#) [CFS1/2C512J](#) [CFR200J120R](#) [CFR25J3M9](#) [CFR25J6R8](#) [CFR25J75R](#) [CFS1/4 C](#)
[100 J](#) [CFR50J3M3](#) [OB1065](#) [OH4315](#) [LCA0207004701JD500](#) [LCA0207001002J2500](#) [LCA0207004701J2500](#) [LCA0414004700J2100](#)
[CFR200G220R](#) [291-0.82-RC](#) [150-01011](#) [MFR5-560KFI](#) [Z16LT52R](#) [MFS14CC3300F](#) [MFS1/4CC6201F](#) [MFS1/4CC68R0F](#)
[RNR55C3321FSM76](#) [MRS25000C1741FC100](#) [RWR80S1821FRB12](#) [RWR81S24R9FRS73](#) [RWR89S1000FRS73](#) [NMO100J273TRF](#) [CFR-](#)
[25JB-52-4K3](#) [CFR-25JB-52-4R7](#) [CFR-50JB-52-4R7](#) [SPR1C391J](#) [SPR1CT52A472J](#) [SPR1CT52R1002F](#) [SPR1CT52R100J](#) [SPR1CT52R102J](#)
[SPR1CT52R103J](#) [SPR1CT52R220J](#) [SPR1CT52R222J](#) [SPR1CT52R332J](#) [SPR1CT52R471J](#) [SPR1CT52R561J](#) [SPR2C103J](#) [SPR2C183J](#)
[SPR2C680J](#) [SPR2CT521R181J](#)