

FILTERING

SPLIT FERRITES FOR ROUND CABLE

patented

Features

- Employ high-performance ferrites (Nickel-Zinc) effective against high frequency noise
- Ferrite assembly in fully enclosed Nylon 6/6 case can be installed as a single add-on component by snapping. (UL 94 V-0)
- Designed to help reduce cost and time to market saving.
- Can be installed in its intended location before or after product assembly by snapping.

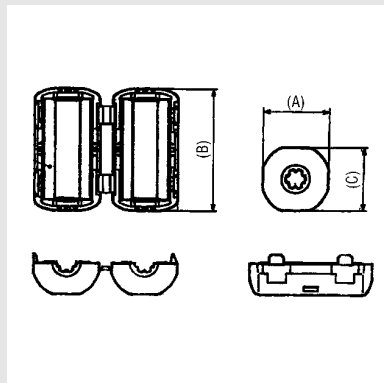

Part No.	Unit: mm			Impedance (Ω) 1 turn		Impedance (Ω) 2 turn		Max. Cable Diameter
	A	B	C	25MHz	100MHz	25MHz	100MHz	
USB-4	13,9	27,0	13,6	122	168	443	614	\emptyset 5,5
RFC-4	14,5	28,6	13,8	56	149	198	584	\emptyset 4,5
RFC-5	18,5	34,0	17,8	53	177	126	864	\emptyset 5,5
RFC-6	18,5	34,0	17,8	53	177	126	864	\emptyset 6,5
RFC-8	20,6	34,0	19,8	49	150	173	658	\emptyset 9,0
RFC-9	22,6	34,0	21,4	64	183	242	760	\emptyset 10,0
RFC-10	26,6	34,0	25,4	95	236	371	1036	\emptyset 11,0
RFC-13	29,6	34,0	28,4	90	209	363	878	\emptyset 14,0
RFC-H13	31,7	41,0	29,4	200	270	-	-	\emptyset 13,5

Black plastic case available (-BK)

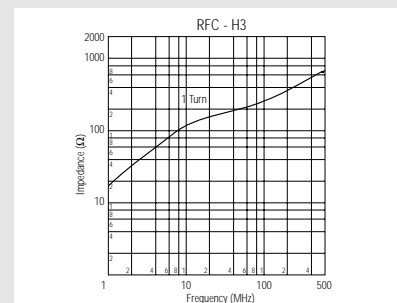
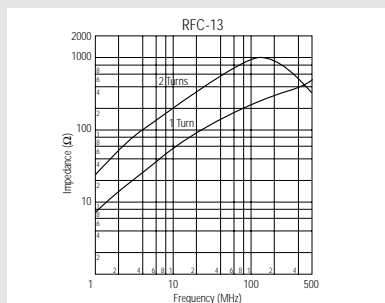
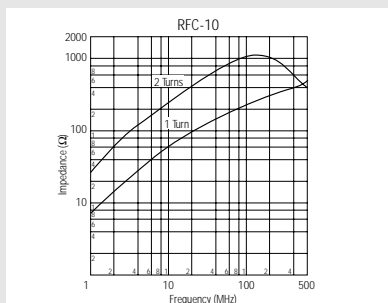
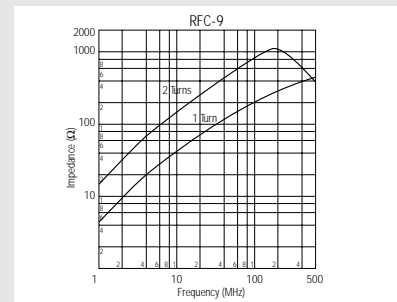
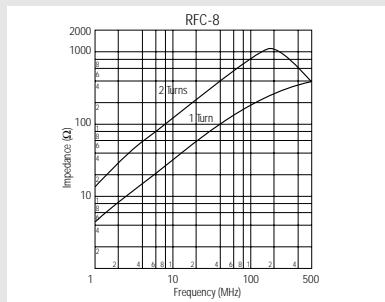
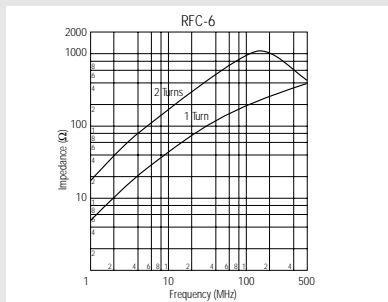
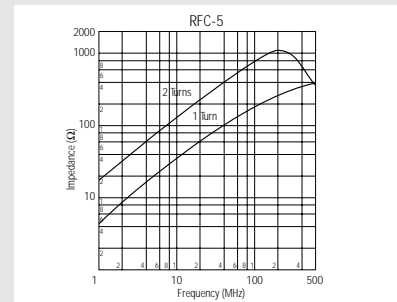
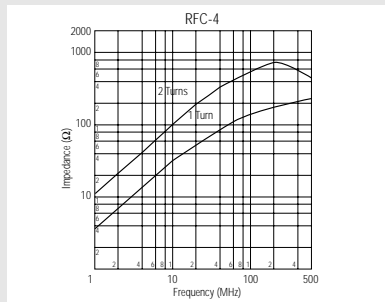
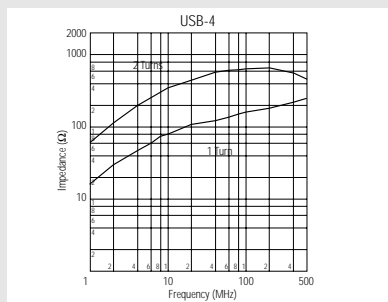

KE KITAGAWA

Elbinger Straße 3-5 · D-63110 Rodgau-Jügesheim · Germany · Telefon 0 61 06/85 24 - 0 · Telefax 0 61 06/85 24-30 (31)

Features

- Employ high-performance ferrites (Nickel-Zinc) effective against high frequency noise
- Ferrite assembly in fully enclosed Nylon 6/6 case, can be installed as a single add-on component by snapping. (UL 94 V-0)
- Spring stainless steel (SUS 304-CSP) incorporates ensure a tighter surface contact between ferrites for a consistent performance.
- Designed to help reduce cost and time to market saving.
- Can be installed in its intended location before or after product assembly by snapping.

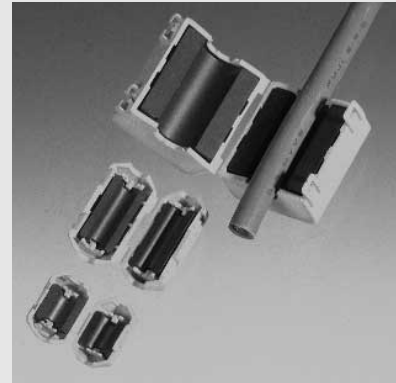
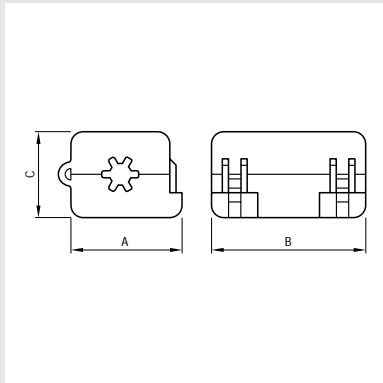

Part No.	Unit: mm			Impedance (Ω) 1 turn		Impedance (Ω) 2 turn		Max. Cable Diameter
	A	B	C	25MHz	100MHz	25MHz	100MHz	
SFC-3	13.4	18.9	13.2	45	80	163	301	$\varnothing 3$
SFC-4	16.3	29.5	15.0	96	138	401	522	$\varnothing 4$ to $\varnothing 5$
SFC-5	21.0	32.0	17.5	177	242	660	766	$\varnothing 5$ to $\varnothing 6$
SFC-6	23.5	32.0	20.0	139	207	614	629	$\varnothing 6$ to $\varnothing 7$
SFC-8	23.5	32.0	20.0	137	204	573	663	$\varnothing 7,8$ to $\varnothing 8,5$
SFC-10	32.6	32.0	29.0	149	266	640	733	$\varnothing 9,5$ to $\varnothing 10,5$

Black plastic case available (-BK)

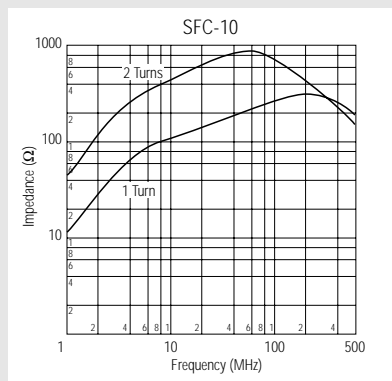
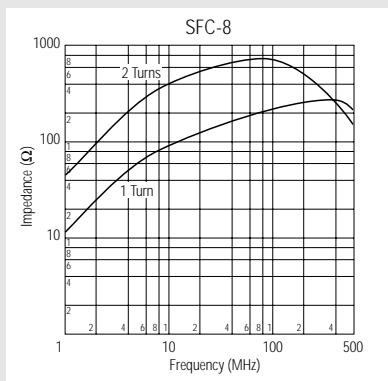
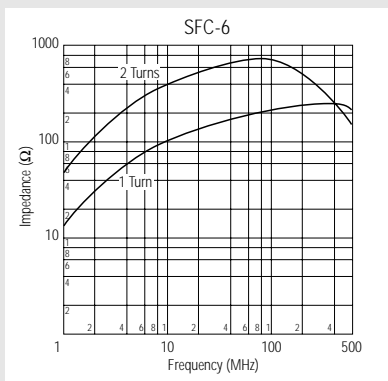
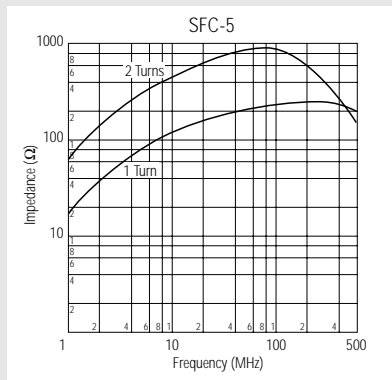
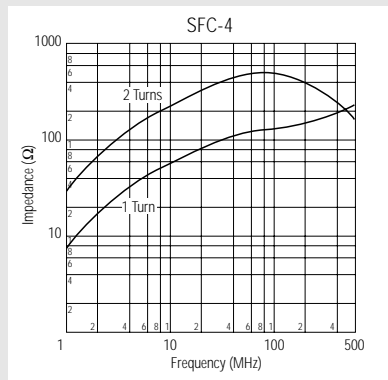
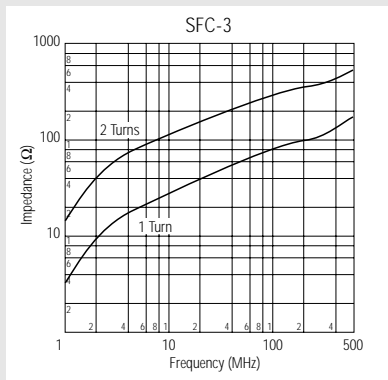

FILTERING

SPLIT FERRITES FOR ROUND CABLE

Features

- Split construction permits easy insertion on pre-installed cable and installed or cables with connectors.
- Kept in a plastic case, ferrite will not crack or chip. (UL 94 V-2)
- Cable is fixed firmly by plastic housing

Applications

- For noise problems arising from office automation equipment or other digital equipment.
- Internal and external power cable.
- Internal cables between PC boards and data connectors.

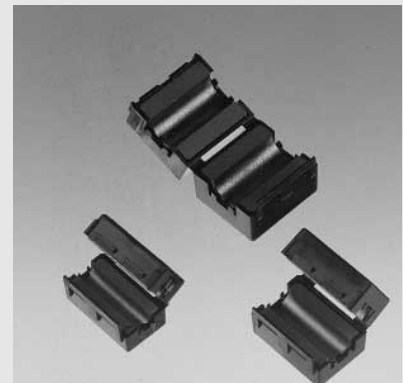
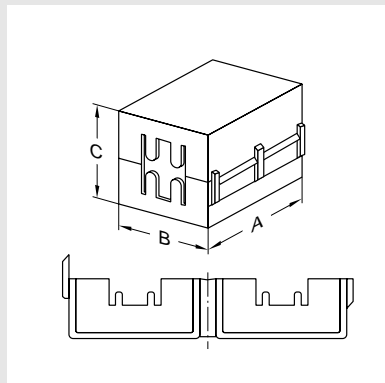

Part No.	Unit: mm			Impedance (Ω)		Max. Cable Diameter
	A	B	C	25MHz	100MHz	
KCF-65	32.6	17.8	19.2	176	267	\varnothing 6.5
KCF-100	32.6	22.5	23.0	151	226	\varnothing 10.0
KCF-130	32.7	29.2	30.2	152	228	\varnothing 13.0

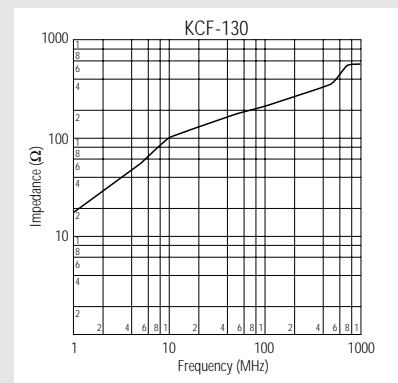
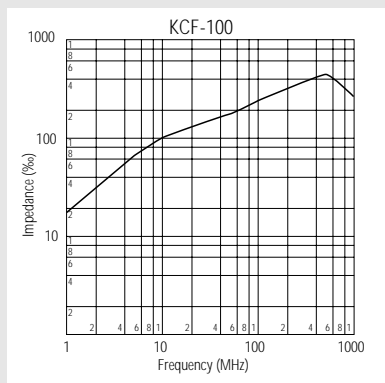
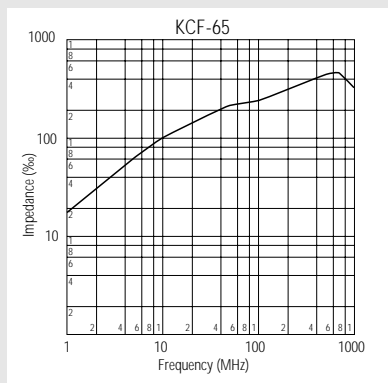

FILTERING

SPLIT FERRITES FOR ROUND CABLE

Features

- Split construction permits easy insertion of cables already wired and installed, or cables with connectors.
- Comes with nylon mounting clamp.
- Clamps are made of UL recognized 6/6 nylon (UL94V-2)

Application

For noise problems arising from office automation equipment or other digital equipment.

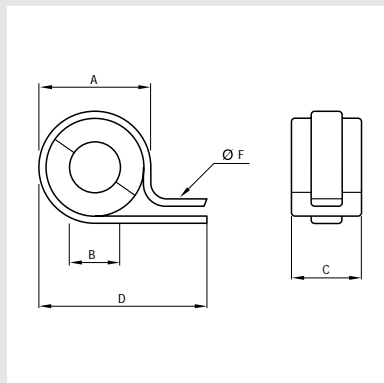

Part No.	Unit: mm					Impedance (Ω) 1 turn		Impedance (Ω) 2 turn		Max. Cable Diameter
	A	B	C	D	F	25MHz	100MHz	25MHz	100MHz	
TRCN-16-8-13	19.4	8.2	13.0	30.2	4.3	59	93	231	396	ϕ 8.0 or less
TRCN-16-8-16	19.4	8.2	16.0	30.2	4.3	64	106	291	504	ϕ 8.0 or less
TRCN-20-10-10	25.7	10.4	10.0	38.2	5.1	53	84	203	360	ϕ 10.0 or less
TRCN-23-11-14	26.8	11.4	14.0	39.4	5.1	72	112	289	449	ϕ 11.0 or less
TRCN-28-16-13	32.8	16.4	13.0	45.0	5.1	56	90	226	374	ϕ 16.0 or less
TRCN-28-16-20	32.8	16.4	20.0	45.0	5.1	79	135	325	579	ϕ 16.0 or less
TRCN-40-27-15	44.6	27.4	15.0	57.3	5.1	48	84	195	365	ϕ 27.0 or less

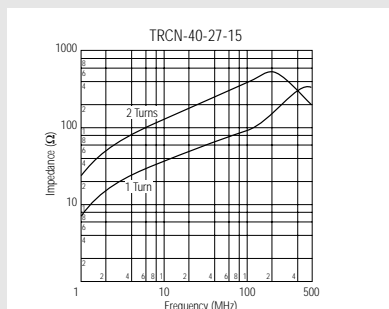
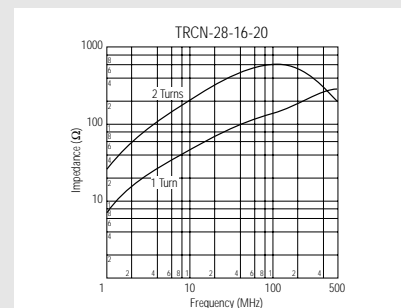
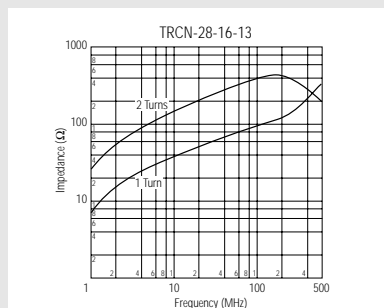
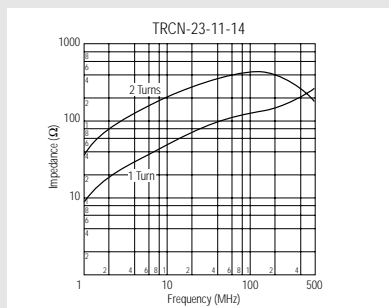
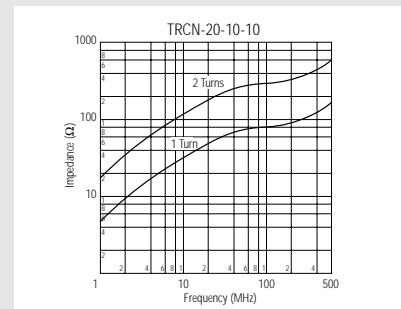
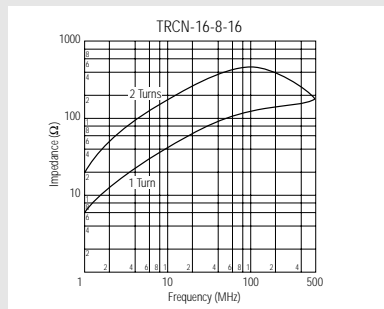
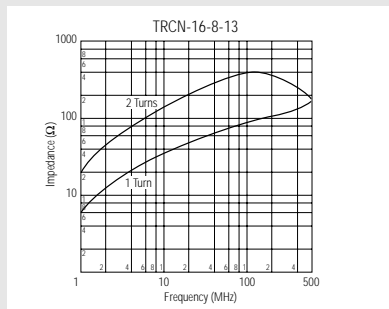

KE KITAGAWA

Elbinger Straße 3-5 · D-63110 Rodgau-Jügesheim · Germany · Telefon 0 61 06/85 24 - 0 · Telefax 0 61 06/85 24-30 (31)

Features

- Employ high-performance ferrites (Nickel-Zinc) effective against high frequency noise
- Ferrite assembly in fully enclosed Nylon 6/6 case, can be installed as a single add-on component by snapping. (UL 94 V-0)
- Special mounting options include adhesive tape, or screw type through holes provided.

Application

- Superior suppression of radiation emissions for full compliance with FCC, VDE and VCCI on interface/ data line round cables of computers, peripheral/terminal equipment.

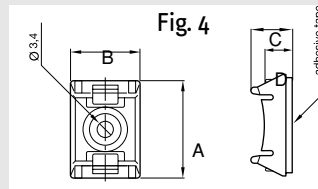
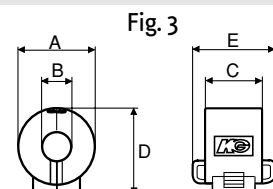
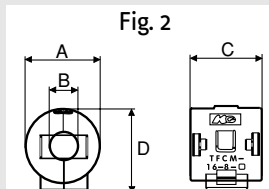
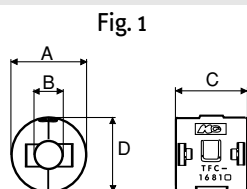

Part No.	Fig.	Unit: mm					Impedance (Ω) 1 turn		Impedance (Ω) 2 turn		Applicable cable diameter (mm)
		A	B	C	D	E	25 MHz	100 MHz	25 MHz	100 MHz	
TFC 16813	1	19.8	7.6	18.9	19.8	-	57	115	237	517	Ø7.2 max
TFC 16816	1	19.8	7.6	21.9	19.8	-	73	139	300	597	Ø7.2 max
TFCM 16-8-13	2	19.8	7.6	18.9	22.3	-	57	115	237	517	Ø7.2 max
TFCM 16-8-16	2	19.8	7.6	21.9	22.3	-	73	139	300	597	Ø7.2 max
TFC 20-10-10	3	24.2	8.8	13.5	27.9	19.9	47	92	192	410	Ø8.5 max
TFC 23-11-14	3	27.4	10.8	17.5	31.0	23.9	72	132	301	547	Ø10.5 max
TFC 25-15-12	3	28.2	13.6	13.7	30.9	20.1	41	88	167	390	Ø13.0 max
TFCM 41-27-16	1*	44	26.6	19.6	48.2	-	50	100	-	-	Ø26.0 max
TFP 2014-T	4	20	13.5	7.2	4.8	-	Mounting part with adhesive tape				-
TFP 2014-V	4	20	13.5	7.2	4.8	-	Mounting part for screw Ø3.4mm				-

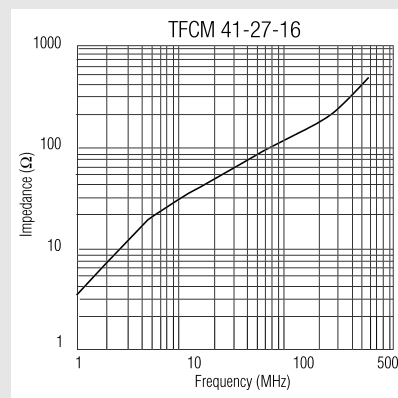
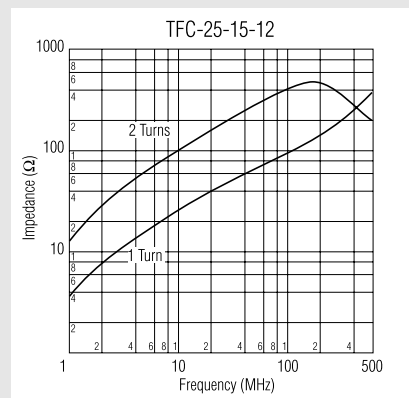
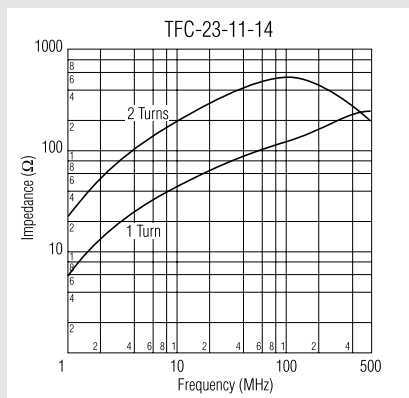
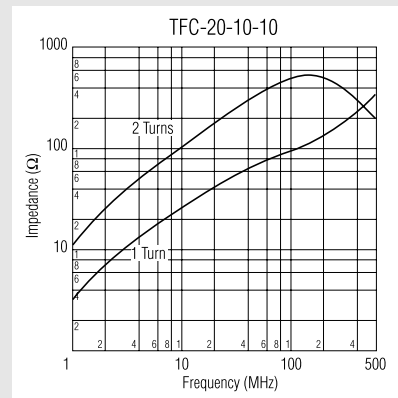
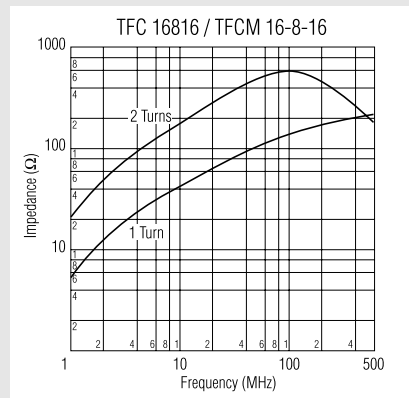
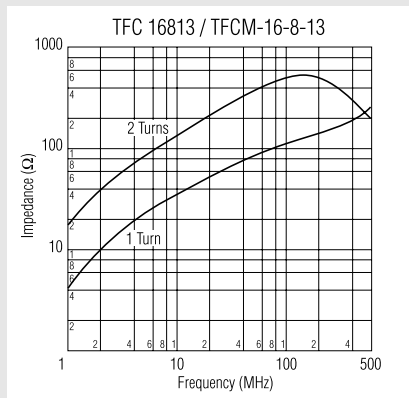

1* Sharpe is slightly different, please ask for drawing.

TFCR series (TFC/TFCM ferrite with re-use clamp) are available.

X-ON Electronics

Largest Supplier of Electrical and Electronic Components

Click to view similar products for [mec switches](#) manufacturer:

Other Similar products are found below :

[95NA3509](#) [1R001](#) [1B00](#) [1630004](#) [1D27F1500](#) [1SS06-08.0](#) [1A02](#) [5GTH9208222](#) [4FTH901](#) [2SS09-07.0](#) [1ZCS53](#) [025773H](#) [1DS11](#)
[5GSH96501](#) [1ZW09](#) [1TS03](#) [1US00](#) [1692108](#) [MSFC-10KEX](#) [2A03](#) [099196G](#) [429981B](#) [1GAS09](#) [1IS16-12.0](#) [10C1616LMH11809](#) [1ZB09](#)
[1Z09](#) [1ZCS30](#) [1630008](#) [1670003](#) [1SS02-09.5](#) [5GSH92022](#) [5GSH96522](#) [1SS06-12.0](#) [1US03](#) [1Q001](#) [15452](#) [5GTH9202242](#) [1D30](#) [1D04](#)
[AQN-2.5](#) [1A09XU134](#) [5GSH920Q](#) [XO-08-7.37280MHZ](#) [099349E](#) [4FSH961](#) [2D032](#) [1630000](#) [1ZB57](#) [AQN-0.5](#)