



Features

- 0.5W CW Output Power at 3.6V
- 1W CW Output Power at 5V
- 32dB Small Signal Gain at 900MHz
- >60% Efficiency @ P_{SAT}
- Digitally Controlled Output Power
- 380MHz to 960MHz Frequency Range
- High Isolation

Applications

- Analog Communication Systems
- 900MHz Spread Spectrum Systems
- 400MHz Industrial Radios
- Driver Stage for Higher Power Applications
- 3V to 5V Applications
- High Isolation Buffer

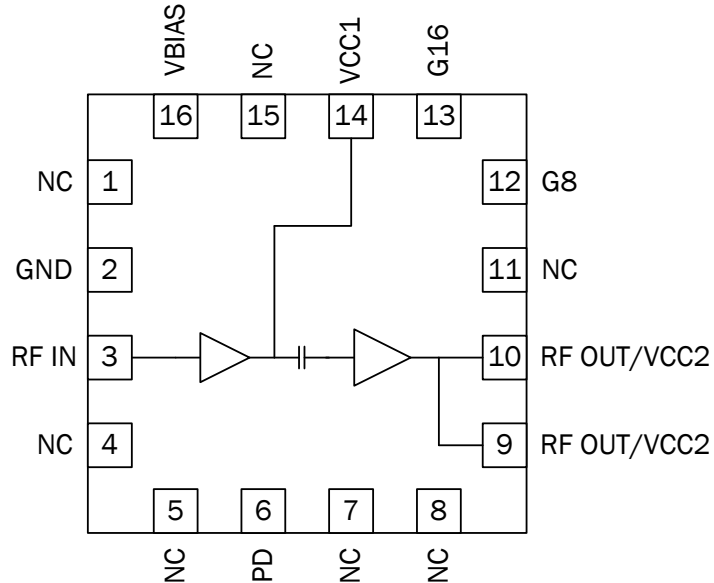

Functional Block Diagram

Product Description

The RFPA0133 is a 3V to 5V high efficiency programmable gain amplifier IC. The device is manufactured on an advanced Gallium Arsenide Hetero-junction Bipolar Transistor (HBT) process. The device has been designed to offer saturated efficiency greater than 60% over a range of frequencies from 380MHz to 960MHz.

Ordering Information

RFPA0133SQ	Sample Bag with 25 Pieces
RFPA0133SR	7" Reel with 100 Pieces
RFPA0133TR7	7" Reel with 2500 Pieces
RFPA0133PCK-410	860MHz to 930MHz PCBA with 5-piece Sample Bag
RFPA0133PCK-411	430MHz to 470MHz PCBA with 5-piece Sample Bag

Optimum Technology Matching® Applied

- | | | | |
|--|--------------------------------------|-------------------------------------|-----------------------------------|
| <input checked="" type="checkbox"/> GaAs HBT | <input type="checkbox"/> SiGe BiCMOS | <input type="checkbox"/> GaAs pHEMT | <input type="checkbox"/> GaN HEMT |
| <input type="checkbox"/> GaAs MESFET | <input type="checkbox"/> Si BiCMOS | <input type="checkbox"/> Si CMOS | <input type="checkbox"/> RF MEMS |
| <input type="checkbox"/> InGaP HBT | <input type="checkbox"/> SiGe HBT | <input type="checkbox"/> Si BJT | <input type="checkbox"/> LDMOS |

Absolute Maximum Ratings

Parameter	Rating	Unit
Supply Voltage	-0.5 to +5.25	V _{DC}
Power Down Voltage (V _{PD})	-0.5 to +3.3	V
V _{BIAS}	-0.5 to +3.3	V
DC Supply Current	500	mA
Input RF Power	+10	dBm
Output Load VSWR (See Note)	6:1	
Ambient Operating Temperature	-40 to +85	°C
Storage Temperature	-40 to +150	°C



Caution! ESD sensitive device.

Exceeding any one or a combination of the Absolute Maximum Rating conditions may cause permanent damage to the device. Extended application of Absolute Maximum Rating conditions to the device may reduce device reliability. Specified typical performance or functional operation of the device under Absolute Maximum Rating conditions is not implied.

RoHS status based on EU Directive 2002/95/EC (at time of this document revision).

The information in this publication is believed to be accurate and reliable. However, no responsibility is assumed by RF Micro Devices, Inc. ("RFMD") for its use, nor for any infringement of patents, or other rights of third parties, resulting from its use. No license is granted by implication or otherwise under any patent or patent rights of RFMD. RFMD reserves the right to change component circuitry, recommended application circuitry and specifications at any time without prior notice.

Note: Due to high efficiency of this PA, the maximum ICC should always be less than 400mA. Only under short term poor VSWR conditions is 500mA acceptable.

Parameter	Specification			Unit	Condition
	Min.	Typ.	Max.		
Overall					T=25 °C, V _{CC} =3.6V, V _{PD} =V _{BIAS} =3.0V, P _{IN} =0dBm, Freq=915MHz
CW Output Power		27.5		dBm	V _{CC} =3.6V
CW Output Power		30		dBm	V _{CC} =5V
Small Signal Gain		32		dB	P _{IN} =-10dBm
Second Harmonic		23		dBc	Without external second harmonic trap
Third Harmonic		45		dBc	
CW Efficiency	55	63		%	G16="high", G8="high", P _{IN} =0dBm
Power Down "ON"		3.0		V	Voltage supplied to the input
Power Down "OFF"	0	0.5	0.8	V	Voltage supplied to the input
VPD Input Current		6		mA	Only in "ON" state
G16, G8 "ON"	1.7		3.0	V	Voltage supplied to the input
G16, G8 "OFF"	0		0.7	V	Voltage supplied to the input
G16, G8 Input Current		1.0		mA	Only in "ON" state
Output Power	26.5	27.5	29	dBm	G16="high", G8="high", P _{IN} =0dBm
	21	23	25	dBm	G16="high", G8="low", P _{IN} =0dBm
	14	16	18	dBm	G16="low", G8="high", P _{IN} =0dBm
	3	5	8	dBm	G16="low", G8="low", P _{IN} =0dBm
Turn On/Off Time		200		ns	
Power Supply					
Power Supply Voltage		3.6		V	Specifications
Power Supply Current		230		mA	G16="high", G8="high", P _{IN} =0dBm
		150		mA	G16="high", G8="low", P _{IN} =0dBm
		65		mA	G16="low", G8="high", P _{IN} =0dBm
		35		mA	G16="low", G8="low", P _{IN} =0dBm
Idle Current	40	75	110	mA	G16="high", G8="high", No RF In
		60	200	nA	G16="low", G8="low", PD="low". No RF IN.

P_{OUT} versus P_{IN}
860MHz to 930MHz at 3.6V and +25°C.

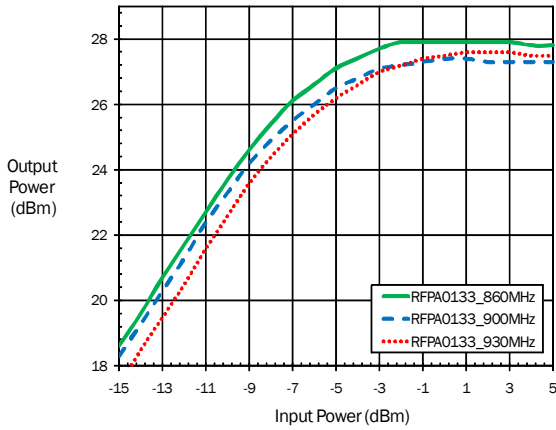

Efficiency versus P_{OUT}
860MHz to 930MHz at 3.6V and +25°C

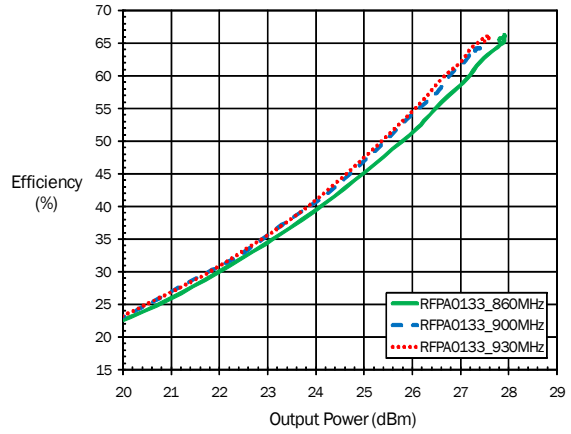

P_{OUT} versus P_{IN}
900MHz at 3.6V; -40°C to +85°C

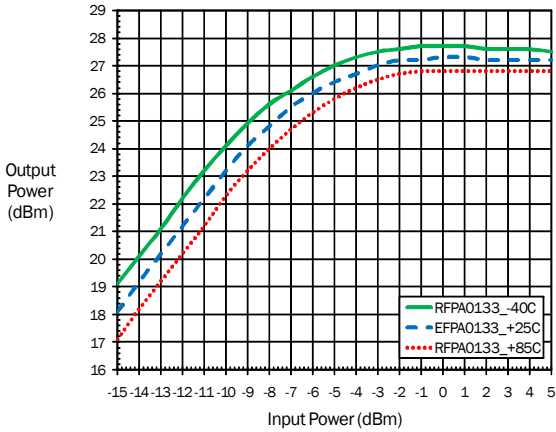

Efficiency versus P_{OUT}
900MHz at 3.6V; -40°C to +85°C

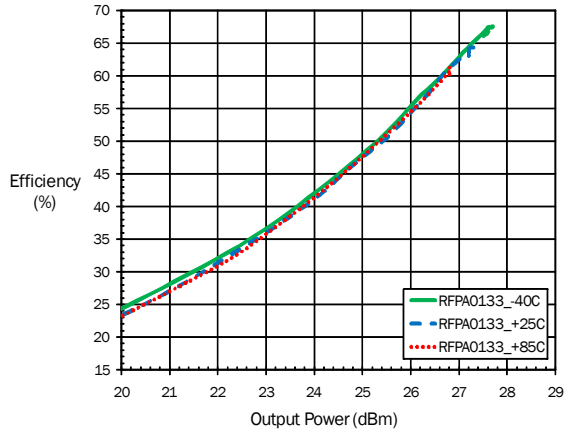

P_{SAT} versus V_{CC}
900 MHz $P_{IN}=0$ dBm

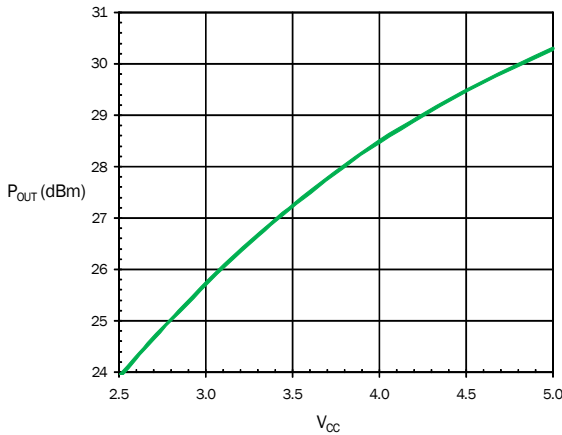

Saturated Efficiency versus V_{CC}
900 MHz $P_{IN}=0$ dBm

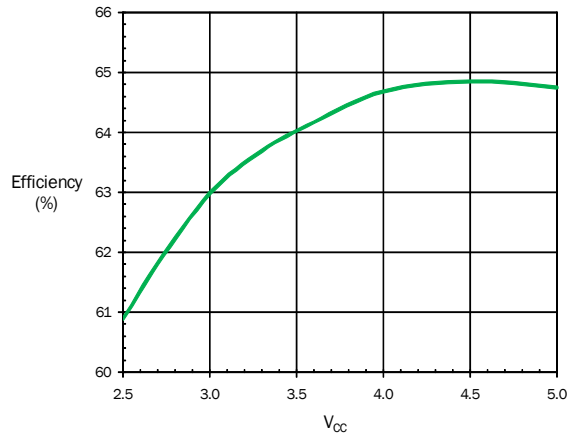

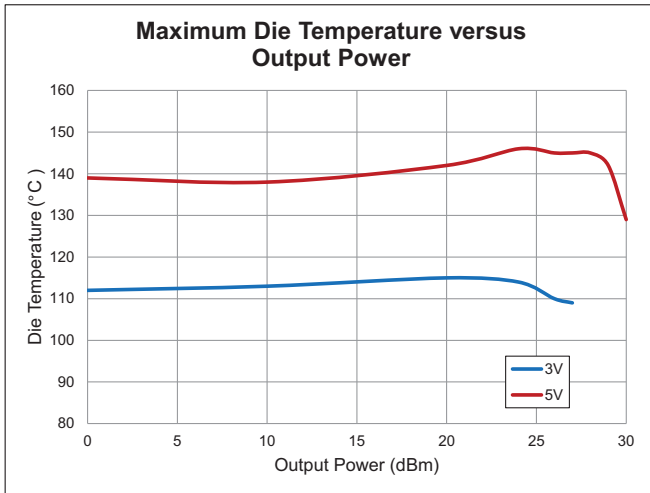
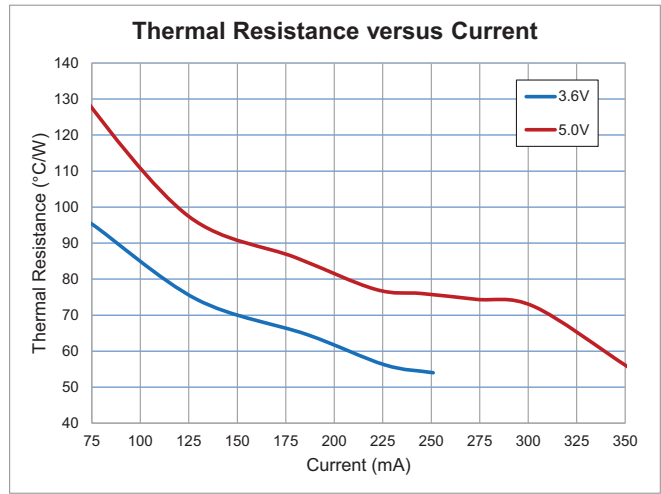
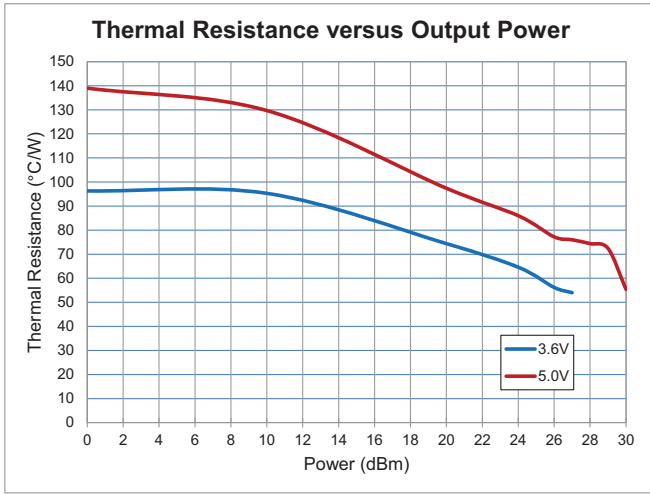

NOTE: Thermal resistance and die temperature are measured at a PCB temperature of 85°C on a standard 900MHz evaluation board.

Pin	Function	Description
1,4,5, 7,8, 11, 15	NC	These pins may be left unconnected or soldered to ground.
2	GND	Ground connection. Keep traces physically short and connect immediately to the ground plane for best performance.
3	RF IN	Amplifier RF input. The amplifier does not contain internal DC blocking and, therefore, should be externally DC blocked before connecting to any device which has DC present or which contains a DC path to ground.
6	VPD	Power down control voltage. When this pin is at 0V, the device will be in power down mode, dissipating minimum DC power. When this pin is at 3V the device will be in full power mode delivering maximum gain and output power capability. This pin should not, in any circumstance, be higher than 3.3V. This pin should also have an external UHF and HF bypassing capacitor. Typically $V_{BIAS}=V_{PD}=3.0V$.
9,10	RF OUT/VCC2	Amplifier RF output. This is an unmatched collector output of the final amplifier transistor. Bias for the final power amplifier output transistor must also be provided through one of these pins. Pins 9 and 10 should be used for the RF output with a matching network that presents the optimum load impedance to the PA for maximum power and efficiency, as well as providing DC blocking at the output.
12	G8	RF output power gain control 8dB bit (see specification table for logic). The control voltage at this pin should never exceed 3.3V and a logic high should be at least 1.7V. This pin should also have an external UHF bypassing capacitor. See note.
13	G16	RF output power gain control 16dB bit (see specification table for logic). The control voltage at this pin should never exceed 3.3V and a logic high should be at least 1.7V. This pin should also have an external UHF bypassing capacitor. See note.
14	VCC1	Positive supply for the first stage (driver) amplifier. This is an unmatched transistor collector output.
16	VBIAS	Positive supply for the bias circuits. This pin should be bypassed with a single UHF capacitor, placed as close as possible to the package. Typically, $V_{BIAS}=V_{PD}=3.0V$.

Note: The 8dB and 16dB gain steps are approximate for small signal operation. As the device compresses, the values of the gain steps compress as well. The output power table on page two shows the effect of the gain steps for saturated (0dBm input) operation.

**Evaluation Board Schematic
430MHz to 470MHz**

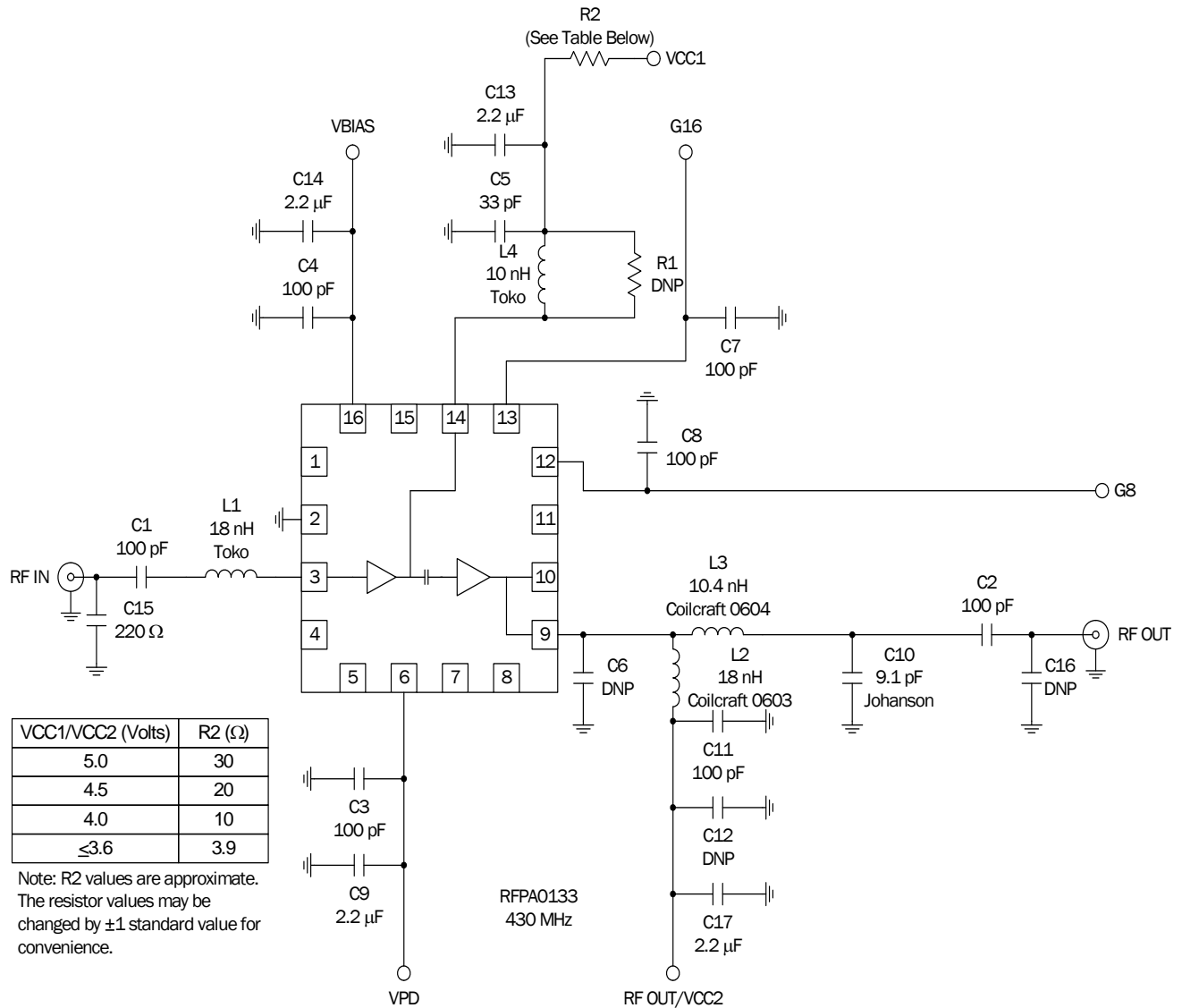

Evaluation Board Layout

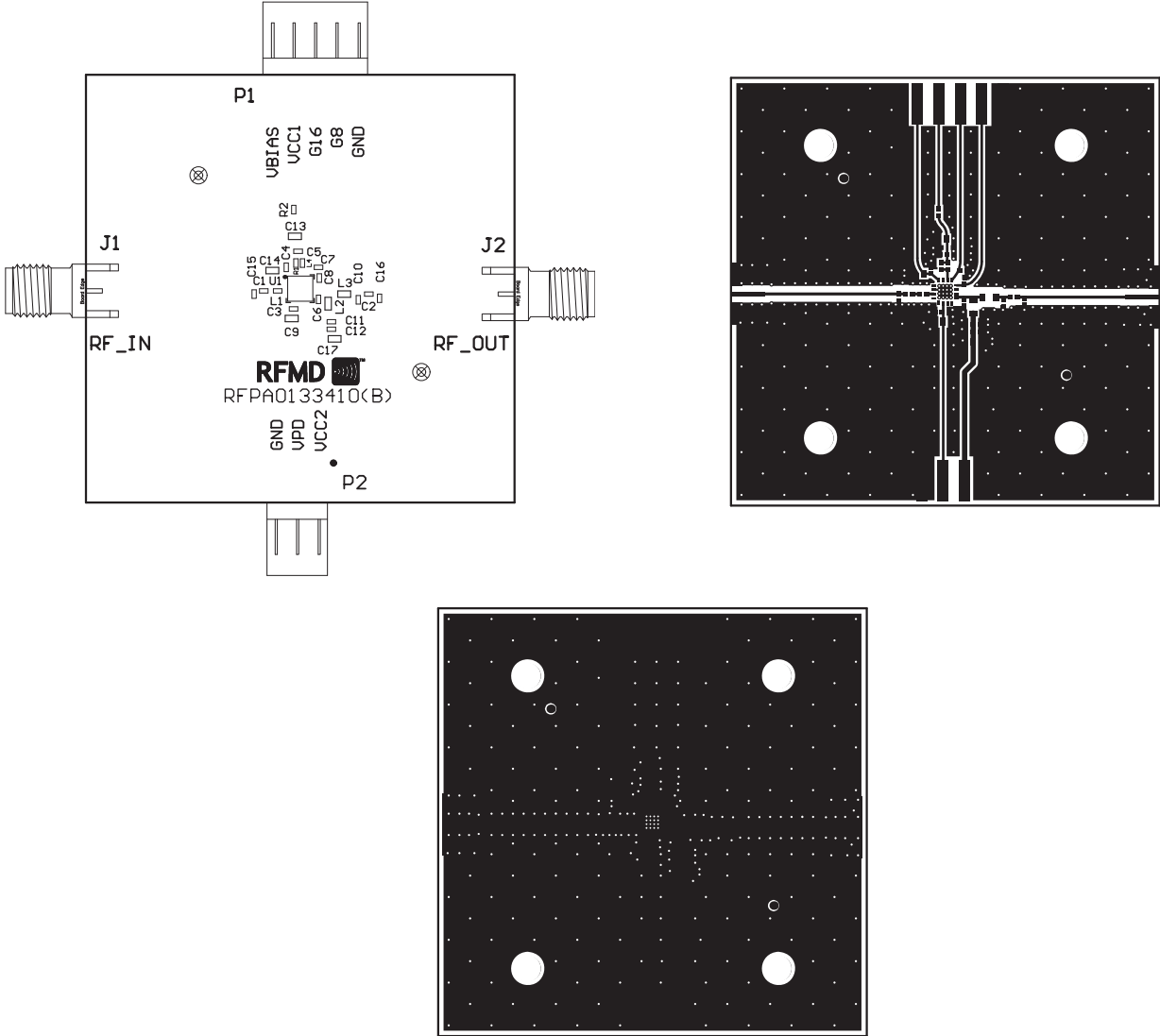

Package Drawing

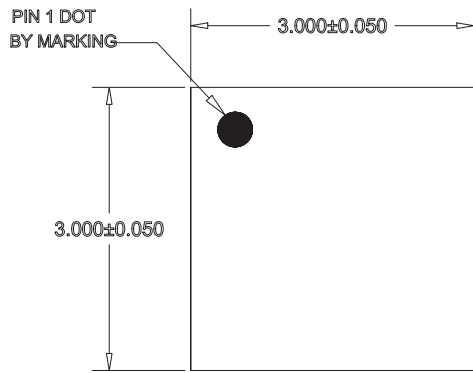

TOP VIEW

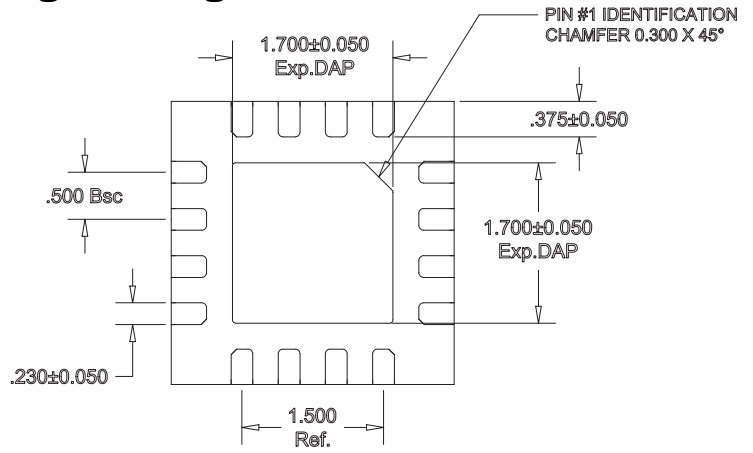

BOTTOM VIEW

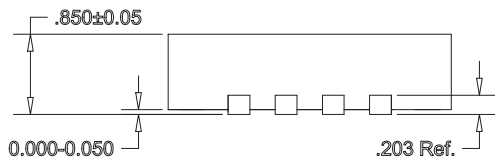

TOP VIEW

Branding Diagram

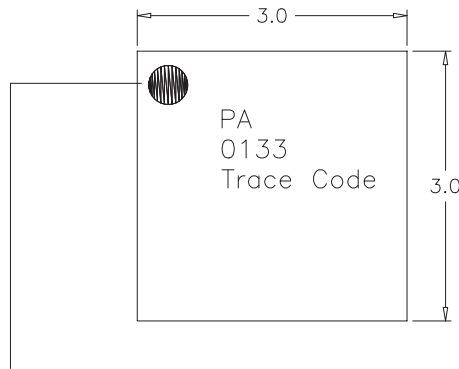

Pin 1 Indicator

Trace Code to be assigned by SubCon

X-ON Electronics

Largest Supplier of Electrical and Electronic Components

Click to view similar products for [rfmd](#) manufacturer:

Other Similar products are found below :

[S10040220GT](#) [S10040180P1](#) [NBB-400-T1](#) [SPF5189Z](#) [NBB-310-T1](#) [SPF5122Z](#) [SPF5043Z](#) [RFSA2033TR7](#)