

Please read this notice before using the TAIYO YUDEN products.

REMINDERS

- Product information in this catalog is as of October 2017. All of the contents specified herein are subject to change without notice due to technical improvements, etc. Therefore, please check for the latest information carefully before practical application or use of our products.

Please note that TAIYO YUDEN shall not be in any way responsible for any damages and defects in products or equipment incorporating our products, which are caused under the conditions other than those specified in this catalog or individual product specification sheets.

- Please contact TAIYO YUDEN for further details of product specifications as the individual product specification sheets are available.
- Please conduct validation and verification of our products in actual condition of mounting and operating environment before using our products.
- The products listed in this catalog are intended for use in general electronic equipment (e.g., AV equipment, OA equipment, home electric appliances, office equipment, information and communication equipment including, without limitation, mobile phone, and PC) and medical equipment classified as Class I or II by IMDRF. Please be sure to contact TAIYO YUDEN for further information before using the products for any equipment which may directly cause loss of human life or bodily injury (e.g., transportation equipment including, without limitation, automotive powertrain control system, train control system, and ship control system, traffic signal equipment, disaster prevention equipment, medical equipment classified as Class III by IMDRF, highly public information network equipment including, without limitation, telephone exchange, and base station).

Please do not incorporate our products into any equipment requiring high levels of safety and/or reliability (e.g., aerospace equipment, aviation equipment*, medical equipment classified as Class IV by IMDRF, nuclear control equipment, undersea equipment, military equipment).

*Note: There is a possibility that our products can be used only for aviation equipment that does not directly affect the safe operation of aircraft (e.g., in-flight entertainment, cabin light, electric seat, cooking equipment) if such use meets requirements specified separately by TAIYO YUDEN. Please be sure to contact TAIYO YUDEN for further information before using our products for such aviation equipment.

When our products are used even for high safety and/or reliability-required devices or circuits of general electronic equipment, it is strongly recommended to perform a thorough safety evaluation prior to use of our products and to install a protection circuit as necessary.

Please note that unless you obtain prior written consent of TAIYO YUDEN, TAIYO YUDEN shall not be in any way responsible for any damages incurred by you or third parties arising from use of the products listed in this catalog for any equipment requiring inquiry to TAIYO YUDEN or prohibited for use by TAIYO YUDEN as described above.

- Information contained in this catalog is intended to convey examples of typical performances and/or applications of our products and is not intended to make any warranty with respect to the intellectual property rights or any other related rights of TAIYO YUDEN or any third parties nor grant any license under such rights.
- Please note that the scope of warranty for our products is limited to the delivered our products themselves and TAIYO YUDEN shall not be in any way responsible for any damages resulting from a fault or defect in our products. Notwithstanding the foregoing, if there is a written agreement (e.g., supply and purchase agreement, quality assurance agreement) signed by TAIYO YUDEN and your company, TAIYO YUDEN will warrant our products in accordance with such agreement.
- The contents of this catalog are applicable to our products which are purchased from our sales offices or authorized distributors (hereinafter "TAIYO YUDEN's official sales channel"). Please note that the contents of this catalog are not applicable to our products purchased from any seller other than TAIYO YUDEN's official sales channel.
- Caution for Export
Some of our products listed in this catalog may require specific procedures for export according to "U.S. Export Administration Regulations", "Foreign Exchange and Foreign Trade Control Law" of Japan, and other applicable regulations. Should you have any questions on this matter, please contact our sales staff.

MULTILAYER CHIP INDUCTORS(LK SERIES)



WAVE* REFLOW

*Except for LK1005

PARTS NUMBER

* Operating Temp.: -40~+85°C

L	K	△	1	6	0	8	△	R	1	0	M	-	T	△
①	②	③	④	⑤	⑥									

△=Blank space

①Series name

Code	Series name
LK△	Multilayer chip inductor

②Dimensions (L × W)

Code	Type (inch)	Dimensions (L × W) [mm]
1005	1005 (0402)	1.0 × 0.5
1608	1608 (0603)	1.6 × 0.8
2125	2125 (0805)	2.0 × 1.25

③Nominal inductance

Code (example)	Nominal inductance [μH]
47N	0.047
R10	0.1
1R0	1.0
100	10

※R=Decimal point

※N=0.0(nH type)

④Inductance tolerance

Code	Inductance tolerance
K	±10%
M	±20%

⑤Packaging

Code	Packaging
-T	Taping

⑥Internal code

Code	Internal code
△	Standard

STANDARD EXTERNAL DIMENSIONS / STANDARD QUANTITY

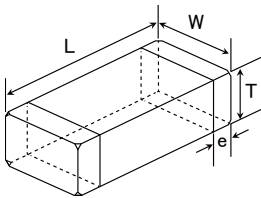

Type	L	W	T	e	Standard quantity [pcs]	
					Paper tape	Embossed tape
LK 1005 (0402)	1.00±0.05 (0.039±0.002)	0.50±0.05 (0.020±0.002)	0.50±0.05 (0.020±0.002)	0.25±0.10 (0.010±0.004)	10000	—
LK 1608 (0603)	1.6±0.15 (0.063±0.006)	0.8±0.15 (0.031±0.006)	0.8±0.15 (0.031±0.006)	0.3±0.2 (0.012±0.008)	4000	—
LK 2125 (0805)	2.0+0.3/-0.1 (0.079+0.012/-0.004)	1.25±0.2 (0.049±0.008)	0.85±0.2 (0.033±0.008)	0.5±0.3 (0.020±0.012)	4000	—
	2.0+0.3/-0.1 (0.079+0.012/-0.004)	1.25±0.2 (0.049±0.008)	1.25±0.2 (0.049±0.008)	0.5±0.3 (0.020±0.012)	—	2000

Unit: mm (inch)

► This catalog contains the typical specification only due to the limitation of space. When you consider the purchase of our products, please check our product specification sheets. For details of each product (characteristics graph, reliability information, precautions for use, and so on), see our website (<http://www.ty-top.com/>).

LK1005

Parts number	EHS	Nominal inductance [μ H]	Inductance tolerance	Q (min.)	Self-resonant frequency [MHz] (min.)	DC Resistance [Ω] (max.)	Rated current [mA] (max.)	Measuring frequency [MHz]	Thickness [mm]
LK 1005 R12-T	RoHS	0.12	$\pm 10\%$, $\pm 20\%$	10	180	0.59	25	25	0.50 ± 0.05
LK 1005 R15-T	RoHS	0.15	$\pm 10\%$, $\pm 20\%$	10	165	0.63	25	25	0.50 ± 0.05
LK 1005 R18-T	RoHS	0.18	$\pm 10\%$, $\pm 20\%$	10	150	0.76	25	25	0.50 ± 0.05
LK 1005 R22-T	RoHS	0.22	$\pm 10\%$, $\pm 20\%$	10	135	0.79	25	25	0.50 ± 0.05
LK 1005 R27-T	RoHS	0.27	$\pm 10\%$, $\pm 20\%$	10	120	0.91	25	25	0.50 ± 0.05
LK 1005 R33-T	RoHS	0.33	$\pm 10\%$, $\pm 20\%$	10	105	1.05	25	25	0.50 ± 0.05
LK 1005 R39-T	RoHS	0.39	$\pm 10\%$, $\pm 20\%$	20	85	0.41	20	10	0.50 ± 0.05
LK 1005 R47-T	RoHS	0.47	$\pm 10\%$, $\pm 20\%$	20	80	0.42	20	10	0.50 ± 0.05
LK 1005 R56-T	RoHS	0.56	$\pm 10\%$, $\pm 20\%$	20	75	0.47	20	10	0.50 ± 0.05
LK 1005 R68-T	RoHS	0.68	$\pm 10\%$, $\pm 20\%$	20	70	0.55	20	10	0.50 ± 0.05
LK 1005 R82-T	RoHS	0.82	$\pm 10\%$, $\pm 20\%$	20	65	0.59	20	10	0.50 ± 0.05
LK 1005 1R0-T	RoHS	1.0	$\pm 10\%$, $\pm 20\%$	20	60	0.64	20	10	0.50 ± 0.05
LK 1005 1R2-T	RoHS	1.2	$\pm 10\%$, $\pm 20\%$	20	55	0.79	20	10	0.50 ± 0.05
LK 1005 1R5-T	RoHS	1.5	$\pm 10\%$, $\pm 20\%$	20	50	0.95	20	10	0.50 ± 0.05
LK 1005 1R8-T	RoHS	1.8	$\pm 10\%$, $\pm 20\%$	20	45	1.16	20	10	0.50 ± 0.05
LK 1005 2R2-T	RoHS	2.2	$\pm 10\%$, $\pm 20\%$	20	40	1.15	20	10	0.50 ± 0.05

※ □ mark indicates the Inductance tolerance code.

LK1608

Parts number	EHS	Nominal inductance [μ H]	Inductance tolerance	Q (min.)	Self-resonant frequency [MHz] (min.)	DC Resistance [Ω] (max.)	Rated current [mA] (max.)	Measuring frequency [MHz]	Thickness [mm]
LK 1608 47NM-T	RoHS	0.047	$\pm 20\%$	10	260	0.20	150	50	0.80 ± 0.15
LK 1608 68NM-T	RoHS	0.068	$\pm 20\%$	10	250	0.30	150	50	0.80 ± 0.15
LK 1608 82NM-T	RoHS	0.082	$\pm 20\%$	10	245	0.30	150	50	0.80 ± 0.15
LK 1608 R10-T	RoHS	0.10	$\pm 10\%$, $\pm 20\%$	15	240	0.35	150	25	0.80 ± 0.15
LK 1608 R12-T	RoHS	0.12	$\pm 10\%$, $\pm 20\%$	15	205	0.40	150	25	0.80 ± 0.15
LK 1608 R15-T	RoHS	0.15	$\pm 10\%$, $\pm 20\%$	15	180	0.45	150	25	0.80 ± 0.15
LK 1608 R18-T	RoHS	0.18	$\pm 10\%$, $\pm 20\%$	15	165	0.50	100	25	0.80 ± 0.15
LK 1608 R22-T	RoHS	0.22	$\pm 10\%$, $\pm 20\%$	15	150	0.55	100	25	0.80 ± 0.15
LK 1608 R27-T	RoHS	0.27	$\pm 10\%$, $\pm 20\%$	15	136	0.80	100	25	0.80 ± 0.15
LK 1608 R33-T	RoHS	0.33	$\pm 10\%$, $\pm 20\%$	15	125	0.75	80	25	0.80 ± 0.15
LK 1608 R39-T	RoHS	0.39	$\pm 10\%$, $\pm 20\%$	15	110	0.85	80	25	0.80 ± 0.15
LK 1608 R47-T	RoHS	0.47	$\pm 10\%$, $\pm 20\%$	15	105	0.95	80	25	0.80 ± 0.15
LK 1608 R56-T	RoHS	0.56	$\pm 10\%$, $\pm 20\%$	15	95	1.05	80	25	0.80 ± 0.15
LK 1608 R68-T	RoHS	0.68	$\pm 10\%$, $\pm 20\%$	15	80	1.25	40	25	0.80 ± 0.15
LK 1608 R82-T	RoHS	0.82	$\pm 10\%$, $\pm 20\%$	15	75	1.40	40	25	0.80 ± 0.15
LK 1608 1R0-T	RoHS	1.0	$\pm 10\%$, $\pm 20\%$	35	70	0.60	40	10	0.80 ± 0.15
LK 1608 1R2-T	RoHS	1.2	$\pm 10\%$, $\pm 20\%$	35	60	0.65	40	10	0.80 ± 0.15
LK 1608 1R5-T	RoHS	1.5	$\pm 10\%$, $\pm 20\%$	35	55	0.70	40	10	0.80 ± 0.15
LK 1608 1R8-T	RoHS	1.8	$\pm 10\%$, $\pm 20\%$	35	50	0.95	40	10	0.80 ± 0.15
LK 1608 2R2-T	RoHS	2.2	$\pm 10\%$, $\pm 20\%$	35	45	1.00	30	10	0.80 ± 0.15
LK 1608 2R7-T	RoHS	2.7	$\pm 10\%$, $\pm 20\%$	35	40	1.15	30	10	0.80 ± 0.15
LK 1608 3R3-T	RoHS	3.3	$\pm 10\%$, $\pm 20\%$	35	38	1.30	30	10	0.80 ± 0.15
LK 1608 3R9-T	RoHS	3.9	$\pm 10\%$, $\pm 20\%$	35	36	1.50	30	10	0.80 ± 0.15
LK 1608 4R7-T	RoHS	4.7	$\pm 10\%$, $\pm 20\%$	35	33	1.60	30	10	0.80 ± 0.15
LK 1608 5R6-T	RoHS	5.6	$\pm 10\%$, $\pm 20\%$	35	22	1.10	10	4	0.80 ± 0.15
LK 1608 6R8-T	RoHS	6.8	$\pm 10\%$, $\pm 20\%$	35	20	1.30	10	4	0.80 ± 0.15
LK 1608 8R2-T	RoHS	8.2	$\pm 10\%$, $\pm 20\%$	35	18	1.50	10	4	0.80 ± 0.15
LK 1608 100-T	RoHS	10	$\pm 10\%$, $\pm 20\%$	35	17	1.70	10	2	0.80 ± 0.15
LK 1608 120-T	RoHS	12	$\pm 10\%$, $\pm 20\%$	35	15	1.80	10	2	0.80 ± 0.15
LK 1608 150M-T	RoHS	15	$\pm 20\%$	20	14	1.50	1	1	0.80 ± 0.15
LK 1608 180M-T	RoHS	18	$\pm 20\%$	20	13	1.60	1	1	0.80 ± 0.15
LK 1608 220M-T	RoHS	22	$\pm 20\%$	20	11	1.70	1	1	0.80 ± 0.15
LK 1608 270M-T	RoHS	27	$\pm 20\%$	20	10	1.80	1	1	0.80 ± 0.15
LK 1608 330M-T	RoHS	33	$\pm 20\%$	20	9	2.20	1	1	0.80 ± 0.15

※ □ mark indicates the Inductance tolerance code.

LK2125

Parts number	EHS	Nominal inductance [μ H]	Inductance tolerance	Q (min.)	Self-resonant frequency [MHz] (min.)	DC Resistance [Ω] (max.)	Rated current [mA] (max.)	Measuring frequency [MHz]	Thickness [mm]
LK 2125 47NM-T	RoHS	0.047	$\pm 20\%$	15	320	0.10	300	50	0.85 ± 0.2
LK 2125 68NM-T	RoHS	0.068	$\pm 20\%$	15	280	0.15	300	50	0.85 ± 0.2
LK 2125 82NM-T	RoHS	0.082	$\pm 20\%$	15	255	0.20	300	50	0.85 ± 0.2
LK 2125 R10-T	RoHS	0.10	$\pm 10\%$, $\pm 20\%$	20	235	0.15	270	25	0.85 ± 0.2
LK 2125 R12-T	RoHS	0.12	$\pm 10\%$, $\pm 20\%$	20	220	0.20	270	25	0.85 ± 0.2
LK 2125 R15-T	RoHS	0.15	$\pm 10\%$, $\pm 20\%$	20	200	0.20	270	25	0.85 ± 0.2
LK 2125 R18-T	RoHS	0.18	$\pm 10\%$, $\pm 20\%$	20	185	0.25	270	25	0.85 ± 0.2
LK 2125 R22-T	RoHS	0.22	$\pm 10\%$, $\pm 20\%$	20	170	0.30	250	25	0.85 ± 0.2
LK 2125 R27-T	RoHS	0.27	$\pm 10\%$, $\pm 20\%$	20	150	0.35	250	25	0.85 ± 0.2
LK 2125 R33-T	RoHS	0.33	$\pm 10\%$, $\pm 20\%$	20	145	0.40	250	25	0.85 ± 0.2
LK 2125 R39-T	RoHS	0.39	$\pm 10\%$, $\pm 20\%$	25	135	0.45	200	25	0.85 ± 0.2
LK 2125 R47-T	RoHS	0.47	$\pm 10\%$, $\pm 20\%$	25	125	0.50	200	25	1.25 ± 0.2
LK 2125 R56-T	RoHS	0.56	$\pm 10\%$, $\pm 20\%$	25	115	0.55	150	25	1.25 ± 0.2
LK 2125 R68-T	RoHS	0.68	$\pm 10\%$, $\pm 20\%$	25	105	0.60	150	25	1.25 ± 0.2
LK 2125 R82-T	RoHS	0.82	$\pm 10\%$, $\pm 20\%$	25	100	0.65	150	25	1.25 ± 0.2
LK 2125 1R0-T	RoHS	1.0	$\pm 10\%$, $\pm 20\%$	45	75	0.30	80	10	0.85 ± 0.2
LK 2125 1R2-T	RoHS	1.2	$\pm 10\%$, $\pm 20\%$	45	65	0.35	80	10	0.85 ± 0.2
LK 2125 1R5-T	RoHS	1.5	$\pm 10\%$, $\pm 20\%$	45	60	0.40	80	10	0.85 ± 0.2
LK 2125 1R8-T	RoHS	1.8	$\pm 10\%$, $\pm 20\%$	45	55	0.45	80	10	0.85 ± 0.2
LK 2125 2R2-T	RoHS	2.2	$\pm 10\%$, $\pm 20\%$	45	50	0.50	50	10	0.85 ± 0.2
LK 2125 2R7-T	RoHS	2.7	$\pm 10\%$, $\pm 20\%$	45	45	0.55	50	10	1.25 ± 0.2
LK 2125 3R3-T	RoHS	3.3	$\pm 10\%$, $\pm 20\%$	45	41	0.60	50	10	1.25 ± 0.2
LK 2125 3R9-T	RoHS	3.9	$\pm 10\%$, $\pm 20\%$	45	38	0.70	30	10	1.25 ± 0.2
LK 2125 4R7-T	RoHS	4.7	$\pm 10\%$, $\pm 20\%$	45	35	0.70	30	10	1.25 ± 0.2
LK 2125 5R6-T	RoHS	5.6	$\pm 10\%$, $\pm 20\%$	50	32	0.60	15	4	1.25 ± 0.2
LK 2125 6R8-T	RoHS	6.8	$\pm 10\%$, $\pm 20\%$	50	29	0.70	15	4	1.25 ± 0.2
LK 2125 8R2-T	RoHS	8.2	$\pm 10\%$, $\pm 20\%$	50	26	0.70	15	4	1.25 ± 0.2
LK 2125 100-T	RoHS	10	$\pm 10\%$, $\pm 20\%$	50	24	0.80	15	2	1.25 ± 0.2
LK 2125 120-T	RoHS	12	$\pm 10\%$, $\pm 20\%$	50	22	0.90	15	2	1.25 ± 0.2
LK 2125 150M-T	RoHS	15	$\pm 20\%$	30	19	0.70	5	1	1.25 ± 0.2
LK 2125 180M-T	RoHS	18	$\pm 20\%$	30	18	0.80	5	1	1.25 ± 0.2
LK 2125 220M-T	RoHS	22	$\pm 20\%$	30	16	0.90	5	1	1.25 ± 0.2
LK 2125 270M-T	RoHS	27	$\pm 20\%$	30	14	1.00	5	1	1.25 ± 0.2
LK 2125 330M-T	RoHS	33	$\pm 20\%$	30	13	1.10	5	0.4	1.25 ± 0.2

※ □ mark indicates the Inductance tolerance code.

Multilayer chip inductors

Multilayer chip inductors for high frequency, Multilayer chip bead inductors

Multilayer common mode choke coils (MC series F type)

Metal Multilayer Chip Power Inductors (MCOIL™ MC series)

■ PACKAGING

① Minimum Quantity

● Tape & Reel Packaging

Type	Thickness mm (inch)	Standard Quantity [pcs]	
		Paper Tape	Embossed Tape
CK1608(0603)	0.8 (0.031)	4000	—
CK2125(0805)	0.85(0.033)	4000	—
	1.25(0.049)	—	2000
CKS2125(0805)	0.85(0.033)	4000	—
	1.25(0.049)	—	2000
CKP1608(0603)	0.8 (0.031)	4000	—
CKP2012(0805)	0.9 (0.035)	—	3000
CKP2016(0806)	0.9 (0.035)	—	3000
CKP2520(1008)	0.7 (0.028)	—	3000
	0.9 (0.035)	—	3000
	1.1 (0.043)	—	2000
NM2012(0805)	0.9 (0.035)	—	3000
NM2520(1008)	0.9 (0.035)	—	3000
	1.1 (0.043)	—	2000
LK1005(0402)	0.5 (0.020)	10000	—
LK1608(0603)	0.8 (0.031)	4000	—
LK2125(0805)	0.85(0.033)	4000	—
	1.25(0.049)	—	2000
HK0603(0201)	0.3 (0.012)	15000	—
HK1005(0402)	0.5 (0.020)	10000	—
HK1608(0603)	0.8 (0.031)	4000	—
HK2125(0805)	0.85(0.033)	—	4000
	1.0 (0.039)	—	3000
HKQ0402(01005)	0.2 (0.008)	20000	40000
HKQ0603W(0201)	0.3 (0.012)	15000	—
HKQ0603S(0201)	0.3 (0.012)	15000	—
HKQ0603U(0201)	0.3 (0.012)	15000	—
AQ105(0402)	0.5 (0.020)	10000	—
BK0402(01005)	0.2 (0.008)	20000	—
BK0603(0201)	0.3 (0.012)	15000	—
BK1005(0402)	0.5 (0.020)	10000	—
BKH0603(0201)	0.3 (0.012)	15000	—
BKH1005(0402)	0.5 (0.020)	10000	—
BK1608(0603)	0.8 (0.031)	4000	—
BK2125(0805)	0.85(0.033)	4000	—
	1.25(0.049)	—	2000
BK2010(0804)	0.45(0.018)	4000	—
BK3216(1206)	0.8 (0.031)	—	4000
BKP0402(01005)	0.2 (0.008)	20000	—
BKP0603(0201)	0.3 (0.012)	15000	—
BKP1005(0402)	0.5 (0.020)	10000	—
BKP1608(0603)	0.8 (0.031)	4000	—
BKP2125(0805)	0.85(0.033)	4000	—
MCF0605(0202)	0.3 (0.012)	15000	—
MCF0806(0302)	0.4 (0.016)	—	10000
MCF1210(0504)	0.55(0.022)	—	5000
MCF2010(0804)	0.45(0.018)	—	4000
MCFK1608(0603)	0.6 (0.024)	4000	—
MCFE1608(0603)	0.65(0.026)	4000	—
MCKK1608(0603)	1.0(0.039)	—	3000
MCHK2012(0806)	0.8 (0.031)	4000	—
MCKK2012(0805)	1.0(0.039)	—	3000

▶ This catalog contains the typical specification only due to the limitation of space. When you consider the purchase of our products, please check our specification. For details of each product (characteristics graph, reliability information, precautions for use, and so on), see our Web site (<http://www.ty-top.com/>).

② Taping material

● Card board carrier tape

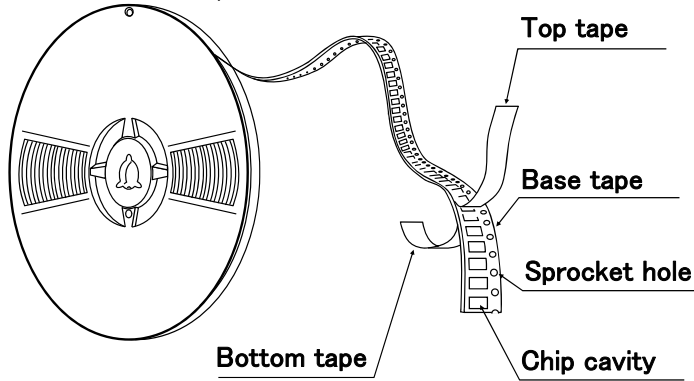

CK	1608
CKP	1608
CK	2125
CKS	2125
LK	1005
LK	1608
LK	2125
HK	0603
HK	1005
HK	1608
HKQ	0402
HKQ	0603
AQ	105

BK	0402
BK	0603
BK	1005
BK	1608
BK	2125
BK	2010
BKP	0402
BKP	0603
BKP	1005
BKP	1608
BKP	2125
BKH	0603
BKH	1005
MCF	0605
MC	1608
MC	2012

Chip Filled

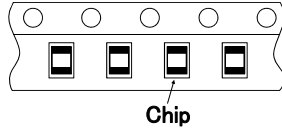

● Embossed Tape

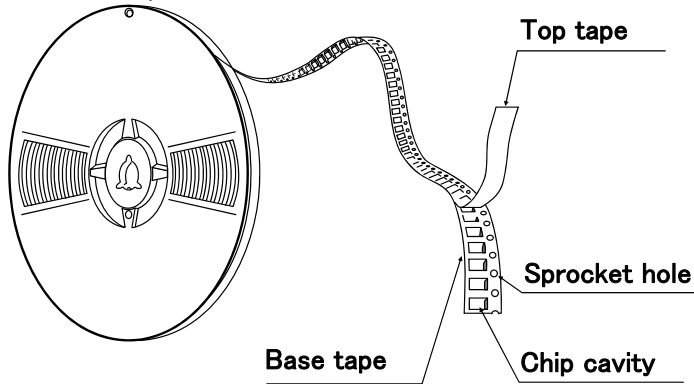

CK	2125
CKS	2125
CKP	2012
CKP	2016
CKP	2520
NM	2012
NM	2520
LK	2125
HKQ	0402
HK	2125

BK	2125
BK	3216
MCF	0806
MCF	1210
MCF	2010
MC	1608
MC	2012

Chip Filled

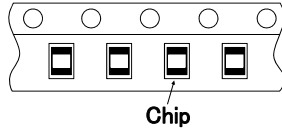

③ Taping Dimensions

● Paper tape (8mm wide)

Unit: mm (inch)

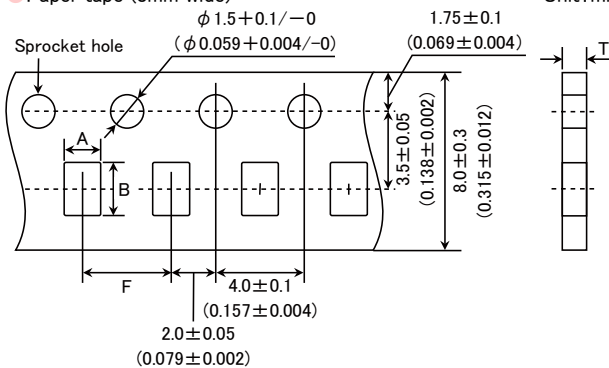

▶ This catalog contains the typical specification only due to the limitation of space. When you consider the purchase of our products, please check our specification. For details of each product (characteristics graph, reliability information, precautions for use, and so on), see our Web site (<http://www.ty-top.com/>).

Type	Thickness mm (inch)	Chip cavity		Insertion Pitch	Tape Thickness
		A	B	F	T
CK1608(0603)	0.8 (0.031)	1.0±0.2 (0.039±0.008)	1.8±0.2 (0.071±0.008)	4.0±0.1 (0.157±0.004)	1.1max (0.043max)
CK2125(0805)	0.85(0.033)	1.5±0.2 (0.059±0.008)	2.3±0.2 (0.091±0.008)	4.0±0.1 (0.157±0.004)	1.1max (0.043max)
CKS2125(0805)	0.85(0.033)	1.5±0.2 (0.059±0.008)	2.3±0.2 (0.091±0.008)	4.0±0.1 (0.157±0.004)	1.1max (0.043max)
CKP1608(0603)	0.8 (0.031)	1.0±0.2 (0.039±0.008)	1.8±0.2 (0.071±0.008)	4.0±0.1 (0.157±0.004)	1.1max (0.043max)
LK1005(0402)	0.5 (0.020)	0.65±0.1 (0.026±0.004)	1.15±0.1 (0.045±0.004)	2.0±0.05 (0.079±0.002)	0.8max (0.031max)
LK1608(0603)	0.8 (0.031)	1.0±0.2 (0.039±0.008)	1.8±0.2 (0.071±0.008)	4.0±0.1 (0.157±0.004)	1.1max (0.043max)
LK2125(0805)	0.85(0.033)	1.5±0.2 (0.059±0.008)	2.3±0.2 (0.091±0.008)	4.0±0.1 (0.157±0.004)	1.1max (0.043max)
HK0603(0201)	0.3 (0.012)	0.40±0.06 (0.016±0.002)	0.70±0.06 (0.028±0.002)	2.0±0.05 (0.079±0.002)	0.45max (0.018max)
HK1005(0402)	0.5 (0.020)	0.65±0.1 (0.026±0.004)	1.15±0.1 (0.045±0.004)	2.0±0.05 (0.079±0.002)	0.8max (0.031max)
HK1608(0603)	0.8 (0.031)	1.0±0.2 (0.039±0.008)	1.8±0.2 (0.071±0.008)	4.0±0.1 (0.157±0.004)	1.1max (0.043max)
HKQ0402(01005)	0.2 (0.008)	0.25±0.04 (0.010±0.002)	0.45±0.04 (0.018±0.002)	2.0±0.05 (0.079±0.002)	0.36max (0.014max)
HKQ0603W(0201)	0.3 (0.012)	0.40±0.06 (0.016±0.002)	0.70±0.06 (0.028±0.002)	2.0±0.05 (0.079±0.002)	0.45max (0.018max)
HKQ0603S(0201)	0.3 (0.012)	0.40±0.06 (0.016±0.002)	0.70±0.06 (0.028±0.002)	2.0±0.05 (0.079±0.002)	0.45max (0.018max)
HKQ0603U(0201)	0.3 (0.012)	0.40±0.06 (0.016±0.002)	0.70±0.06 (0.028±0.002)	2.0±0.05 (0.079±0.002)	0.45max (0.018max)
AQ105(0402)	0.5 (0.020)	0.75±0.1 (0.030±0.004)	1.15±0.1 (0.045±0.004)	2.0±0.05 (0.079±0.002)	0.8max (0.031max)
BK0402(01005)	0.2 (0.008)	0.25±0.04 (0.010±0.002)	0.45±0.04 (0.018±0.002)	2.0±0.05 (0.079±0.002)	0.36max (0.014max)
BK0603(0201)	0.3 (0.012)	0.40±0.06 (0.016±0.002)	0.70±0.06 (0.028±0.002)	2.0±0.05 (0.079±0.002)	0.45max (0.018max)
BK1005(0402)	0.5 (0.020)	0.65±0.1 (0.026±0.004)	1.15±0.1 (0.045±0.004)	2.0±0.05 (0.079±0.002)	0.8max (0.031max)
BK1608(0603)	0.8 (0.031)	1.0±0.2 (0.039±0.008)	1.8±0.2 (0.071±0.008)	4.0±0.1 (0.157±0.004)	1.1max (0.043max)
BK2125(0805)	0.85(0.033)	1.5±0.2 (0.059±0.008)	2.3±0.2 (0.091±0.008)	4.0±0.1 (0.157±0.004)	1.1max (0.043max)
BK2010(0804)	0.45(0.018)	1.2±0.1 (0.047±0.004)	2.17±0.1 (0.085±0.004)	4.0±0.1 (0.157±0.004)	0.8max (0.031max)
BKP0402(01005)	0.2 (0.008)	0.25±0.04 (0.010±0.002)	0.45±0.04 (0.018±0.002)	2.0±0.05 (0.079±0.002)	0.36max (0.014max)
BKP0603(0201)	0.3 (0.012)	0.40±0.06 (0.016±0.002)	0.70±0.06 (0.028±0.002)	2.0±0.05 (0.079±0.002)	0.45max (0.018max)
BKP1005(0402)	0.5 (0.020)	0.65±0.1 (0.026±0.004)	1.15±0.1 (0.045±0.004)	2.0±0.05 (0.079±0.002)	0.8max (0.031max)
BKP1608(0603)	0.8 (0.031)	1.0±0.2 (0.039±0.008)	1.8±0.2 (0.071±0.008)	4.0±0.1 (0.157±0.004)	1.1max (0.043max)
BKP2125(0805)	0.85(0.033)	1.5±0.2 (0.059±0.008)	2.3±0.2 (0.091±0.008)	4.0±0.1 (0.157±0.004)	1.1max (0.043max)
BKH0603(0201)	0.3 (0.012)	0.40±0.06 (0.016±0.002)	0.70±0.06 (0.028±0.002)	2.0±0.05 (0.079±0.002)	0.45max (0.018max)
BKH1005(0402)	0.5 (0.020)	0.65±0.1 (0.026±0.004)	1.15±0.1 (0.045±0.004)	2.0±0.05 (0.079±0.002)	0.8max (0.031max)
MCF0605(0202)	0.3 (0.012)	0.62±0.03 (0.024±0.001)	0.77±0.03 (0.030±0.001)	2.0±0.05 (0.079±0.002)	0.45max (0.018max)
MCFK1608(0603)	0.6 (0.024)	1.1±0.05 (0.043±0.002)	1.9±0.05 (0.075±0.002)	4.0±0.1 (0.157±0.004)	0.72max (0.028max)
MCFE1608(0603)	0.65(0.026)	1.1±0.05 (0.043±0.002)	1.9±0.05 (0.075±0.002)	4.0±0.1 (0.157±0.004)	0.9max (0.035max)
MCHK2012(0805)	0.8 (0.031)	1.55±0.2 (0.061±0.008)	2.3±0.2 (0.091±0.008)	4.0±0.1 (0.157±0.004)	0.9max (0.035max)

Unit : mm (inch)

● Embossed Tape (4mm wide)

Unit : mm (inch)

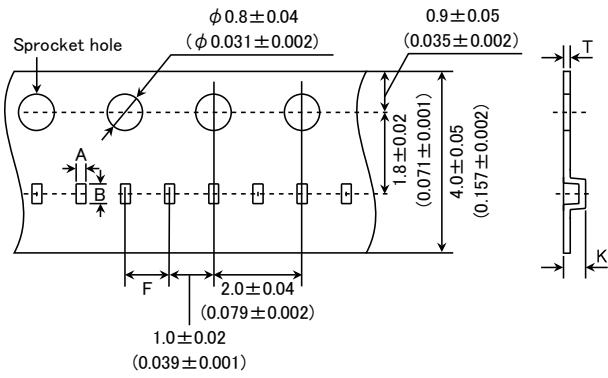

Type	Thickness mm (inch)	Chip cavity		Insertion Pitch F	Tape Thickness	
		A	B		K	T
HKQ0402 (01005)	0.2 (0.008)	0.23	0.43	1.0 ± 0.02	0.5max.	0.25max.

Unit : mm

④ LEADER AND BLANK PORTION

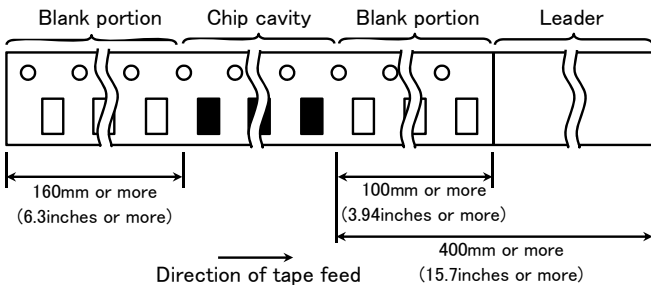

⑤ Reel Size

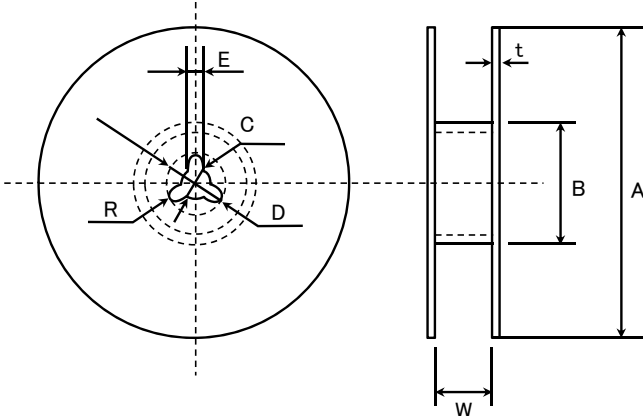

A	B	C	D	E	R
$\phi 178 \pm 2.0$	$\phi 50$ or more	$\phi 13.0 \pm 0.2$	$\phi 21.0 \pm 0.8$	2.0 ± 0.5	1.0

	t	W
4mm width tape	1.5max.	5 ± 1.0
8mm width tape	2.5max.	10 ± 1.5

(Unit : mm)

⑥ Top tape strength

The top tape requires a peel-off force of 0.1~0.7N in the direction of the arrow as illustrated below.

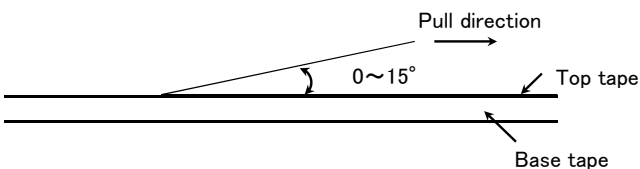

▶ This catalog contains the typical specification only due to the limitation of space. When you consider the purchase of our products, please check our specification. For details of each product (characteristics graph, reliability information, precautions for use, and so on), see our Web site (<http://www.ty-top.com/>).

Multilayer chip inductors

Multilayer chip inductors for high frequency, Multilayer chip bead inductors

Multilayer common mode choke coils (MC series F type)

Metal Multilayer Chip Power Inductors (MCOIL™ MC series)

■ RELIABILITY DATA

1. Operating Temperature Range			
Specified Value	BK0402	-55 ~ +125°C	
	BK0603		
	BK1005		
	BKH0603		
	BKH1005		
	BK1608		
	BK2125		
	ARRAY		BK2010
			BK3216
	BKP0402		-55 ~ +85°C
	BKP0603		
	BKP1005		
	BKP1608		
	BKP2125		
	MCF 0605	-40 ~ +85°C	
	MCF 0806		
	MCF 1210		
	MCF 2010		
	CK1608	-40 ~ +85°C	
	CK2125		
	CKS2125		
	CKP1608		
	CKP2012		
	CKP2016		
	CKP2520		
	NM2012		
	NM2520		
	LK1005		-55 ~ +125°C
	LK1608		
	LK2125		
	HKQ0402	-40 ~ +85°C	
	HK0603		
	HK1005		
	HK1608	-55 ~ +125°C	
HK2125			
HKQ0603W/HKQ0603S/HKQ0603U	-40 ~ +125°C (Including self-generated heat)		
AQ105			
MCFK1608			
MCFE1608			
MCKK1608			
MCHK2012			
MCKK2012			

▶ This catalog contains the typical specification only due to the limitation of space. When you consider the purchase of our products, please check our specification. For details of each product (characteristics graph, reliability information, precautions for use, and so on), see our Web site (<http://www.ty-top.com/>).

2. Storage Temperature Range

Specified Value	BK0402	-55 ~ +125°C	
	BK0603		
	BK1005		
	BKH0603		
	BKH1005		
	BK1608		
	BK2125		
	ARRAY		BK2010
			BK3216
	BKP0402		-55 ~ +85°C
	BKP0603		
	BKP1005		
	BKP1608		
	BKP2125		
	MCF 0605	-40 ~ +85°C	
	MCF 0806		
	MCF 1210		
	MCF 2010		
	CK1608	-40 ~ +85°C	
	CK2125		
	CKS2125		
	CKP1608		
	CKP2012		
	CKP2016		
	CKP2520		
	NM2012		
	NM2520		
	LK1005		
	LK1608		
	LK2125	-55 ~ +125°C	
	HKQ0402		
	HK0603		
HK1005			
HK1608	-40 ~ +85°C		
HK2125	-55 ~ +125°C		
HKQ0603W/HKQ0603S/HKQ0603U			
AQ105	-40 ~ +85°C		
MCFK1608			
MCFE1608			
MCKK1608			
MCHK2012			
MCKK2012			

3. Rated Current

Specified Value	BK0402	150~750mA DC	
	BK0603	100~500mA DC	
	BK1005	120~1000mA DC	
	BKH0603	115~450mA DC	
	BKH1005	200~300mA DC	
	BK1608	150~1500mA DC	
	BK2125	200~1200mA DC	
	ARRAY	BK2010	100mA DC
		BK3216	100~200mA DC
	BKP0402	0.55~1.1A DC	
	BKP0603	0.8~1.8A DC	
	BKP1005	0.8~2.4A DC	
	BKP1608	1.0~3.0A DC	
	BKP2125	1.5~4.0A DC	
	MCF 0605	0.05A DC	
	MCF 0806	0.1~0.13A DC	
	MCF 1210	0.1~0.16A DC	
	MCF 2010	0.1A DC	
	CK1608	50~60mA DC	
	CK2125	60~500mA DC	
	CKS2125	110~280mA DC	
	CKP1608	0.35~0.9A DC	
	CKP2012	0.7~1.7A DC	
	CKP2016	0.9~1.6A DC	
	CKP2520	1.1~1.8A DC	
	NM2012	1.0~1.2A DC	
	NM2520	0.9~1.2A DC	
	LK1005	20~25mA DC	
	LK1608	1~150mA DC	
	LK2125	5~300mA DC	
	HK0603	60~470mA DC	
	HK1005	110~300mA DC (-55~+125°C) 200~900mA DC (-55~+85°C)	
	HK1608	150~300mA DC	
	HK2125	300mA DC	
	HKQ0402	100~500mA DC	
	HKQ0603W	100~850mA DC	
	HKQ0603S	130~600mA DC	
	HKQ0603U	190~900mA DC	
	AQ105	280~710mA DC	
	MCFK1608	Idc1 : 1500~2300mA DC, Idc2 : 900~2100mA DC	
	MCFE1608	Idc1 : 1400~2600mA DC, Idc2 : 800~1500mA DC	
	MCKK1608	Idc1 : 2800~2000mA DC Idc2 : 1300~2600mA DC	
	MCHK2012	Idc1 : 2260~4320mA DC, Idc2 : 1470~3600mA DC	
	MCKK2012	Idc1 : 3600~6200mA DC, Idc2 : 2100~4000mA DC	

Definition of rated current:

- In the CK, CKS and BK Series, the rated current is the value of current at which the temperature of the element is increased within 20°C.
- In the BK Series P type, CK Series P type, NM Series, the rated current is the value of current at which the temperature of the element is increased within 40°C.
- In the LK, HK, HKQ0603, and AQ Series, the rated current is either the DC value at which the initial L value is decreased within 5% with the application of DC bias, or the value of current at which the temperature of the element is increased within 20°C.
- In the HKQ0402(~9N1), the rated current is either the DC value at which the initial L value is decreased within 5% with the application of DC bias, or the value of current at which the temperature of the element is increased within 20°C.
- In the HKQ0402(10N~), the rated current is either the DC value at which the initial L value is decreased within 5% with the application of DC bias, or the value of current at which the temperature of the element is increased within 25°C.
- In the MC Series, Idc1 is the DC value at which the initial L value is decreased within 30% and Idc2 is the DC value at which the temperature of element is increased within 40°C by the application of DC bias. (at 20°C)

4. Impedance			
Specified Value	BK0402	10~330 Ω ±5 Ω(10 Ω), ±25%(Other)	
	BK0603	10~1200 Ω ±25%	
	BK1005	10~1800 Ω ±25%	
	BKH0603	25~1500 Ω ±25%	
	BKH1005	600~1800 Ω ±25%	
	BK1608	22~2500 Ω ±25%	
	BK2125	15~2500 Ω ±25%	
	ARRAY	BK2010	5~1000 Ω ±25%
		BK3216	60~1000 Ω ±25%
	BKP0402	10~33 Ω ±5 Ω(10 Ω), ±25%(Other)	
	BKP0603	10~120 Ω ±5 Ω(10 Ω), ±25%(Other)	
	BKP1005	10~330 Ω ±5 Ω(EM100), ±25%(Other)	
	BKP1608	33~470 Ω ±25%	
	BKP2125	33~330 Ω ±25%	
	MCF 0605	12~90 Ω ±5 Ω(12 Ω), ±20%(35 Ω, 90 Ω), ±25%(60 Ω)	
	MCF 0806	12~90 Ω ±5 Ω(12 Ω), ±20%(47 Ω, 90 Ω), ±25%(30 Ω)	
	MCF 1210	40~90 Ω ±20%(2H900), ±25%(Other)	
	MCF 2010	90 Ω ±25%	
	CK1608		
	CK2125		
	CKS2125		
	CKP1608		
	CKP2012		
	CKP2016		
	CKP2520		
	NM2012		
	NM2520		
	LK1005		
	LK1608		
	LK2125		
	HKQ0402		
	HK0603		
	HK1005		
	HK1608		
	HK2125		
	HKQ0603W/HKQ0603S/HKQ0603U		
	AQ105		
	MCFK1608		
	MCFE1608		
	MCKK1608		
MCHK2012			
MCKK2012			
Test Methods and Remarks	BK0402Series, BKP0402Series		
	Measuring frequency	: 100±1MHz	
	Measuring equipment	: E4991A (or its equivalent)	
	Measuring jig	: 16197A (or its equivalent)	
	BK0603Series, BKP0603Series		
	Measuring frequency	: 100±1MHz	
	Measuring equipment	: 4291A (or its equivalent)	
	Measuring jig	: 16193A (or its equivalent)	
	BK1005Series, BKP1005Series, BKH1005Series		
	Measuring frequency	: 100±1MHz	
	Measuring equipment	: 4291A (or its equivalent)	
	Measuring jig	: 16192A (or its equivalent), 16193A (or its equivalent)	
	BK1608・2125Series, BKP1608・2125Series		
	Measuring frequency	: 100±1MHz	
	Measuring equipment	: 4291A (or its equivalent), 4195A (or its equivalent)	
Measuring jig	: 16092A (or its equivalent) or 16192A (or its equivalent) /HW		
BK2010・3216Series, MCF Series			
Measuring frequency	: 100±1MHz		
Measuring equipment	: 4291A (or its equivalent), 4195A (or its equivalent)		
Measuring jig	: 16192A (or its equivalent)		

▶ This catalog contains the typical specification only due to the limitation of space. When you consider the purchase of our products, please check our specification. For details of each product (characteristics graph, reliability information, precautions for use, and so on), see our Web site (<http://www.ty-top.com/>).

5. Inductance

Specified Value	BK0402	
	BK0603	
	BK1005	
	BKH0603	
	BKH1005	
	BK1608	
	BK2125	
	ARRAY	BK2010
		BK3216
	BKP0402	
	BKP0603	
	BKP1005	
	BKP1608	
	BKP2125	
	MCF 0605	
	MCF 0806	
	MCF 1210	
	MCF 2010	
	CK1608	4.7~10.0 μ H: \pm 20%
	CK2125	0.1~10.0 μ H: \pm 20%
	CKS2125	1.0~10.0 μ H: \pm 20%
	CKP1608	0.33~2.2 μ H: \pm 20%
	CKP2012	0.47~4.7 μ H: \pm 20%
	CKP2016	0.47~4.7 μ H: \pm 20%
	CKP2520	0.47~4.7 μ H: \pm 20%
	NM2012	0.82~1.0 μ H: \pm 20%
	NM2520	1.0~2.2 μ H: \pm 20%
LK1005	0.12~2.2 μ H: \pm 10 or 20%	
LK1608	0.047~33.0 μ H: \pm 20% 0.10~12.0 μ H: \pm 10%	
LK2125	0.047~33.0 μ H: \pm 20% 0.10~12.0 μ H: \pm 10%	
HK0603	1.0~6.2nH: \pm 0.3nH 6.8~100nH: \pm 5%	
HK1005	1.0~6.2nH: \pm 0.3nH 6.8~270nH: \pm 5%	
HK1608	1.0~5.6nH: \pm 0.3nH 6.8~470nH: \pm 5%	
HK2125	1.5~5.6nH: \pm 0.3nH 6.8~470nH: \pm 5%	
HKQ0402	0.5~3.9nH: \pm 0.1 or 0.2 or 0.3nH 4.3~5.6nH: \pm 0.3nH or 3% or 5% 6.2~47nH: \pm 3 or 5%	
HKQ0603W	0.6~3.9nH: \pm 0.1 or 0.2 or 0.3nH 4.3~6.2nH: \pm 0.2 or 0.3nH or 3 or 5% 6.8~30nH: \pm 3 or 5% 33~100nH: \pm 5%	
HKQ0603S	0.6~6.2nH: \pm 0.2 or 0.3nH 6.8~22nH: \pm 3 or 5%	
HKQ0603U	0.6~4.2nH: \pm 0.1 or 0.2 or 0.3nH 4.3~6.5nH: \pm 0.2 or 0.3nH 6.8~22nH: \pm 3 or 5%	
AQ105	1.0~6.2nH: \pm 0.3nH 6.8~15nH: \pm 5%	
MCFK1608	0.24~1.0 μ H: \pm 20%	
MCFE1608	0.24~1.0 μ H: \pm 20%	
MCKK1608	0.24~1.0 μ H: \pm 20%	
MCHK2012	0.24~1.0 μ H: \pm 20%	
MCKK2012	0.24~1.0 μ H: \pm 20%	
Test Methods and Remarks	CK, LK, CKP, NM, MC Series	
	Measuring frequency	: 2~4MHz (CK1608)
	Measuring frequency	: 2~25MHz (CK2125)
	Measuring frequency	: 2~10MHz (CKS2125)
	Measuring frequency	: 10~25MHz (LK1005)
	Measuring frequency	: 1~50MHz (LK1608)
	Measuring frequency	: 0.4~50MHz (LK2125)
	Measuring frequency	: 1MHz (CKP1608·CKP2012·CKP2016·CKP2520·NM2012·NM2520·MCFK1608·MCFE1608·MCHK2012·MCKK2012)
	Measuring equipment /jig	: 4194A + 16085B + 16092A (or its equivalent) 4195A + 41951 + 16092A (or its equivalent) 4294A + 16192A (or its equivalent) 4291A + 16193A (or its equivalent) /LK1005 4285A + 42841A + 42842C + 42851 - 61100 (or its equivalent) /CKP1608·CKP2012·CKP2016·CKP2520·NM2012·NM2520·MCFK1608·MCFE1608·MCKK1608·MCHK2012·MCKK2012
	Measuring current	: 1mA rms (0.047~4.7 μ H) 0.1mA rms (5.6~33 μ H)
	HK, HKQ, AQ Series	
	Measuring frequency	: 100MHz (HK0603·HK1005·AQ105)
	Measuring frequency	: 50/100MHz (HK1608·HK2125)
	Measuring frequency	: 500MHz (HKQ0603S·HKQ0603U)
	Measuring frequency	: 300/500MHz (HKQ0603W)
	Measuring frequency	: 100/500MHz (HKQ0402)
	Measuring equipment /jig	: 4291A + 16197A (or its equivalent) /HK0603·AQ105 4291A + 16193A (or its equivalent) /HK1005 E4991A + 16197A (or its equivalent) /HKQ0603S·HKQ0603U·HKQ0603W 4291A + 16092A + in-house made jig (or its equivalent) /HK1608·HK2125 E4991A + 16196D (or its equivalent) /HKQ0402

Specified Value	BK0402	-	
	BK0603		
	BK1005		
	BKH0603		
	BKH1005		
	BK1608		
	BK2125		
	ARRAY		BK2010
			BK3216
	BKP0402		
	BKP0603		
	BKP1005		
	BKP1608		
	BKP2125		
	MCF 0605		
	MCF 0806		
	MCF 1210		
	MCF 2010		
	CK1608		-
	CK2125		
	CKS2125		
	CKP1608		
	CKP2012		
	CKP2016		
CKP2520			
NM2012			
NM2520			
LK1005	10~20 min.		
LK1608	10~35 min.		
LK2125	15~50 min.		
HK0603	4~5 min.		
HK1005	8 min.		
HK1608	8~12 min.		
HK2125	10~18 min.		
HKQ0402	3~8 min.		
HKQ0603W	6~15 min.		
HKQ0603S	10~13 min.		
HKQ0603U	14 min.		
AQ105	8 min.		
MCFK1608	-		
MCFE1608			
MCKK1608			
MCHK2012			
MCKK2012			
Test Methods and Remarks	LK Series		
	Measuring frequency	: 10~25MHz (LK1005)	
	Measuring frequency	: 1~50MHz (LK1608)	
	Measuring frequency	: 0.4~50MHz (LK2125)	
	Measuring equipment /jig	<ul style="list-style-type: none"> • 4194A + 16085B + 16092A (or its equivalent) • 4195A + 41951 + 16092A (or its equivalent) • 4294A + 16192A (or its equivalent) • 4291A + 16193A (or its equivalent) /LK1005 	
	Measuring current	<ul style="list-style-type: none"> • 1mA rms (0.047~4.7 μH) • 0.1mA rms (5.6~33 μH) 	
	HK, HKQ, AQ Series		
	Measuring frequency	: 100MHz (HK0603・HK1005・AQ105)	
	Measuring frequency	: 50/100MHz (HK1608・HK2125)	
	Measuring frequency	: 500MHz (HKQ0603S・HKQ0603U)	
	Measuring frequency	: 300/500MHz (HKQ0603W)	
	Measuring frequency	: 100/500MHz (HKQ0402)	
Measuring equipment /jig	<ul style="list-style-type: none"> • 4291A + 16197A (or its equivalent) /HK0603・AQ105 • 4291A + 16193A (or its equivalent) /HK1005 • E4991A + 16197A (or its equivalent) /HKQ0603S・HKQ0603U・HKQ0603W • 4291A + 16092A + in-house made jig (or its equivalent) /HK1608, HK2125 • E4991A + 16196D (or its equivalent) HKQ0402 		

7. DC Resistance

Specified Value	BK0402	0.07~1.2 Ω max.	
	BK0603	0.065~1.50 Ω max.	
	BK1005	0.03~0.90 Ω max.	
	BKH0603	0.26~3.20 Ω max.	
	BKH1005	0.85~2.00 Ω max.	
	BK1608	0.05~1.10 Ω max.	
	BK2125	0.05~0.75 Ω max.	
	ARRAY	BK2010	0.10~0.90 Ω max.
		BK3216	0.15~0.80 Ω max.
	BKP0402	0.05~0.15 Ω max.	
	BKP0603	0.030~0.180 Ω max.	
	BKP1005	0.0273~0.220 Ω max.	
	BKP1608	0.025~0.18 Ω max.	
	BKP2125	0.020~0.075 Ω max.	
	MCF 0605	2.5~5.0 Ω max	
	MCF 0806	1.5~5.0 Ω max.	
	MCF 1210	1.5~4.5 Ω max.	
	MCF 2010	4.5 Ω max.	
	CK1608	0.45~0.85 Ω(±30%)	
	CK2125	0.16~0.65 Ω max.	
	CKS2125	0.12~0.52 Ω max.	
	CKP1608	0.15~0.35 Ω max.	
	CKP2012	0.08~0.28 Ω max.	
	CKP2016	0.075~0.20 Ω max	
	CKP2520	0.05~0.16 Ω max.	
	NM2012	0.10~0.15 Ω max.	
	NM2520	0.11~0.22 Ω max.	
	LK1005	0.41~1.16 Ω max.	
	LK1608	0.2~2.2 Ω max.	
	LK2125	0.1~1.1 Ω max.	
	HK0603	0.11~3.74 Ω max.	
	HK1005	0.08~4.8 Ω max.	
	HK1608	0.05~2.6 Ω max.	
	HK2125	0.10~1.5 Ω max.	
	HKQ0402	0.08~5.0 Ω max.	
	HKQ0603W	0.07~4.1 Ω max.	
	HKQ0603S	0.06~1.29 Ω max.	
	HKQ0603U	0.06~1.29 Ω max.	
	AQ105	0.07~0.45 Ω max.	
	MCFK1608	0.050~0.224 Ω max.	
	MCFE1608	0.100~0.340 Ω max.	
	MCKK1608	0.038~0.123 Ω max.	
	MCHK2012	0.024~0.111 Ω max.	
MCKK2012	0.025~0.090 Ω max.		
Test Methods and Remarks	Measuring equipment: VOAC-7412, VOAC-7512, VOAC-7521 (made by Iwasaki Tsushinki), HIOKI3227 (or its equivalent)		

8. Self Resonance Frequency (SRF)

Specified Value	BK0402	
	BK0603	
	BK1005	
	BKH0603	
	BKH1005	
	BK1608	
	BK2125	
	ARRAY	BK2010
		BK3216
	BKP0402	—
	BKP0603	
	BKP1005	
	BKP1608	
	BKP2125	
	MCF 0605	
	MCF 0806	
	MCF 1210	
	MCF 2010	
	CK1608	17~25MHz min.
	CK2125	24~235MHz min.
	CKS2125	24~75MHz min.
	CKP1608	
	CKP2012	
	CKP2016	—
	CKP2520	
	NM2012	
	NM2520	
	LK1005	40~180MHz min.
	LK1608	9~260MHz min.
	LK2125	13~320MHz min.
	HK0603	900~10000MHz min.
	HK1005	400~10000MHz min.
	HK1608	300~10000MHz min.
	HK2125	200~4000MHz min.
HKQ0402	1200~10000MHz min.	
HKQ0603W	800~10000MHz min.	
HKQ0603S	1900~10000MHz min.	
HKQ0603U	1900~10000MHz min.	
AQ105	2300~10000MHz min.	
MCFK1608		
MCFE1608		
MCKK1608	—	
MCHK2012		
MCKK2012		
Test Methods and Remarks	LK, CK Series : Measuring equipment : 4195A (or its equivalent) Measuring jig : 41951 + 16092A (or its equivalent) HK, HKQ, AQ Series : Measuring equipment : 8719C (or its equivalent) • 8753D (or its equivalent) / HK2125	

9. Temperature Characteristic

Specified Value	BK0402	-	
	BK0603		
	BK1005		
	BKH0603		
	BKH1005		
	BK1608		
	BK2125		
	ARRAY		BK2010
			BK3216
	BKP0402		
	BKP0603		
	BKP1005		
	BKP1608		
	BKP2125		
	MCF 0605		
	MCF 0806		
	MCF 1210		
	MCF 2010		
	CK1608		
	CK2125		
	CKS2125		
	CKP1608		
	CKP2012		
	CKP2016		
	CKP2520		
	NM2012		
	NM2520		
	LK1005		
	LK1608		
	LK2125		
	HK0603		Inductance change: Within $\pm 10\%$
	HK1005		
	HK1608		
	HK2125		
HKQ0402			
HKQ0603W			
HKQ0603S			
HKQ0603U			
AQ105			
MCFK1608			
MCFE1608			
MCKK1608			
MCHK2012			
MCKK2012			
Test Methods and Remarks	HK, HKQ, AQ Series: Temperature range : $-30 \sim +85^{\circ}\text{C}$ Reference temperature : $+20^{\circ}\text{C}$ MC Series: Temperature range : $-40 \sim +85^{\circ}\text{C}$ Reference temperature : $+20^{\circ}\text{C}$		

10. Resistance to Flexure of Substrate

Specified Value	BK0402	No mechanical damage.	
	BK0603		
	BK1005		
	BKH0603		
	BKH1005		
	BK1608		
	BK2125		
	ARRAY		BK2010
			BK3216
	BKP0402		
	BKP0603		
	BKP1005		
	BKP1608		
	BKP2125		
	MCF 0605		
	MCF 0806		
	MCF 1210		
	MCF 2010		
	CK1608		
	CK2125		
	CKS2125		
	CKP1608		
	CKP2012		
	CKP2016		
	CKP2520		
	NM2012		
	NM2520		
	LK1005		
	LK1608		
	LK2125		
	HK0603		
	HK1005		
	HK1608		
	HK2125		
	HKQ0402		
	HKQ0603W		
	HKQ0603S		
	HKQ0603U		
	AQ105		
	MCFK1608		
	MCFE1608		
	MCKK1608		
	MCHK2012		
MCKK2012			
Test Methods and Remarks	<p>Warp : 2mm (BK Series without 0402size, BKP, BKH1005, CK, CKS, CKP, LK, HK, HKQ0603S, HKQ0603U, AQ Series, MCF1210, MC Series)</p> <p> : 1mm (BK0402, BKP0402, BKH0603, HKQ0402, HKQ0603W, MCF Series without 1210 size,)</p> <p>Testing board : glass epoxy-resin substrate</p> <p>Thickness : 0.8mm</p>	<p>(Unit: mm)</p>	

► This catalog contains the typical specification only due to the limitation of space. When you consider the purchase of our products, please check our specification. For details of each product (characteristics graph, reliability information, precautions for use, and so on), see our Web site (<http://www.ty-top.com/>).

11. Solderability

Specified Value	BK0402	At least 90% of terminal electrode is covered by new solder.	
	BK0603		
	BK1005		
	BKH0603		
	BKH1005		
	BK1608		
	BK2125		
	ARRAY		BK2010
			BK3216
	BKP0402		
	BKP0603		
	BKP1005		
	BKP1608		
	BKP2125		
	MCF 0605		
	MCF 0806		
	MCF 1210		
	MCF 2010		
	CK1608		
	CK2125		
	CKS2125		
	CKP1608		
	CKP2012		
	CKP2016		
	CKP2520		
	NM2012		
	NM2520		
	LK1005		
	LK1608		
	LK2125		
	HK0603		
	HK1005		
	HK1608		
	HK2125		
	HKQ0402		
	HKQ0603W		
	HKQ0603S		
	HKQ0603U		
	AQ105		
	MCFK1608		
MCFE1608			
MCKK1608			
MCHK2012			
MCKK2012			
Test Methods and Remarks	Solder temperature : 230±5°C (JIS Z 3282 H60A or H63A)		
	Solder temperature : 245±3°C (Sn/3.0Ag/0.5Cu)		
	Duration : 4±1 sec.		

► This catalog contains the typical specification only due to the limitation of space. When you consider the purchase of our products, please check our specification.
 For details of each product (characteristics graph, reliability information, precautions for use, and so on), see our Web site (<http://www.ty-top.com/>).

12. Resistance to Soldering

Specified Value	BK0402	Appearance: No significant abnormality Impedance change: Within $\pm 30\%$	
	BK0603		
	BK1005		
	BKH0603		
	BKH1005		
	BK1608		
	BK2125		
	ARRAY		BK2010
			BK3216
	BKP0402		
	BKP0603		
	BKP1005		
	BKP1608		
	BKP2125		
	MCF 0605	Appearance: No significant abnormality Impedance change: Within $\pm 20\%$	
	MCF 0806		
	MCF 1210		
	MCF 2010		
	CK1608	Appearance: No significant abnormality Inductance change R10~4R7: Within $\pm 10\%$ 6R8~100: Within $\pm 15\%$ CKS2125 : Within $\pm 20\%$ CKP1608, CKP2012, CKP2016, CKP2520, NM2012, NM2520: Within $\pm 30\%$	
	CK2125		
	CKS2125		
	CKP1608		
	CKP2012		
	CKP2016		
	CKP2520		
	NM2012		
	NM2520		
LK1005	Appearance: No significant abnormality Inductance change: Within $\pm 15\%$		
LK1608	Appearance: No significant abnormality Inductance change		
LK2125	47N~4R7: Within $\pm 10\%$ 5R6~330: Within $\pm 15\%$		
HK0603	Appearance: No significant abnormality Inductance change: Within $\pm 5\%$		
HK1005			
HK1608			
HK2125			
HKQ0402			
HKQ0603W			
HKQ0603S			
HKQ0603U			
AQ105			
MCFK1608			
MCFE1608	Appearance: No significant abnormality Inductance change: Within $\pm 10\%$		
MCKK1608			
MCHK2012			
MCKK2012			
Test Methods and Remarks	Solder temperature : $260 \pm 5^\circ\text{C}$ Duration : 10 ± 0.5 sec. Preheating temperature : 150 to 180°C Preheating time : 3 min. Flux : Immersion into methanol solution with colophony for 3 to 5 sec. Recovery : 2 to 3 hrs of recovery under the standard condition after the test. (See Note 1)		

(Note 1) When there are questions concerning measurement result; measurement shall be made after 48 ± 2 hrs of recovery under the standard condition.

13. Thermal Shock

Specified Value	BK0402	Appearance: No significant abnormality Impedance change: Within $\pm 30\%$	
	BK0603		
	BK1005		
	BKH0603		
	BKH1005		
	BK1608		
	BK2125		
	ARRAY		BK2010
			BK3216
	BKP0402		
	BKP0603		
	BKP1005		
	BKP1608		
	BKP2125		
	MCF 0605		Appearance: No significant abnormality Impedance change: Within $\pm 20\%$
	MCF 0806		
	MCF 1210		
	MCF 2010		
	CK1608	Appearance: No significant abnormality Inductance change: Within $\pm 20\%$ Q change: Within $\pm 30\%$	
	CK2125		
	CKS2125	Appearance: No significant abnormality Inductance change: Within $\pm 20\%$	
	CKP1608		
	CKP2012	Appearance: No significant abnormality Inductance change: Within $\pm 30\%$	
	CKP2016		
	CKP2520		
	NM2012		
	NM2520		
	LK1005	Appearance: No significant abnormality Inductance change: Within $\pm 10\%$ Q change: Within $\pm 30\%$	
	LK1608		
	LK2125		
	HK0603	Appearance: No significant abnormality Inductance change: Within $\pm 10\%$ Q change: Within $\pm 20\%$	
	HK1005		
	HK1608		
	HK2125		
	HKQ0402		
	HKQ0603W		
	HKQ0603S		
	HKQ0603U		
	AQ105		
	MCFK1608		
	MCFE1608	Appearance: No significant abnormality Inductance change: Within $\pm 10\%$	
	MCKK1608		
	MCHK2012		
MCKK2012			
Test Methods and Remarks	Conditions for 1 cycle		
	Step	temperature (°C)	time (min.)
	1	Minimum operating temperature +0/−3	30±3
	2	Room temperature	2~3
	3	Maximum operating temperature +3/−0	30±3
4	Room temperature	2~3	
	Number of cycles: 5		
	Recovery: 2 to 3 hrs of recovery under the standard condition after the test. (See Note 1)		
	(Note 1) When there are questions concerning measurement result; measurement shall be made after 48±2 hrs of recovery under the standard condition.		

14. Damp Heat (Steady state)			
Specified Value	BK0402	Appearance: No significant abnormality Impedance change: Within $\pm 30\%$	
	BK0603		
	BK1005		
	BKH0603		
	BKH1005		
	BK1608		
	BK2125		
	ARRAY		BK2010
			BK3216
	BKP0402		
	BKP0603		
	BKP1005		
	BKP1608		
	BKP2125		
	MCF 0605		Appearance: No significant abnormality Impedance change: Within $\pm 20\%$
	MCF 0806		
	MCF 1210		
	MCF 2010		
	CK1608	Appearance: No significant abnormality Inductance change: Within $\pm 20\%$ Q change: Within $\pm 30\%$	
	CK2125		
	CKS2125	Appearance: No significant abnormality Inductance change: Within $\pm 20\%$	
	CKP1608		
	CKP2012	Appearance: No significant abnormality Inductance change: Within $\pm 30\%$	
	CKP2016		
	CKP2520		
	NM2012		
	NM2520		
	LK1005	Appearance: No significant abnormality Inductance change: Within $\pm 10\%$ Q change: Within $\pm 30\%$	
	LK1608		
	LK2125	Appearance: No significant abnormality Inductance change: Within $\pm 20\%$ Q change: Within $\pm 30\%$	
	HK0603		
	HK1005	Appearance: No significant abnormality Inductance change: Within $\pm 10\%$ Q change: Within $\pm 20\%$	
	HK1608		
HK2125			
HKQ0402			
HKQ0603W			
HKQ0603S			
HKQ0603U			
AQ105			
MCFK1608			
MCFE1608	Appearance: No significant abnormality Inductance change: Within $\pm 10\%$		
MCKK1608			
MCHK2012			
MCKK2012			
Test Methods and Remarks	BK, BKP, BKH, LK, CK, CKS, CKP, NM Series, MCF Series: Temperature : $40 \pm 2^\circ\text{C}$ Humidity : 90 to 95%RH Duration : 500 +24/-0 hrs Recovery : 2 to 3 hrs of recovery under the standard condition after the removal from test chamber. (See Note 1)		
	HK, HKQ, AQ, MC Series: Temperature : $60 \pm 2^\circ\text{C}$ Humidity : 90 to 95%RH Duration : 500 +24/-0 hrs Recovery : 2 to 3 hrs of recovery under the standard condition after the removal from test chamber. (See Note 1)		

(Note 1) When there are questions concerning measurement result; measurement shall be made after 48 ± 2 hrs of recovery under the standard condition.

15. Loading under Damp Heat

Specified Value	BK0402	Appearance: No significant abnormality Impedance change: Within $\pm 30\%$	
	BK0603		
	BK1005		
	BKH0603		
	BKH1005		
	BK1608		
	BK2125		
	ARRAY		BK2010
			BK3216
	BKP0402		
	BKP0603		
	BKP1005		
	BKP1608		
	BKP2125		
	CK1608		Appearance: No significant abnormality
	CK2125	Inductance change: Within $\pm 20\%$ Q change: Within $\pm 30\%$	
	CKS2125	Appearance: No significant abnormality Inductance change: Within $\pm 20\%$	
	CKP1608	Appearance: No significant abnormality Inductance change: Within $\pm 30\%$	
	CKP2012		
	CKP2016		
	CKP2520		
	NM2012		
	NM2520		
	LK1005	Appearance: No significant abnormality Inductance change: Within $\pm 10\%$ Q change: Within $\pm 30\%$	
	LK1608	Appearance: No significant abnormality Inductance change: 0.047~12.0 μH : Within $\pm 10\%$ 15.0~33.0 μH : Within $\pm 15\%$ Q change: Within $\pm 30\%$	
	LK2125	Appearance: No significant abnormality Inductance change: Within $\pm 20\%$ Q change: Within $\pm 30\%$	
	HK0603	Appearance: No significant abnormality Inductance change: Within $\pm 10\%$ Q change: Within $\pm 20\%$	
	HK1005		
	HK1608		
	HK2125		
HKQ0402			
HKQ0603W			
HKQ0603S			
HKQ0603U			
AQ105			
MCFK1608※	Appearance: No significant abnormality Inductance change: Within $\pm 10\%$		
MCFE1608※			
MCKK1608※			
MCHK2012※			
MCKK2012※			

Test Methods and Remarks	<p>BK, BKP, BKH, LK, CK, CKS, CKP, NM Series:</p> <p>Temperature : $40 \pm 2^\circ\text{C}$ Humidity : 90 to 95%RH Applied current : Rated current Duration : 500 +24/-0 hrs Recovery : 2 to 3 hrs of recovery under the standard condition after the removal from test chamber. (See Note 1)</p>
	<p>HK, HKQ, AQ, MC Series:</p> <p>Temperature : $60 \pm 2^\circ\text{C}$ Humidity : 90 to 95%RH Applied current : Rated current ※MC series ; I_{dc2max} Duration : 500 +24/-0 hrs Recovery : 2 to 3 hrs of recovery under the standard condition after the removal from test chamber. (See Note 1)</p>

Note on standard condition: "standard condition" referred to herein is defined as follows:
5 to 35°C of temperature, 45 to 85% relative humidity, and 86 to 106kPa of air pressure.
When there are questions concerning measurement results:
In order to provide correlation data, the test shall be conducted under condition of $20 \pm 2^\circ\text{C}$ of temperature, 60 to 70% relative humidity, and 86 to 106kPa of air pressure.
Unless otherwise specified, all the tests are conducted under the "standard condition."
(Note 1) Measurement shall be made after 48 ± 2 hrs of recovery under the standard condition.

16. Loading at High Temperature

Specified Value	BK0402	Appearance: No significant abnormality Impedance change: Within $\pm 30\%$	
	BK0603		
	BK1005		
	BKH0603		
	BKH1005		
	BK1608		
	BK2125		
	ARRAY		BK2010
			BK3216
	BKP0402		
	BKP0603		
	BKP1005		
	BKP1608		
	BKP2125		
	MCF 0605		
	MCF 0806		
	MCF 1210		
	MCF 2010		
	CK1608	Appearance: No significant abnormality Inductance change: Within $\pm 20\%$ Q change: Within $\pm 30\%$	
	CK2125		
	CKS2125	Appearance: No significant abnormality Inductance change: Within $\pm 20\%$	
	CKP1608		
	CKP2012	Appearance: No significant abnormality Inductance change: Within $\pm 30\%$	
	CKP2016		
	CKP2520		
	NM2012		
	NM2520		
	LK1005	Appearance: No significant abnormality Inductance change: Within $\pm 10\%$ Q change: Within $\pm 30\%$	
	LK1608		
	LK2125	Appearance: No significant abnormality Inductance change: Within $\pm 20\%$ Q change: Within $\pm 30\%$	
	HK0603		
	HK1005		
	HK1608		
HK2125			
HKQ0402			
HKQ0603W	Appearance: No significant abnormality Inductance change: Within $\pm 10\%$ Q change: Within $\pm 20\%$		
HKQ0603S			
HKQ0603U			
AQ105			
MCFK1608※			
MCFE1608※		Appearance: No significant abnormality Inductance change: Within $\pm 10\%$	
MCKK1608※			
MCHK2012※			
MCKK2012※			
Test Methods and Remarks		Temperature : Maximum operating temperature Applied current : Rated current ※MC series ; I _{dc2max} Duration : 500 +24/-0 hrs Recovery : 2 to 3 hrs of recovery under the standard condition after the removal from test chamber. (See Note 1)	

Note on standard condition: "standard condition" referred to herein is defined as follows:

5 to 35°C of temperature, 45 to 85% relative humidity, and 86 to 106kPa of air pressure.

When there are questions concerning measurement results:

In order to provide correlation data, the test shall be conducted under condition of 20 \pm 2°C of temperature, 60 to 70% relative humidity, and 86 to 106kPa of air pressure. Unless otherwise specified, all the tests are conducted under the "standard condition."

(Note 1) Measurement shall be made after 48 \pm 2 hrs of recovery under the standard condition.

Precautions on the use of Multilayer chip inductors

Multilayer chip inductors for high frequency, Multilayer chip bead inductors

Multilayer common mode choke coils (MC series F type)

Metal Multilayer Chip Power Inductors (MCOIL™ MC series)

■ PRECAUTIONS

1. Circuit Design

Precautions	<ul style="list-style-type: none"> ◆ Verification of operating environment, electrical rating and performance <ol style="list-style-type: none"> 1. A malfunction in medical equipment, spacecraft, nuclear reactors, etc. may cause serious harm to human life or have severe social ramifications. <p>As such, any inductors to be used in such equipment may require higher safety and/or reliability considerations and should be clearly differentiated from components used in general purpose applications.</p> ◆ Operating Current (Verification of Rated current) <ol style="list-style-type: none"> 1. The operating current including inrush current for inductors must always be lower than their rated values. 2. Do not apply current in excess of the rated value because the inductance may be reduced due to the magnetic saturation effect.
-------------	--

2. PCB Design

Precautions	<ul style="list-style-type: none"> ◆ Pattern configurations (Design of Land-patterns) <ol style="list-style-type: none"> 1. When inductors are mounted on a PCB, the size of land patterns and the amount of solder used (size of fillet) can directly affect inductor performance. <p>Therefore, the following items must be carefully considered in the design of solder land patterns:</p> <ol style="list-style-type: none"> (1) The amount of solder applied can affect the ability of chips to withstand mechanical stresses which may lead to breaking or cracking. Therefore, when designing land-patterns it is necessary to consider the appropriate size and configuration of the solder pads which in turn determines the amount of solder necessary to form the fillets. (2) When more than one part is jointly soldered onto the same land or pad, the pad must be designed so that each component's soldering point is separated by solder-resist. (3) The larger size of land patterns and amount of solder, the smaller Q value after mounting on PCB. It makes higher the Q value to design land patterns smaller than terminal electrode of chips. ◆ Pattern configurations (Inductor layout on panelized [breakaway] PC boards) <ol style="list-style-type: none"> 1. After inductors have been mounted on the boards, chips can be subjected to mechanical stresses in subsequent manufacturing processes (PCB cutting, board inspection, mounting of additional parts, assembly into the chassis, wave soldering the reflow soldered boards etc.) For this reason, planning pattern configurations and the position of SMD inductors should be carefully performed to minimize stress.
-------------	---

Technical considerations	<ul style="list-style-type: none"> ◆ Pattern configurations (Design of Land-patterns) <ol style="list-style-type: none"> 1. The following diagrams and tables show some examples of recommended patterns to prevent excessive solder amounts (larger fillets which extend above the component end terminations). Examples of improper pattern designs are also shown. (1) Recommended land dimensions for a typical chip inductor land patterns for PCBs
--------------------------	--

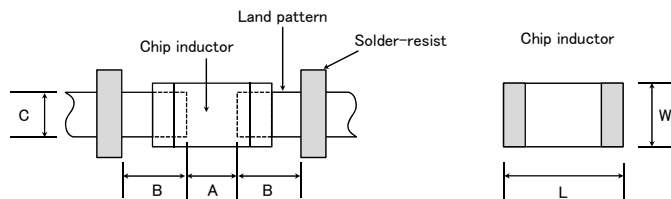

Recommended land dimensions for wave-soldering (Unit: mm)

Type	1608	2012	2125	2016	2520	3216	
Size	L	1.6	2.0	2.0	2.0	2.5	3.2
	W	0.8	1.25	1.25	1.6	2.0	1.6
A	0.8~1.0	1.0~1.4	1.0~1.4	1.0~1.4	1.0~1.4	1.8~2.5	
B	0.5~0.8	0.8~1.5	0.8~1.5	0.8~1.5	0.6~1.0	0.8~1.7	
C	0.6~0.8	0.9~1.2	0.9~1.2	1.3~1.6	1.6~2.0	1.2~1.6	

Recommended land dimensions for reflow-soldering (Unit: mm)

Type	0402	0603	1005	105	1608	2012	2125	2016	2520	3216
Size	L	0.4	0.6	1.0	1.0	1.6	2.0	2.0	2.5	3.2
	W	0.2	0.3	0.5	0.6	0.8	1.25	1.25	1.6	2.0
A	0.15~0.25	0.20~0.30	0.45~0.55	0.50~0.55	0.8~1.0	0.8~1.2	0.8~1.2	0.8~1.2	1.0~1.4	1.8~2.5
B	0.10~0.20	0.20~0.30	0.40~0.50	0.30~0.40	0.6~0.8	0.8~1.2	0.8~1.2	0.8~1.2	0.6~1.0	0.6~1.5
C	0.15~0.30	0.25~0.40	0.45~0.55	0.60~0.70	0.6~0.8	0.9~1.6	0.9~1.6	1.2~2.0	1.8~2.2	1.2~2.0

▶ This catalog contains the typical specification only due to the limitation of space. When you consider the purchase of our products, please check our specification. For details of each product (characteristics graph, reliability information, precautions for use, and so on), see our Web site (<http://www.ty-top.com/>).

Excess solder can affect the ability of chips to withstand mechanical stresses. Therefore, please take proper precautions when designing land-patterns.

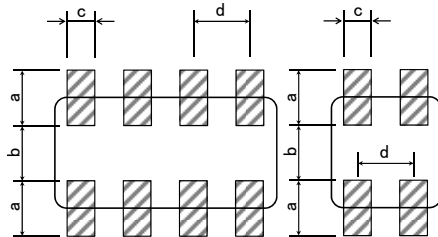

Recommended land dimension for Reflow-soldering

Type		3216	2010	1210	0806	0605
Size	L	3.2	2.0	1.25	0.85	0.65
	W	1.6	1.0	1.0	0.65	0.50
a		0.7~0.9	0.5~0.6	0.45~0.55	0.25~0.35	0.27~0.33
b		0.8~1.0	0.5~0.6	0.7~0.8	0.25~0.35	0.17~0.23
c		0.4~0.5	0.2~0.3	0.25~0.35	0.25~0.35	0.20~0.26
d		0.8	0.5	0.55	0.5	0.4

(Unit: mm)

(2) Examples of good and bad solder application

Item	Not recommended	Recommended
Mixed mounting of SMD and leaded components		
Component placement close to the chassis		
Hand-soldering of leaded components near mounted components		
Horizontal component placement		

◆ Pattern configurations (Inductor layout on panelized [breakaway] PC boards)

1-1. The following are examples of good and bad inductor layout; SMD inductors should be located to minimize any possible mechanical stresses from board warp or deflection.

Item	Not recommended	Recommended
Deflection of the board		 Position the component at a right angle to the direction of the mechanical stresses that are anticipated.

1-2. To layout the inductors for the breakaway PC board, it should be noted that the amount of mechanical stresses given will vary depending on inductor layout.

An example below should be counted for better design.

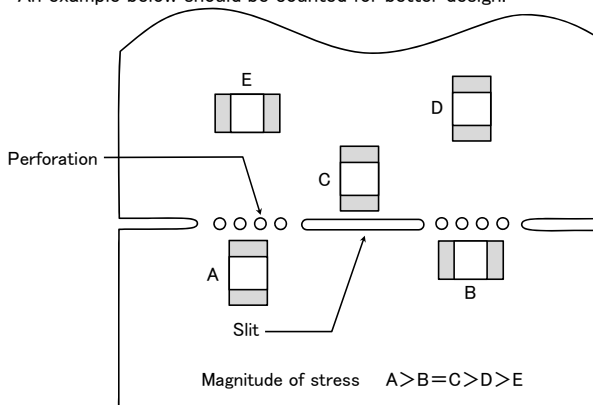

1-3. When breaking PC boards along their perforations, the amount of mechanical stress on the inductors can vary according to the method used. The following methods are listed in order from least stressful to most stressful: push-back, slit, V-grooving, and perforation. Thus, any ideal SMD inductor layout must also consider the PCB splitting procedure.

3. Considerations for automatic placement

Precautions

- ◆ Adjustment of mounting machine
 1. Excessive impact load should not be imposed on the inductors when mounting onto the PC boards.
 2. The maintenance and inspection of the mounter should be conducted periodically.
- ◆ Selection of Adhesives
 1. Mounting inductors with adhesives in preliminary assembly, before the soldering stage, may lead to degraded inductor characteristics unless the following factors are appropriately checked; the size of land patterns, type of adhesive, amount applied, hardening temperature and hardening period. Therefore, it is imperative to consult the manufacturer of the adhesives on proper usage and amounts of adhesive to use.

Technical considerations

- ◆ Adjustment of mounting machine
 1. If the lower limit of the pick-up nozzle is low, too much force may be imposed on the inductors, causing damage. To avoid this, the following points should be considered before lowering the pick-up nozzle:
 - (1) The lower limit of the pick-up nozzle should be adjusted to the surface level of the PC board after correcting for deflection of the board.
 - (2) The pick-up pressure should be adjusted between 1 and 3N static loads.
 - (3) To reduce the amount of deflection of the board caused by impact of the pick-up nozzle, supporting pins or back-up pins should be used under the PC board. The following diagrams show some typical examples of good pick-up nozzle placement:

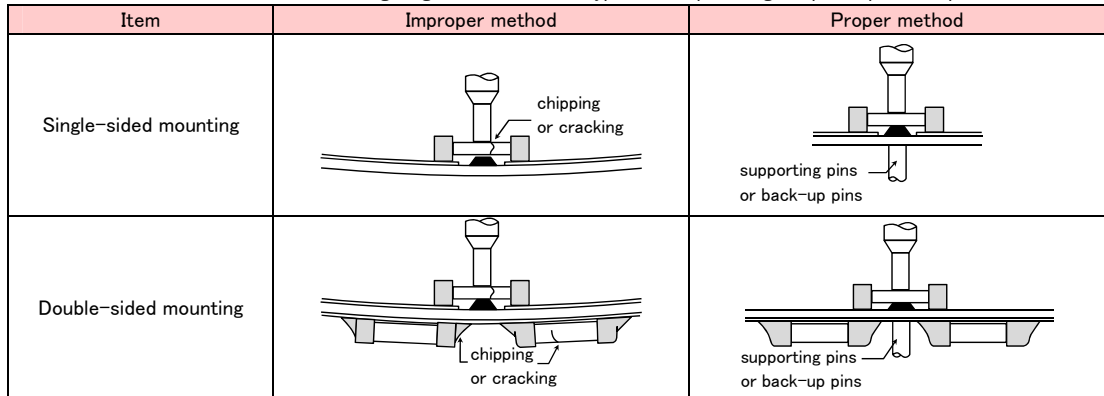

2. As the alignment pin wears out, adjustment of the nozzle height can cause chipping or cracking of the inductors because of mechanical impact on the inductors. To avoid this, the monitoring of the width between the alignment pin in the stopped position, and maintenance, inspection and replacement of the pin should be conducted periodically.
- ◆ Selection of Adhesives
 1. Some adhesives may cause reduced insulation resistance. The difference between the shrinkage percentage of the adhesive and that of the inductors may result in stresses on the inductors and lead to cracking. Moreover, too little or too much adhesive applied to the board may adversely affect component placement, so the following precautions should be noted in the application of adhesives.
 - (1) Required adhesive characteristics
 - a. The adhesive should be strong enough to hold parts on the board during the mounting & solder process.
 - b. The adhesive should have sufficient strength at high temperatures.
 - c. The adhesive should have good coating and thickness consistency.
 - d. The adhesive should be used during its prescribed shelf life.
 - e. The adhesive should harden rapidly.
 - f. The adhesive must not be contaminated.
 - g. The adhesive should have excellent insulation characteristics.
 - h. The adhesive should not be toxic and have no emission of toxic gasses.
 - (2) When using adhesives to mount inductors on a PCB, inappropriate amounts of adhesive on the board may adversely affect component placement. Too little adhesive may cause the inductors to fall off the board during the solder process. Too much adhesive may cause defective soldering due excessive flow of adhesive on to the land or solder pad.

[Recommended conditions]

Figure	0805 case sizes as examples
a	0.3mm min
b	100~120 μ m
c	Area with no adhesive

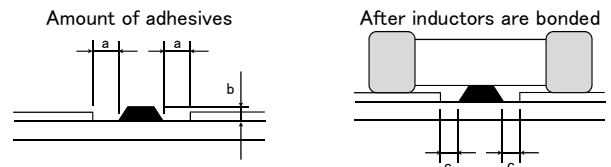

4. Soldering

Precautions

- ◆ Selection of Flux
 1. Since flux may have a significant effect on the performance of inductors, it is necessary to verify the following conditions prior to use;
 - (1) Flux used should be with less than or equal to 0.1 wt% (Chlorine conversion method) of halogenated content. Flux having a strong acidity content should not be applied.
 - (2) When soldering inductors on the board, the amount of flux applied should be controlled at the optimum level.
 - (3) When using water-soluble flux, special care should be taken to properly clean the boards.
- ◆ Soldering
 1. Temperature, time, amount of solder, etc. are specified in accordance with the following recommended conditions, and please contact us about peak temperature when you use lead-free paste.

▶ This catalog contains the typical specification only due to the limitation of space. When you consider the purchase of our products, please check our specification. For details of each product (characteristics graph, reliability information, precautions for use, and so on), see our Web site (<http://www.ty-top.com/>).

◆ Selection of Flux

- 1-1. When too much halogenated substance (Chlorine, etc.) content is used to activate the flux, or highly acidic flux is used, an excessive amount of residue after soldering may lead to corrosion of the terminal electrodes or degradation of insulation resistance on the surface of the Inductor.
- 1-2. Flux is used to increase solderability in flow soldering, but if too much is applied, a large amount of flux gas may be emitted and may detrimentally affect solderability. To minimize the amount of flux applied, it is recommended to use a flux-bubbling system.
- 1-3. Since the residue of water-soluble flux is easily dissolved by water content in the air, the residue on the surface of Inductor in high humidity conditions may cause a degradation of insulation resistance and therefore affect the reliability of the components. The cleaning methods and the capability of the machines used should also be considered carefully when selecting water-soluble flux.

◆ Soldering

1-1. Preheating when soldering

Heating: Chip inductor components should be preheated to within 100 to 130°C of the soldering. Cooling: The temperature difference between the components and cleaning process should not be greater than 100°C.

Chip inductors are susceptible to thermal shock when exposed to rapid or concentrated heating or rapid cooling. Therefore, the soldering process must be conducted with a great care so as to prevent malfunction of the components due to excessive thermal shock.

[Reflow soldering]

【Recommended conditions for eutectic soldering】

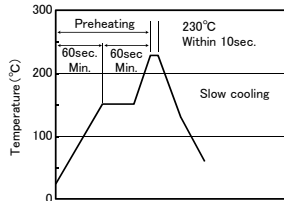

【Recommended condition for Pb-free soldering】

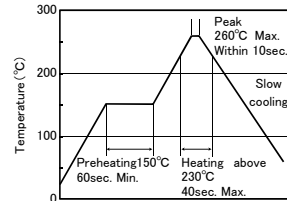

- ※Ceramic chip components should be preheated to within 100 to 130°C of the soldering.
- ※Assured to be reflow soldering for 2 times.
- ※MC series; Peak 230°C (eutectic soldering), 260°C (Pb-free soldering) max within 5sec.

Caution

1. The ideal condition is to have solder mass (fillet) controlled to 1/2 to 1/3 of the thickness of the inductor, as shown below:

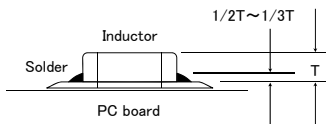

2. Because excessive dwell times can detrimentally affect solderability, soldering duration should be kept as close to recommended times as possible.

[Wave soldering]

【Recommended conditions for eutectic soldering】

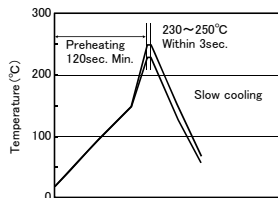

【Recommended condition for Pb-free soldering】

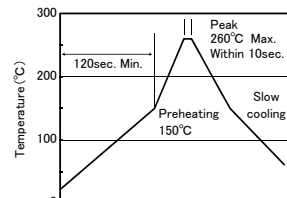

- ※Ceramic chip components should be preheated to within 100 to 130°C of the soldering.
- ※Assured to be wave soldering for 1 time.
- ※Except for reflow soldering type.

Caution

1. Make sure the inductors are preheated sufficiently.
2. The temperature difference between the inductor and melted solder should not be greater than 100 to 130°C.
3. Cooling after soldering should be as gradual as possible.
4. Wave soldering must not be applied to the inductors designated as for reflow soldering only.

[Hand soldering]

【Recommended conditions for eutectic soldering】

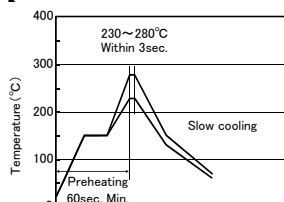

【Recommended condition for Pb-free soldering】

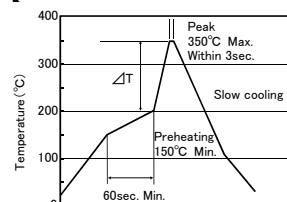

- (※ΔT ≤ 190°C (3216 Type max), ΔT ≤ 130°C (3225 Type min))
- ※It is recommended to use 20W soldering iron and the tip is 1φ or less.
- ※The soldering iron should not directly touch the components.
- ※Assured to be soldering iron for 1 time.
- Note: The above profiles are the maximum allowable soldering condition, therefore these profiles are not always recommended.

Technical considerations

	<p>Caution</p> <ol style="list-style-type: none"> 1. Use a 20W soldering iron with a maximum tip diameter of 1.0 mm. 2. The soldering iron should not directly touch the inductor. 						
5. Cleaning							
Precautions	<p>◆Cleaning conditions</p> <ol style="list-style-type: none"> 1. When cleaning the PC board after the Inductors are all mounted, select the appropriate cleaning solution according to the type of flux used and purpose of the cleaning (e.g. to remove soldering flux or other materials from the production process.) 2. Cleaning conditions should be determined after verifying, through a test run, that the cleaning process does not affect the inductor's characteristics. 						
Technical considerations	<p>◆Cleaning conditions</p> <ol style="list-style-type: none"> 1. The use of inappropriate solutions can cause foreign substances such as flux residue to adhere to the inductor, resulting in a degradation of the inductor's electrical properties (especially insulation resistance). 2. Inappropriate cleaning conditions (insufficient or excessive cleaning) may detrimentally affect the performance of the inductors. <ol style="list-style-type: none"> (1) Excessive cleaning <ol style="list-style-type: none"> a. In the case of ultrasonic cleaning, too much power output can cause excessive vibration of the PC board which may lead to the cracking of the inductor or the soldered portion, or decrease the terminal electrodes' strength. Thus the following conditions should be carefully checked; <table border="0" style="margin-left: 20px;"> <tr> <td>Ultrasonic output</td> <td>Below 20W/ℓ</td> </tr> <tr> <td>Ultrasonic frequency</td> <td>Below 40kHz</td> </tr> <tr> <td>Ultrasonic washing period</td> <td>5 min. or less</td> </tr> </table> 	Ultrasonic output	Below 20W/ℓ	Ultrasonic frequency	Below 40kHz	Ultrasonic washing period	5 min. or less
Ultrasonic output	Below 20W/ℓ						
Ultrasonic frequency	Below 40kHz						
Ultrasonic washing period	5 min. or less						
6. Post cleaning processes							
Precautions	<p>◆Application of resin coatings, moldings, etc. to the PCB and components.</p> <ol style="list-style-type: none"> 1. With some type of resins a decomposition gas or chemical reaction vapor may remain inside the resin during the hardening period or while left under normal storage conditions resulting in the deterioration of the inductor's performance. 2. When a resin's hardening temperature is higher than the inductor's operating temperature, the stresses generated by the excess heat may lead to inductor damage or destruction. 3. Stress caused by a resin's temperature generated expansion and contraction may damage inductors. <p>The use of such resins, molding materials etc. is not recommended.</p>						
7. Handling							
Precautions	<p>◆Breakaway PC boards (splitting along perforations)</p> <ol style="list-style-type: none"> 1. When splitting the PC board after mounting inductors and other components, care is required so as not to give any stresses of deflection or twisting to the board. 2. Board separation should not be done manually, but by using the appropriate devices. <p>◆General handling precautions</p> <ol style="list-style-type: none"> 1. Always wear static control bands to protect against ESD. 2. Keep the inductors away from all magnets and magnetic objects. 3. Use non-magnetic tweezers when handling inductors. 4. Any devices used with the inductors (soldering irons, measuring instruments) should be properly grounded. 5. Keep bare hands and metal products (i.e., metal desk) away from chip electrodes or conductive areas that lead to chip electrodes. 6. Keep inductors away from items that generate magnetic fields such as speakers or coils. <p>◆Mechanical considerations</p> <ol style="list-style-type: none"> 1. Be careful not to subject the inductors to excessive mechanical shocks. <ol style="list-style-type: none"> (1) If inductors are dropped on the floor or a hard surface they should not be used. (2) When handling the mounted boards, be careful that the mounted components do not come in contact with or bump against other boards or components. 						
8. Storage conditions							
Precautions	<p>◆Storage</p> <ol style="list-style-type: none"> 1. To maintain the solderability of terminal electrodes and to keep the packaging material in good condition, care must be taken to control temperature and humidity in the storage area. Humidity should especially be kept as low as possible. <ul style="list-style-type: none"> •Recommended conditions <table border="0" style="margin-left: 20px;"> <tr> <td>Ambient temperature: Below 30°C</td> <td>Humidity: Below 70% RH</td> </tr> </table> The ambient temperature must be kept below 40°C. Even under ideal storage conditions, solderability of inductor is deteriorated as time passes, so inductors should be used within 6 months from the time of delivery. •Inductor should be kept where no chlorine or sulfur exists in the air. 	Ambient temperature: Below 30°C	Humidity: Below 70% RH				
Ambient temperature: Below 30°C	Humidity: Below 70% RH						
Technical considerations	<p>◆Storage</p> <ol style="list-style-type: none"> 1. If the parts are stocked in a high temperature and humidity environment, problems such as reduced solderability caused by oxidation of terminal electrodes and deterioration of taping/packaging materials may take place. For this reason, components should be used within 6 months from the time of delivery. If exceeding the above period, please check solderability before using the inductors. 						

▶ This catalog contains the typical specification only due to the limitation of space. When you consider the purchase of our products, please check our specification. For details of each product (characteristics graph, reliability information, precautions for use, and so on), see our Web site (<http://www.ty-top.com/>).

X-ON Electronics

Largest Supplier of Electrical and Electronic Components

Click to view similar products for [Fixed Inductors](#) category:

Click to view products by [Taiyo Yuden](#) manufacturer:

Other Similar products are found below :

[MLZ1608M6R8WTD25](#) [MLZ1608N6R8LT000](#) [MLZ1608N3R3LTD25](#) [MLZ1608N3R3LT000](#) [MLZ1608N150LT000](#)
[MLZ1608M150WTD25](#) [MLZ1608M3R3WTD25](#) [MLZ1608M3R3WT000](#) [MLZ1608M150WT000](#) [MLZ1608A1R5WT000](#)
[MLZ1608N1R5LT000](#) [B82432C1333K000](#) [PCMB053T-1R0MS](#) [PCMB053T-1R5MS](#) [PCMB104T-1R5MS](#) [CR32NP-100KC](#) [CR32NP-151KC](#) [CR32NP-180KC](#) [CR32NP-181KC](#) [CR32NP-1R5MC](#) [CR32NP-390KC](#) [CR32NP-3R9MC](#) [CR32NP-680KC](#) [CR32NP-820KC](#)
[CR32NP-8R2MC](#) [CR43NP-390KC](#) [CR43NP-560KC](#) [CR43NP-680KC](#) [CR54NP-181KC](#) [CR54NP-470LC](#) [CR54NP-820KC](#) [CR54NP-8R5MC](#)
[MGDQ4-00004-P](#) [MGDU1-00016-P](#) [MHL1ECTTP18NJ](#) [MHL1JCTTD12NJ](#) [PE-51506NL](#) [PE-53601NL](#) [PE-53630NL](#) [PE-53824SNLT](#) [PE-62892NL](#) [PE-92100NL](#) [PG0434.801NLT](#) [PG0936.113NLT](#) [PM06-2N7](#) [PM06-39NJ](#) [HC2LP-R47-R](#) [HC2-R47-R](#) [HC3-2R2-R](#) [HC8-1R2-R](#)