

PRODUCT SPECIFICATIONS

AXS Strike Master

Dimensions: 19.00, 86.50, 93.00, 118.50, 63.50, 74.00, 99.50, 30.00, 13.35 Overall, 11.1, 10.50, 8, 2.5

Labels: Twin diode (2 colour) LED indicator, Four tamper-resistant stainless steel security screws

Wiring Diagram Labels: Door Sensor, Remote/Exit Switch, Door Strike, Door/call Bell, Alarm Bell/Klaxon, Power Supply (+V 0V)

- Return - Zero volts
- Supply - Range 11 to 28 volts dc or 9 to 20 volts ac
- Door 1 Release Relay - Relay output (normally open)
- Common - Relay common
- Door 1 Release Relay - Relay output (normally closed)
- Alarm/Door 2 Release Relay - Fully floating (w/its free contact)
- Alarm/Door 2 Release Relay - Fully floating (w/its free contact)
- Door/Call Bell - Open collector gate
- Door Sensor - Used to monitor door 1 condition (open/closed)
- Remote Switch - To open door 1 from within secure area

All dimensions in mm

AXS Code Master

Dimensions: 19.00, 86.50, 93.00, 118.50, 63.50, 74.00, 99.50, 30.00, 13.35 Overall, 11.1, 10.50, 8, 2.5

Labels: Twin diode (2 colour) LED indicator, Four tamper-resistant stainless steel security screws

Connection Diagram: System, 5. Indicator input (LED), 4. Weigand data 1, 3. Weigand data 0, 2. Supply - Range 5V to 12V DC, 1. Return - Zero volts

Connect to access control / security system (refer to manufacturer's instructions for connection details).

All dimensions in mm

PRODUCT FEATURES

ANTI VANDAL KEYPAD

VANDAL RESISTANT KEYPAD

GENERAL SERVICE KEYPAD

All **STORM AXS Keypads** incorporate the proven **STORM** switching technology ensuring rapid, reliable and responsive data entry. Specified to survive in different service environments, ranging from exposed, unsupervised public environments to general service / indoor installations. Keypads in the **STORM AXS** range are dimensionally and electrically interchangeable. This allows users, entering codes at all outdoor or indoor access points, to establish and maintain familiarity with the keypad features.

Whilst every effort is made to ensure details are correct at time of print, specifications are subject to change without notice.

	DE1KT1	DEPLXT2	DE2KT1
Strike Master	DE1KT1	DEPLXT2	DE2KT1
Code Master	WE1KT1	WEPLXT2	WE2KT1
Key Life (cycles)	> 4 Million	> 4 Million	> 4 Million
Service Temp (Dry)	-20°C to +70°C	-20°C to +70°C	-20°C to +70°C
Keypad Material	Chromed Zinc	Super Impact Polymer	Super Impact Polymer
Keypad Colour	Silver	Black	Mid Grey
Keypad Material	Chromed Zinc	Chromed Zinc	Super Impact Polymer
Keypad Colour	Silver	Silver	Light Grey
Keypad Legends	Engraved	Engraved	Laser Marked
Legend Colour	Black	Black	Dark Grey
Contact Materials	Carbon / Gold	Carbon / Gold	Carbon / Gold
Weather Sealed	IP65	IP65	IP65
Resistance to Static Discharge	> 12.5 KV	> 12.5 KV	> 12.5 KV



AXS-LIT-01 1SS.3

STORM, AXS, STRIKE MASTER & CODE MASTER ARE TRADEMARKS OF KEYMAT TECHNOLOGY LTD.

www.keymat.com



FM 39602



450-B Industrial Drive, Fort Collins, CO 80524
Tel: 970-221-2201 Fax: 970-484-4078

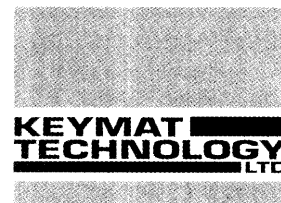

14 Bentinck Court Bentinck Road
West Drayton UB7 7RQ England
Telephone: +44/(0)1895 431421
Telefax: +44/(0)1895 431132

STORM AXS-COM Intercom for Access Control.

STORM AXS-COM is a two-way voice communication system. From the comfort and safety of your favourite chair you can talk with caller's at your door. This allows you to check their identity and reason for calling before you open the door. By pressing a lock-release button, located in your personal handset, the door can be unlocked for a few seconds, allowing one person to enter. The door automatically re-locks on closing.

The AXS-COM is a "stand-alone" system; alternatively it can be used in conjunction with **STORM AXS Access Control Keypads**.

AXS-COM is available in two versions. One providing communication between the caller and a single internal location, the other providing communication between the caller and up to four internal locations (e.g. individual residences). Each AXS-COM comes complete with one handset, incorporating a remote lock-release button. Additional handsets are available from your chosen AXS-COM supplier.

The AXS-COM is a versatile device for use with suitable d.c. or a.c. powered systems. It is compatible with most electrically operated releases and locks.

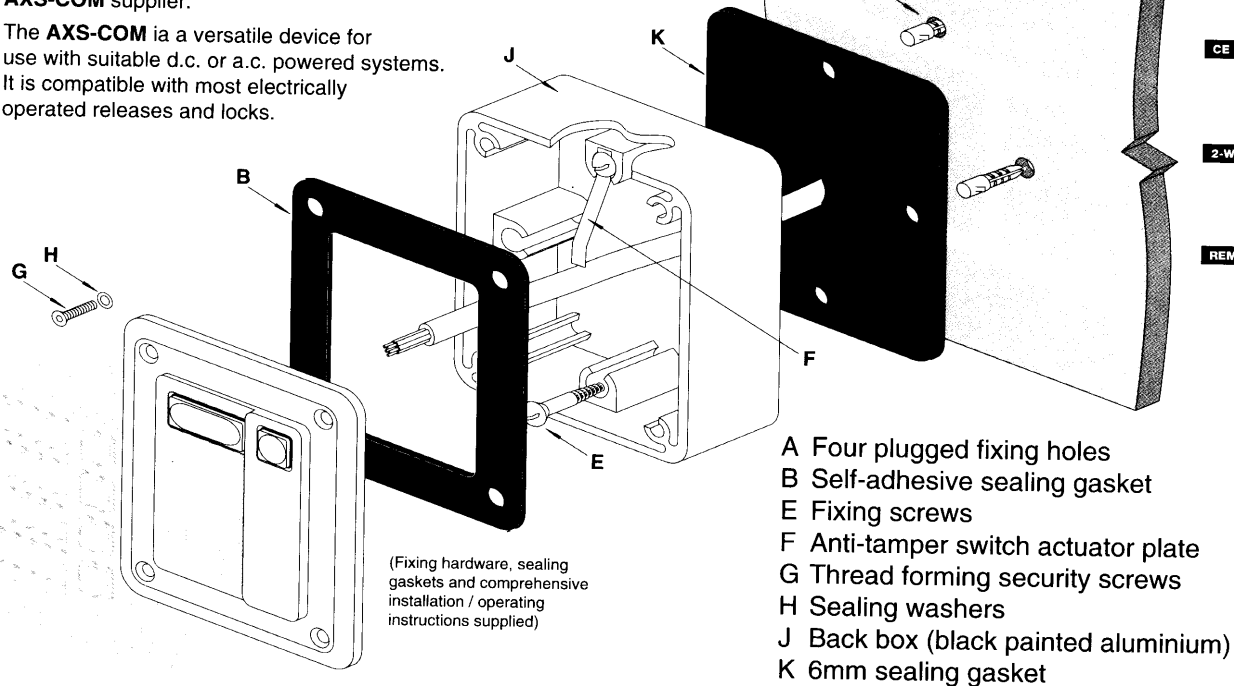

- A Four plugged fixing holes
- B Self-adhesive sealing gasket
- E Fixing screws
- F Anti-tamper switch actuator plate
- G Thread forming security screws
- H Sealing washers
- J Back box (black painted aluminium)
- K 6mm sealing gasket

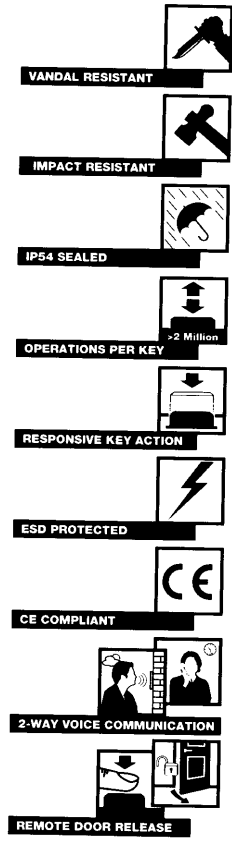

PRODUCT FEATURES

- Tough, weather-resistant and vandal-resistant construction
- d.c. System gives clear, two-way voice communication
- Anti-tamper alarm output for improved security
- 1 and 4 doorbell / call button(s)
- Quick and easy installation
- 1-4 station communication
- Can be used to control a wide range of a.c. or d.c. electric door releases and locks
- Power supply 11-28V d.c., 9-20V a.c.
- Station identity inserts provided (blank)
- Wall or flush panel mountable

PART DESCRIPTION	PART NUMBER
AXS-COM (1 Station)	IC0102
AXS-COM (4 Station)	IC0402
ACCESSORIES (AVAILABLE SEPARATELY)	
Additional Handset	HS0002
Privacy Shroud	1KFS02
Electric Releases	DEST02
Power Supply	DEPS02



storm[®] Privacy Shroud

Front mounted Privacy Shroud for use with STORM K Range and AXS Keypads. The Privacy Shroud provides added security for financial transactions, access control or other applications where the PIN or Entry Code should be protected against observation or surveillance. The Privacy Shroud locates onto the four keypad fixing positions making installation quick and easy. The STORM Privacy Shroud is intended for use with STORM AXS keypads for access control and STORM K Range 12-key keypads. (To achieve higher level PIN Code security when using STORM AXS StrikeMaster keypads, the 'hidden entry code' feature can also be utilised.).

NEW

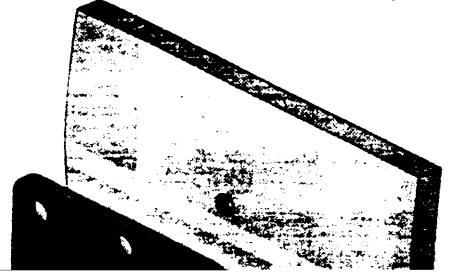

With rising
crime rates and
an increasing

It is essential to provide for more law enforcement

A CHOICE OF ELECTRONIC INTERFACES

AXS Strike Master

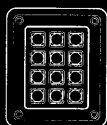

Secure, self-contained keypad and controller for electrically operated locks and strikes.

Authorised personnel can use their PIN code to open either one or two normally locked doors. Up to 50 different 4, 5 or 6 digit codes can be individually programmed. Each code can be set to trigger an electric lock or strike for a pre-set time (allowing just one person to access), or to 'latch' the door in an unlocked condition (requiring the code to be re-entered to 'unlatch' or re-lock the door). If the Strike Master keypad is used to control a single door, the 'forced door alarm', 'anti-tamper alarm' and 'duress alarm' features can be enabled.

- Up to 50 user programmable PIN codes
- 4, 5 or 6 digit PIN codes
- Indexing permits the secure allocation and re-allocation of PIN codes
- One or two door control
- Anti-tamper alarm
- PIN code entered under duress alarm
- Forced door alarm
- Timed release or latched door option for each PIN code
- Fail (open) Fail (closed) option
- Timed lock out for repeated invalid code input
- Remote exit switch facility
- Hidden PIN code feature
- All weather resistant
- LED and audible tone status indication
- Requires 11 to 28V DC or 9 to 20V AC supply
- Quick and easy to install
- Three protection levels:
 - i) Anti-vandal keypad for exposed, unsupervised hostile, public locations
 - ii) Vandal resistant keypad for unsupervised, public, outdoor locations
 - iii) Robust keypad for outdoor/indoor location

AXS -COM

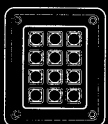

A Secure, self contained, two way voice communication system in 1 and 4 doorbell/callbutton versions

AXS Code Master

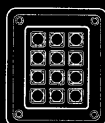

Converts codes entered via the keypad into industry standard (Weigand) data. Suitable for use as a replacement for (or in conjunction with) most standard card readers.

Intended for use with integrated access control / security systems, the keypad's electronic interface is user programmable for 26 or 32 bit (Weigand) data output.

- Selectable 'keypress' audible tone
- Selectable 'code accepted' audible tone
- All weather resistant
- LED status indication
- Requires 5V to 12V DC supply
- Quick and easy to install
- Three protection levels:
 - i) Anti-vandal keypad for exposed, unsupervised hostile, public locations
 - ii) Vandal resistant keypad for unsupervised, public, outdoor locations
 - iii) Robust keypad for outdoor/indoor location

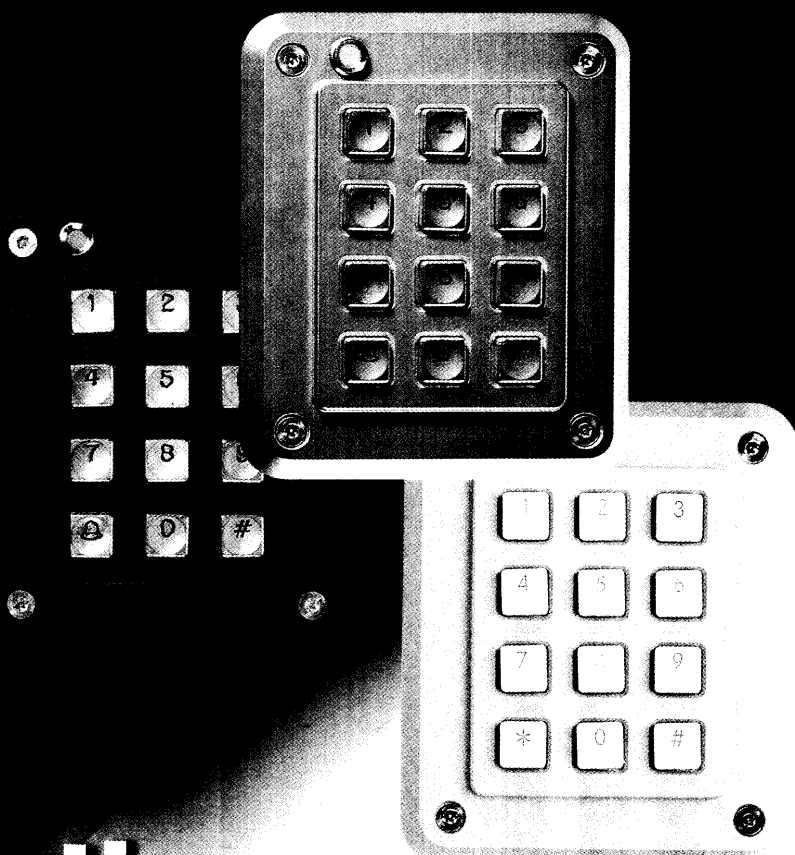

The Secure Alternative

X-ON Electronics

Largest Supplier of Electrical and Electronic Components

Click to view similar products for [storm interface manufacturer](#):

Other Similar products are found below :

[1605-330013](#) [FT1K0503](#) [3K042103](#) [3KLW041103](#) [7207-0410203](#) [7207-121W203](#) [GS000201](#) [3KLW120101](#) [2210-452223](#) [EZB6-430003](#)
[PLX041203](#) [DEEX0103](#) [DEGL12003](#) [1K042103](#) [2K120103](#) [4500-003](#) [DE1KT103](#) [DE2KT103](#) [WE2KT103](#) [8616-310023](#) [7203-12T0203](#)
[1200-MK0003](#) [DEL6003](#) [PLX120203](#) [2K12T103](#) [5100-1003](#) [5103-1003](#) [8616-210023](#) [RC120201](#) [DR2KW203](#) [EZB2-505H03](#) [EZB6-](#)
[530023](#) [EZB2-405003](#) [6000-210023](#) [FT1K0803](#) [FT4K0903](#) [2K160103](#) [EZ08-23001](#) [FT4K1003](#) [2200-003003](#) [3K160103](#) [5100-0003](#) [5100-](#)
[FK03](#) [5103-0103](#) [DXPS1W303](#) [7202-16T0203](#) [8600-MK0003](#) [WE1KT103](#) [DEL12003](#) [EZB6-630023](#)