

APPLICATION TOOLING

Crimping tools and machines

The arrow mark indicates the press that is applicable to the applicator.

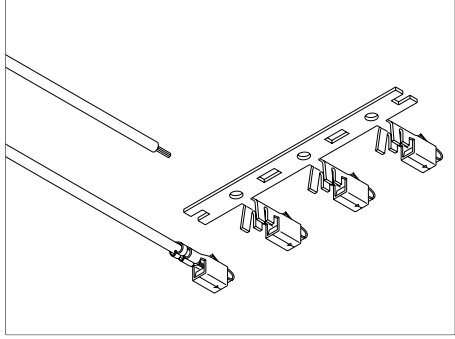

MKS-SC
Strip-crimp applicator
for side feeding terminals

MK-L
Crimping applicator
for end-feeding terminals











MKS-L
Crimping applicator
for side-feeding terminals

MKF-L
Crimping applicator
for end-feeding flag terminals

MKS-LS
Compact crimping applicator
for side-feeding terminals

AP-K2N
Semi-automatic crimping machines (presses)
contact a wire to a chain terminal each time a
footswitch is pressed.

- Dimensions: (WxLxH)280x480x505mm
- Weight: Approx. 90kg(198lb)
- Power source: 100V AC, Single-phase 50/60Hz
- Pressure output: 14.7kN(1,500kgf(3307lb))
- Dies: Applicator replacement

Extraction and Insertion tools	Hand tools	Hand tools						For chain terminals																				
Insertion tool	Extraction tool	for loose piece terminals	for loose piece terminals	for loose piece terminals	for loose piece terminals	for loose piece terminals	for loose piece terminals	for chain terminals																				
 <p>Insertion tool allows contacts be inserted in the housing. This tool greatly increases efficiency especially when thin wires are used.</p>	 <p>Extraction tool is used to extract contacts improperly inserted in the housing.</p>	<p>Hand tools</p> <p>JUK's Hand Tools</p> <p>WC & JUC series</p> <p>Terminal in loose form</p> <p>model No.</p>	<p>Hand tools</p> <p>JUK's Hand Tools</p> <p>WC & JUC series</p> <p>Terminal in loose form</p> <p>model No.</p>	<p>Hand tools</p> <p>YRK-EX series</p> <p>Dimensions: (WxLxH) 75x31x25mm</p> 	<p>Hand tools</p> <p>YRK series</p> <p>Dimensions: (WxLxH) 75x31x25mm</p> 	<p>Hand tools</p> <p>YRF series</p> <p>Dimensions: (WxL) 70x295mm</p> 	<p>Hand tools</p> <p>YRM series</p> <p>Dimensions: (WxL) 59x224mm</p> 	<p>Hand tools</p> <p>YRS series</p> <p>Dimensions: (WxL) 59x224mm</p> 	<p>JK-SP/SS2***</p> <p>YRS-370</p> <p>YC-440</p>	<p>DEJ-0.3</p> <p>J-BP/BS1***</p> <p>KEU-0.7 for plug, KEU-0.4 for socket</p>	<p>JUCS-FO</p> <p>JUCS-FO</p> <p>MEJ-06</p> <p>MEJ-06</p>	<p>YRK-232</p> <p>YRM-233</p> <p>YRM-230</p>	<p>YRS-331</p> <p>YRS-331</p> <p>YRS-331</p>	<p>YRS-331</p> <p>YRS-331</p> <p>YRS-331</p>	<p>YRS-331</p> <p>YRS-331</p> <p>YRS-331</p>	<p>YRS-331</p> <p>YRS-331</p> <p>YRS-331</p>	<p>YRS-331</p> <p>YRS-331</p> <p>YRS-331</p>	<p>Hand tools</p> <p>YRS series</p> <p>Dimensions: (WxL) 59x224mm</p> 	<p>J-SP/SS1***</p> <p>YRS-440</p> <p>YC-440</p>	<p>DEJ-0.3</p> <p>J-BP/BS1***</p> <p>KEU-0.7 for plug, KEU-0.4 for socket</p>	<p>JUCS-FO</p> <p>JUCS-FO</p> <p>MEJ-06</p> <p>MEJ-06</p>	<p>YRK-232</p> <p>YRM-233</p> <p>YRM-230</p>	<p>YRS-331</p> <p>YRS-331</p> <p>YRS-331</p>	<p>YRS-331</p> <p>YRS-331</p> <p>YRS-331</p>	<p>YRS-331</p> <p>YRS-331</p> <p>YRS-331</p>	<p>YRS-331</p> <p>YRS-331</p> <p>YRS-331</p>	<p>YRS-331</p> <p>YRS-331</p> <p>YRS-331</p>	<p>Hand tools</p> <p>YRS series</p> <p>Dimensions: (WxL) 59x224mm</p> 
									<p>J-SP/SS2***</p> <p>YRS-330</p> <p>YC-440</p>	<p>DEJ-0.3</p> <p>J-BP/BS1***</p> <p>KEU-0.7 for plug, KEU-0.4 for socket</p>	<p>JUCS-FO</p> <p>JUCS-FO</p> <p>MEJ-06</p> <p>MEJ-06</p>	<p>YRK-232</p> <p>YRM-233</p> <p>YRM-230</p>	<p>YRS-331</p> <p>YRS-331</p> <p>YRS-331</p>	<p>YRS-331</p> <p>YRS-331</p> <p>YRS-331</p>	<p>YRS-331</p> <p>YRS-331</p> <p>YRS-331</p>	<p>YRS-331</p> <p>YRS-331</p> <p>YRS-331</p>	<p>YRS-331</p> <p>YRS-331</p> <p>YRS-331</p>	<p>Hand tools</p> <p>YRS series</p> <p>Dimensions: (WxL) 59x224mm</p> 										

Terminals and parts model number in alphabetical order

Note: (1) These tools are for prototype tooling or repair.
(2) YRS tool has two crimping sections (A and B). YRS tool has also two crimping sections by inserting upper dies.
(3) YRS tool has two crimping sections (A and B). YRS tool has also two crimping sections by inserting upper dies.
(4) YRS tool has two crimping sections (A and B). YRS tool has also two crimping sections by inserting upper dies.

It is the manual tool that is convenient to terminate very small quantity of contacts for prototype or maintenance.
YRK and YRK-EX can be used for mass-production.
Before use, check for proper crimping (such as tensile strength, terminal/contact deformation).
These tools are not applicable to 2-wire crimping.
Applicable wires described in this catalog may not be crimped properly.
Be sure to check applicable wires before use. Since the dies are kned, the crimping height cannot be adjusted. Therefore, some of the

YRS series
YRS-492
SCZH-002T-P0.5
SCSN-41T-P2.3
SCS-41T-2.3
SCN-001T-P1.0
SCN-001T-1.0K
SBN-001T-1.0
SBHT-002T-P0.5
SBHSM-002T-P0.5
SBHS-002T-P0.5A
SBHS-002T-P0.5A
SBHM-001T-P0.5
SBHL-002T-P0.5
SBH-001T-P0.5
SAN-002T-0.8K
SAN-002T-0.8A
SACH-002GU-P0.3
SAB-51(T)-**
SAA-51(T)-**
SAA-50(T)-**
SAA-21(T)-**
RPI-SP/SS2331
RF-SC22**
RA-SC1290
MD-SP22**
MD-SP12**
LFO-2.5-250N
LFO-1.0-250N
J-SP/SS2***
J-SP/SS1***

Note: Contact JST for wire range.

Note: Contact JST for wire range.

Terminals and parts model		Hand tools							for chain terminals		Hand tools							for loose piece terminals		
number in alphabetical order		JVC series			YRF series			YRK · YRK-EX series				WC & JVC series JUK's Hand Tools			Terminal in loose form model No.		Extraction tool		Insertion tool	
SDF-01T-1.0A	YC-045	YC-045													LDF-01T-1.0A					
SDF-01T-1.3AS	YC-045	YC-045													LDF-01T-1.3AS					
SDN-21T-P1.5	YC-600R	YC-600R													BDN-21T-P1.5					
SDY-01T-P1.6ASV	YC-525R	YC-525R													BDY-01T-P1.6ASV					
SEH-001T-P0.6	YRS-260	YRS-260													BEH-001T-P0.6					
SEH-003T-P0.6L																				
SEH-002T-P0.6L																				
SF1F-002(·)-P0.6																				
SF1F-21(·)-P0.6																				
SF1M-21(·)-M0.6A																				
SF1M-002(·)-M0.6A																				
SF1F-002(·)-P2.0																				
SF3F-01(·)-P2.0																				
SF3F-01(·)-P2.0																				
SF3M-01(·)-M2.0N																				
SF3F-41(·)-P2.0																				
SF3M-41(·)-M2.0N																				
SF3F-71(·)-P2.0																				
SF3M-71(·)-M2.0N																				
SF0-41(·)-187N(8)	YC-271	YC-271																		
SF0-61(·)-250A	YC-270	YC-270																		
SFPS-61T-250	YC-272	YC-272																		
SFT-61T-250N	YC-510	YC-510																		
SGF-41(·)-4	YC-055	YC-055																		
SGF-51(·)-5	YC-065	YC-065																		
SGM-51T-5	YC-056	YC-056																		
SHCM-A03T-P025	YRS-960	YRS-960																		
SHF-001T-0.8BS	YRS-122	YRS-122																		
SHF-002T-0.8BS	YRS-300	YRS-300																		
SHIF-01T-P0.5	YC-986R	YC-986R																		
SHIF-21T-P0.5	YC-995R	YC-995R																		
SHM-01T-P0.5	YC-986R	YC-986R																		
SHM-21T-P0.5	YC-995R	YC-995R																		
SHR-001T-P0.6	YC-580R	YC-580R																		
SIM-01(·)-110A	YC-054	YC-054																		
SIM-1.0-250D/N																				
SIM-2.5-250D/N																				
SIM-41(·)-110B	YC-067	YC-067																		
SIM-51(·)-250N	YC-321	YC-321																		
SIN-001T-1.2	YRS-034	YRS-034																		
SIN-002T-1.0S																				
SIN-01T-1.2	YC-340R	YC-340R																		
SIN-01T-1.8	YC-022	YC-022																		
SIN-01T-1.8N	YC-022	YC-022																		
SIN-21T-1.8	YC-350	YC-350																		
SIN-21T-1.8S	YC-570	YC-570																		
SIN-21T-1.8N	YC-571	YC-571																		
SIN-61T-2.6S	YC-560	YC-560																		
SIN-81T-3.6S	YC-940	YC-940																		

Note: Contact JST for wire range.

Terminals and parts model number in alphabetical order	for chain terminals			Hand tools					
	YRS series	YC series	YRM series	YRF series	YRK · YRK-EX series	WC & JUC series JUK's Hand Tools	Terminal in loose form model No.	Extraction tool	Insertion tool
S12F-002GF-P1.0	YRS-8851	-	-	-	YRK-8851	-	-	EJ-JFA2N	-
S12M-002GF-M1.0N	YRS-8851	-	-	-	YRK-8851	-	-	EJ-JFA2N	-
S12F-01GF-P1.0	YRS-8861	-	-	-	YRK-8861	-	-	EJ-JFA2N	-
S12M-01GF-M1.0N	YRS-8861	-	-	-	YRK-8861	-	-	EJ-JFA2N	-
S12F-21GF-P1.0	-	-	-	-	YRF-1120	-	L2F-21GF-P1.0	EJ-JFA2N	-
S12M-21GF-M1.0N	-	-	-	-	YRF-1120	-	L2M-21GF-M1.0N	EJ-JFA2N	-
S14F-71GF-M3.0	-	-	-	-	YRF-1130	-	B14F-71GF-M3.0	EJ-JFAJ4	-
S14F-81GF-M3.0	-	-	-	-	YRF-1370	-	B14F-81GF-M3.0	EJ-JFAJ4	-
S15F-71GF-M6.5	-	-	-	-	YRF-888	-	L15F-71GF-M6.5	EJ-JFAJ5	-
S15M-71GF-M6.5	-	-	-	-	YRF-888	-	L15M-71GF-M6.5	EJ-JFAJ5	-
S15F-81GF-M6.5	-	-	-	-	YRF-889	-	L15F-81GF-M6.5	EJ-JFAJ5	-
S15M-81GF-M6.5	-	-	-	-	YRF-889	-	L15M-81GF-M6.5	EJ-JFAJ5	-
S15F-91GF-M6.5	-	-	-	-	-	-	L15F-91GF-M6.5	EJ-JFAJ5	-
S15M-91GF-M6.5	-	-	-	-	-	-	L15M-91GF-M6.5	EJ-JFAJ5	-
S1N-001PT-0.9	YRS-1181	-	-	-	-	-	-	-	-
S1N-002PT-0.9	YRS-036	-	-	-	-	-	-	-	-
SLC-21T-2.0	-	YC-310	-	-	-	WC-310	L1C-21T-2.0	EJ-LC	-
SLC-22T-2.0	-	-	-	-	-	-	-	EJ-LC	-
SLC-001T-P2.0	-	-	-	-	-	-	-	EJ-LCL	-
SLC-02T-P2.0	-	-	-	-	-	-	-	EJ-LCL	-
SLFM-01T-P1.3E	YC-202	YRM-201	-	-	WC-202	LLFM-01T-P1.3E	LEJ-13	-	-
SLFM-41T-P1.3E	YC-203	-	-	-	WC-203	LLFM-41T-P1.3E	LEJ-13	-	LIT-2013
SMF-01T-1.0	YC-081	-	-	-	-	LMF-01T-1.0	-	-	-
SMF-01T-1.3	YC-082	-	-	-	-	LMF-01T-1.3	-	-	-
SMM-003T-P0.5	YRS-800	-	-	-	WC-800	-	-	-	-
SMR-001T-0.6	YC-580R	-	-	-	-	BMR-001T-0.6	-	-	-
SOM-21(T)-187	YC-680	-	-	-	-	LOM-21(T)-187	-	-	-
SOM-51(T)-250	YC-066	-	-	-	WC-066	LOM-51(T)-250	-	-	-
SOTZP-002GD-P0.18	-	-	-	-	-	-	-	EJ-OTZS	-
SPA-001T-P0.5	YC-610R	YC-610R	YC-610R	-	-	BPA-001T-P0.5	-	EJ-PH	-
SPAL-001T-P0.5	-	YC-611R	-	-	-	BPAL-001T-P0.5	-	EJ-PAL	-
SPAL-002T-P0.5	YRS-1340	-	-	-	-	-	-	EJ-PAL	-
SPB-1.0-250N-S	-	-	-	-	-	JUCS-PB	-	-	-
SPB-2.5-250N-S	-	-	-	-	-	JUCS-PB	-	-	-
SPF-01T-2.5C	-	YC-043R	-	-	-	LPF-01T-2.5C	-	-	-
SPH-001T-P0.5L	YRS-245	-	-	-	-	-	-	EJ-PH	-
SPH-002T-P0.5L	YRS-241	-	-	-	-	-	-	EJ-PH	-
SPH-002T-P0.5S	YRS-240	YRM-240	-	-	WC-240	BPH-002T-P0.5S	-	EJ-PH	-
SPH-004T-P0.5S	YRS-243	-	-	-	-	-	-	EJ-PH	-
SPHD-001T-P0.5	-	YC-610R	-	-	WC-610	BPHD-001T-P0.5	-	EJ-PHD-RB	-
SPHD-002T-P0.5	YRS-620	-	YRM-620	-	WC-620	BPHD-002T-P0.5	-	EJ-PHD-RB	-
SPPL-002T-P0.5	YRS-1410	-	-	-	-	-	-	-	-
SPND-001T-C0.5	YRS-1091	-	-	-	-	-	-	EJ-PND	-
SPND-002T-C0.5	YRS-1090	-	-	-	-	-	-	EJ-PND	-

Terminals and parts model number in alphabetical order	for chain terminals		Hand tools						Insertion tool	
	YRS series	YC series	YRM series	YRF series	YRK · YRK-EX series	JUC's Hand Tools	WC & JUC series	JUK's Hand Tools		Terminal in loose form model No.
SPS-01T-110	-	YC-740	-	-	-	WC-740	-	LPs-01T-110	-	-
SPS-01T-187(-8)	-	YC-731	-	-	-	WC-730	-	LPs-01T-187(-8)	EJ-PS187	-
SPS-21T-250	-	YC-760	-	-	-	WC-780	-	LPs-21T-250(-5)	EJ-PS250	-
SPS-21T-250S	-	YC-780	-	-	-	WC-780	-	LPs-21T-250S	EJ-PS250	-
SPS-41T-110	-	YC-751	-	-	-	WC-750	-	LPs-41T-110	-	-
SPS-51T-205	-	YC-771	-	-	-	-	-	LPs-51T-205	-	-
SPS-61T-250	-	YC-720	-	-	-	WC-720	-	LPs-61T-250	EJ-PS250	-
SPS-61T-250S	-	YC-721	-	-	-	-	-	LPs-61T-250S	EJ-PS250	-
SPS-91T-250	-	-	-	-	-	-	-	BPs-91T-250	EJ-PS250	-
SPUD-001T-P0.5	-	YRS-1320	-	-	-	-	-	-	EJ-PUD	-
SPUD-002T-P0.5	-	-	-	-	-	-	-	-	EJ-PUD	-
SPXA-001T-P0.6	-	-	-	-	-	-	-	-	EJ-PXA	-
SRA-20(T)-*	-	YC-181	-	-	-	-	-	LRA-20(T)-*	-	-
SRA-21(T)-*	-	YC-141	-	-	-	-	-	LRA-21(T)-*	-	-
SRA-50(T)-*	-	YC-182	-	-	-	-	-	LRA-50(T)-*	-	-
SRA-51(T)-*	-	YC-142	-	-	-	-	-	LRA-51(T)-*	-	-
SRB-1.0(-)	-	-	-	-	-	-	-	-	-	-
SRB-2.5(-)	-	-	-	-	-	-	-	-	-	-
SRB-51(T)-*	-	YC-142	-	-	-	-	-	LRB-51(T)-*	-	-
SRC-01(T)-*	-	YC-033	-	-	-	-	-	LRC-01(T)-*	-	-
SRC-50(T)-*	-	YC-183	-	-	-	-	-	LRC-50(T)-*	-	-
SRC-51(T)-*	-	YC-142	-	-	-	-	-	LRC-51(T)-*	-	-
SRT-1.0(-)	-	-	-	-	-	-	-	-	-	-
SRT-2.5(-)	-	-	-	-	-	-	-	-	-	-
SRT-51T-*	-	YC-143R	-	-	-	-	-	LRT-51T-*	-	-
SRWF-01GG-M0.6	-	-	-	-	-	-	-	-	EJ-RPZ	-
SRWF-01GG-S0.6	-	-	-	-	-	-	-	-	EJ-RPZ	-
SRWF-21GG-M0.6	-	-	-	-	-	-	-	-	EJ-RPZ	-
SRWF-21GG-S0.6	-	-	-	-	-	-	-	-	EJ-RPZ	-
SRWF-61GG-M0.6	-	YC-840R	-	-	-	-	-	-	EJ-RPZ	-
SRWF-61GG-S0.6	-	YC-840R	-	-	-	-	-	-	EJ-RPZ	-
SRFH-001T-P0.5	-	-	-	-	-	-	-	-	EJ-SFH	-
SRFH-002T-P0.5	-	-	-	-	-	-	-	-	EJ-SFH	-
SSH-003T-P0.2-H	-	YRS-859	-	-	-	-	-	-	-	-
SSH-003GA-P0.2	-	YRS-859	-	-	-	-	-	-	-	-
SSH-002T-P0.2	-	YRS-1140	-	-	-	-	-	-	-	-
SSH-003T-P0.2	-	YRS-859	-	-	-	-	-	-	-	-
SSH-003GA-P0.2	-	YRS-859	-	-	-	-	-	-	-	-
SSHL-003T-P0.2	-	-	-	-	-	-	-	-	-	-
SSHL-003GA-P0.2	-	-	-	-	-	-	-	-	-	-
SSFM-01T-P1.4	-	YC-500	-	-	-	-	-	BSF/M-01T-P1.4	SLJ-1.4	ITBL-08V
SSFM-21T-P1.4	-	YC-550	-	-	-	WC-550	-	BSF/M-21T-P1.4	SLJ-1.4	-
STI-01(T)-110N	-	-	-	-	-	-	-	LTi-01(T)-110N	-	-

Note: Contact JST for wire range.

Note: Contact JST for wire range.

Terminals and parts model		Hand tools				Hand tools				Terminals and parts model	
number in alphabetical order	for chain terminals	YRS series	YC series	YRM series	YRF series	YRK · YRK-EX series	WC & JUC series JUK's Hand Tools	for loose piece terminals		YRS series	YC series
								Terminal in loose form	model No.		
Extraction and Insertion tools		Extraction tool		Insertion tool							
ST1-1.0-250D/N	-	-	-	-	-	-	JUCS-T1	-	-	-	-
ST1-2.5-250D/N	-	-	-	-	-	-	-	-	-	-	-
ST1-41(T)-110N	-	-	YC-063	-	-	-	-	-	-	-	-
ST1-51(T)-250N	-	-	YC-322	-	-	-	-	-	-	-	-
STO-01(T)-110N(-8)	-	-	YC-041	-	-	-	-	-	-	-	-
STO-01(T)-187N(-8)	-	-	YC-042	-	-	-	-	-	-	-	-
STO-0-25-110N	-	-	YC-810	-	-	-	-	-	-	-	-
STO-0.5-110N	-	-	YC-820	-	-	-	-	-	-	-	-
STO-1.0-110N	-	-	-	-	-	-	-	-	-	-	-
STO-1.0-187N	-	-	-	-	-	-	-	-	-	-	-
STO-1.0-250N	-	-	-	-	-	-	-	-	-	-	-
STO-21(T)-205N	-	-	YC-053	-	-	-	-	-	-	-	-
STO-21(T)-250N	-	-	YC-102	-	-	-	-	-	-	-	-
STO-41(T)-110N(-8)	-	-	YC-062	-	-	-	-	-	-	-	-
STO-41(T)-187N(-8)	-	-	YC-051	-	-	-	-	-	-	-	-
STO-41T-187S	-	-	YC-064	-	-	-	-	-	-	-	-
STO-61(T)-250N	-	-	YC-047	-	-	-	-	-	-	-	-
STO-81(T)-250N	-	-	YC-280	-	YRF-280	-	-	-	-	-	YRS-1360
SVA-41T-P1.1	-	-	YC-450	-	-	-	-	-	-	-	-
SVF-01T-1.5N	-	-	YC-044	-	-	-	-	-	-	-	-
SVF-01T-1.5N	-	-	YC-151	-	-	-	-	-	-	-	-
SVF-01T-2.36N	-	-	YC-152	-	-	-	-	-	-	-	-
SVF-42T-P2.0	-	-	YC-582	-	-	-	-	-	-	-	-
SVM-42T-P2.0	-	-	YC-593	-	-	-	-	-	-	-	-
SVM-61T-P2.0	-	-	YC-590	-	YRF-590	-	-	-	-	-	-
SVM-81T-P2.0	-	-	-	-	YRF-591	-	-	-	-	-	-
SVH-21T-P1.1	-	-	YC-160R	YRM-160	-	-	-	-	-	-	-
SVH-41T-P1.1	-	-	YC-164R	YRM-164	-	-	-	-	-	-	-
SVH-41T-P1.1	-	-	YC-930R	-	-	-	-	-	-	-	-
SVH-41T-P1.1	-	-	YC-931R	-	-	-	-	-	-	-	-
SVT-41T-P1.1	-	-	YC-630	-	-	-	-	-	-	-	-
SVU-21T-P0.6	-	-	YC-990R	-	-	-	-	-	-	-	-
SVYF-61T-P0.5A	-	-	-	-	YRF-536	-	-	-	-	-	-
SWPJT-21T-P0.5	-	-	-	-	-	-	-	-	-	-	-
SWPJT-21T-P0.5A	-	-	-	-	-	-	-	-	-	-	-
SWPJR-21T-M0.5	-	-	-	-	-	-	-	-	-	-	-
SWPJR-21T-0.6	-	-	-	-	-	-	-	-	-	-	-
SWPKP-21T-0.6	-	-	-	-	YRF-1051	-	-	-	-	-	-
SWPKR-21T-0.6	-	-	-	-	YRF-1050	-	-	-	-	-	-
SWPR-001T-P025	-	-	-	-	-	-	-	-	-	-	-
SWPT-001T-P025	-	-	-	-	-	-	-	-	-	-	-
SXA-01T-P0.6	-	-	YC-701R	-	-	-	-	-	-	-	-
SXA-001T-P0.6	-	-	YC-692R	-	-	-	-	-	-	-	-
SXA-001T-P0.6L	YRS-691	-	-	-	-	-	-	-	-	-	-
WC-691	-	-	-	-	-	-	-	-	-	-	-
WC-700M	BXA-01T-P0.6	-	-	-	-	-	-	-	-	-	-
WC-JWPF	-	-	-	-	-	-	-	-	-	-	-
WC-JWPF	-	-	-	-	-	-	-	-	-	-	-
WC-JWPF	BWPKR-21T-0.6	-	-	-	-	-	-	-	-	-	-
WC-JWPF	BWPKP-21T-0.6	-	-	-	-	-	-	-	-	-	-
EJ-XMP	-	-	-	-	-	-	-	-	-	-	-
EJ-XMP	-	-	-	-	-	-	-	-	-	-	-
EJ-XMP	EJ-XMP, EJ-XMR	-	-	-	-	-	-	-	-	-	-
EJ-XAG, EJ-XMP	BXA-01T-P0.6	-	-	-	-	-	-	-	-	-	-
EJ-XMP, EJ-XMR	BXA-001T-P0.6	-	-	-	-	-	-	-	-	-	-
IT-XA	-	-	-	-	-	-	-	-	-	-	-

Terminals and parts model number in alphabetical order	for chain terminals			Hand tools				Insertion tool
	YRS series	YC series	YRM series	YRF series	YRK · YRK-EX series	WC & JUC series JUK's Hand Tools	Terminal in loose form model No.	
SXAM-01T-P0.6	YRS-701	YC-701R	-	-	-	WC-700M	BXAM-01T-P0.6	EJ-XAW
SXAM-001T-P0.6	YRS-692R	YC-692R	-	-	-	-	BXAM-001T-P0.6	EJ-XAW
SXF-01T-P0.7	YC-251	YC-251	-	-	-	-	BXF-01T-(P)0.7	LEJ-7
SXF-41T-P0.7	-	YC-252	-	-	-	-	BXF-41T-(P)0.7	LEJ-7
SXH-001T-P0.6N	-	-	-	-	-	-	-	XJ-06
SXH-002T-P0.6	YRS-480	-	-	-	-	-	-	XJ-06
SXM-01T-P0.6	YRS-701	YC-701R	-	-	-	-	BXM-01T-P0.6	EJ-XAG,EJ-XMP
SXM-001T-P0.6	YRS-692R	YC-692R	-	-	-	-	BXM-001T-P0.6	EJ-XMP, EJ-XMR
SXNI-001T-P0.6	YRS-1380	-	-	-	-	-	-	-
SXNI-003T-P0.6	YRS-1390	-	-	-	-	-	-	-
SXF-001T-P0.6	YRS-125	-	-	-	-	-	-	-
SVF/M-01T-P0.5A	YC-520	-	-	-	-	WC-520	BYF/M-01T-P0.5A	YJLJ-0.5
SVF/M-41T-P0.5A	YC-530	-	-	-	-	WC-530	BYF/M-41T-P0.5A	YJLJ-0.5
SVF-61T-P0.5A	-	-	-	YRF-536	-	-	-	-
SVM-001T-P0.6	YRS-121	YC-121R	-	-	-	WC-121	BVM-001T-P0.6	SMJ-06
SVM-01T-P0.7	YC-251	YC-251	-	-	-	-	BVM-01T-(P)0.7	LEJ-7
SVM-41T-P0.7	YC-252	YC-252	-	-	-	-	BVM-41T-(P)0.7	LEJ-7
SZE-002T-P0.3	YRS-1300	-	-	-	-	-	-	-
SZE-003T-P0.3	YRS-1330	-	-	-	-	-	-	-
SZF/M-01T-P0.7	YC-390R	YC-390R	-	-	-	-	BZF/M-01T-(P)0.7	ZLJ-07S
SZF/M-41T-P0.7	-	YC-380R	-	-	-	-	BZF/M-41T-(P)0.7	ZLJ-07S
SZH-002T-P0.5	YRS-491	-	-	-	-	WC-491	-	-
SZH-003T-P0.5	YRS-490	-	-	-	-	WC-490	-	-
SZN-002T-P0.7K	YRS-541	-	-	-	-	-	-	-
SZN-003T-P0.7K	YRS-540	-	-	-	-	-	-	-
SZPD-002T-P0.3	YRS-1460	-	-	-	-	-	-	-

Note: Contact JST for wire range.

YRK series hand crimping tools suitable for mass-production

- Crimping work, such as setting contacts to hand tools etc., is facilitated by using a strip contact to improve the productivity.
- A light operation enables to terminate the contact correctly, by adopting straight-ahead crimping.
- A structure, that the carrier of contact doesn't fly off, has been adopted to this tool.



Dimensions: 75(W)×314(L)×25(D)mm
Weight: Approx. 800g (When assembling dies)

- Hand Crimping Tools**
YRK Standard type
- When exchanging the crimpers, the crimping suitable for the wire specification can be conducted.
 - Anvil is fixed to tool.

Dies replacement type hand crimping tools

YRK-EX

- High reliability of crimping is provided by choosing the crimper and anvil suitable for the wire specification.
- The crimping die can be easily exchanged by only insertion and extraction of pin.
- Common handle and crimping dies can be stored in One case and it is easy to carry.

Patent pending

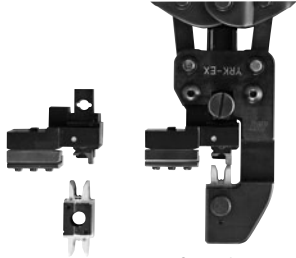

Dimensions: 75(W)×314(L)×25(D)mm
Weight: Approx. 800g (When assembling dies)



Dimensions: 376(W)×295(L)×73(D)mm

Series	Nominal	Contact Model No.		Hand crimp tools	YRK Model No. of crimper	Applicable wire size	
		Tab	Receptacle			Marking	Insulation O.D. (mm)

J1000 Type II	L	SF1F-21(*)-P0.6	SF1M-21(*)-M0.6A	J1LA / B	A #20 1.76	LA	#22 1.58
				J1LB	B #18 2.03	LB	KV0.75 1.90
				J1LC / D	C #22 1.58	LC	#18 2.03
				J1LD	D KV0.75 1.90	LD	#20 1.76
J1000 Type I	S	SJ2F-002GF-P1.0	SJ2M-002GF-M1.0N	J2SA / SB	A #28 1.20	SA	#28 1.20
				J2SB	B #24 1.43	SB	#24 1.43
				J2MA / MB	A #24 1.43	MA	#24 1.43
				J2MB	B #20 1.53 ²	MB	#20 1.53 ²
J2000	M	SJ2F-01GF-P1.0	SJ2M-01GF-M1.0N	J2LA / B	A #22 1.58	LA	#22 1.58
				J2LB	B #20 1.76	LB	#20 1.76
				J2MA / B	A #24 1.43	MA	#24 1.43
				J2MB	B #20 1.53 ²	MB	#20 1.53 ²
J2000	L	SJ2F-21GF-P1.0	SJ2M-21GF-M1.0N	J2LA / B	A #22 1.58	LA	#22 1.58
				J2LB	B #20 1.76	LB	#20 1.76
				J2SA	A #28 1.20	SA	#28 1.20
				J2SB	B #24 1.43	SB	#24 1.43
J3000	S	SF3F-002(*)-P2.0	—	J3SA / B	A #28 1.20	SA	#28 1.20
				J3B	B #24 1.43	SB	#24 1.43
				J3C / D	C #26 1.30	SC	#26 1.30
				J3D	D #24 1.11	SD	#24 1.11
J3000	M	SF3F-01(*)-P2.0	SF3M-01(*)-M2.0N	J3MA / B	A #24 1.43	MA	#24 1.43
				J3B	B #20 1.76	MB	#20 1.76
				J3C / D	C #22 1.58	MC	#22 1.58
				J3D	D #20 2.56	MD	#20 2.56
J3000	M	SF3F-01(*)-P2.0	SF3M-01(*)-M2.0N	J3MA / B	A #24 1.43	MA	#24 1.43
				J3B	B #20 1.76	MB	#20 1.76
				J3C / D	C #22 1.58	MC	#22 1.58
				J3D	D #20 2.56	MD	#20 2.56
J3000	M	SF3F-01(*)-P2.0	SF3M-01(*)-M2.0N	J3MA / B	A #24 1.43	MA	#24 1.43
				J3B	B #20 1.76	MB	#20 1.76
				J3C / D	C #22 1.58	MC	#22 1.58
				J3D	D #20 2.56	MD	#20 2.56
J3000	L	SF3F-41(*)-P2.0	SF3M-41(*)-M2.0N	J3LA / B	A #20 1.76	LA	#20 1.76
				J3B	B #16 2.35	LB	#16 2.35
				J3C / D	C #18 2.03	LC	#18 2.03
				J3D	D #18 2.83	LD	#18 2.83
J3000	L	SF3F-71(*)-P2.0	SF3M-71(*)-M2.0N	J3LA / B	A #16 2.83	LA	#16 2.83
				J3B	B #14 3.30	LB	#14 3.30
				J3C / D	C #18 2.03	LC	#18 2.03
				J3D	D #16 2.83	LD	#16 3.10
J3000	2L	SF3F-71(*)-P2.0	SF3M-71(*)-M2.0N	J32LA / B	A #16 3.10	2LA	#16 3.10
				J32B	B #14 3.30	2LB	#14 3.30

Note: 1. J1000 Finish(*): T.....Tri-plated
 2. J3000 Finish(*): GF.....Gold-plated
 GI.....Nickel-undercoated, 0.79µm selective gold-plated
 T.....Tri-plated
 3. The wear of parts is caused by using hand tool repeatedly.
 Measure the crimping height daily and conduct periodical inspection of the wearing parts, such as ratchet, pin and so on.

Series	Nominal	Contact Model No.		Crimper Model No.	Applicable wire size	
		Tab	Receptacle		Die mark	Insulation O.D. (mm)

X-ON Electronics

Largest Supplier of Electrical and Electronic Components

Click to view similar products for [Crimpers](#) category:

Click to view products by [JST](#) manufacturer:

Other Similar products are found below :

[576771-1](#) [576788-2](#) [010-0041](#) [010-0055](#) [010-0096](#) [604228-1](#) [M225202-37](#) [CT150-2-D02](#) [CT150-4-LY2](#) [CT150-6-RH07](#) [M322](#) [63484-3701](#)
[63800-0140](#) [63800-8355](#) [63811-3275](#) [63811-3376](#) [63811-6375](#) [63811-6475](#) [63811-7875](#) [63811-8175](#) [63811-8875](#) [63819-0475](#) [63819-1875](#)
[63819-2875](#) [63819-4375](#) [63819-4475](#) [63823-3475](#) [63823-5175](#) [63823-6375](#) [63823-8375](#) [63827-5375](#) [64001-0975](#) [64001-2175](#) [64001-4175](#)
[662903-2](#) [690142-4](#) [690602-6](#) [D38999/20WA98JB-LC](#) [7-1633664-2](#) [7-22278-0](#) [7-22280-5](#) [7-240641-3](#) [762637-1](#) [808714-1](#) [8-1633117-3](#)
[853721-6](#) [91362-1](#) [995-0001-187](#) [1-1633932-5](#) [999-50-020083](#)