

FEATURES

Hermetic package offers excellent long-term stability
 0 g offset vs. temperature (all axes): 0.15 mg/°C maximum
 Ultralow noise density (all axes): 20 $\mu\text{g}/\sqrt{\text{Hz}}$ (ADXL354)

Low power, V_{SUPPLY} (LDO enabled)

ADXL354 in measurement mode: 150 μA

ADXL355 in measurement mode: 200 μA

ADXL354/ADXL355 in standby mode: 21 μA

ADXL354 has user adjustable analog output bandwidth

ADXL355 digital output features

Digital serial peripheral interface (SPI)/I²C interfaces

20-bit analog-to-digital converter (ADC)

Data interpolation routine for synchronous sampling

Programmable high- and low-pass digital filters

Electromechanical self test

Integrated temperature sensor

Voltage range options

V_{SUPPLY} with internal regulators: 2.25 V to 3.6 V

$V_{1\text{P8ANA}}$, $V_{1\text{P8DIG}}$ with internal low dropout regulator (LDO)
 bypassed: 1.8 V typical \pm 10%

Operating temperature range: -40°C to $+125^{\circ}\text{C}$

14-terminal, 6 mm \times 6 mm \times 2.1 mm, LCC package,
 0.26 grams

APPLICATIONS

Inertial measurement units (IMUs)/altitude and heading
 reference systems (AHRSs)

Platform stabilization systems

Structural health monitoring

Seismic imaging

Tilt sensing

Robotics

Condition monitoring

GENERAL DESCRIPTION

The analog output ADXL354 and the digital output ADXL355 are low noise density, low 0 g offset drift, low power, 3-axis accelerometers with selectable measurement ranges. The ADXL354B supports the ± 2 g and ± 4 g ranges, the ADXL354C supports the ± 2 g and ± 8 g ranges, and the ADXL355 supports the ± 2.048 g, ± 4.096 g, and ± 8.192 g ranges. The ADXL354/ADXL355 offer industry leading noise, minimal offset drift over temperature, and long term stability enabling precision applications with minimal calibration.

¹ Protected by U.S. Patents 8,472,270; 9,041,462; 8,665,627; 8,917,099; 6,892,576; 9,297,825; and 7,956,621.

Rev. A

[Document Feedback](#)

Information furnished by Analog Devices is believed to be accurate and reliable. However, no responsibility is assumed by Analog Devices for its use, nor for any infringements of patents or other rights of third parties that may result from its use. Specifications subject to change without notice. No license is granted by implication or otherwise under any patent or patent rights of Analog Devices. Trademarks and registered trademarks are the property of their respective owners.

FUNCTIONAL BLOCK DIAGRAMS

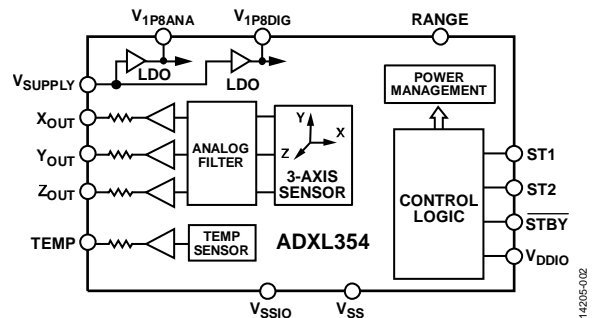

Figure 1. ADXL354 Functional Block Diagram

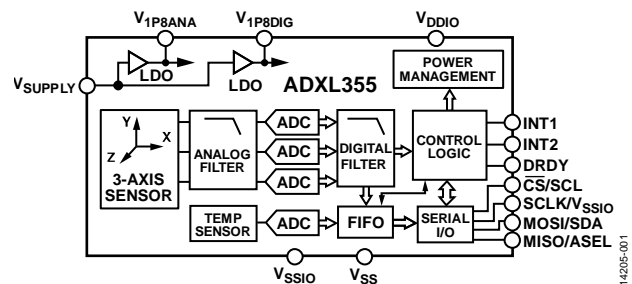

Figure 2. ADXL355 Functional Block Diagram

Highly integrated in a compact form factor, the low power ADXL355 is ideal in an Internet of Things (IoT) sensor node and other wireless product designs.

The ADXL355 multifunction pin names may be referenced by their relevant function only for either the SPI or I²C interfaces.

TABLE OF CONTENTS

Features	1	NVM_BUSY	28
Applications.....	1	External Synchronization and Interpolation	29
Functional Block Diagrams.....	1	ADXL355 Register Map.....	31
General Description	1	Register Definitions.....	32
Revision History	2	Analog Devices ID Register	32
Specifications.....	3	Analog Devices MEMS ID Register.....	32
Analog Output for the ADXL354.....	3	Device ID Register	32
Digital Output for the ADXL355	4	Product Revision ID Register	32
SPI Digital Interface Characteristics for the ADXL355	5	Status Register.....	32
I ² C Digital Interface Characteristics for the ADXL355.....	6	FIFO Entries Register	33
Absolute Maximum Ratings.....	8	Temperature Data Registers.....	33
Thermal Resistance	8	X-Axis Data Registers.....	33
ESD Caution.....	8	Y-Axis Data Registers	34
Pin Configurations and Function Descriptions	9	Z-Axis Data Registers	34
Typical Performance Characteristics	11	FIFO Access Register	35
Root Allan Variance (RAV) ADXL355 Characteristics.....	19	X-Axis Offset Trim Registers.....	35
Theory of Operation	20	Y-Axis Offset Trim Registers	35
Analog Output	20	Z-Axis Offset Trim Registers	36
Digital Output.....	21	Activity Enable Register	36
Axes of Acceleration Sensitivity	21	Activity Threshold Registers.....	36
Power Sequencing	22	Activity Count Register	36
Power Supply Description.....	22	Filter Settings Register	37
Overrange Protection.....	22	FIFO Samples Register	37
Self Test	22	Interrupt Pin (INTx) Function Map Register.....	37
Filter	23	Data Synchronization	38
Serial Communications	25	I ² C Speed, Interrupt Polarity, and Range Register	38
SPI Protocol.....	25	Power Control Register	38
I ² C Protocol.....	26	Self Test Register.....	39
Reading Acceleration or Temperature Data from the Interface	26	Reset Register.....	39
FIFO	27	Recommended Soldering Profile	40
Interrupts.....	28	PCB Footprint Pattern.....	41
DATA_RDY.....	28	Packaging and Ordering Information	42
DRDY Pin.....	28	Outline Dimensions.....	42
FIFO_FULL.....	28	Branding Information.....	42
FIFO_OVR.....	28	Ordering Guide	42
Activity.....	28		

REVISION HISTORY

4/2018—Rev. 0 to Rev.

Added Vibration Parameter, Table 5.....	8
Changes to Overrange Protection Section	22

8/2016—Revision 0: Initial Version

SPECIFICATIONS

ANALOG OUTPUT FOR THE ADXL354

$T_A = 25^\circ\text{C}$, $V_{\text{SUPPLY}} = 3.3\text{ V}$, x-axis acceleration and y-axis acceleration = 0 g, and z-axis acceleration = 1 g, unless otherwise noted.

Table 1.

Parameter	Test Conditions/Comments	Min	Typ	Max	Unit
SENSOR INPUT	Each axis				
Output Full-Scale Range (FSR)	ADXL354B, supports two ranges ADXL354C, supports two ranges		$\pm 2/\pm 4$ $\pm 2/\pm 8$		g
Resonant Frequency ¹			2.4		kHz
Nonlinearity	$\pm 2\text{ g}$		0.1		%
Cross Axis Sensitivity			1		%
SENSITIVITY	Ratiometric to $V_{1\text{PBANA}}$				
Sensitivity at X_{OUT} , Y_{OUT} , Z_{OUT}	$\pm 2\text{ g}$ $\pm 4\text{ g}$ $\pm 8\text{ g}$	368 184 92	400 200 100	432 216 108	mV/g mV/g mV/g
Sensitivity Change due to Temperature	-40°C to $+125^\circ\text{C}$		± 0.01		%/ $^\circ\text{C}$
0 g OFFSET	Each axis, $\pm 2\text{ g}$				
0 g Output for X_{OUT} , Y_{OUT} , Z_{OUT}	Referred to $V_{1\text{PBANA}}/2$	-75	± 25	+75	mg
0 g Offset vs. Temperature (X-Axis, Y-Axis, and Z-Axis) ²	-40°C to $+125^\circ\text{C}$	-0.15	± 0.1	+0.15	mg/ $^\circ\text{C}$
Repeatability ³	X-axis and y-axis Z-axis		± 3.5 ± 9		mg mg
Vibration Rectification Error (VRE) ⁴	$\pm 2\text{ g}$ range, in a 1 g orientation, offset due to 2.5 g rms vibration		<0.4		g
NOISE DENSITY	$\pm 2\text{ g}$				
X-Axis, Y-Axis, and Z-Axis			20		$\mu\text{g}/\sqrt{\text{Hz}}$
Velocity Random Walk	X-axis and y-axis Z-axis		9 13		$\mu\text{m}/\text{sec}/\sqrt{\text{Hr}}$ $\mu\text{m}/\text{sec}/\sqrt{\text{Hr}}$
BANDWIDTH					
Internal Low-Pass Filter Frequency	Fixed frequency, 50% response attenuation		1500		Hz
SELF TEST					
Output Change					
X-Axis			0.3		g
Y-Axis			0.3		g
Z-Axis			1.5		g
POWER SUPPLY					
Voltage Range					
V_{SUPPLY}^5		2.25	2.5	3.6	V
V_{DDIO}		$V_{1\text{PB8DIG}}$	2.5	3.6	V
$V_{1\text{PBANA}}$, $V_{1\text{PB8DIG}}$ with Internal Low Dropout Regulator (LDO) Bypassed	$V_{\text{SUPPLY}} = 0\text{ V}$	1.62	1.8	1.98	V
Current					
Measurement Mode					
V_{SUPPLY} (LDO Enabled)			150		μA
$V_{1\text{PBANA}}$ (LDO Disabled)			138		μA
$V_{1\text{PB8DIG}}$ (LDO Disabled)			12		μA
Standby Mode					
V_{SUPPLY} (LDO Enabled)			21		μA
$V_{1\text{PBANA}}$ (LDO Disabled)			7		μA
$V_{1\text{PB8DIG}}$ (LDO Disabled)			10		μA
Turn On Time ⁶	2 g range Power-off to standby		<10 <10		ms ms

Parameter	Test Conditions/Comments	Min	Typ	Max	Unit
OUTPUT AMPLIFIER					
Swing	No load	0.03		$V_{IPBANA} - 0.03$	V
Output Series Resistance			32		k Ω
TEMPERATURE SENSOR					
Output at 25°C			892.2		mV
Scale Factor			3.0		mV/°C
TEMPERATURE					
Operating Temperature Range		-40		+125	°C

¹ The resonant frequency is a sensor characteristic. An integrated analog 1.5 kHz (-6 dB) sinc low-pass filter that cannot be bypassed limits the actual output response.

² The temperature change is -40°C to +25°C or +25°C to +125°C.

³ Repeatability is predicted for a 10 year life and includes shifts due to the high temperature operating life test (HTOL) ($T_A = 150^\circ\text{C}$, $V_{SUPPLY} = 3.6\text{ V}$, and 1000 hours), temperature cycling (-55°C to +125°C and 1000 cycles), velocity random walk, broadband noise, and temperature hysteresis.

⁴ The VRE measurement is the shift in dc offset while the device is subject to 2.5 g rms of random vibration from 50 Hz to 2 kHz. The device under test (DUT) is configured for the $\pm 2\text{ g}$ range and an output data rate of 4 kHz. The VRE scales with the range setting.

⁵ When V_{IPBANA} and V_{IPBDIG} are generated internally, V_{SUPPLY} is valid. To disable the LDO and drive V_{IPBANA} and V_{IPBDIG} externally, connect V_{SUPPLY} to V_{SS} .

⁶ Standby to measurement mode; valid when the output is within 1 mg of the final value.

DIGITAL OUTPUT FOR THE ADXL355

$T_A = 25^\circ\text{C}$, $V_{SUPPLY} = 3.3\text{ V}$, x-axis acceleration and y-axis acceleration = 0 g, and z-axis acceleration = 1 g, and output data rate (ODR) = 500 Hz, unless otherwise noted. Note that multifunction pin names may be referenced by their relevant function only.

Table 2.

Parameter	Test Conditions/Comments	Min	Typ	Max	Unit
SENSOR INPUT					
Output Full Scale Range (FSR)	Each axis User selectable		± 2.048 ± 4.096 ± 8.192		g
Nonlinearity	$\pm 2\text{ g}$		0.1		% FS
Cross Axis Sensitivity			1		%
SENSITIVITY					
X-Axis, Y-Axis, and Z-Axis Sensitivity	Each axis $\pm 2\text{ g}$ $\pm 4\text{ g}$ $\pm 8\text{ g}$	235,520 117,760 58,880	256,000 128,000 64,000	276,480 138,240 69,120	LSB/g
X-Axis, Y-Axis, and Z-Axis Scale Factor	$\pm 2\text{ g}$ $\pm 4\text{ g}$ $\pm 8\text{ g}$		3.9 7.8 15.6		$\mu\text{g}/\text{LSB}$
Sensitivity Change due to Temperature	-40°C to +125°C		± 0.01		%/°C
0 g OFFSET					
X-Axis, Y-Axis, and Z-Axis 0 g Output	Each axis, $\pm 2\text{ g}$	-75	± 25	+75	mg
0 g Offset vs. Temperature (X-Axis, Y-Axis, and Z-Axis) ¹	-40°C to +125°C	-0.15	± 0.02	+0.15	mg/°C
Repeatability ²	X-axis and y-axis Z-axis		± 3.5 ± 9		mg
Vibration Rectification ³	$\pm 2\text{ g}$ range, in a 1 g orientation, offset due to 2.5 g rms vibration		<0.4		g
NOISE DENSITY					
X-Axis, Y-Axis, and Z-Axis	$\pm 2\text{ g}$		25		$\mu\text{g}/\sqrt{\text{Hz}}$
Velocity Random Walk	X-axis and y-axis Z-axis		9 13		$\mu\text{m}/\text{sec}/\sqrt{\text{Hr}}$
OUTPUT DATA RATE AND BANDWIDTH					
Low-Pass Filter Passband Frequency	User programmable, Register 0x28	1		1000	Hz
High-Pass Filter Passband Frequency When Enabled (Disabled by Default)	User programmable, Register 0x28 for 4 kHz ODR	0.0095		10	Hz

Parameter	Test Conditions/Comments	Min	Typ	Max	Unit
SELF TEST					
Output Change					
X-Axis			0.3		g
Y-Axis			0.3		g
Z-Axis			1.5		g
POWER SUPPLY					
Voltage Range					
V_{SUPPLY} Operating ⁴		2.25	2.5	3.6	V
V_{DDIO}		V_{1P8DIG}	2.5	3.6	V
V_{1P8ANA} and V_{1P8DIG} with Internal LDO Bypassed	$V_{\text{SUPPLY}} = 0\text{ V}$	1.62	1.8	1.98	V
Current					
Measurement Mode					
V_{SUPPLY} (LDO Enabled)			200		μA
V_{1P8ANA} (LDO Disabled)			160		μA
V_{1P8DIG} (LDO Disabled)			35.5		μA
Standby Mode					
V_{SUPPLY} (LDO Enabled)			21		μA
V_{1P8ANA} (LDO Disabled)			7		μA
V_{1P8DIG} (LDO Disabled)			10		μA
Turn On Time ⁵	2 g range Power-off to standby		<10 <10		ms ms
TEMPERATURE SENSOR					
Output at 25°C			1852		LSB
Scale Factor			-9.05		LSB/°C
TEMPERATURE					
Operating Temperature Range		-40		+125	°C

¹ The temperature change is -40°C to +25°C or +25°C to +125°C.

² Repeatability is predicted for a 10 year life and includes shifts due to the HTOL ($T_A = 150^\circ\text{C}$, $V_{\text{SUPPLY}} = 3.6\text{ V}$, and 1000 hours), temperature cycling (-55°C to +125°C and 1000 cycles), velocity random walk, broadband noise, and temperature hysteresis.

³ The VRE measurement is the shift in dc offset while the device is subject to 2.5 g rms random vibration from 50 Hz to 2 kHz. The DUT is configured for the $\pm 2\text{ g}$ range and an output data rate of 4 kHz. The VRE scales with the range setting.

⁴ When V_{1P8ANA} and V_{1P8DIG} are generated internally, V_{SUPPLY} is valid. To disable the LDO and drive V_{1P8ANA} and V_{1P8DIG} externally, connect V_{SUPPLY} to V_{SS} .

⁵ Standby to measurement mode; valid when the output is within 1 mg of final value.

SPI DIGITAL INTERFACE CHARACTERISTICS FOR THE ADXL355

Note that multifunction pin names may be referenced by their relevant function only.

Table 3.

Parameter	Symbol	Test Conditions/Comments	Min	Typ	Max	Unit
DC INPUT LEVELS						
Input Voltage						
Low Level	V_{IL}				$0.3 \times V_{\text{DDIO}}$	V
High Level	V_{IH}		$0.7 \times V_{\text{DDIO}}$			V
Input Current						
Low Level	I_{IL}	$V_{\text{IN}} = 0\text{ V}$	-0.1			μA
High Level	I_{IH}	$V_{\text{IN}} = V_{\text{DDIO}}$			0.1	μA
DC OUTPUT LEVELS						
Output Voltage						
Low Level	V_{OL}	$I_{\text{OL}} = I_{\text{OL, MIN}}$			$0.2 \times V_{\text{DDIO}}$	V
High Level	V_{OH}	$I_{\text{OH}} = I_{\text{OH, MAX}}$	$0.8 \times V_{\text{DDIO}}$			V
Output Current						
Low Level	I_{OL}	$V_{\text{OL}} = V_{\text{OL, MAX}}$	-10			mA
High Level	I_{OH}	$V_{\text{OH}} = V_{\text{OH, MIN}}$			4	mA

Parameter	Symbol	Test Conditions/Comments	Min	Typ	Max	Unit
AC INPUT LEVELS						
SCLK Frequency			0.1		10	MHz
SCLK High Time	t_{HIGH}		40			ns
SCLK Low Time	t_{LOW}		40			ns
\overline{CS} Setup Time	t_{CSS}		20			ns
\overline{CS} Hold Time	t_{CSH}		20			ns
\overline{CS} Disable Time	t_{CSD}		40			ns
Rising SCLK Setup Time	t_{SCLKS}		20			ns
MOSI Setup Time	t_{SU}		20			ns
MOSI Hold Time	t_{HD}		20			ns
AC OUTPUT LEVELS						
Propagation Delay	t_P	$C_{LOAD} = 30 \text{ pF}$			30	ns
Enable MISO Time	t_{EN}		30			ns
Disable MISO Time	t_{DIS}				20	ns

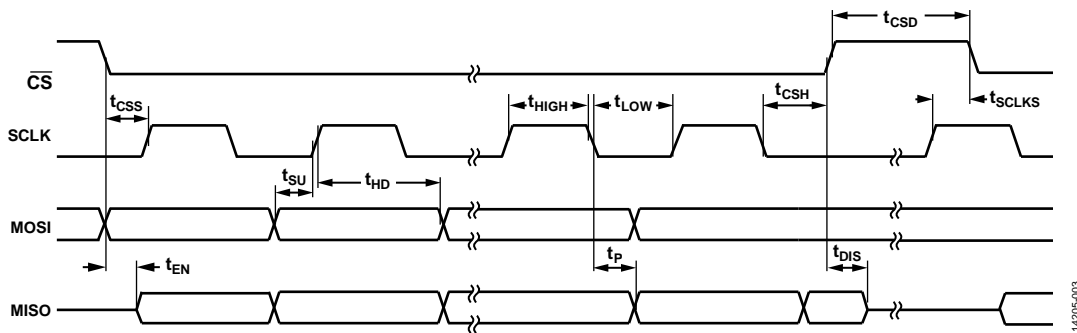

Figure 3. SPI Interface Timing Diagram

I²C DIGITAL INTERFACE CHARACTERISTICS FOR THE ADXL355

Note that multifunction pin names may be referenced by their relevant function only.

Table 4.

Parameter	Symbol	Test Conditions/ Comments	I2C_HS = 0 (Fast Mode)			I2C_HS = 1 (High Speed Mode)			Unit
			Min	Typ	Max	Min	Typ	Max	
DC INPUT LEVELS									
Input Voltage									
Low Level	V_{IL}				$0.3 \times V_{DDIO}$		$0.3 \times V_{DDIO}$	V	
High Level	V_{IH}		$0.7 \times V_{DDIO}$			$0.7 \times V_{DDIO}$		V	
Hysteresis of Schmitt Trigger Inputs	V_{HYS}		$0.05 \times V_{DDIO}$			$0.1 \times V_{DDIO}$		μA	
Input Current	I_{IL}	$0.1 \times V_{DDIO} < V_{IN} < 0.9 \times V_{DDIO}$	-10		+10			μA	
DC OUTPUT LEVELS									
Output Voltage									
Low Level	V_{OL1} V_{OL2}	$I_{OL} = 3 \text{ mA}$ $V_{DD} > 2 \text{ V}$ $V_{DD} \leq 2 \text{ V}$			0.4 $0.2 \times V_{DDIO}$			V V	
Output Current									
Low Level	I_{OL}	$V_{OL} = 0.4 \text{ V}$ $V_{OL} = 0.6 \text{ V}$	20 6					mA mA	

Parameter	Symbol	Test Conditions/ Comments	I2C_HS = 0 (Fast Mode)			I2C_HS = 1 (High Speed Mode)			Unit
			Min	Typ	Max	Min	Typ	Max	
AC INPUT LEVELS									
SCLK Frequency			0		1	0		3.4	MHz
SCL High Time	t _{HIGH}		260			60			ns
SCL Low Time	t _{LOW}		500			160			ns
Start Setup Time	t _{SUSTA}		260			160			ns
Start Hold Time	t _{HDSTA}		260			160			ns
SDA Setup Time	t _{SUDAT}		50			10			ns
SDA Hold Time	t _{HDDAT}		0			0			ns
Stop Setup Time	t _{SUSTO}		260			160			ns
Bus Free Time	t _{BUF}		500						ns
SCL Input Rise Time	t _{RCL}				120			80	ns
SCL Input Fall Time	t _{FCL}				120			80	ns
SDA Input Rise Time	t _{RDA}				120			160	ns
SDA Input Fall Time	t _{FDA}				120			160	ns
Width of Spikes to Suppress	t _{SP}	Not shown in Figure 4			50			10	ns
AC OUTPUT LEVELS									
Propagation Delay Data	t _{VDDAT}	C _{LOAD} = 500 pF	97		450	27		135	ns
Acknowledge	t _{VDACK}				450				ns
Output Fall Time	t _F	Not shown in Figure 4	20 × (V _{DD} /5.5)		120				ns

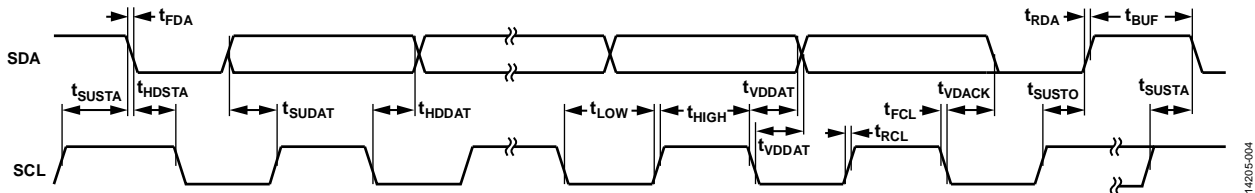

Figure 4. I²C Interface Timing Diagram

14205-004

ABSOLUTE MAXIMUM RATINGS

Table 5.

Parameter	Rating
Acceleration (Any Axis, 0.1 ms) Unpowered	5,000 g
Vibration	Per MIL-STD-883 Method 2007, Test Condition A
V_{SUPPLY} , V_{DDIO}	5.4 V
V_{IP8ANA} , V_{IP8DIG} Configured as Inputs	1.98 V
ADXL354 Digital Inputs (RANGE, ST1, ST2, STBY)	-0.3 V to $V_{\text{DDIO}} + 0.3$ V
Analog Outputs (X_{OUT} , Y_{OUT} , Z_{OUT} , TEMP)	-0.3 V to $V_{\text{IP8ANA}} + 0.3$ V
ADXL355 Digital Pins ($\overline{\text{CS}}$, SCLK, MOSI, MISO, INT1, INT2, DRDY)	-0.3 V to $V_{\text{DDIO}} + 0.3$ V
Operating Temperature Range	-40°C to +125°C
Storage Temperature Range	-55°C to +150°C

Stresses at or above those listed under Absolute Maximum Ratings may cause permanent damage to the product. This is a stress rating only; functional operation of the product at these or any other conditions above those indicated in the operational section of this specification is not implied. Operation beyond

the maximum operating conditions for extended periods may affect product reliability.

THERMAL RESISTANCE

Thermal performance is directly linked to printed circuit board (PCB) design and operating environment. Careful attention to PCB thermal design is required.

Table 6. Thermal Resistance

Package Type	θ_{JA}	Unit
E-14-1 ¹	42	°C/W

¹ Thermal impedance simulated values are based on a JEDEC 252P thermal test board with four thermal vias. See JEDEC JESD51.

ESD CAUTION



ESD (electrostatic discharge) sensitive device. Charged devices and circuit boards can discharge without detection. Although this product features patented or proprietary protection circuitry, damage may occur on devices subjected to high energy ESD. Therefore, proper ESD precautions should be taken to avoid performance degradation or loss of functionality.

PIN CONFIGURATIONS AND FUNCTION DESCRIPTIONS

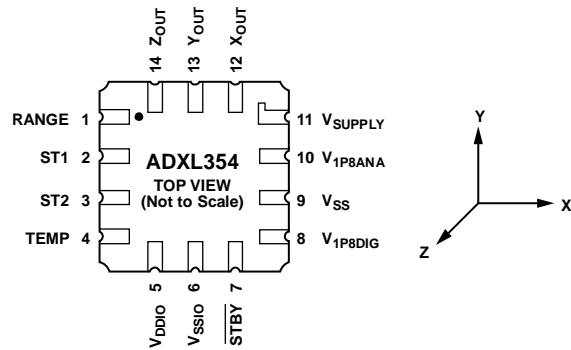

Figure 5. ADXL354 Pin Configuration

Table 7. ADXL354 Pin Function Descriptions

Pin No.	Mnemonic	Description
1	RANGE	Range Selection Pin. Set this pin to ground to select the $\pm 2 g$ range, or set this pin to V_{DDIO} to select the $\pm 4 g$ or $\pm 8 g$ range. This pin is model dependent (see the Ordering Guide section).
2	ST1	Self Test Pin 1. This pin enables self test mode.
3	ST2	Self Test Pin 2. This pin activates the electromechanical self test actuation.
4	TEMP	Temperature Sensor Output.
5	V_{DDIO}	Digital Interface Supply Voltage.
6	V_{SSIO}	Digital Ground.
7	\overline{STBY}	Standby or Measurement Mode Selection Pin. Set this pin to ground to enter standby mode, or set this pin to V_{DDIO} to enter measurement mode.
8	V_{1P8DIG}	Digital Supply. This pin requires a decoupling capacitor. If V_{SUPPLY} connects to V_{SS} , supply the voltage to this pin externally.
9	V_{SS}	Analog Ground.
10	V_{1P8ANA}	Analog Supply. This pin requires a decoupling capacitor. If V_{SUPPLY} connects to V_{SS} , supply the voltage to this pin externally.
11	V_{SUPPLY}	Supply Voltage. When V_{SUPPLY} equals 2.25 V to 3.6 V, V_{SUPPLY} enables the internal LDOs to generate V_{1P8DIG} and V_{1P8ANA} . For $V_{SUPPLY} = V_{SS}$, V_{1P8DIG} and V_{1P8ANA} are externally supplied.
12	X_{OUT}	X-Axis Output.
13	Y_{OUT}	Y-Axis Output.
14	Z_{OUT}	Z-Axis Output.

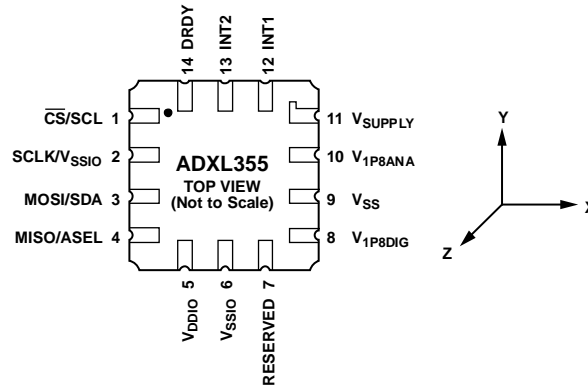

Figure 6. ADXL355 Pin Configuration

142205-008

Table 8. ADXL355 Pin Function Descriptions

Pin No.	Mnemonic	Description
1	CS/SCL	Chip Select for SPI (CS). Serial Communications Clock for I ² C (SCL).
2	SCLK/VSSIO	Serial Communications Clock for SPI (SCLK). Connect to VSSIO for I ² C (VSSIO).
3	MOSI/SDA	Master Output, Slave Input for SPI (MOSI). Serial Data for I ² C (SDA).
4	MISO/ASEL	Master Input, Slave Output for SPI (MISO). Alternate I ² C Address Select for I ² C (ASEL).
5	VDDIO	Digital Interface Supply Voltage.
6	VSSIO	Digital Ground.
7	RESERVED	Reserved. This pin can be connected to ground or left open.
8	V1P8DIG	Digital Supply. This pin requires a decoupling capacitor. If VSUPPLY connects to VSS, supply the voltage to this pin externally.
9	VSS	Analog Ground.
10	V1P8ANA	Analog Supply. This pin requires a decoupling capacitor. If VSUPPLY connects to VSS, supply the voltage to this pin externally.
11	VSUPPLY	Supply Voltage. When VSUPPLY equals 2.25 V to 3.6 V, VSUPPLY enables the internal LDOs to generate V1P8DIG and V1P8ANA. For VSUPPLY = VSS, V1P8DIG and V1P8ANA are externally supplied.
12	INT1	Interrupt Pin 1.
13	INT2	Interrupt Pin 2.
14	DRDY	Data Ready Pin.

TYPICAL PERFORMANCE CHARACTERISTICS

All figures include data for multiple devices and multiple lots, and they were taken in the $\pm 2 g$ range, unless otherwise noted.

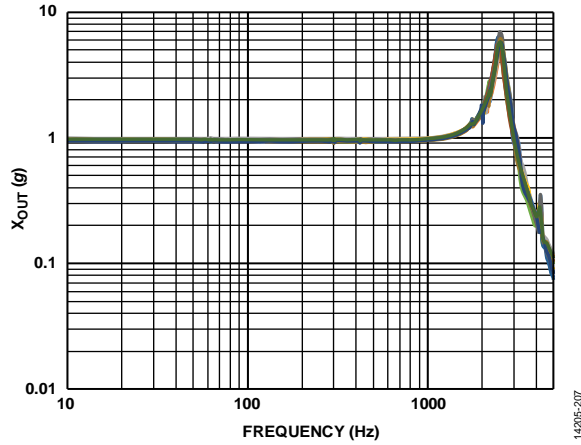

Figure 7. ADXL354 Frequency Response for X-Axis

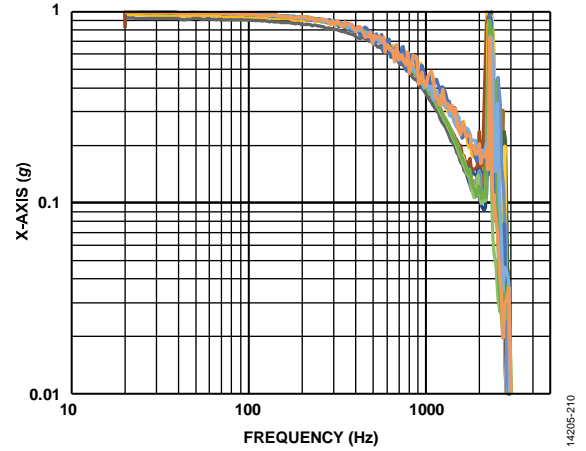

Figure 10. ADXL355 Normalized Frequency Response for X-Axis at 4 kHz ODR

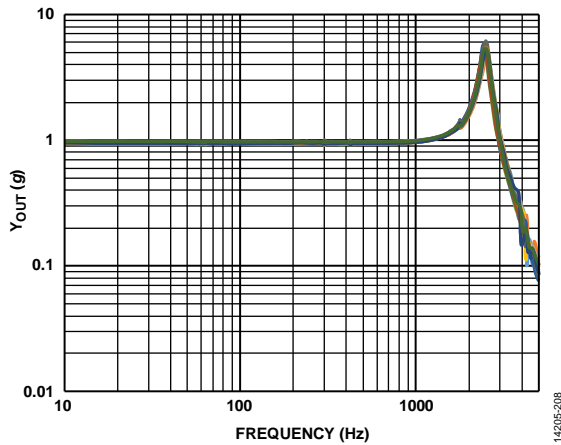

Figure 8. ADXL354 Frequency Response for Y-Axis

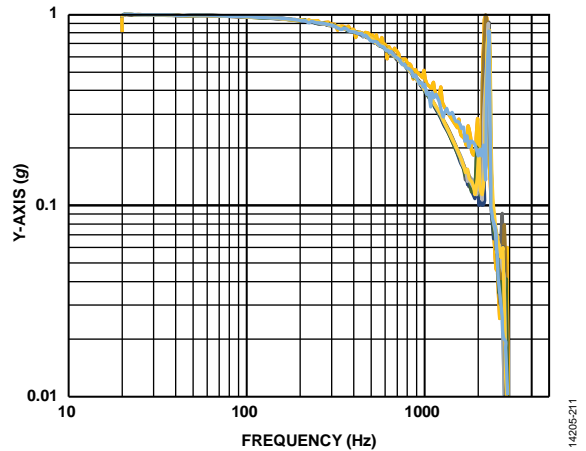

Figure 11. ADXL355 Normalized Frequency Response for Y-Axis at 4 kHz ODR

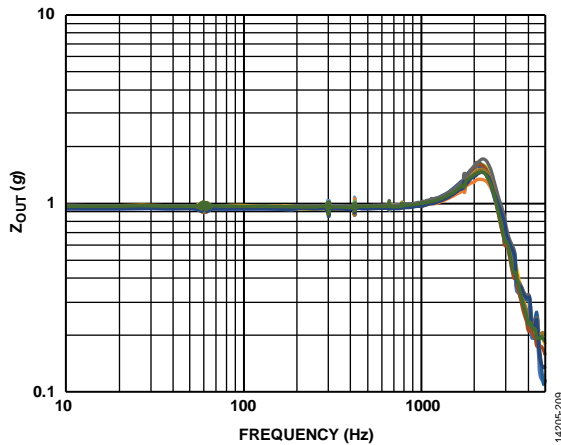

Figure 9. ADXL354 Frequency Response for Z-Axis

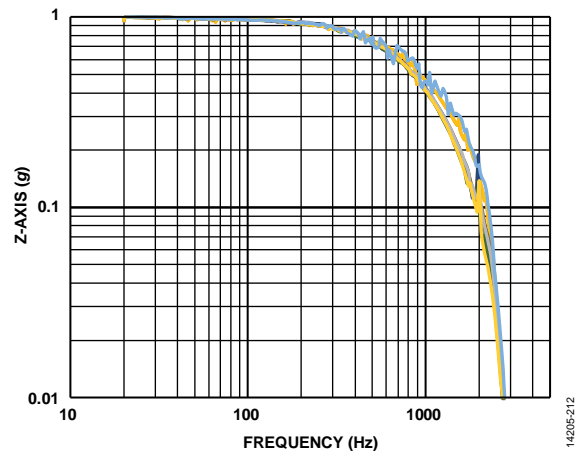

Figure 12. ADXL355 Normalized Frequency Response for Z-Axis at 4 kHz ODR

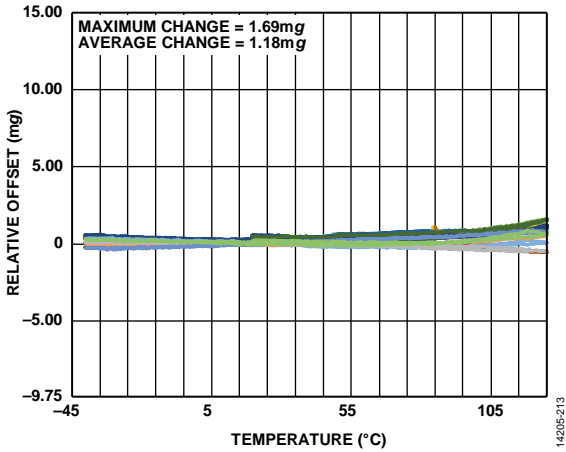

Figure 13. ADXL354 X-Axis Zero g Offset Relative to 25°C vs. Temperature

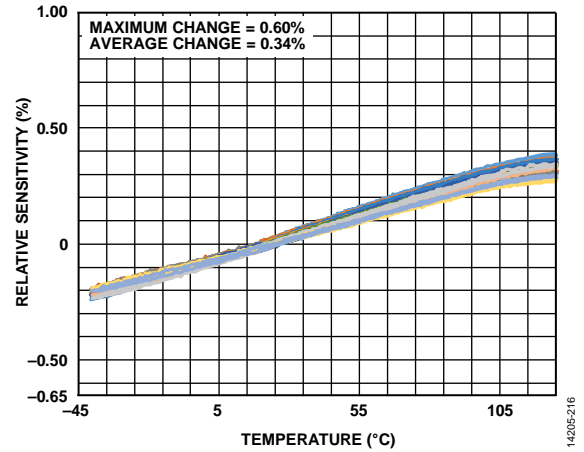

Figure 16. ADXL354 X-Axis Sensitivity Relative to 25°C vs. Temperature

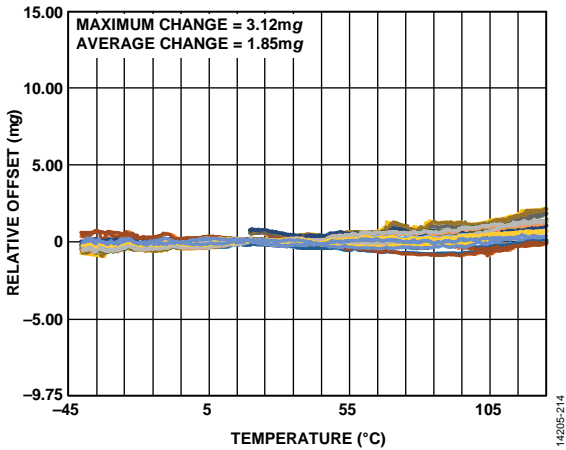

Figure 14. ADXL354 Y-Axis Zero g Offset Relative to 25°C vs. Temperature

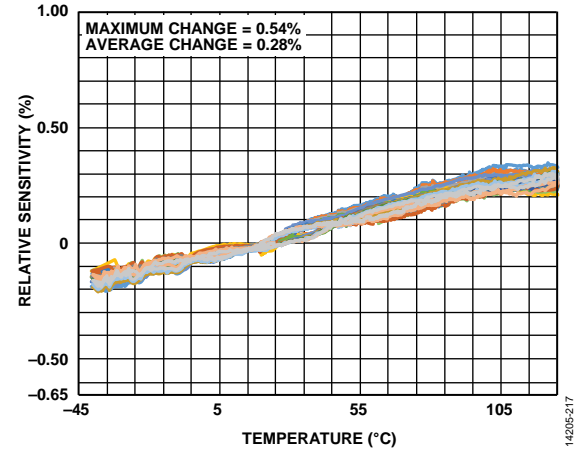

Figure 17. ADXL354 Y-Axis Sensitivity Relative to 25°C vs. Temperature

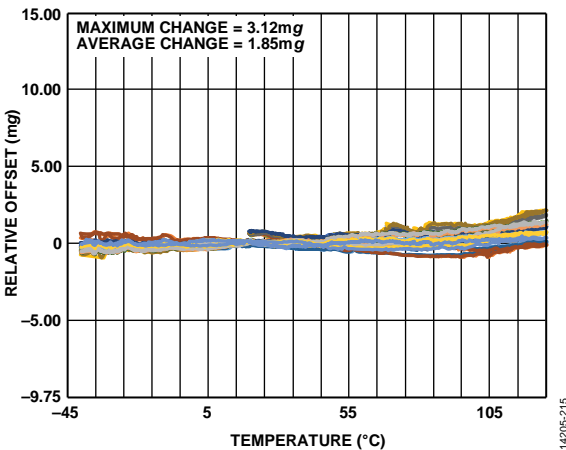

Figure 15. ADXL354 Z-Axis Zero g Offset Relative to 25°C vs. Temperature

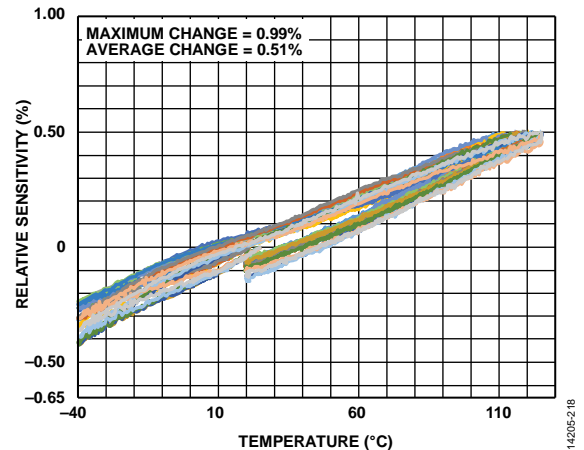

Figure 18. ADXL354 Z-Axis Sensitivity Relative to 25°C vs. Temperature

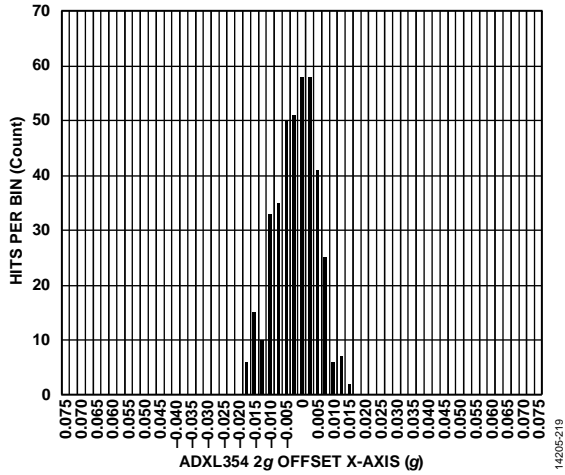

Figure 19. ADXL354 Zero g Offset Histogram at 25°C, X-Axis

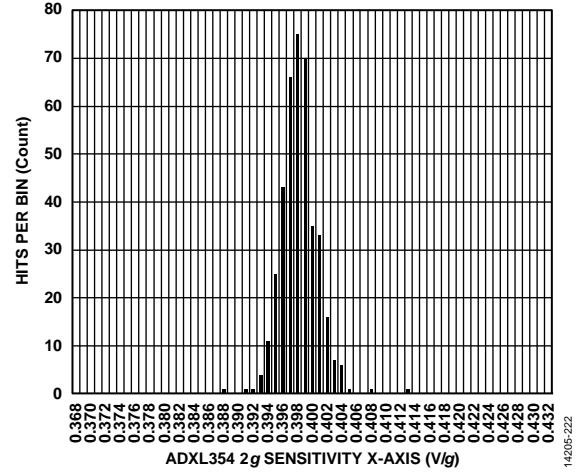

Figure 22. ADXL354 Sensitivity Histogram at 25°C, X-Axis

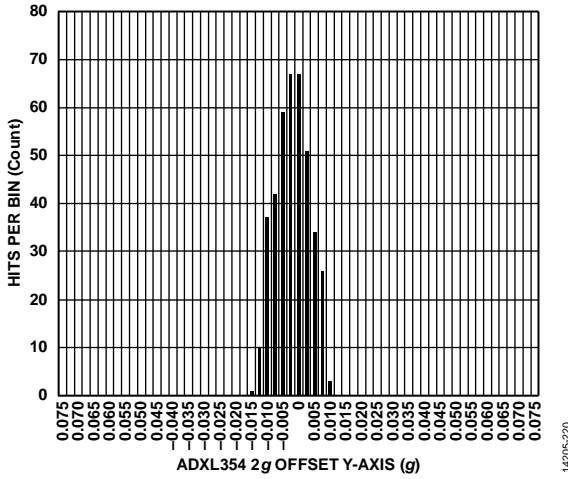

Figure 20. ADXL354 Zero g Offset Histogram at 25°C, Y-Axis

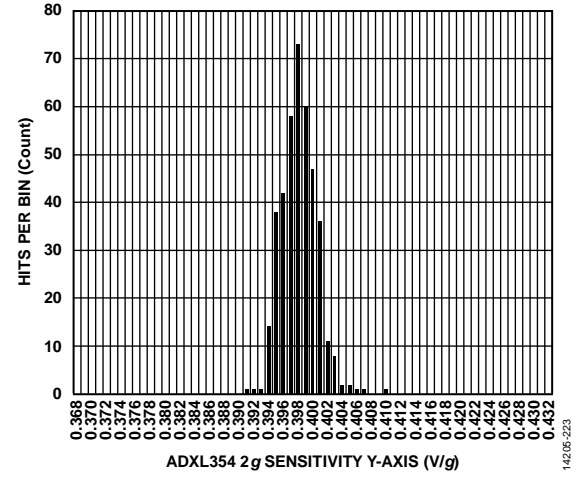

Figure 23. ADXL354 Sensitivity Histogram at 25°C, Y-Axis

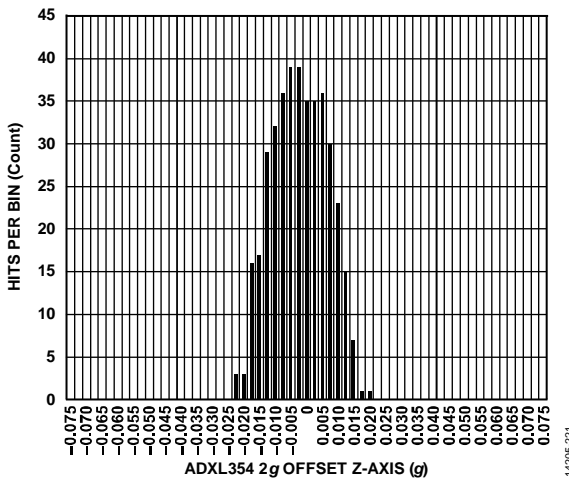

Figure 21. ADXL354 Zero g Offset Histogram at 25°C, Z-Axis

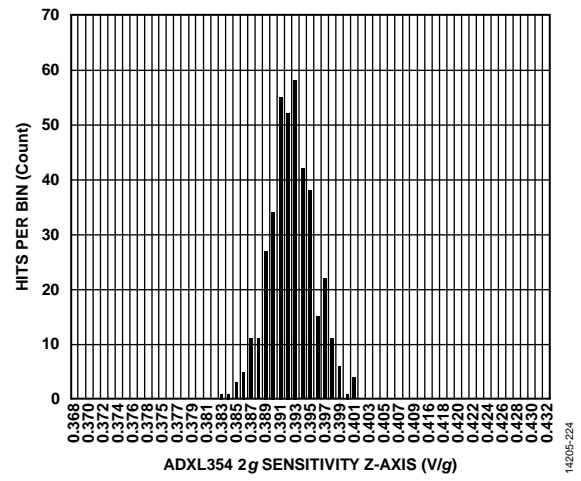

Figure 24. ADXL354 Sensitivity Histogram at 25°C, Z-Axis

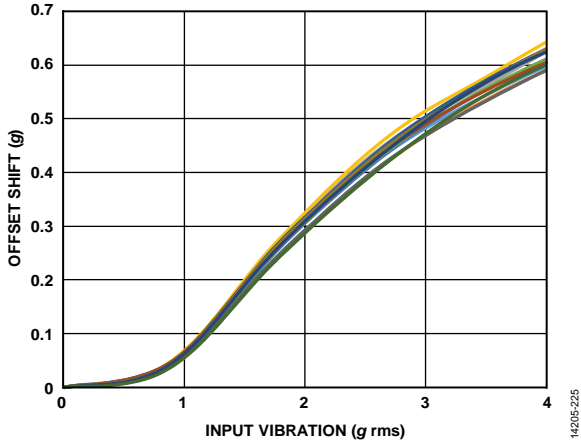

Figure 25. ADXL354 Vibration Rectification Error (VRE), X-Axis Offset from +1 g, ±2 g Range, X-Axis Orientation = -1 g

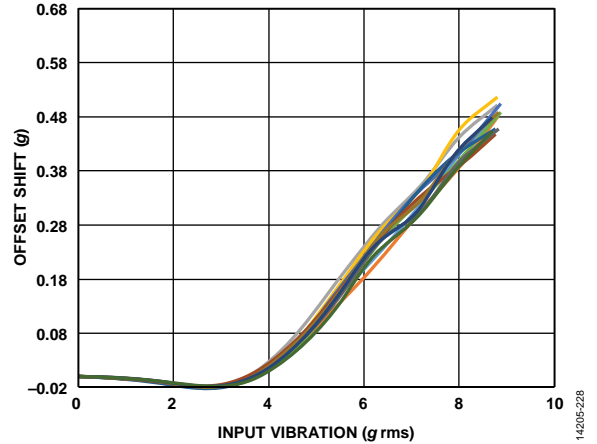

Figure 28. ADXL354 Vibration Rectification Error (VRE), X-Axis Offset from +1 g, ±8 g Range, X-Axis Orientation = -1 g

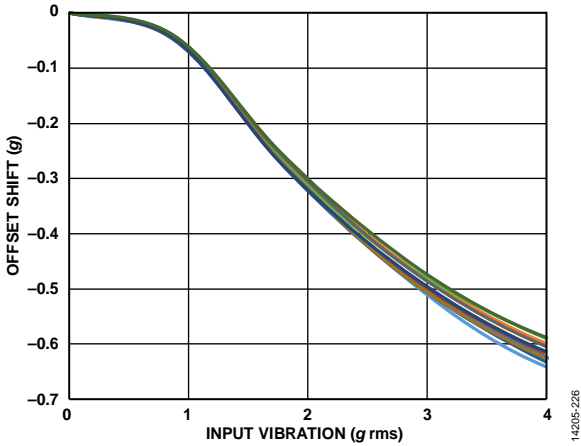

Figure 26. ADXL354 Vibration Rectification Error (VRE), Y-Axis Offset from +1 g, ±2 g Range, Y-Axis Orientation = +1 g

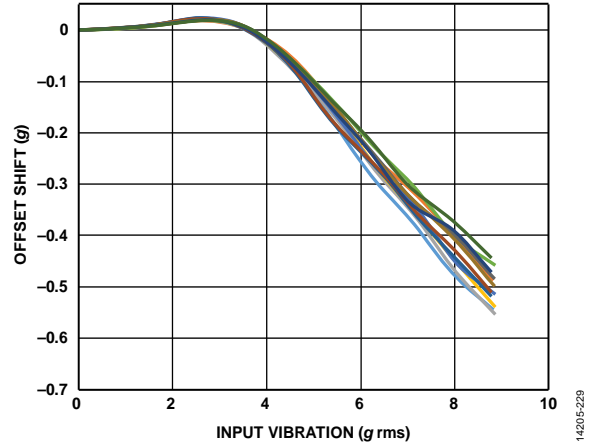

Figure 29. ADXL354 Vibration Rectification Error (VRE), Y-Axis Offset from +1 g, ±8 g Range, Y-Axis Orientation = +1 g

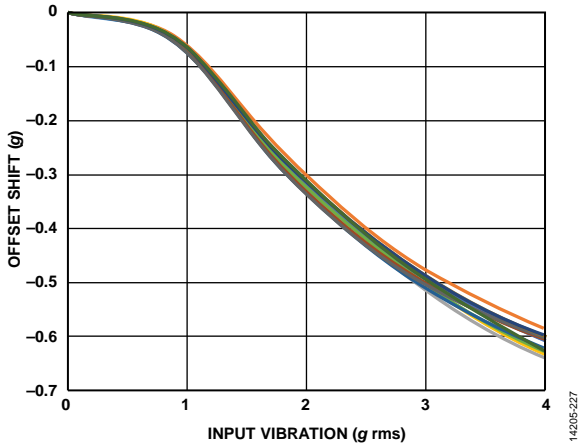

Figure 27. ADXL354 Vibration Rectification Error (VRE), Z-Axis Offset from +1 g, ±2 g Range, Z-Axis Orientation = +1 g

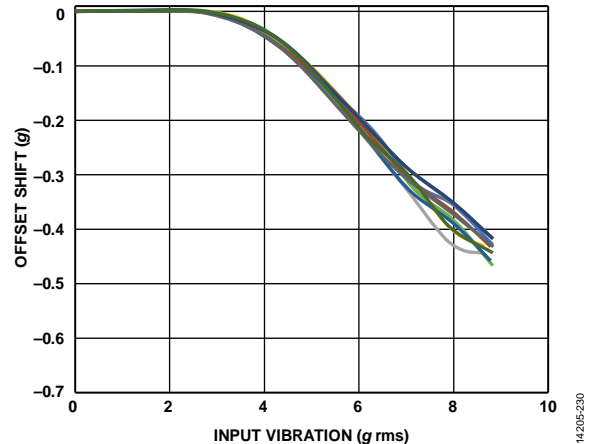

Figure 30. ADXL354 Vibration Rectification Error (VRE), Z-Axis Offset from +1 g, ±8 g Range, Z-Axis Orientation = +1 g

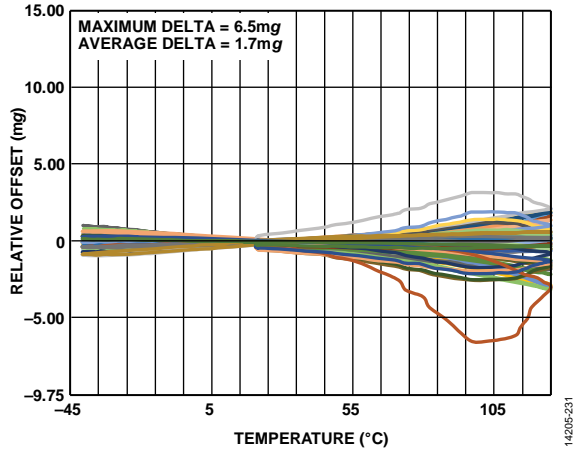

Figure 31. ADXL355 X-Axis Zero g Offset Relative to 25°C vs. Temperature

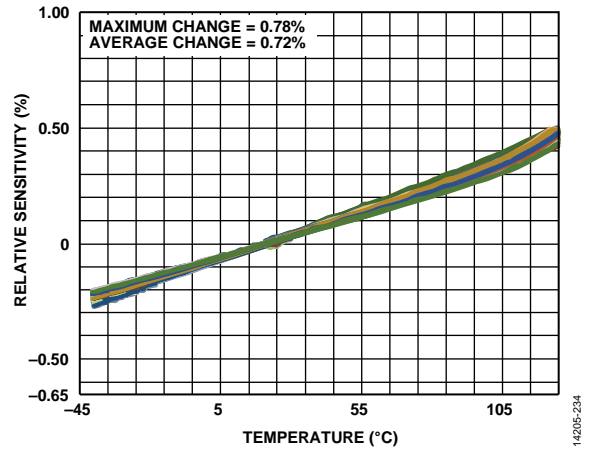

Figure 34. ADXL355 X-Axis Sensitivity Relative to 25°C vs. Temperature

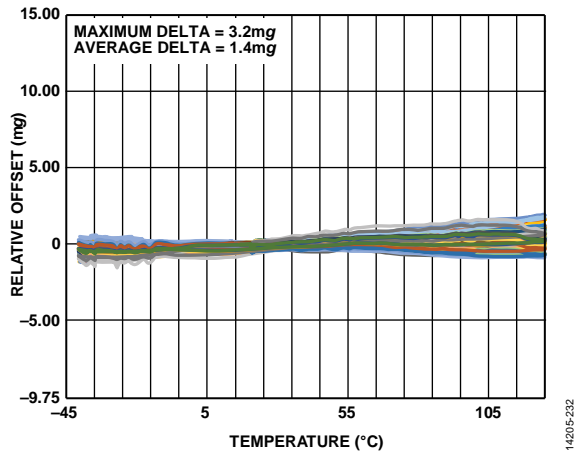

Figure 32. ADXL355 Y-Axis Zero g Offset Relative to 25°C vs. Temperature

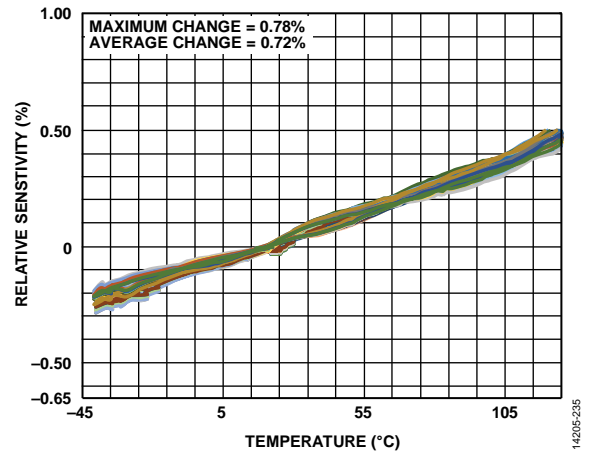

Figure 35. ADXL355 Y-Axis Sensitivity Relative to 25°C vs. Temperature

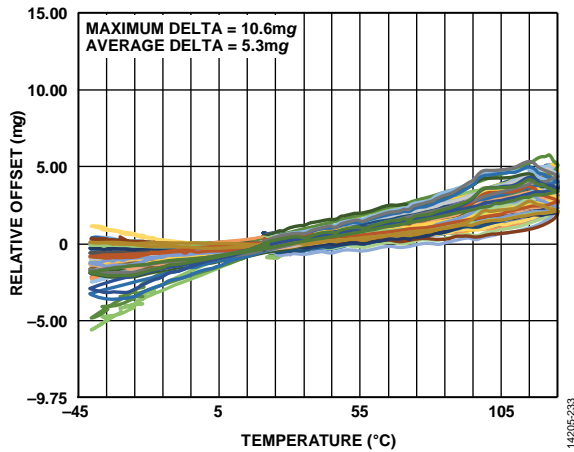

Figure 33. ADXL355 Z-Axis Zero g Offset Relative to 25°C vs. Temperature

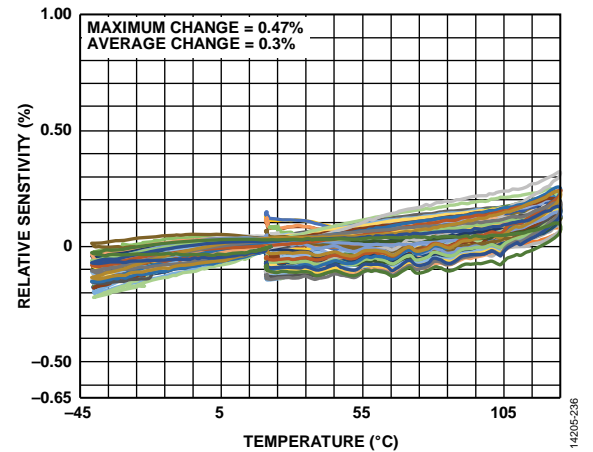

Figure 36. ADXL355 Z-Axis Sensitivity Relative to 25°C vs. Temperature

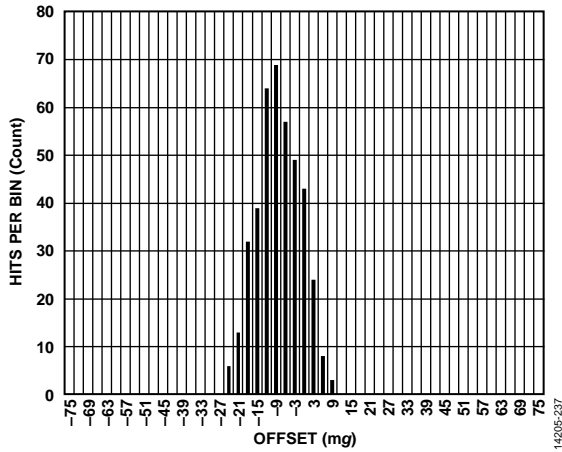

Figure 37. ADXL355 Zero g Offset Histogram at 25°C, X-Axis

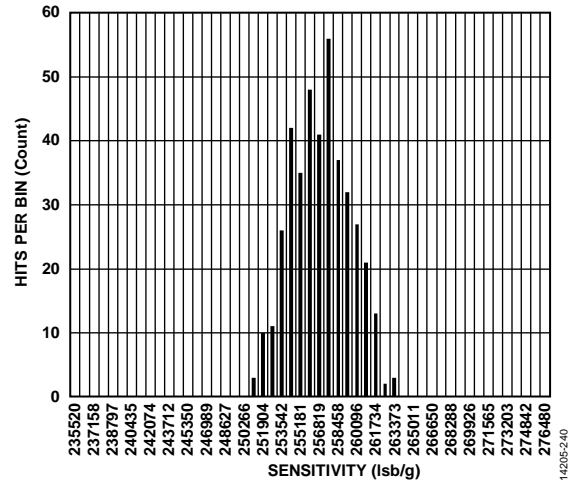

Figure 40. ADXL355 Sensitivity Histogram at 25°C, X-Axis

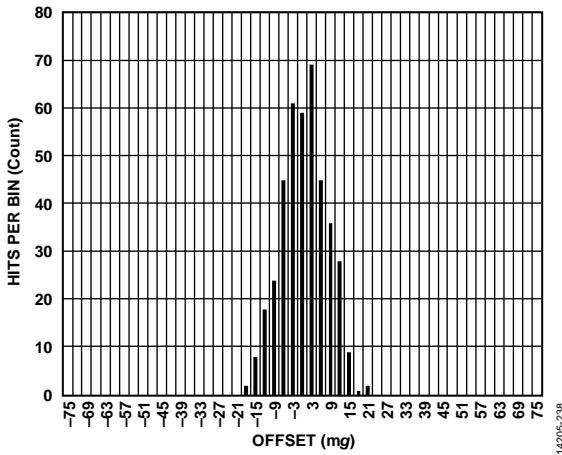

Figure 38. ADXL355 Zero g Offset Histogram at 25°C, Y-Axis

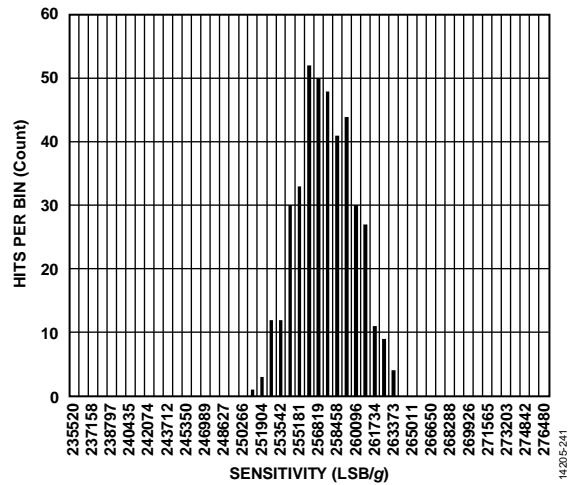

Figure 41. ADXL355 Sensitivity Histogram at 25°C, Y-Axis

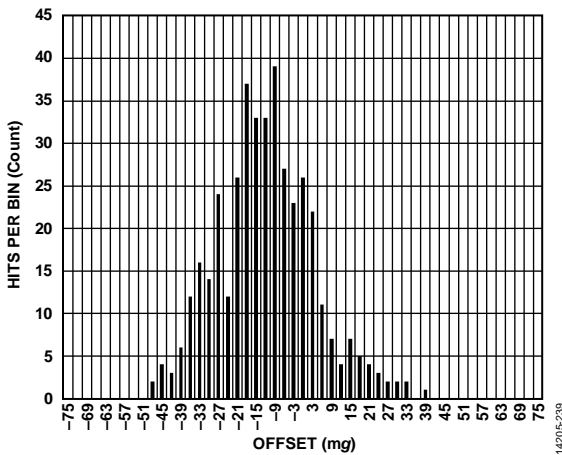

Figure 39. ADXL355 Zero g Offset Histogram at 25°C, Z-Axis

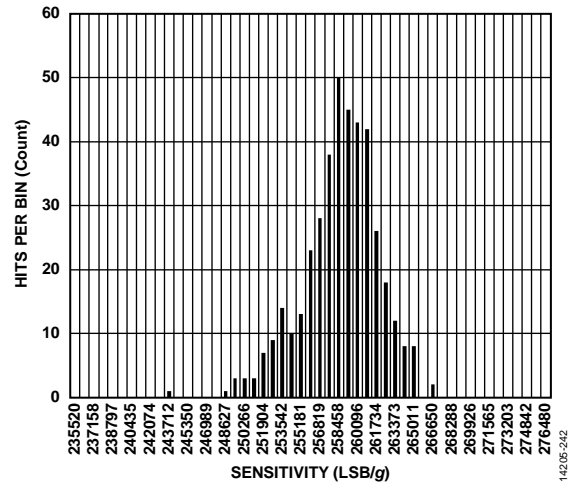

Figure 42. ADXL355 Sensitivity Histogram at 25°C, Z-Axis

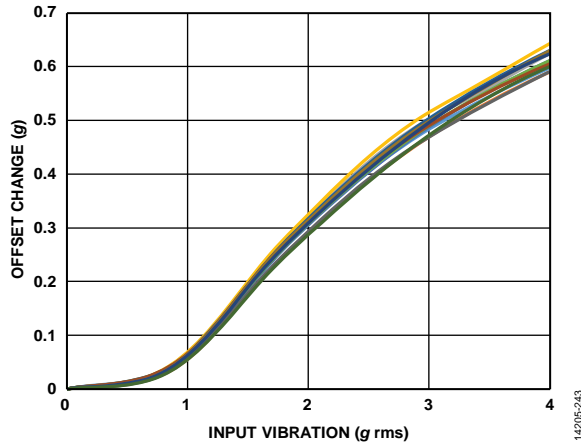

Figure 43. ADXL355 Vibration Rectification Error (VRE), X-Axis Offset from +1 g, ± 2 g Range, X-Axis Orientation = -1 g

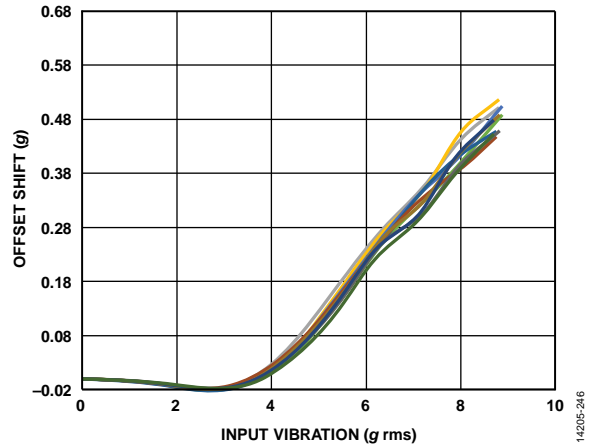

Figure 46. ADXL355 Vibration Rectification Error (VRE), X-Axis Offset from +1 g, ± 8 g Range, X-Axis Orientation = -1 g

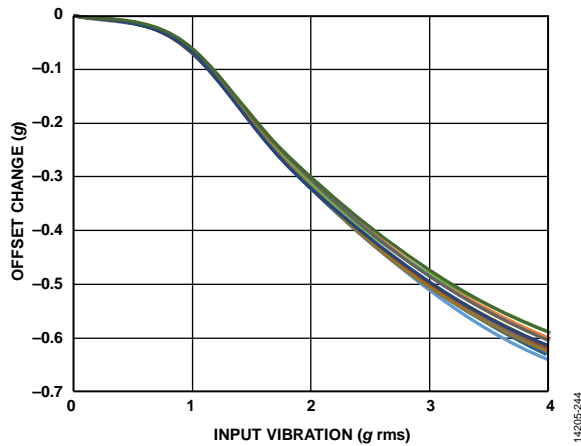

Figure 44. ADXL355 Vibration Rectification Error (VRE), Y-Axis Offset from +1 g, ± 2 g Range, Y-Axis Orientation = $+1$ g

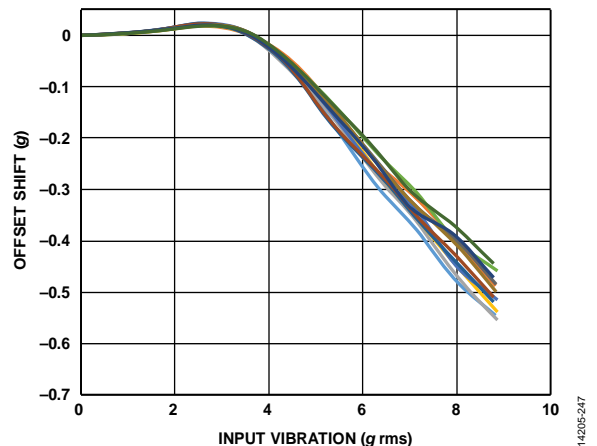

Figure 47. ADXL355 Vibration Rectification Error (VRE), Y-Axis Offset from +1 g, ± 8 g Range, Y-Axis Orientation = $+1$ g

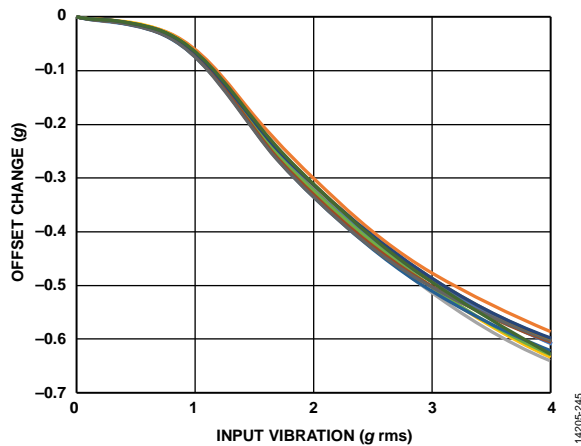

Figure 45. ADXL355 Vibration Rectification Error (VRE), Z-Axis Offset from +1 g, ± 2 g Range, Z-Axis Orientation = $+1$ g

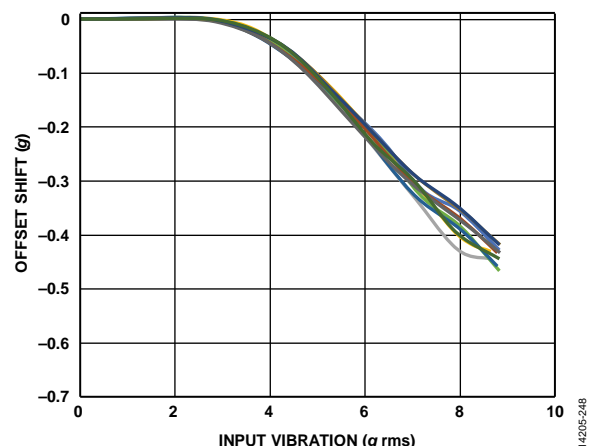

Figure 48. ADXL355 Vibration Rectification Error (VRE), Z-Axis Offset from +1 g, ± 8 g Range, Z-Axis Orientation = $+1$ g

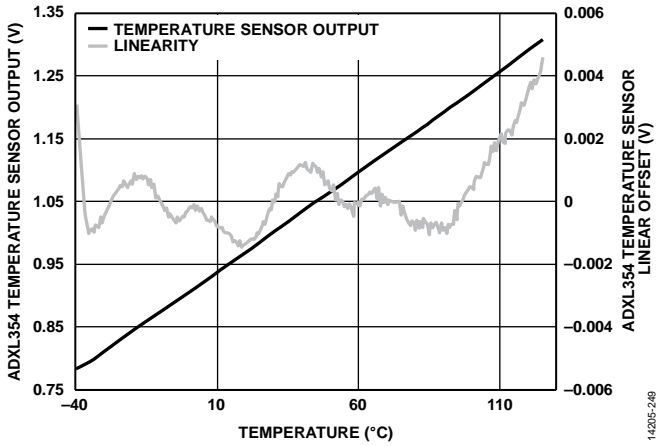

Figure 49. ADXL354 Temperature Sensor Output and Linearity Offset vs. Temperature

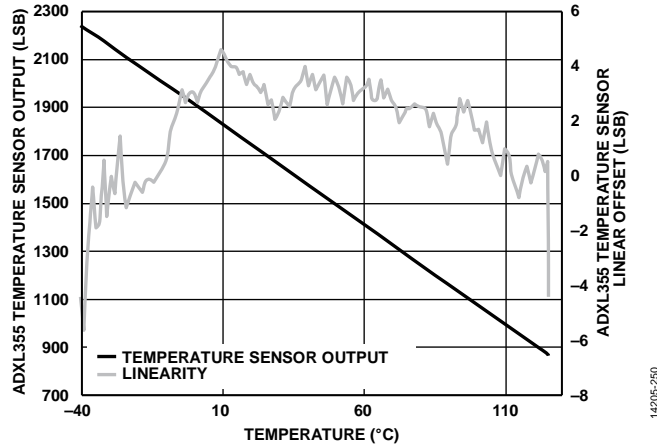

Figure 52. ADXL355 Temperature Sensor Output and Linearity Offset vs. Temperature

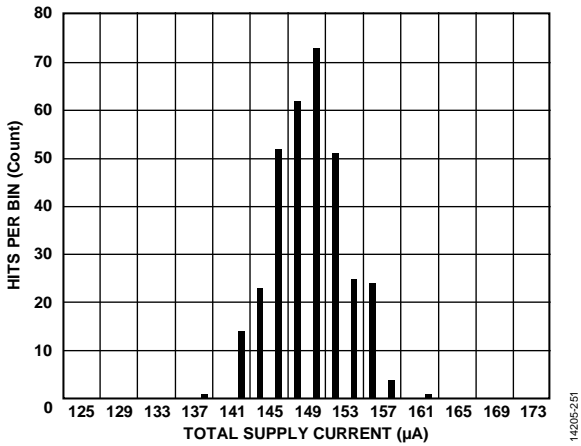

Figure 50. ADXL354 Total Supply Current, 3.3 V

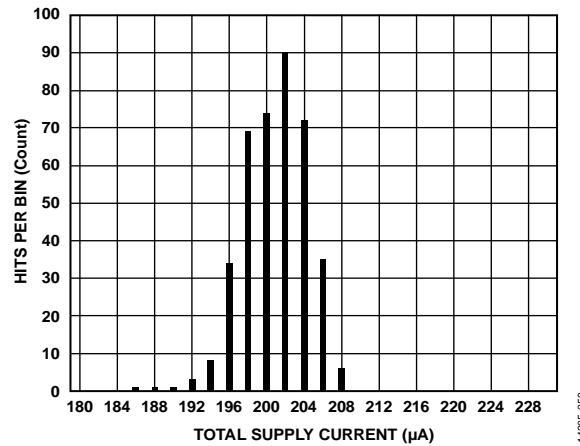

Figure 53. ADXL355 Total Supply Current, 3.3 V

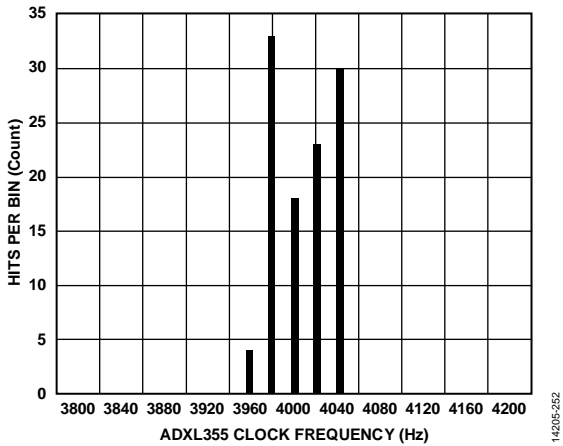

Figure 51. ADXL355 Internal Clock Frequency Histogram

ROOT ALLAN VARIANCE (RAV) ADXL355 CHARACTERISTICS

All figures include data for multiple devices and multiple lots, and they were taken in the ± 2 g range, unless otherwise noted.

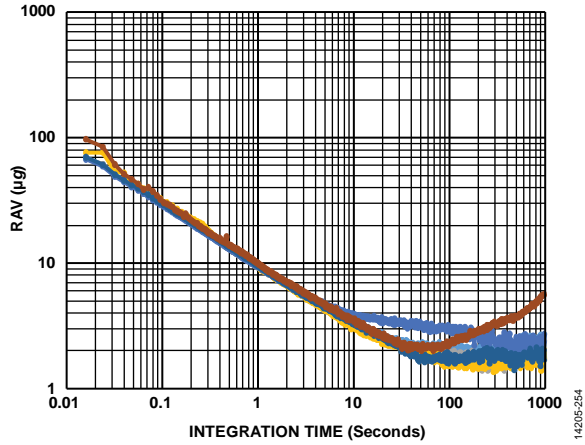

Figure 54. ADXL355 Root Allan Variance (RAV), X-Axis

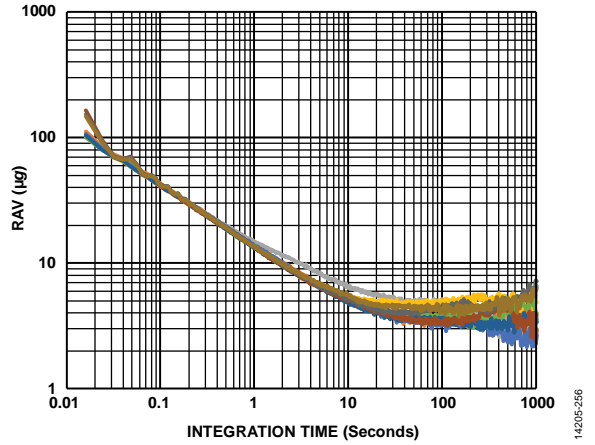

Figure 56. ADXL355 Root Allan Variance (RAV), Z-Axis

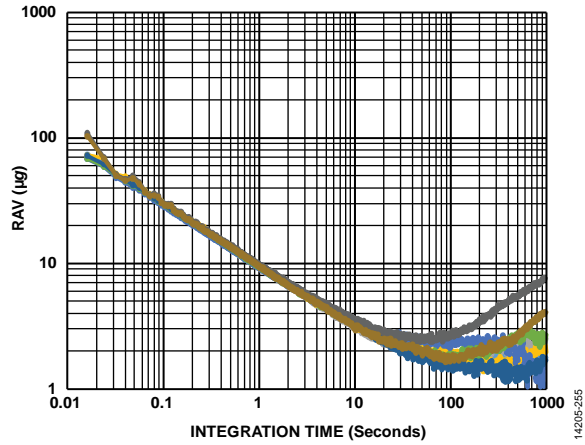

Figure 55. ADXL355 Root Allan Variance (RAV), Y-Axis

THEORY OF OPERATION

The **ADXL354** is a complete 3-axis, ultralow noise and ultrastable offset MEMS accelerometer with outputs ratiometric to the analog 1.8 V supply, V_{IP8ANA} . The **ADXL355** adds three high resolution ADCs that use the analog 1.8 V supply as a reference to provide digital outputs insensitive to the supply voltage. The **ADXL354B** is pin selectable for $\pm 2 g$ or $\pm 4 g$ full scale, the **ADXL354C** is pin selectable for $\pm 2 g$ or $\pm 8 g$ full scale, and the **ADXL355** is programmable for $\pm 2.048 g$, $\pm 4.096 g$, and $\pm 8.192 g$ full scale. The **ADXL355** offers both SPI and I²C communications ports.

The micromachined, sensing elements are fully differential, comprising the lateral x-axis and y-axis sensors and the vertical, teeter totter z-axis sensors. The x-axis and y-axis sensors and the z-axis sensors go through separate signal paths that minimize offset drift and noise. The signal path is fully differential, except for a differential to single-ended conversion at the analog outputs of the **ADXL354**.

The analog accelerometer outputs of the **ADXL354** are ratiometric to V_{IP8ANA} ; therefore, carefully digitize them correctly. The temperature sensor output is not ratiometric. The X_{OUT} , Y_{OUT} , and Z_{OUT} analog outputs are filtered internally with an anti-aliasing filter. These analog outputs also have an internal 32 k Ω series resistor that can be used with an external capacitor to set the bandwidth of the output.

The **ADXL355** includes antialias filters before and after the high resolution Σ - Δ ADC. User-selectable output data rates and filter corners are provided. The temperature sensor is digitized with a 12-bit successive approximation register (SAR) ADC.

ANALOG OUTPUT

Figure 57 shows the **ADXL354** application circuit. The analog outputs (X_{OUT} , Y_{OUT} , and Z_{OUT}) are ratiometric to the 1.8 V analog voltage from the V_{IP8ANA} pin. V_{IP8ANA} can be powered with an on-chip LDO that is powered from V_{SUPPLY} . V_{IP8ANA} can also be supplied externally by forcing V_{SUPPLY} to V_{SS} , which disables the LDO. Due to the ratiometric response, the analog output requires referencing to the V_{IP8ANA} supply when digitizing to achieve the inherent noise and offset performance of the **ADXL354**. The 0 g bias output is nominally equal to $V_{IP8ANA}/2$. The recommended option is to use the **ADXL354** with a ratiometric ADC (for example, the Analog Devices, Inc., **AD7682**) with V_{IP8ANA} providing the voltage reference. This configuration results in self cancellation of errors due to minor supply variations.

The **ADXL354** outputs two forms of filtering: internal anti-aliasing filtering with a cutoff frequency of approximately 1.5 kHz, and external filtering. The external filter uses a fixed, on-chip, 32 k Ω resistance in series with each output in conjunction with the external capacitors to implement the low-pass filter antialiasing and noise reduction prior to the external ADC. The antialias filter cutoff frequency must be significantly higher than the desired signal bandwidth. If the antialias filter corner is too low, ratiometricity can be degraded where the signal attenuation is different than the reference attenuation.

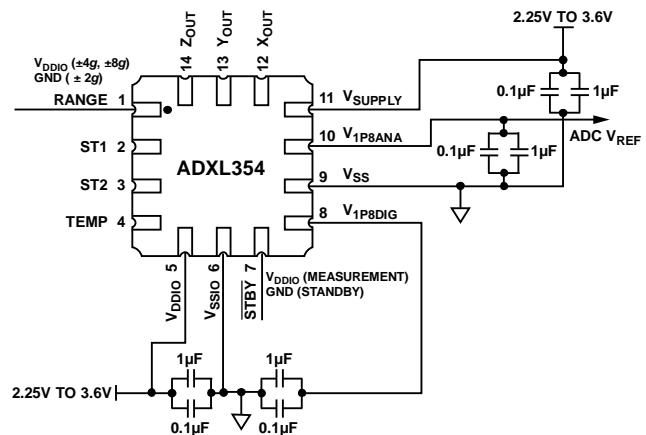

Figure 57. **ADXL354** Application Circuit

14205-022

DIGITAL OUTPUT

Figure 59 shows the ADXL355 application circuit with the recommended bypass capacitors. The communications interface is either SPI or I²C (see the Serial Communications section for additional information).

The ADXL355 includes an internal configurable digital band-pass filter. Both the high-pass and low-pass poles of the filter are adjustable, as detailed in the Filter Settings Register section and Table 43. At power-up, the default conditions for the filters are as follows:

- High-pass filter (HPF) = dc (off)
- Low-pass filter (LPF) = 1000 Hz
- Output data rate = 4000 Hz

AXES OF ACCELERATION SENSITIVITY

Figure 58 shows the axes of acceleration sensitivity. Note that the output voltage increases when accelerated along the sensitive axis.

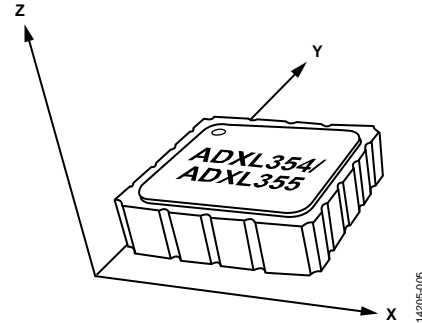

Figure 58. Axes of Acceleration Sensitivity

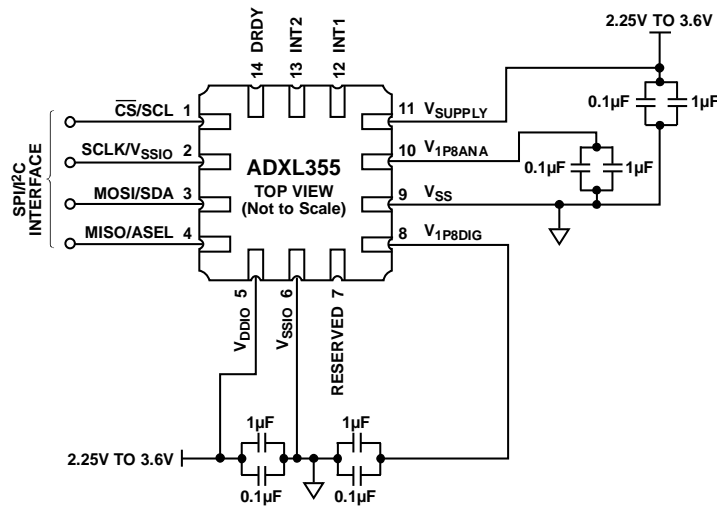

Figure 59. ADXL355 Application Circuit

POWER SEQUENCING

There are two methods for applying power to the device. Typically, internal LDO regulators generate the 1.8 V power for the analog and digital supplies, V_{IP8ANA} and V_{IP8DIG} , respectively. Optionally, connecting V_{SUPPLY} to V_{SS} and driving V_{IP8ANA} and V_{IP8DIG} with an external supply can supply V_{IP8ANA} and V_{IP8DIG} .

When using the internal LDO regulators, connect V_{SUPPLY} to a voltage source between 2.25 V to 3.6 V. In this case, V_{DDIO} and V_{SUPPLY} can be powered in parallel. V_{SUPPLY} must not exceed the V_{DDIO} voltage by greater than 0.5 V. If necessary, V_{DDIO} can be powered before V_{SUPPLY} .

When disabling the internal LDO regulators and using an external 1.8 V supply to power V_{IP8ANA} and V_{IP8DIG} , tie V_{SUPPLY} to ground, and set V_{IP8ANA} and V_{IP8DIG} to the same final voltage level. In the case of bypassing the LDOs, the recommended power sequence is to apply power to V_{DDIO} , followed by applying power to V_{IP8DIG} approximately 10 μ s later, and then applying power to V_{IP8ANA} approximately 10 μ s later. If necessary, V_{IP8DIG} and V_{DDIO} can be powered from the same 1.8 V supply, which can also be tied to V_{IP8ANA} with proper isolation. In this case, proper decoupling and low frequency isolation is important to maintain the noise performance of the sensor.

POWER SUPPLY DESCRIPTION

The [ADXL354/ADXL355](#) have four different power supply domains: V_{SUPPLY} , V_{IP8ANA} , V_{IP8DIG} , and V_{DDIO} . The internal analog and digital circuitry operates at 1.8 V nominal.

V_{SUPPLY}

V_{SUPPLY} is 2.25 V to 3.6 V, which is the input range to the two LDO regulators that generate the nominal 1.8 V outputs for V_{IP8ANA} and V_{IP8DIG} . Connect V_{SUPPLY} to V_{SS} to disable the LDO regulators, which allows driving V_{IP8ANA} and V_{IP8DIG} from an external source.

V_{IP8ANA}

All sensor and analog signal processing circuitry operates in this domain. Offset and sensitivity of the analog output [ADXL354](#) are ratiometric to this supply voltage. When using external ADCs, use V_{IP8ANA} as the reference voltage. The digital output [ADXL355](#) includes ADCs that are ratiometric to V_{IP8ANA} , thereby rendering offset and sensitivity insensitive to the value of V_{IP8ANA} . V_{IP8ANA} can be an input or an output as defined by the state of the V_{SUPPLY} voltage.

V_{IP8DIG}

V_{IP8DIG} is the supply voltage for the internal logic circuitry. A separate LDO regulator decouples the digital supply noise from the analog signal path. V_{IP8ANA} can be an input or an output as defined by the state of the V_{SUPPLY} voltage. If driven externally, V_{IP8DIG} must be the same voltage as the V_{IP8ANA} voltage.

V_{DDIO}

The V_{DDIO} value determines the logic high levels. On the analog output [ADXL354](#), V_{DDIO} sets the logic high level for the self test pins, ST1 and ST2, as well as the STBY pin. On the digital output [ADXL355](#), V_{DDIO} sets the logic high level for communications interface ports, as well as the interrupt and DRDY outputs.

The LDO regulators are operational when V_{SUPPLY} is between 2.25 V and 3.6 V. V_{IP8ANA} and V_{IP8DIG} are the regulator outputs in this mode. Alternatively, when tying V_{SUPPLY} to V_{SS} , V_{IP8ANA} and V_{IP8DIG} are supply voltage inputs with a 1.62 V to 1.98 V range.

OVERRANGE PROTECTION

The maximum nominal measurement range for the [ADXL354/ADXL355](#) is $\pm 8 g$. Do not subject the device to (or use the device in) applications or assembly processes that reasonably expect to exceed this level of acceleration, particularly for long durations or on an ongoing basis. In such applications, the [ADXL356/ADXL357](#) offer higher g ranges that may be better suited for such applications.

If an overrange event does occur, all sensor drive clocks turn off for 0.5 ms to avoid electrostatic capture of the proof mass when the accelerometer is subject to input acceleration beyond the full-scale range. In the $\pm 2 g/\pm 2.048 g$ range setting, the overrange protection activates for input signals beyond approximately $\pm 8 g/\pm 8.192 g$ ($\pm 25\%$), and for the $\pm 4 g/\pm 4.096 g$ and $\pm 8 g/\pm 8.192 g$ range settings, the threshold corresponds to about $\pm 16 g$ ($\pm 25\%$).

When overrange protection occurs, the X_{OUT} , Y_{OUT} , and Z_{OUT} pins on the [ADXL354](#) begin to drive to midscale. The [ADXL355](#) floats toward zero, and the first in, first out (FIFO) begins filling with this data.

SELF TEST

The [ADXL354](#) and [ADXL355](#) incorporate a self test feature that effectively tests their mechanical and electronic systems simultaneously. In [ADXL354](#), drive the ST1 pin to V_{DDIO} to invoke self test mode. Then, by driving the ST2 pin to V_{DDIO} , the [ADXL354](#) applies an electrostatic force to the mechanical sensor and induces a change in output in response to the force. The self test delta (or response) is the difference in output voltages between when ST2 is high and ST2 is low, both when ST1 is asserted. After the self test measurement is complete, bring both pins low to resume normal operation.

The self test operation is similar in the [ADXL355](#), except ST1 and ST2 can be accessed through the SELF_TEST register (Register 0x2E).

The self test feature rejects externally applied acceleration and only responds to the self test force, which allows an accurate measurement of the self test, even in the presence of external mechanical noise.

FILTER

The ADXL354/ADXL355 use an analog, low-pass, antialiasing filter to reduce out of band noise and to limit bandwidth. The ADXL355 provides further digital filtering options to maintain excellent noise performance at various ODRs.

The analog, low-pass antialiasing filter in the ADXL354/ADXL355 provides a fixed bandwidth of approximately 1.5 kHz, which is where the output response is attenuated by approximately 50%. The shape of the filter response in the frequency domain is that of a sinc3 filter.

The ADXL354 x-axis, y-axis, and z-axis analog outputs include an amplifier followed by a series 32 kΩ resistor and output to the X_{OUT}, the Y_{OUT}, and the Z_{OUT} pins, respectively.

The ADXL355 provides an internal 20-bit, Σ-Δ ADC to digitize the filtered analog signal. Additional digital filtering (beyond the analog, low-pass, antialiasing filter) consists of a low-pass digital decimation filter and a bypassable high-pass filter that supports output data rates between 4 kHz and 3.9 Hz. The decimation filter consists of two stages. The first stage is fixed decimation with a 4 kHz ODR with a low-pass filter cutoff (50% reduction in output response) at about 1 kHz. A variable second stage decimation filter is used for the 2 kHz output data rate and below (it is bypassed for 4 kHz ODR). Figure 60 shows the low-pass filter response with a 1 kHz corner (4 kHz ODR) for the ADXL355. Note that Figure 60 does not include the fixed frequency analog, low-pass, antialiasing filter with a fixed bandwidth of approximately 1.5 kHz.

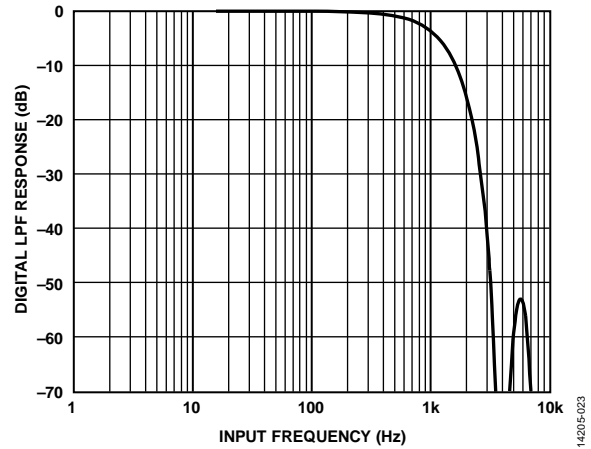

Figure 60. ADXL355 Digital Low-Pass Filter (LPF) Response for 4 kHz ODR

The ADXL355 pass band of the signal path relates to the combined filter responses, including the analog filter previously discussed, and the digital decimation filter/ODR setting. Table 9 shows the delay associated with the decimation filter for each setting and provides the attenuation at the ODR/4 corner.

Table 9. Digital Filter Group Delay and Profile

Programmed ODR (Hz)	Delay		Attenuation	
	ODR (Cycles)	Time (ms)	Decimator at ODR/4 (dB)	Full Path at ODR/4 (dB)
4000	2.52	0.63	-3.44	-3.63
4000/2 = 2000	2.00	1.00	-2.21	-2.26
4000/4 = 1000	1.78	1.78	-1.92	-1.93
4000/8 = 500	1.63	3.26	-1.83	-1.83
4000/16 = 250	1.57	6.27	-1.83	-1.83
4000/32 = 125	1.54	12.34	-1.83	-1.83
4000/64 = 62.5	1.51	24.18	-1.83	-1.83
4000/128 ~ 31	1.49	47.59	-1.83	-1.83
4000/256 ~ 16	1.50	96.25	-1.83	-1.83
4000/512 ~ 8	1.50	189.58	-1.83	-1.83
4000/1024 ~ 4	1.50	384.31	-1.83	-1.83

The **ADXL355** also includes an optional digital high-pass filter with a programmable corner frequency. By default, the high-pass filter is disabled. The high pass corner frequency, where the output is attenuated by 50%, is related to the ODR, and the HPF_CORNER setting in the filter register (Register 0x28, Bits[6:4]). Table 10 shows the HPF_CORNER response. Figure 61 and Figure 62 show the simulated high-pass filter response and delay for a 10 Hz cutoff.

The **ADXL355** also includes an interpolation filter after the decimation filters to produce oversampled/upconverted data that provides an external synchronization option. See the Data Synchronization section for more details. Table 11 shows the delay and attenuation relative to the programmed ODR.

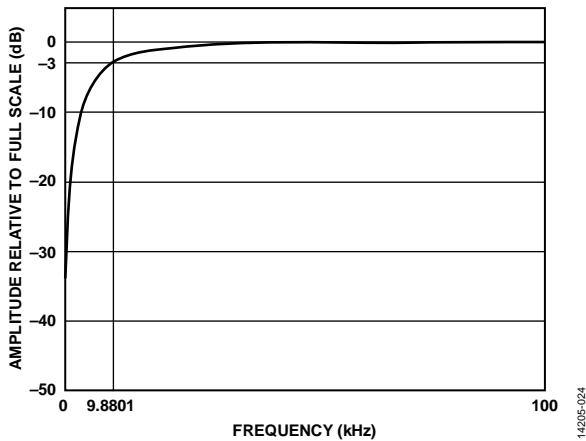

Figure 61. High-Pass Filter Pass-Band Response for a 4 kHz ODR and an HPF_CORNER Setting of 001 (Register 0x28, Bits[6:4])

Group delay is the digital filter delay from the input to the ADC until data is available at the interface (see the Filter section). This delay is the largest component of the total delay from sensor to serial interface.

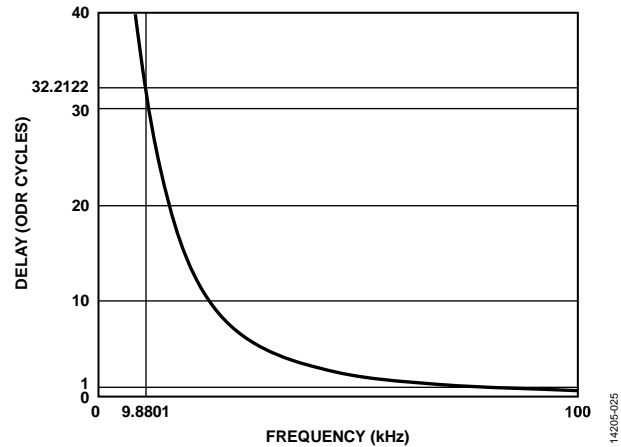

Figure 62. High-Pass Filter Delay Response for a 4 kHz ODR and an HPF_CORNER Setting of 001 (Register 0x28, Bits[6:4])

Table 10. Digital High-Pass Filter Response

HPF_CORNER Register Setting (Register 0x28, Bits[6:4])	HPF_CORNER Frequency, -3 dB Point Relative to ODR Setting	-3 dB at 4 kHz ODR (Hz)
000	Not applicable, no high-pass filter enabled	Off
001	$24.7 \times 10^{-4} \times \text{ODR}$	9.88
010	$6.2084 \times 10^{-4} \times \text{ODR}$	2.48
011	$1.5545 \times 10^{-4} \times \text{ODR}$	0.62
100	$0.3862 \times 10^{-4} \times \text{ODR}$	0.1545
101	$0.0954 \times 10^{-4} \times \text{ODR}$	0.03816
110	$0.0238 \times 10^{-4} \times \text{ODR}$	0.00952

Table 11. Combined Digital Interpolation Filter and Decimation Filter Response

Interpolator Data Rate Resolution Relative to $64 \times \text{ODR}$ (Hz)	Combined Interpolator/Decimator Delay (ODR Cycles)	Combined Interpolator/Decimator Delay (ms)	Combined Interpolator/Decimator Output Attenuation at ODR/4 (dB)
$64 \times 4000 = 256000$	3.51661	0.88	-6.18
$64 \times 2000 = 128000$	3.0126	1.51	-4.93
$64 \times 1000 = 64000$	2.752	2.75	-4.66
$64 \times 500 = 32000$	2.6346	5.27	-4.58
$64 \times 250 = 16000$	2.5773	10.31	-4.55
$64 \times 125 = 8000$	2.5473	20.38	-4.55
$64 \times 62.5 = 4000$	2.53257	40.52	-4.55
$64 \times 31.25 = 2000$	2.52452	80.78	-4.55
$64 \times 15.625 = 1000$	2.52045	161.31	-4.55
$64 \times 7.8125 = 500$	2.5194	322.48	-4.55
$64 \times 3.90625 = 250$	2.51714	644.39	-4.55

SERIAL COMMUNICATIONS

The 4-wire serial interface communicates in either the SPI or I²C protocol. It affectively autodetects the format being used, requiring no configuration control to select the format.

SPI PROTOCOL

Wire the [ADXL355](#) for SPI communication as shown in the connection diagram in Figure 63. The SPI protocol timing is shown in Figure 64 to Figure 67. The timing scheme follows the clock polarity (CPOL) = 0 and clock phase (CPHA) = 0. The SPI clock speed ranges from 100 kHz to 10 MHz.

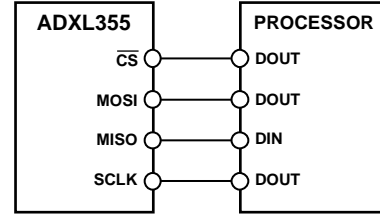

Figure 63. 4-Wire SPI Connection

14205-026

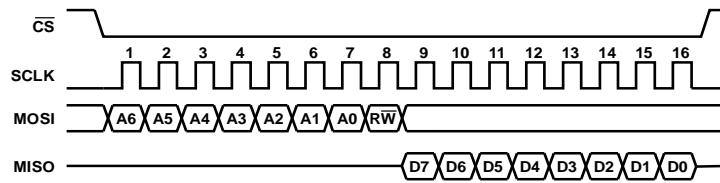

Figure 64. SPI Timing Diagram—Single-Byte Read

14205-027

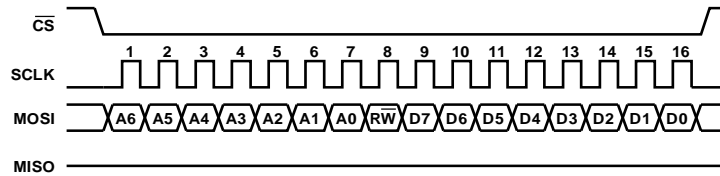

Figure 65. SPI Timing Diagram—Single-Byte Write

14205-028

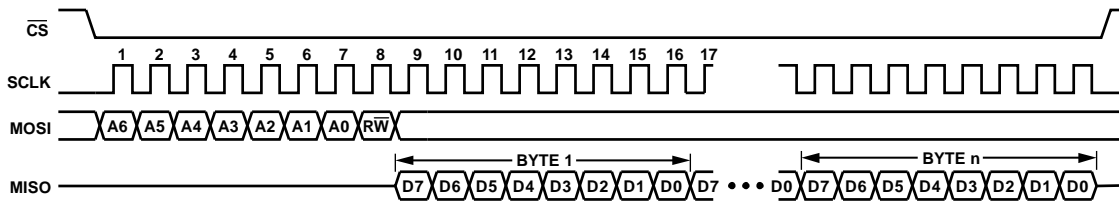

Figure 66. SPI Timing Diagram—Multibyte Read

14205-029

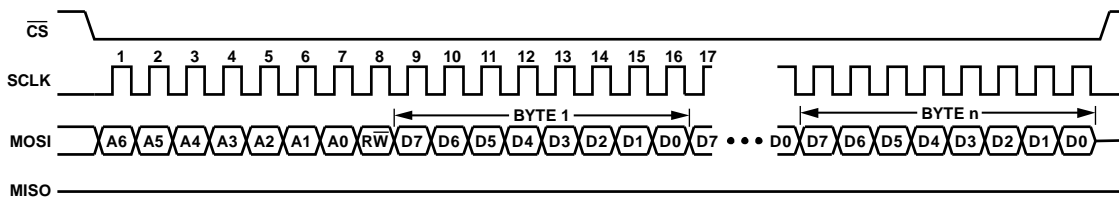

Figure 67. SPI Timing Diagram—Multibyte Write

14205-030

I²C PROTOCOL

Figure 68 to Figure 70 detail the I²C protocol timing. The I²C interface can be used on most buses operating in I²C standard mode (100 kHz), fast mode (400 kHz), fast mode plus (1 MHz), and high speed mode (3.4 MHz). The ADXL355 I²C device ID is as follows:

- ASEL (pin) = 0, device address = 0x1D
- ASEL (pin) = 1, device address = 0x53

READING ACCELERATION OR TEMPERATURE DATA FROM THE INTERFACE

Acceleration data is left justified and has a register address order of most significant data to least significant data, which allows the user to use multibyte transfers and to take only as much data as required—either 8 bits, 16 bits, or 20 bits plus the marker. Temperature data is 12 bits unsigned, right justified. The data in XDATA, YDATA, and ZDATA is always the most

recent available. It is not guaranteed that XDATA, YDATA, and ZDATA form a set corresponding to one sample point in time. The routine used to retrieve the data from the device controls this data set continuity. If data transfers are initiated when the DATA_RDY bit goes high and completes in a time approximately equal to 1/ODR, XDATA, YDATA, and ZDATA apply to the same data set.

For multibyte read or write transactions through either serial interface, the internal register address autoincrements. When the top of the register address range, 0x3FF, is reached the auto-increment stops and does not wrap back to Hex Address 0x00.

The address autoincrement function disables when the FIFO address is used, so that data can be read continuously from the FIFO as a multibyte transaction. In cases where the starting address of a multibyte transaction is less than the FIFO address, the address autoincrements until reaching the FIFO address, and then stops at the FIFO address.

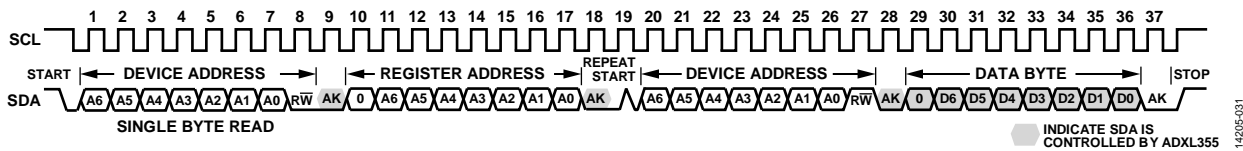

Figure 68. I²C Timing Diagram—Single-Byte Read



Figure 69. I²C Timing Diagram—Single-Byte Write

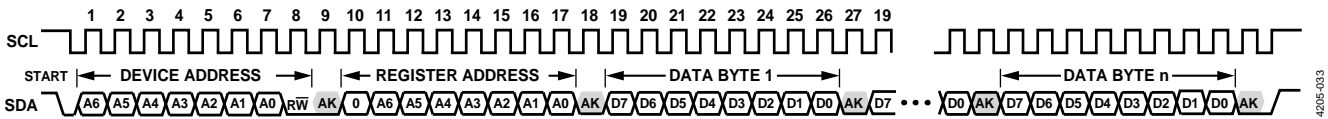

Figure 70. I²C Timing Diagram—Multibyte Write

FIFO

FIFO operates in a stream mode, that is, when the FIFO overruns new data overwrites the oldest data in the FIFO. A read from the FIFO address guarantees that the three bytes associated with the acceleration measurement on an axis all pertain to the same measurement. The FIFO never overruns, and data is always taken out in sets (multiples of three data points).

There are 96 21-bit locations in the FIFO. Each location contains 20 bits of data and a marker bit for the x-axis data. A single-byte read from the FIFO address pops one location from the FIFO. A multibyte read to the FIFO location pops the FIFO on the read of the first byte and every third byte read thereafter.

Figure 71 shows the organization of the data in the FIFO. The acceleration data is two's complement, 20-bit data. The FIFO control logic inserts the two LSB reads on the interface. Bit 1 indicates that an attempt was made to read an empty FIFO, and that the data is not valid acceleration data. Bit 0 is a marker bit to identify the x-axis, which allows a user to verify that the FIFO data was correctly read. An acceleration data point for a given axis occupies one FIFO location. The read pointer, RD_PTR, points to the oldest stored data that was not read already from the interface (see Figure 71). There are no physical x-acceleration, y-acceleration, or z-acceleration data registers. This data also comes directly from the most recent data set in the FIFO, which points to by the z pointer, Z_PTR, (see Figure 71).

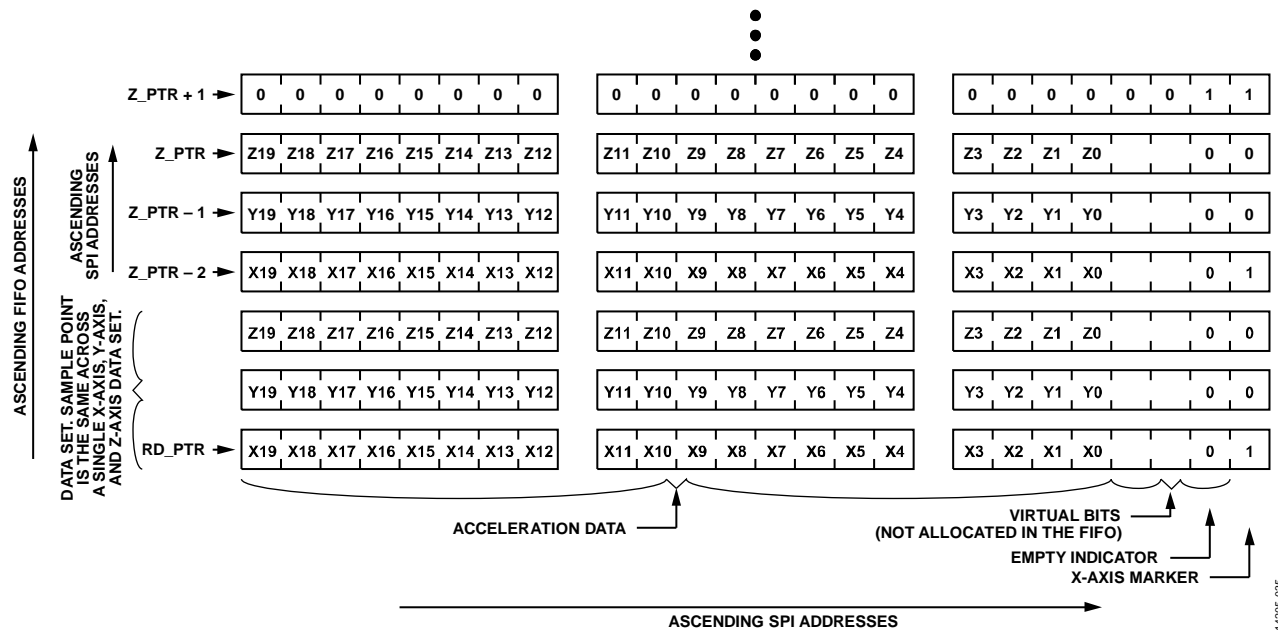

Figure 71. FIFO Data Organization

INTERRUPTS

The status register (Register 0x04) contains five individual bits, four of which can be mapped to either the INT1 pin, the INT2 pin, or both. The polarity of the interrupt, active high or active low, is also selectable via the INT_POL bit in the range (Register 0x2C) register. In general, the status register clears when read, but this is not the case if the condition that caused the interrupt persists after the read of the register. The definition of persist varies slightly in each case, but it is described in the following sections. The DRDY pin is similar to an interrupt pins (INTx) but clears very differently. This case is also described.

DATA_RDY

The DATA_RDY bit is set when new acceleration data is available to the interface. It clears on a read of the status register. It is not set again until acceleration data that is newer than the status register read is available.

Special logic on the clear of the DATA_RDY bit covers the corner case where new data arrives during the read of the status register. In this case, the data ready condition may be missed completely. This logic results in a delay of the clearing of DATA_RDY of up to four 512 kHz cycles.

DRDY PIN

DATA is not a status register bit; it instead behaves similar to an unmaskable interrupt. DRDY is set when new acceleration data is available to the interface. It clears on a read of the FIFO, on a read of XDATA, YDATA, or ZDATA, or by an autoclear function that occurs approximately halfway between output acceleration data sets.

DRDY is always active high. The INT_POL bit does not affect DRDY. In EXT_SYNC modes, the first few DRDY pulses after initial synchronization can be lost or corrupted. The length of this potential corruption is less than the group delay.

FIFO_FULL

The FIFO_FULL bit is set when the entries in the FIFO are equal to the setting of the FIFO_SAMPLES bits. It clears as follows:

- If the entries in the FIFO fall below the FIFO_SAMPLES, which is only the case if sufficient data is read from the FIFO.
- On a read of the status register, but only if the entries in the FIFO are less than the FIFO_SAMPLES bits.

FIFO_OVR

The FIFO_OVR bit is set when the FIFO is so far overrange that data is lost. The specified size of the FIFO is 96 locations. There is an additional three location buffer to compensate for delays in the synchronization of the clock domains. It is only when there is an attempt to write past this 99 location limit that FIFO_OVR is set.

A read of the status register clears FIFO_OVR. It is not set again until data is lost subsequent to this data register read.

ACTIVITY

The activity bit (Register 0x04, Bit 3) is set when the measured acceleration on any axis is above the ACT_THRESH bits for ACT_COUNT consecutive measurements. An over threshold condition can shift from one axis to another on successive measurements and is still counted toward the consecutive ACT_COUNT count.

A read of the status register clears the activity bit (Register 0x04, Bit 3), but it sets again at the end of the next measurement if the activity bit (Register 0x04, Bit 3) conditions are still satisfied.

NVM_BUSY

The NVM_BUSY bit indicates that the nonvolatile memory (NVM) controller is busy, and it cannot be accessed to read, write, or generate an interrupt.

A status register read that occurs after the NVM controller is no longer busy clears NVM_BUSY.

EXTERNAL SYNCHRONIZATION AND INTERPOLATION

There are three possible synchronization options for the ADXL355, shown in Figure 72 to Figure 74. For clarity, the clock frequencies and delays are drawn to scale. The labels in Figure 72 to Figure 74 are defined as follows:

- Internal ODR is the alignment of the decimated output data based on the internal clock.
- ADC clock shows the internal master clock rate
- DRDY is an output indicator signaling a sample is ready.

The three modes are include as follows:

- No external synchronization (internal clocks used)
- Synchronization with interpolation filter enabled
- Sync with an external sync and clock signals, no interpolation filter

EXT_SYNC = 00—No External Sync or Interpolation

For this case, an internal clock that serves as the synchronization master generates the data. No external signals are required, and this is used commonly when the external processor retrieves data from the device asynchronously and absolute synchronization to an external source is not required. Use Register 0x28 to program the ODR.

The device outputs a DRDY (active high) to signal that a new sample is available, and data is retrieved from the real-time registers or the FIFO. The group delay is based on the decimation setting as shown in Table 9.

EXT_SYNC = 10—External Sync with Interpolation

In this case, the internal clock generates data; however, an interpolation filter provides additional time resolution of 64 times the programmed ODR. Synchronization using interpolation filters and an external ODR clock is commonly used when the external processor can provide a synchronization signal (which is asynchronous to the internal clock) at the desired ODR. Synchronization with the interpolation filter enabled (EXT_SYNC = 10) allows the nonsynchronous external clock to output data most closely associated with the external clock rising edge. The interpolation filter provides a frequency resolution related to ODR (see Table 11).

The advantage of this mode is that data is available at a user defined sample rate and is asynchronous to the internal oscillator. The disadvantage of this mode is that the group delay is increased, and there is increased attenuation at the band edge. Additionally, because there is a limit to the time resolution, there is some distortion related to the mismatch of the external sync relative to the internal oscillator. This mismatch degrades spectral performance. The group delay is based on the decimation setting and interpolation setting (see Table 11). Table 13 shows the delay between the SYNC signal (input) to DRDY (output).

EXT_SYNC = 01—External Sync and External Clock

In this case, an external source provides an external clock at a frequency of $4 \times 64 \times \text{ODR}$. The external clock becomes the master clock source for the device. In addition, an external synchronization signal is needed to align the decimation filter output to a specific clock edge, which provides full external synchronization and is commonly used when a fixed external clock captures and processes data, and asynchronous clock(s) are not allowed. When using multiple sensors, synchronization with an external master clock is beneficial and requires time alignment.

When configured for EXT_SYNC = 01 with an ODR of 4 kHz, the user must supply an external clock at 1.024 MHz ($64 \times 4 \times 4 \text{ kHz}$) on the INT2 pin (Pin 13), and an external synchronization on DRDY pin (Pin 14), as shown in Table 12.

Special restrictions when using this mode include the following:

- An external clock (EXT_CLK) must be provided as well as an external sync.
- The frequency of EXT_CLK must be exactly $4 \times 64 \times \text{ODR}$.
- The width of sync must be a minimum of four EXT_CLK periods.
- The phase of sync must meet an approximate 25 ns setup time to the EXT_CLK rising edge.

When using the EXT_SYNC mode and without providing sync, the device runs on its own synchronization. Similarly, after synchronization, the device continues to run synchronized to the last sync pulse it received, which means that EXT_SYNC = 01 mode can be used with only a single synchronization pulse.

The interpolation filter provides a frequency resolution related to the ODR (see Table 11). In this case, the data provided corresponds to the external signal, which can be greater than the set ODR, but the output pass band remains the same it was prior to the interpolation filter.

Table 12. Multiplexing of INT2 and DRDY

Register or Bit Fields			Pins		Comments
EXT_CLK	EXT_SYNC[1:0]	INT_MAP[7:4]	INT2 (Pin 13)	DRDY (Pin 14)	
0	00	0000	Low	DRDY	Synchronization is to the internal clocks, and there is no external clock synchronization.
0	00	Not 0000	INT2	DRDY	
1	00	0000	EXT_CLK	DRDY	
1	00	Not 0000 ²	EXT_CLK	DRDY	
0	01	0000	DRDY	SYNC	These options reset the digital filters on every synchronization pulse and are not recommended.
0	01 ¹	Not 0000	INT2	SYNC	

Register or Bit Fields			Pins		Comments
EXT_CLK	EXT_SYNC[1:0]	INT_MAP[7:4]	INT2 (Pin 13)	DRDY (Pin 14)	
1	01 ¹	0000	EXT_CLK	SYNC	External synchronization, no interpolation filter, and DRDY (active high) signals that data is ready. Data represents a sample point group delay earlier in time.
1	01 ¹	Not 0000 ²	EXT_CLK	SYNC	
0	10	0000	DRDY	SYNC	External synchronization, interpolation filter, and DRDY (active high) signals that data is ready. Data sample group delay earlier in time.
0	10 ¹	Not 0000	INT2	SYNC	
1	10 ¹	0000	EXT_CLK	SYNC	
1	10 ¹	Not 0000	EXT_CLK	SYNC	

¹ No DRDY.

² No INT2, even though it is enabled.

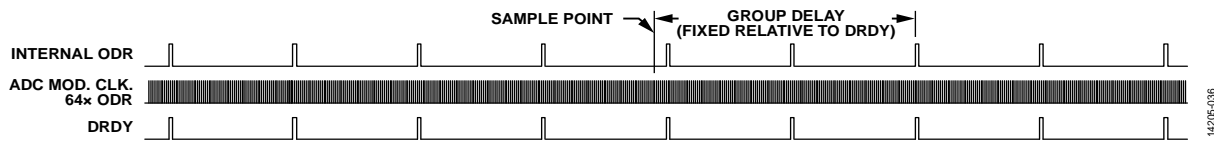

Figure 72. External Synchronization Option—EXT_SYNC = 00, Internal Sync

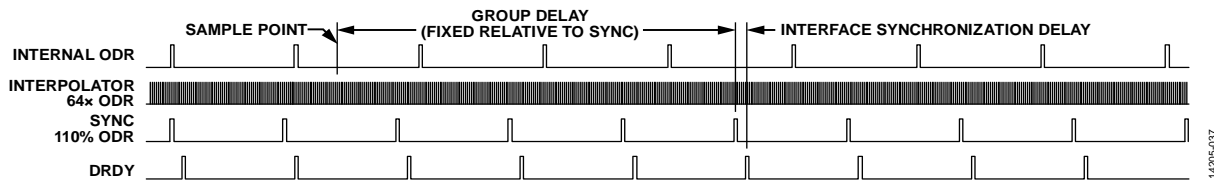

Figure 73. External Synchronization Option—EXT_SYNC = 10, External Sync, External Clock, Interpolation Filter

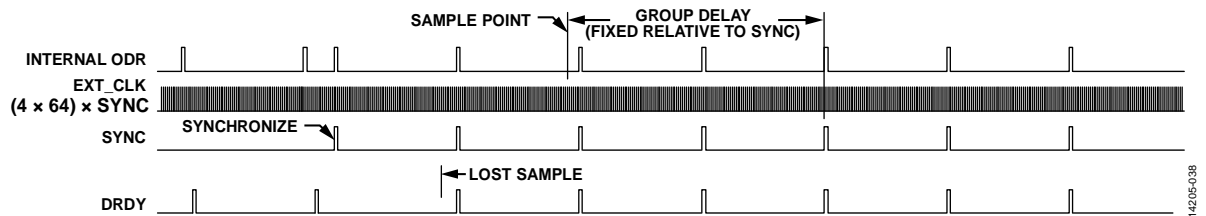

Figure 74. External Synchronization Option—EXT_SYNC = 01, External Sync, No Interpolation Filter

Table 13. EXT_SYNC = 10, DRDY Delay

ODR_LPF	Delay (OSC Cycles)
0x0	8
0x1	10
0x2	14
0x3	22
0x4	38
0x5	70
0x6	134
0x7	262
0x8	1031
0x9	2054
0x10	4102

ADXL355 REGISTER MAP

Note that while configuring the [ADXL355](#) in an application, all configuration registers must be programmed before enabling measurement mode in the `POWER_CTL` register. When the [ADXL355](#) is in measurement mode, only the following configurations can change: the `HPF_CORNER` bits in the filter register, the `INT_MAP` register, the `ST1` and `ST2` bits in the `SELF_TEST` register, and the reset register.

Table 14. ADXL355 Register Map

Hex. Addr.	Register Name	Bit 7	Bit 6	Bit 5	Bit 4	Bit 3	Bit 2	Bit 1	Bit 0	Reset	R/W	
0x00	DEVID_AD	DEVID_AD								0xAD	R	
0x01	DEVID_MST	DEVID_MST								0x1D	R	
0x02	PARTID	PARTID								0xED	R	
0x03	REVID	REVID								0x01	R	
0x04	Status	Reserved			NVM_BUSY	Activity	FIFO_OVR	FIFO_FULL	DATA_RDY	0x00	R	
0x05	FIFO_ENTRIES	Reserved	FIFO_ENTRIES								0x00	R
0x06	TEMP2	Reserved				Temperature, Bits[11:8]				0x00	R	
0x07	TEMP1	Temperature, Bits[7:0]								0x00	R	
0x08	XDATA3	XDATA, Bits[19:12]								0x00	R	
0x09	XDATA2	XDATA, Bits[11:4]								0x00	R	
0x0A	XDATA1	XDATA, Bits[3:0]				Reserved				0x00	R	
0x0B	YDATA3	YDATA, Bits[19:12]								0x00	R	
0x0C	YDATA2	YDATA, Bits[11:4]								0x00	R	
0x0D	YDATA1	YDATA, Bits[3:0]				Reserved				0x00	R	
0x0E	ZDATA3	ZDATA, Bits[19:12]								0x00	R	
0x0F	ZDATA2	ZDATA, Bits[11:4]								0x00	R	
0x10	ZDATA1	ZDATA, Bits[3:0]				Reserved				0x00	R	
0x11	FIFO_DATA	FIFO_DATA								0x00	R	
0x1E	OFFSET_X_H	OFFSET_X, Bits[15:8]								0x00	R/W	
0x1F	OFFSET_X_L	OFFSET_X, Bits[7:0]								0x00	R/W	
0x20	OFFSET_Y_H	OFFSET_Y, Bits[15:8]								0x00	R/W	
0x21	OFFSET_Y_L	OFFSET_Y, Bits[7:0]								0x00	R/W	
0x22	OFFSET_Z_H	OFFSET_Z, Bits[15:8]								0x00	R/W	
0x23	OFFSET_Z_L	OFFSET_Z, Bits[7:0]								0x00	R/W	
0x24	ACT_EN	Reserved					ACT_Z	ACT_Y	ACT_X	0x00	R/W	
0x25	ACT_THRESH_H	ACT_THRESH, Bits[15:8]								0x00	R/W	
0x26	ACT_THRESH_L	ACT_THRESH, Bits[7:0]								0x00	R/W	
0x27	ACT_COUNT	ACT_COUNT								0x01	R/W	
0x28	Filter	Reserved	HPF_CORNER				ODR_LPF				0x00	R/W
0x29	FIFO_SAMPLES	Reserved	FIFO_SAMPLES								0x60	R/W
0x2A	INT_MAP	ACT_EN2	OVR_EN2	FULL_EN2	RDY_EN2	ACT_EN1	OVR_EN1	FULL_EN1	RDY_EN1	0x00	R/W	
0x2B	Sync	Reserved					EXT_CLK	EXT_SYNC			0x00	R/W
0x2C	Range	I2C_HS	INT_POL	Reserved				Range			0x81	R/W
0x2D	POWER_CTL	Reserved					DRDY_OFF	TEMP_OFF	STANDBY	0x01	R/W	
0x2E	SELF_TEST	Reserved						ST2	ST1	0x00	R/W	
0x2F	Reset	Reset								0x00	W	

REGISTER DEFINITIONS

This section describes the functions of the [ADXL355](#) registers. The [ADXL355](#) powers up with the default register values, as shown in the Reset column of Table 14.

ANALOG DEVICES ID REGISTER

This register contains the Analog Devices ID, 0xAD.

Address: 0x00, Reset: 0xAD, Name: DEVID_AD

Table 15. Bit Descriptions for DEVID_AD

Bits	Bit Name	Settings	Description	Reset	Access
[7:0]	DEVID_AD		Analog Devices ID	0xAD	R

ANALOG DEVICES MEMS ID REGISTER

This register contains the Analog Devices MEMS ID, 0x1D.

Address: 0x01, Reset: 0x1D, Name: DEVID_MST

Table 16. Bit Descriptions for DEVID_MST

Bits	Bit Name	Settings	Description	Reset	Access
[7:0]	DEVID_MST		Analog Devices MEMS ID	0x1D	R

DEVICE ID REGISTER

This register contains the device ID, 0xED (355 octal).

Address: 0x02, Reset: 0xED, Name: PARTID

Table 17. Bit Descriptions for PARTID

Bits	Bit Name	Settings	Description	Reset	Access
[7:0]	PARTID		Device ID (355 octal)	0xED	R

PRODUCT REVISION ID REGISTER

This register contains the product revision ID, beginning with 0x00 and incrementing for each subsequent revision.

Address: 0x03, Reset: 0x00, Name: REVID

Table 18. Bit Descriptions for REVID

Bits	Bit Name	Settings	Description	Reset	Access
[7:0]	REVID		Mask revision	0x01	R

STATUS REGISTER

This register includes bits that describe the various conditions of the [ADXL355](#).

Address: 0x04, Reset: 0x00, Name: STATUS

Table 19. Bit Descriptions for STATUS

Bits	Bit Name	Settings	Description	Reset	Access
[7:5]	Reserved		Reserved.	0x0	R
4	NVM_BUSY		NVM controller is busy with either refresh, programming, or built-in, self test (BIST).	0x0	R
3	Activity		Activity, as defined in the THRESH_ACT and COUNT_ACT registers, is detected.	0x0	R
2	FIFO_OVR		FIFO has overrun, and the oldest data is lost.	0x0	R
1	FIFO_FULL		FIFO watermark is reached.	0x0	R
0	DATA_RDY		A complete x-axis, y-axis, and z-axis measurement was made and results can be read.	0x0	R

FIFO ENTRIES REGISTER

This register indicates the number of valid data samples present in the FIFO buffer. This number ranges from 0 to 96.

Address: 0x05, Reset: 0x00, Name: FIFO_ENTRIES

Table 20. Bit Descriptions for FIFO_ENTRIES

Bits	Bit Name	Settings	Description	Reset	Access
7	Reserved		Reserved	0x0	R
[6:0]	FIFO_ENTRIES		Number of data samples stored in the FIFO	0x0	R

TEMPERATURE DATA REGISTERS

These two registers contain the uncalibrated temperature data. The nominal intercept is 1852 LSB at 25°C and the nominal slope is -9.05 LSB/°C. TEMP2 contains the four most significant bits, and TEMP1 contains the eight least significant bits of the 12-bit value.

Address: 0x06, Reset: 0x00, Name: TEMP2

Table 21. Bit Descriptions for TEMP2

Bits	Bit Name	Settings	Description	Reset	Access
[7:4]	Reserved		Reserved.		
[3:0]	Temperature, Bits[11:8]		Uncalibrated temperature data	0x0	R

Address: 0x07, Reset: 0x00, Name: TEMP1

Table 22. Bit Descriptions for TEMP1

Bits	Bit Name	Settings	Description	Reset	Access
[7:0]	Temperature, Bits[7:0]		Uncalibrated temperature data	0x0	R

X-AXIS DATA REGISTERS

These three registers contain the x-axis acceleration data. Data is left justified and formatted as twos complement.

Address: 0x08, Reset: 0x00, Name: XDATA3

Table 23. Bit Descriptions for XDATA3

Bits	Bit Name	Settings	Description	Reset	Access
[7:0]	XDATA, Bits[19:12]		X-axis data	0x0	R

Address: 0x09, Reset: 0x00, Name: XDATA2

Table 24. Bit Descriptions for XDATA2

Bits	Bit Name	Settings	Description	Reset	Access
[7:0]	XDATA, Bits[11:4]		X-axis data	0x0	R

Address: 0x0A, Reset: 0x00, Name: XDATA1

Table 25. Bit Descriptions for XDATA1

Bits	Bit Name	Settings	Description	Reset	Access
[7:4]	XDATA, Bits[3:0]		X-axis data	0x0	R
[3:0]	Reserved		Reserved	0x0	R

Y-AXIS DATA REGISTERS

These three registers contain the y-axis acceleration data. Data is left justified and formatted as twos complement.

Address: 0x0B, Reset: 0x00, Name: YDATA3

Table 26. Bit Descriptions for YDATA3

Bits	Bit Name	Settings	Description	Reset	Access
[7:0]	YDATA, Bits[19:12]		Y-axis data	0x0	R

Address: 0x0C, Reset: 0x00, Name: YDATA2

Table 27. Bit Descriptions for YDATA2

Bits	Bit Name	Settings	Description	Reset	Access
[7:0]	YDATA, Bits[11:4]		Y-axis data	0x0	R

Address: 0x0D, Reset: 0x00, Name: YDATA1

Table 28. Bit Descriptions for YDATA1

Bits	Bit Name	Settings	Description	Reset	Access
[7:4]	YDATA, Bits[3:0]		Y-axis data	0x0	R
[3:0]	Reserved		Reserved	0x0	R

Z-AXIS DATA REGISTERS

These three registers contain the z-axis acceleration data. Data is left justified and formatted as twos complement.

Address: 0x0E, Reset: 0x00, Name: ZDATA3

Table 29. Bit Descriptions for ZDATA3

Bits	Bit Name	Settings	Description	Reset	Access
[7:0]	ZDATA, Bits[19:12]		Z-axis data	0x0	R

Address: 0x0F, Reset: 0x00, Name: ZDATA2

Table 30. Bit Descriptions for ZDATA2

Bits	Bit Name	Settings	Description	Reset	Access
[7:0]	ZDATA, Bits[11:4]		Z-axis data	0x0	R

Address: 0x10, Reset: 0x00, Name: ZDATA1

Table 31. Bit Descriptions for ZDATA1

Bits	Bit Name	Settings	Description	Reset	Access
[7:4]	ZDATA, Bits[3:0]		Z-axis data	0x0	R
[3:0]	Reserved		Reserved	0x0	R

FIFO ACCESS REGISTER**Address: 0x11, Reset: 0x00, Name: FIFO_DATA**

Read this register to access data stored in the FIFO.

Table 32. Bit Descriptions for FIFO_DATA

Bits	Bit Name	Settings	Description	Reset	Access
[7:0]	FIFO_DATA		FIFO data is formatted to 24 bits, 3 bytes, most significant byte first. A read to this address pops an effective three equal byte words of axis data from the FIFO. Two subsequent reads or a multibyte read completes the transaction of this data onto the interface. Continued reading or a sustained multibyte read of this field continues to pop the FIFO every third byte. Multibyte reads to this address do not increment the address pointer. If this address is read due to an autoincrement from the previous address, it does not pop the FIFO. Instead, it returns zeros and increments on to the next address.	0x0	R

X-AXIS OFFSET TRIM REGISTERS**Address: 0x1E, Reset: 0x00, Name: OFFSET_X_H****Table 33. Bit Descriptions for OFFSET_X_H**

Bits	Bit Name	Settings	Description	Reset	Access
[7:0]	OFFSET_X, Bits[15:8]		Offset added to x-axis data after all other signal processing. Data is in twos complement format. The significance of OFFSET_X[15:0] matches the significance of XDATA[19:4].	0x0	R/W

Address: 0x1F, Reset: 0x00, Name: OFFSET_X_L**Table 34. Bit Descriptions for OFFSET_X_L**

Bits	Bit Name	Settings	Description	Reset	Access
[7:0]	OFFSET_X, Bits[7:0]		Offset added to x-axis data after all other signal processing. Data is in twos complement format. The significance of OFFSET_X[15:0] matches the significance of XDATA[19:4].	0x0	R/W

Y-AXIS OFFSET TRIM REGISTERS**Address: 0x20, Reset: 0x00, Name: OFFSET_Y_H****Table 35. Bit Descriptions for OFFSET_Y_H**

Bits	Bit Name	Settings	Description	Reset	Access
[7:0]	OFFSET_Y, Bits[15:8]		Offset added to y-axis data after all other signal processing. Data is in twos complement format. The significance of OFFSET_Y[15:0] matches the significance of YDATA[19:4].	0x0	R/W

Address: 0x21, Reset: 0x00, Name: OFFSET_Y_L**Table 36. Bit Descriptions for OFFSET_Y_L**

Bits	Bit Name	Settings	Description	Reset	Access
[7:0]	OFFSET_Y, Bits[7:0]		Offset added to y-axis data after all other signal processing. Data is in twos complement format. The significance of OFFSET_Y[15:0] matches the significance of YDATA[19:4].	0x0	R/W

Z-AXIS OFFSET TRIM REGISTERS**Address: 0x22, Reset: 0x00, Name: OFFSET_Z_H**

Table 37. Bit Descriptions for OFFSET_Z_H

Bits	Bit Name	Settings	Description	Reset	Access
[7:0]	OFFSET_Z, Bits[15:8]		Offset added to z-axis data after all other signal processing. Data is in twos complement format. The significance of OFFSET_Z[15:0] matches the significance of ZDATA[19:4].	0x0	R/W

Address: 0x23, Reset: 0x00, Name: OFFSET_Z_L

Table 38. Bit Descriptions for OFFSET_Z_L

Bits	Bit Name	Settings	Description	Reset	Access
[7:0]	OFFSET_Z, Bits[7:0]		Offset added to z-axis data after all other signal processing. Data is in twos complement format. The significance of OFFSET_Z[15:0] matches the significance of ZDATA[19:4].	0x0	R/W

ACTIVITY ENABLE REGISTER**Address: 0x24, Reset: 0x00, Name: ACT_EN**

Table 39. Bit Descriptions for ACT_EN

Bits	Bit Name	Settings	Description	Reset	Access
[7:3]	Reserved		Reserved.	0x0	R
2	ACT_Z		Z-axis data is a component of the activity detection algorithm.	0x0	R/W
1	ACT_Y		Y-axis data is a component of the activity detection algorithm.	0x0	R/W
0	ACT_X		X-axis data is a component of the activity detection algorithm.	0x0	R/W

ACTIVITY THRESHOLD REGISTERS**Address: 0x25, Reset: 0x00, Name: ACT_THRESH_H**

Table 40. Bit Descriptions for ACT_THRESH_H

Bits	Bit Name	Settings	Description	Reset	Access
[7:0]	ACT_THRESH[15:8]		Threshold for activity detection. Acceleration magnitude must be above ACT_THRESH to trigger the activity counter. ACT_THRESH is an unsigned magnitude. The significance of ACT_TRESH[15:0] matches the significance of XDATA, YDATA, and ZDATA[18:3].	0x0	R/W

Address: 0x26, Reset: 0x00, Name: ACT_THRESH_L

Table 41. Bit Descriptions for THRESH_ACT_X_L

Bits	Bit Name	Settings	Description	Reset	Access
[7:0]	ACT_THRESH[7:0]		Threshold for activity detection. Acceleration magnitude must be above ACT_THRESH to trigger the activity counter. ACT_THRESH is an unsigned magnitude. The significance of ACT_TRESH[15:0] matches the significance of XDATA, YDATA, and ZDATA[18:3].	0x0	R/W

ACTIVITY COUNT REGISTER**Address: 0x27, Reset: 0x01, Name: ACT_COUNT**

Table 42. Bit Descriptions for ACT_COUNT

Bits	Bit Name	Settings	Description	Reset	Access
[7:0]	ACT_COUNT		Number of consecutive events above threshold required to detect activity	0x1	R/W

FILTER SETTINGS REGISTER**Address: 0x28, Reset: 0x00, Name: Filter**

Use this register to specify parameters for the internal high-pass and low-pass filters.

Table 43. Bit Descriptions for Filter

Bits	Bit Name	Settings	Description	Reset	Access
7	Reserved		Reserved	0x0	R
[6:4]	HPF_CORNER	000 001 010 011 100 101 110	-3 dB filter corner for the first-order, high-pass filter relative to the ODR Not applicable, no high-pass filter enabled $247 \times 10^{-3} \times \text{ODR}$ $62.084 \times 10^{-3} \times \text{ODR}$ $15.545 \times 10^{-3} \times \text{ODR}$ $3.862 \times 10^{-3} \times \text{ODR}$ $0.954 \times 10^{-3} \times \text{ODR}$ $0.238 \times 10^{-3} \times \text{ODR}$	0x0	R/W
[3:0]	ODR_LPF	0000 0001 0010 0011 0100 0101 0110 0111 1000 1001 1010	ODR and low-pass filter corner 4000 Hz and 1000 Hz 2000 Hz and 500 Hz 1000 Hz and 250 Hz 500 Hz and 125 Hz 250 Hz and 62.5 Hz 125 Hz and 31.25 Hz 62.5 Hz and 15.625 Hz 31.25 Hz and 7.813 Hz 15.625 Hz and 3.906 Hz 7.813 Hz and 1.953 Hz 3.906 Hz and 0.977 Hz	0x0	R/W

FIFO SAMPLES REGISTER**Address: 0x29, Reset: 0x60, Name: FIFO_SAMPLES**

Use the FIFO_SAMPLES value to specify the number of samples to store in the FIFO. The default value of this register is 0x60 to avoid triggering the FIFO watermark interrupt.

Table 44. Bit Descriptions for FIFO_SAMPLES

Bits	Bit Name	Settings	Description	Reset	Access
7	Reserved		Reserved.	0x0	R
[6:0]	FIFO_SAMPLES		Watermark number of samples stored in the FIFO that triggers a FIFO_FULL condition. Values range from 1 to 96.	0x60	R/W

INTERRUPT PIN (INTx) FUNCTION MAP REGISTER**Address: 0x2A, Reset: 0x00, Name: INT_MAP**

The INT_MAP register configures the interrupt pins. Bits[7:0] select which function(s) generate an interrupt on the INT1 and INT2 pins. Multiple events can be configured. If the corresponding bit is set to 1, the function generates an interrupt on the interrupt pins.

Table 45. Bit Descriptions for INT_MAP

Bits	Bit Name	Settings	Description	Reset	Access
7	ACT_EN2		Activity interrupt enable on INT2	0x0	R/W
6	OVR_EN2		FIFO_OVR interrupt enable on INT2	0x0	R/W
5	FULL_EN2		FIFO_FULL interrupt enable on INT2	0x0	R/W
4	RDY_EN2		DATA_RDY interrupt enable on INT2	0x0	R/W
3	ACT_EN1		Activity interrupt enable on INT1	0x0	R/W
2	OVR_EN1		FIFO_OVR interrupt enable on INT1	0x0	R/W
1	FULL_EN1		FIFO_FULL interrupt enable on INT1	0x0	R/W
0	RDY_EN1		DATA_RDY interrupt enable on INT1	0x0	R/W

DATA SYNCHRONIZATION**Address: 0x2B, Reset: 0x00, Name: Sync**

Use this register to control the external timing triggers.

Table 46. Bit Descriptions for Sync

Bits	Bit Name	Settings	Description	Reset	Access
[7:3]	Reserved		Reserved.	0x0	R
2	EXT_CLK		Enable external clock.	0x0	R/W
[1:0]	EXT_SYNC		Enable external sync control.	0x0	R/W
		00	Internal sync.		
		01	External sync, no interpolation filter. After synchronization, and for EXT_SYNC within specification, DATA_RDY occurs on EXT_SYNC.		
		10	External sync, interpolation filter, next available data indicated by DATA_RDY 14 to 8204 oscillator cycles later (longer delay for higher ODR_LPF setting), data represents a sample point group delay earlier in time.		
		11	Reserved.		

I²C SPEED, INTERRUPT POLARITY, AND RANGE REGISTER**Address: 0x2C, Reset: 0x81, Name: Range****Table 47. Bit Descriptions for Range**

Bits	Bit Name	Settings	Description	Reset	Access
7	I2C_HS		I ² C speed. 1 = high speed mode. 0 = fast mode.	0x1	R/W
6	INT_POL		Interrupt polarity. 0 INT1 and INT2 are active low. 1 INT1 and INT2 are active high.	0x0	R/W
[5:2]	Reserved		Reserved.	0x0	R
[1:0]	Range		Range. 01 ±2 g. 10 ±4 g. 11 ±8 g.	0x1	R/W

POWER CONTROL REGISTER**Address: 0x2D, Reset: 0x01, Name: POWER_CTL****Table 48. Bit Descriptions for POWER_CTL**

Bits	Bit Name	Settings	Description	Reset	Access
[7:3]	Reserved		Reserved.	0x0	R
2	DRDY_OFF		Set to 1 to force the DRDY output to 0 in modes where it is normally signal data ready.	0x0	R/W
1	TEMP_OFF		Set to 1 to disable temperature processing. Temperature processing is also disabled when STANDBY = 1.	0x0	R/W
0	STANDBY		Standby or measurement mode.	0x1	R/W
		1	Standby mode. In standby mode, the device is in a low power state, and the temperature and acceleration datapaths are not operating. In addition, digital functions, including FIFO pointers, reset. Changes to the configuration setting of the device must be made when STANDBY = 1. An exception is a high-pass filter that can be changed when the device is operating.		
		0	Measurement mode.		

SELF TEST REGISTER**Address: 0x2E, Reset: 0x00, Name: SELF_TEST**

Refer to the Self Test section for more information on the operation of the self test feature.

Table 49. Bit Descriptions for SELF_TEST

Bits	Bit Name	Settings	Description	Reset	Access
[7:2]	Reserved		Reserved.	0x0	R
1	ST2		Set to 1 to enable self test force	0x0	R/W
0	ST1		Set to 1 to enable self test mode	0x0	R/W

RESET REGISTER**Address: 0x2F, Reset: 0x00, Name: Reset****Table 50. Bit Descriptions for Reset**

Bits	Bit Name	Settings	Description	Reset	Access
[7:0]	Reset		Write Code 0x52 to resets the device, similar to a power-on reset (POR)	0x0	W

RECOMMENDED SOLDERING PROFILE

Figure 75 and Table 51 provide details about the recommended soldering profile.

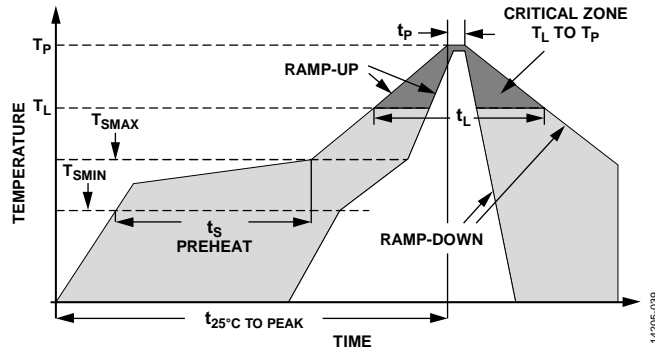

Figure 75. Recommended Soldering Profile

Table 51. Recommended Soldering Profile

Profile Feature	Condition	
	Sn63/Pb37	Pb-Free
Average Ramp Rate from Liquid Temperature (T_L) to Peak Temperature (T_P)	3°C/sec maximum	3°C/sec maximum
Preheat		
Minimum Temperature (T_{SMIN})	100°C	150°C
Maximum Temperature (T_{SMAX})	150°C	200°C
Time from T_{SMIN} to T_{SMAX} (t_s)	60 sec to 120 sec	60 sec to 180 sec
T_{SMAX} to T_L Ramp-Up Rate	3°C/sec maximum	3°C/sec maximum
Liquid Temperature (T_L)	183°C	217°C
Time Maintained Above T_L (t_L)	60 sec to 150 sec	60 sec to 150 sec
Peak Temperature (T_P)	240°C + 0°C/-5°C	260°C + 0°C/-5°C
Time of Actual $T_P - 5°C$ (t_p)	10 sec to 30 sec	20 sec to 40 sec
Ramp-Down Rate	6°C/sec maximum	6°C/sec maximum
Time from 25°C to Peak Temperature ($t_{25°C TO PEAK}$)	6 minutes maximum	8 minutes maximum

PCB FOOTPRINT PATTERN

Figure 76 shows the PCB footprint pattern and dimensions in millimeters.

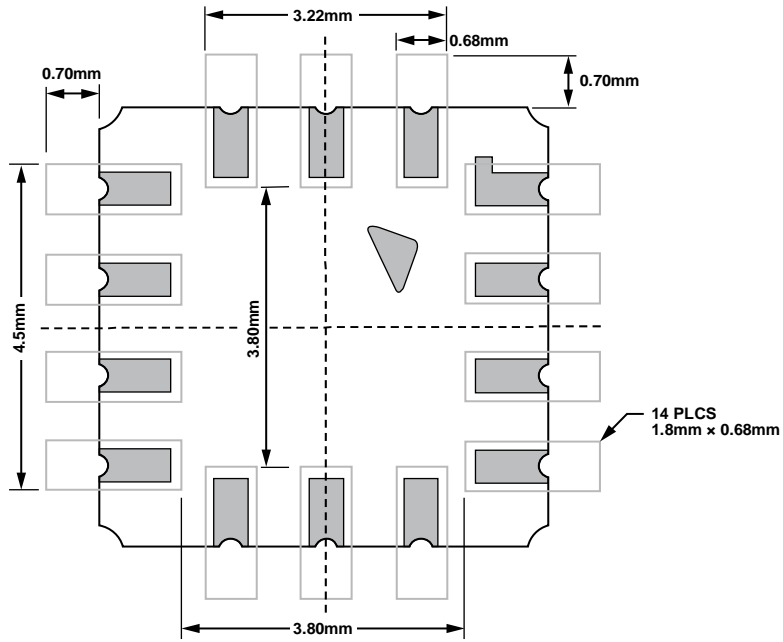

Figure 76. PCB Footprint Pattern and Dimensions in Millimeters

PACKAGING AND ORDERING INFORMATION
OUTLINE DIMENSIONS

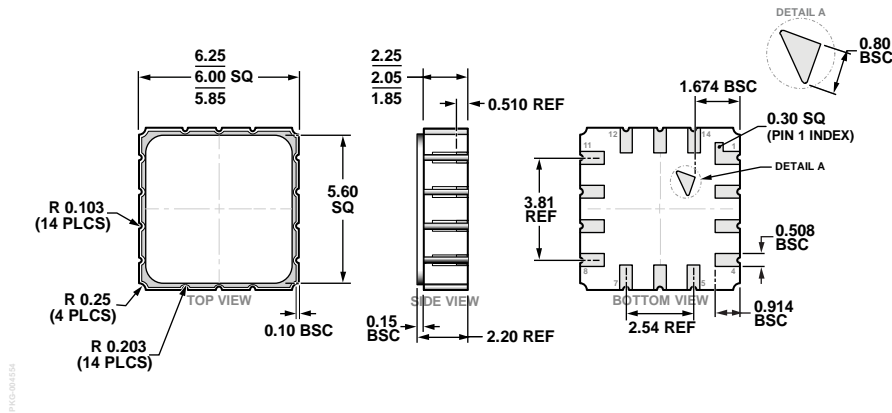

Figure 77. 14-Terminal Ceramic Leadless Chip Carrier [LCC] (E-14-1)
 Dimensions shown in millimeters

BRANDING INFORMATION

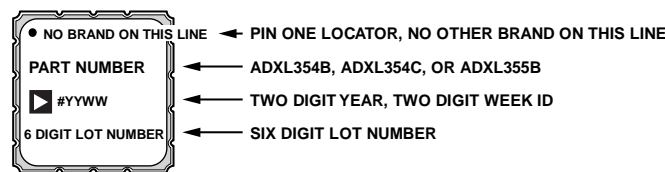

Figure 78. Branding Information

ORDERING GUIDE

Model ¹	Output Mode	Measurement Range (g)	Specified Voltage (V)	Temperature Range	Package Description	Package Option
ADXL354BEZ	Analog	±2, ±4	3.3	-40°C to +125°C	14-Terminal LCC	E-14-1
ADXL354BEZ-RL	Analog	±2, ±4	3.3	-40°C to +125°C	14-Terminal LCC	E-14-1
ADXL354BEZ-RL7	Analog	±2, ±4	3.3	-40°C to +125°C	14-Terminal LCC	E-14-1
ADXL354CEZ	Analog	±2, ±8	3.3	-40°C to +125°C	14-Terminal LCC	E-14-1
ADXL354CEZ-RL	Analog	±2, ±8	3.3	-40°C to +125°C	14-Terminal LCC	E-14-1
ADXL354CEZ-RL7	Analog	±2, ±8	3.3	-40°C to +125°C	14-Terminal LCC	E-14-1
ADXL355BEZ	Digital	±2.048, ±4.096, ±8.192	3.3	-40°C to +125°C	14-Terminal LCC	E-14-1
ADXL355BEZ-RL	Digital	±2.048, ±4.096, ±8.192	3.3	-40°C to +125°C	14-Terminal LCC	E-14-1
ADXL355BEZ-RL7	Digital	±2.048, ±4.096, ±8.192	3.3	-40°C to +125°C	14-Terminal LCC	E-14-1
EVAL-ADXL354BZ					Evaluation Board for ADXL354BEZ	
EVAL-ADXL354CZ					Evaluation Board for ADXL354CEZ	
EVAL-ADXL355Z					Evaluation Board for ADXL355BEZ	

¹ Z = RoHS-Compliant Part.

X-ON Electronics

Largest Supplier of Electrical and Electronic Components

Click to view similar products for [Accelerometers](#) category:

Click to view products by [Analog Devices](#) manufacturer:

Other Similar products are found below :

[SX8452QR1](#) [LIS3L02AL](#) [SHUTTLE BOARD BMA222E](#) [832-0050](#) [AD22372Z-RL7](#) [ADXL313WACPZ-RL](#) [MMA1200KEG](#) [1-1001220-0](#)
[MMA6331LT](#) [FXLN8362QR1](#) [LIS331HHTR](#) [MMA8452QR1](#) [MMA6331LR1](#) [MMA1220KEG](#) [SCA830-D05-1](#) [MXR9150MZ](#)
[D3965MMA7660FC](#) [BMA423](#) [BMA456](#) [MMA8653FCR1](#) [805M1-0200](#) [ADXL1002BCPZ](#) [834M1-2000](#) [3038-0050](#) [AD22301](#) [805-0500](#)
[ADXL189BWBRDZUP-RL](#) [3038-0100](#) [ADXL356CEZ](#) [4030-002-120](#) [805M1-0200-01](#) [MXP7205VW](#) [ADXL1001BCPZ](#) [ADXL354BEZ](#)
[805-0500-01](#) [ADXL357BEZ](#) [3038-0500](#) [MXA2500EL](#) [BU-23842-000](#) [KX126-1063](#) [810M1-0100X](#) [805-0050](#) [ADXL356BEZ](#) [832M1-0025](#)
[832M1-0500](#) [8101-0040X-120](#) [810M1-0025X](#) [805M1-0020](#) [ADXL700WBRWZ-RL](#) [834M1-6000](#)