

Pegasus

Contact blocks

Spring loaded Terminals



AUTOMATION TECHNOLOGIES

SPRING LOADED TERMINALS

		CONTACT BLOCKS			
	DESIGNATION	FUNCTIONS	CODE	DIMENSIONS	
		 0 1,5 6 mm	PCW01		
		 0 3,5 6 mm			

LAMPHOLDER BA9s

	DESIGNATION	POWER SUPPLY	CODE	DIMENSIONS
		BA9s lamp socket 250V 2,4 w max bulb not included	PCWAD	

LAMPHOLDER WITH BUILT-IN LED

	DESIGNATION	POWER SUPPLY	CODE	DIMENSIONS
		AC/DC 12V	PCW5L12	
		AC/DC 24V	PCW5L24	
		AC/DC 48V	PCW5L48	
		AC/DC 110V	PCW5L110	
		AC 220V	PCW5L220	

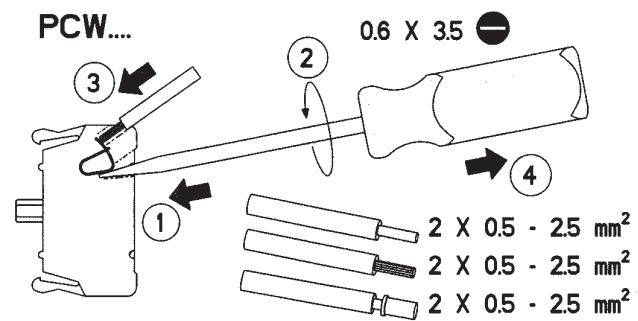
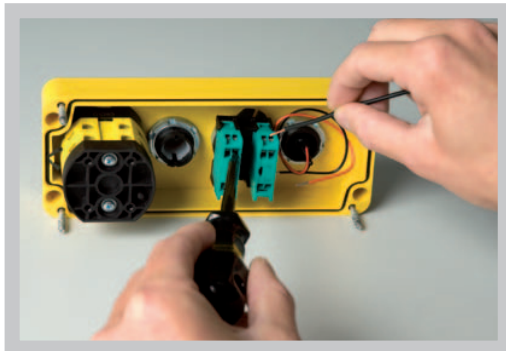





Pegasus

Contact blocks

Welding terminals

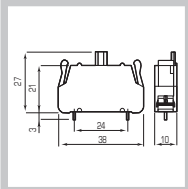
CONTACT BLOCKS

CONTACT BLOCKS				
DESIGNATION	FUNCTIONS	CODE	DIMENSIONS	
 <p>NC 1 — 2</p>	<p>0 1,5 6 mm</p> 	PSC01		
<p>NO 3 — 4</p>	<p>0 3,5 6 mm</p> 	PSC10		

LAMPHOLDER BA9s

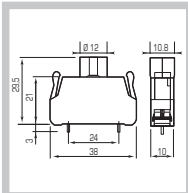
DESIGNATION	POWER SUPPLY	CODE	DIMENSIONS
 <p>X1 — X2</p>	<p>BA9s lamp socket 250V 2,4 w max bulb not included</p>	PSCAD	

LAMPHOLDER WITH BUILT-IN LED

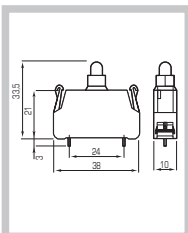
DESIGNATION	POWER SUPPLY	CODE	DIMENSIONS
 <p>X1 — X2</p>	AC/DC 12V	PSC5L12	
	AC/DC 24V	PSC5L24	
	AC/DC 48V	PSC5L48	
	AC/DC 110V	PSC5L110	
	AC 220V	PSC5L220	

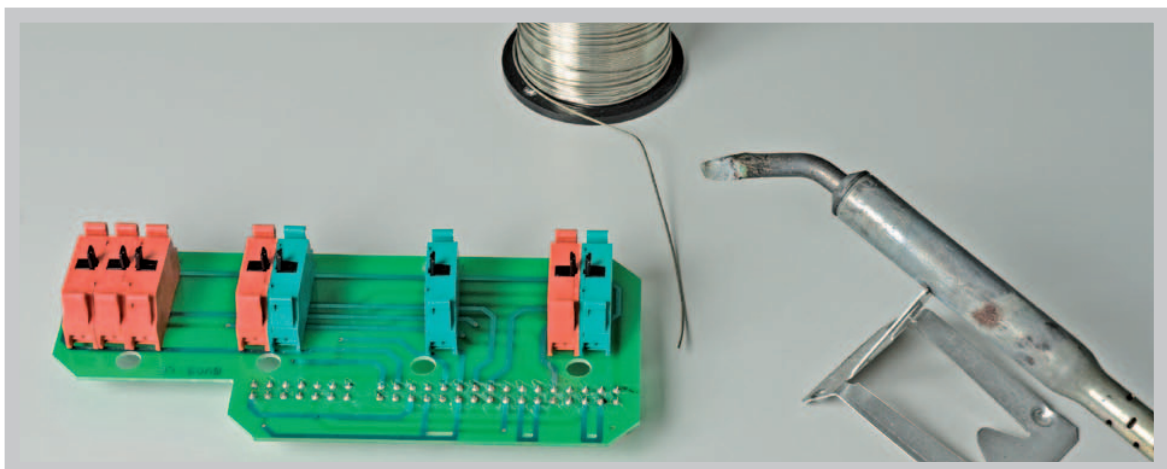

Pegasus



Contact blocks

Screw terminals



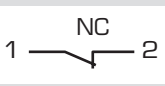

AUTOMATION TECHNOLOGIES

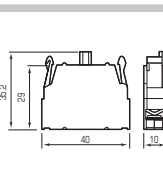
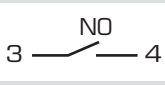
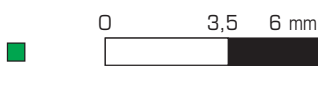
CONTACT BLOCKS

		CONTACT BLOCKS				
DESIGNATION	FUNCTIONS	CODE	DIMENSIONS			
			PL004001			
			PL004002			

LAMPHOLDER BA9s

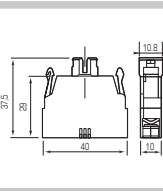
DESIGNATION	POWER SUPPLY	CODE	DIMENSIONS	
	 <p>BA9s lamp socket 250V 2,4 w max bulb not included</p>	PL004007		

LAMPHOLDER WITH BUILT-IN LED

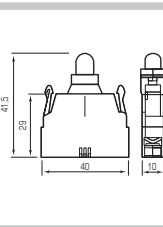
DESIGNATION	POWER SUPPLY	CODE	DIMENSIONS	
	AC/DC 12V	PL0045L12		
	AC/DC 24V	PL0045L24		
	AC/DC 48V	PL0045L48		
	AC/DC 110V	PL0045L110		
	AC 220V	PL0045L220		

POWER SUPPLY WITH DIODE AND RESISTORS

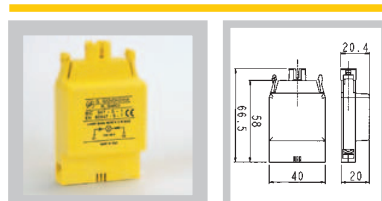

DESIGNATION	POWER SUPPLY	CODE
1 BA9s	110/130V Lamp 4B/60V -2W max	PL004RD1
	220/240V Lamp 110/130V -2W max	PL004RD2

POWER SUPPLY WITH TRANSFORMER

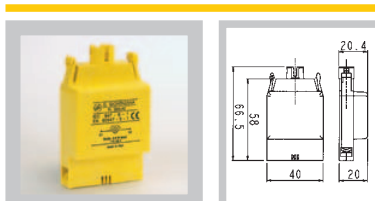

DESIGNATION	POWER SUPPLY	CODE
1 BA9s	Input 110/130V Output 24V	PL004TR1
	Input 220/240V Output 24V	PL004TR2
	Input 380/440V Output 24V	PL004TR3

POWER SUPPLY WITH FLASHING LIGHT

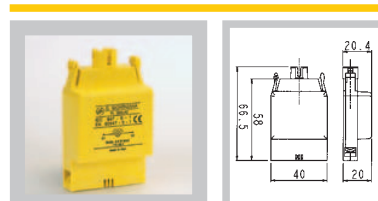

DESIGNATION	POWER SUPPLY	CODE
1 BA9s	24V Lamp 24V-2,6 max	PL004LA1
	110/130V 110/130V-2,6 max	PL004LA2

1 Lamp supply separately

X-ON Electronics

Largest Supplier of Electrical and Electronic Components

Click to view similar products for [Switch Hardware](#) category:

Click to view products by [Bernstein](#) manufacturer:

Other Similar products are found below :

[893102000](#) [LZZ1A](#) [0098.9234](#) [61-9707.7](#) [61-9771.0](#) [M2PA-5011](#) [635401](#) [6PA104](#) [6PA113](#) [6PA147-E6](#) [6PA148-E6](#) [6PA32](#) [6PA9](#) [700106](#)
[700109](#) [700201A56](#) [700303A56](#) [700701264](#) [700C1GRY](#) [700C2GRN](#) [704-6001](#) [704.960.4](#) [704.960.9](#) [704.965.1](#) [704.965.2](#) [704.965.6](#)
[704.966.0](#) [7089-3](#) [71M1048](#) [757200264](#) [778000A56](#) [79215938](#) [MHU35](#) [MHU37](#) [825.003.011](#) [825.005.011](#) [825.053.011](#) [825.055.011](#)
[826.000.071](#) [827.020.011](#) [827.400.021](#) [835.900.023](#) [MML52C10C](#) [MML52E10C](#) [MML72EEK](#) [MML92HGH](#) [MML93K](#) [84211M02CNNS](#)
[84211M02LGRS](#) [84211M02LNNX3](#)