

QO[®] and Homeline[®] Load Centers and Enclosures

Class 1100

Catalog
1100CT0501
2007



CONTENTS

Description	Page
QO [®] Circuit Breakers and Load Centers	3
QO [®] , QOM2 and Q-Frame Enclosed Circuit Breakers	34
Homeline [®] Circuit Breakers and Load Centers	40

QO® and Homeline® Load Centers and Enclosures

Table of Contents

TABLE OF CONTENTS

Product Description	3
Features	3
QO® Catalog Number Description	4
General information and Application Data	5
Service	5
Ratings	5
Branch Circuit Breakers	5
Indoor Enclosures (Type 1)	6
Indoor Covers	6
Rainproof Enclosures (Type 3R)	6
Bolt-On Hubs	6
Class CTL	7
Phasing	7
Line Lugs	7
Neutral Assemblies	7
Single Phase, 2 16 Circuits, 30 125 A, Fixed Mains	8
Single-Phase, 12 42 Circuits, 100 225 A, Convertible Mains	9
Special Purpose	11
Generator Panels	12
Three-Phase, 3 4 2 Circuits, 60 22 5 A, Convertible or Fixed Mains	13
Single-Phase, 12 42 Circuits, 300 400 A, Fixed Mains	15
Accessories	16
Technical Information	19
Grounding Bar Kits	19
Main Lugs and Main Circuit Breakers Ratings	20
Dimensions and Knockouts	26
QO 1-Phase and 3-Phase Label Samples	28 29
Wiring Diagrams	30

NOTE: For information on Replacement Parts with specific part numbers, go to www.schneider-electric.us, click on Product FAQ's, enter the device catalog number, click SEARCH, then look for the information required.

QO® and Homeline® Load Centers and Enclosures

Product Description

PRODUCT DESCRIPTION

QO® Circuit Breaker Load Centers from Square D® are Underwriters Laboratories (UL) Listed panelboards. They are designed to meet residential, commercial, and industrial requirements to protect electrical systems, equipment, and people.



QO® Circuit Breaker Load Center

Features

- Single- or three-phase construction
- 30 400 A main lug or main circuit breaker ratings
- 2 4 2 circuit indoor or outdoor versions
- Flush or surface mounting
- Aluminum bus construction on fixed mains panels
- Service entrance equipment capable panels
- Straight-in wiring to minimize service cable installation
- Convertible mains to meet changing job site requirements
- Standard 22/10 k AIR series rating on main circuit breaker panels, increasing application capability
- 65 k AIR ratings for main lugs panels for industrial applications
- 65 k AIR rating with optional main circuit breaker on three-phase panels for industrial applications
- Shielded one-piece plated copper bus construction on convertible mains panels, an industry exclusive for protection and performance
- Single captive screw interior mounting on indoor panels to ease removal
- Split branch neutral for clutter-free wiring
- Top or bottom feed by rotating convertible mains panels 180 degrees
- Top or bottom feed for three-phase convertible panels by removing main circuit breaker and rotating panel 180 degrees
- Combination slot/square drive neutral, ground, and cover screws for positive drive and improved torque
- Three grounding bar mounting locations for ease of wiring
- Automatic flush adjustment cover to speed installation
- Tangential main service knockouts that eliminate offsets
- Equipment grounding bar included with main lug load centers
- Covers sold separately
- Provisions for door lock on convertible mains panel covers
- Two branch circuit breaker twistouts that are factory removed for easier installation of circuit breakers
- Side hinge doors on outdoor convertible main panels
- Outdoor panel covers lockable with padlock
- Manual and automatic transfer switch capability

QO® and Homeline® Load Centers and Enclosures

Catalog Number Description

CATALOG NUMBER DESCRIPTION

QO® Load Centers

Number Segment	Character	Description	QO®	1	3040	L	200	G	—	—
Load Center Family	QO®	UL and NOM Listed								
	CQO	CSA® Certified								
Phase	1	Blank or 1 = Single 3 = Three								
Spaces / Circuits	3040									
Mains Type	M	Main circuit breaker								
	MX	Main circuit breaker for Automatic Transfer Switch								
	L	Main lugs								
	U	Universal mains (studs only)								
Amperes										
Grounding Bar	Blank	Purchase separately								
	G	Included								
	N	Neutral installed								
	T	Factory-installed								
Cover	Blank	Purchase cover separately								
	C	Combination flush / surface indoor cover								
	DF	Flush cover with door								
	DS	Surface cover with door								
	F	Flush cover								
	R	Rainproof								
	RB	Rainproof for B hub								
	S	Surface cover								
Special Construction	CU	Copper bussing								
	FT	Feed-thru lugs								
	GP	Generator panel								
	NM	Non-metallic enclosure								
	R	Generator receptacle								
	WG	Wide gutter riser panel								

QO® Circuit Breakers

Number Segment	Character	Description	QO®	1	15	—
Brand	QO	Full Size				
	QOT	Tandem				
Number of Poles						
Amperes						
Device Name	Blank	10,000 AIR				
	EPD	30 mA equipment ground fault protection				
	GFI	Ground fault circuit interruption				
	HID	For use on high intensity discharge lighting systems				
	HM	High magnetic trip circuit breakers are recommended for applications where high initial inrush current may occur				
	K	Key operated				
	PL	Remote control switching capability				
	SWN	Switch neutral common trip				
	VH	22,000 AIR				
	AFI	Arc fault circuit interruption				
CAFI	Combination arc fault circuit interruption					

QO® and Homeline® Load Centers and Enclosures

General Information and Application Data

GENERAL INFORMATION AND APPLICATION DATA



QO® Circuit Breaker Load Center

Circuit breaker load centers for use on electrical systems are UL Listed under File E-6294 (panelboards) and meet Federal Specifications W-P-115c, Type 1, Class 2 for use in government housing. Select from QO, QOT, QO-PL, QO-GFI (UL Class A ground fault protection), QO-AFI (arc fault circuit interrupter), QO-CAFI (combination arc fault interrupter), or QO-EPD (30 mA equipment ground fault protection) branch circuit breakers.

Service

120 Vac, 1 ϕ 2W	240/120 Vac delta, 3 ϕ 4W
120/240 Vac, 1 ϕ 3W	240 Vac corner grounded delta, 3 ϕ 3W
240 Vac delta, 3 ϕ 3W	48 Vdc maximum (1 ϕ convertible main lug 12 4 2 circuit only)
208Y/120 Vac, 3 ϕ 4W	

Ratings

	Main Lugs	Main Circuit Breaker
Single-Phase	30 400 A	100 4 00 A
Three-Phase	60 225 A	100 2 25 A

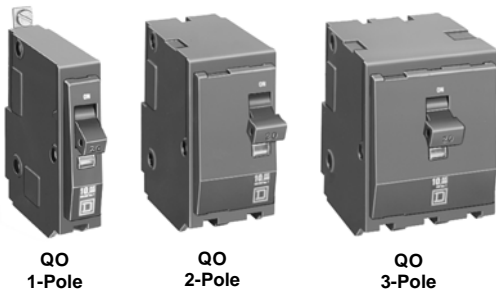

QO 1-Pole QO 2-Pole QO 3-Pole



QO-EPD 1-Pole

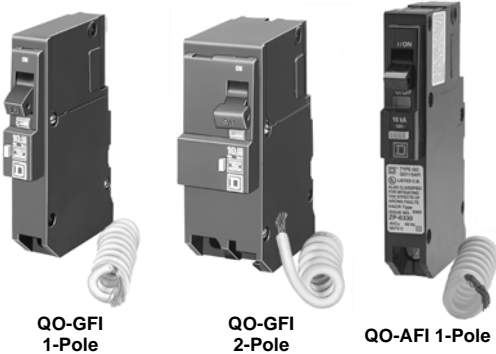

QO-GFI 1-Pole QO-GFI 2-Pole QO-AFI 1-Pole



QO-CAFI 1-Pole



QOK, 1-Pole



QO-SWN, 1-Pole

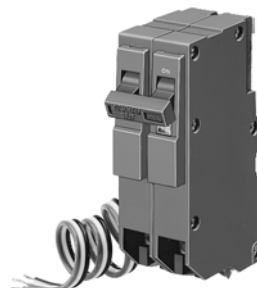

QO-PL 2-Pole

Branch Circuit Breakers

10,000 AIR	
QO	1-pole, 10 70 A
	2-pole, 10 12 5 A
	3-pole, 10 10 0 A
QOT	1-pole, 15 20 A
QO-EPD	1-pole, 15 30 A
	2-pole, 15 60 A
QO-GFI	1-pole, 15 30 A
	2-pole, 15 60 A
QO-AFI	1-pole, 15 20 A
QO-CAFI	1-pole, 15 20 A
QO-HID	1-pole, 15 50 A
	2-pole, 15 50 A
	3-pole, 15 30 A
QO-PL QO-PLILC	1-pole, 10 20 A, 30 A
	2-pole, 10 60 A
	3-pole, 15 60 A
QO-SWN	2-wire, 10 50 A
	3-wire, 10 50 A
QOK	1-pole, 10 30 A
22,000 AIR	
QO-VHGF1	1-pole, 15 30 A
QO-VH	1-pole, 15 30 A
	2-pole, 15 12 5 A
	3-pole, 15 10 0 A
QOB-VH	2-pole, 150 A ¹
	3-pole, 110 150 A ¹
42,000 AIR	
QOH	2-pole, 40 12 5 A
65,000 AIR	
QH	1-pole, 15 30 A
	2-pole, 15 30 A
	3-pole, 15 30 A

¹ For use with 300 A and 400 A load centers only. Requires PK3CA mounting kit, ordered separately.

QO® and Homeline® Load Centers and Enclosures

General Information and Application Data

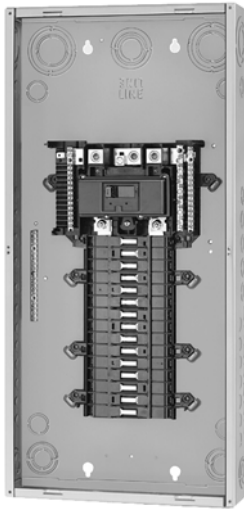

QO130M150



Indoor Cover



QO140M200RB



Bolt-On Hubs

Indoor Enclosures (Type 1)

Welded sheet steel with knockouts at top, bottom, back, and sides
Finish: gray baked enamel, electrodeposited over cleaned, phosphatized steel

Most 100 225 A indoor enclosures are 14.25 in. (362 mm) wide (see Dimensions and Knockouts on page 26)

300 A and 400 A indoor enclosures are 20 in. (508 mm) wide
Top or bottom feed by rotating enclosure

Indoor Covers

Doors to cover circuit breaker handles, except on 2 4, 4 8, 6 12 , and 8 16 circuit models

Shutter-type twistouts

Flush and surface covers available, sold separately

Flush covers have automatic flush adjustment

Field-installed door lock provisions available on most covers

QOFP filler plates available for all covers

QOM1FP filler plates available for 100 1 25 A convertible load center covers

QOM2FP filler plates available for 150 2 25 A convertible load center covers

Q2FP filler plates available for 3-phase load center covers

Triple lead cover screws for fast cover installation

Rainproof Enclosures (Type 3R)

Complete enclosure includes interior trim and door

Welded, galvanized steel

Finish: gray baked enamel, electrodeposited over cleaned, phosphatized, galvanized steel

RB devices have provisions for interchangeable bolt-on hub

Top-centered rainproof mounting boss on the back of the enclosure simplifies installation and saves time

Stainless steel door latch on the enclosure provides secure closure and maximum durability

Convertible main panels are side-hinge door devices

Allow 1.25 in. (32 mm) on the left side for the door to open

Side-hinged door provides full wiring access without door removal

Bolt-On Hubs

Hubs available from 0.75 in. (19 mm) to 4 in. (102 mm) conduit size

No gasket required with hubs from 0.75 in. (19 mm) to 2.50 in. (64 mm) when used on RB type load centers

QO[®] and Homeline[®] Load Centers and Enclosures General Information and Application Data

Class CTL

Class CTL load centers are UL Listed

Circuit breaker mounting rails have slots to accept tandem circuit breakers, on specified load centers

Meets paragraph 408.35 of the 2005 National Electrical Code[®] (NEC[®])



Tandem circuit breaker mounts on rails.

Phasing

Load centers have distributed phase bussing

Most branch circuit breakers can be mounted in any position

Line Lugs

All lugs suitable for 75 °C copper or aluminum wires (see Main Lugs and Main Circuit Breaker Ratings on page 20)

Main lugs and main circuit breaker load centers have wire binding screw torque values on the wiring diagrams and circuit breaker labels

Neutral Assemblies

All lugs suitable for copper or aluminum wire (see Main Lugs and Main Circuit Breaker Ratings on page 20)

Branch neutral terminals suitable for one #14 #4 AWG copper or one #12 #4 AWG aluminum wire

Three #14 1/0 AWG copper or #14 #6 AWG aluminum terminals provided on 12 42 circuits, 100 225 A load centers

Suitable lugs provided on the neutrals for termination of the grounding conductor

All unused neutral terminals may be used to terminate bare or green equipment grounding conductors when the load center is used as service equipment:

one or two #14 # 12 AWG copper

one or two #12 # 10 AWG aluminum

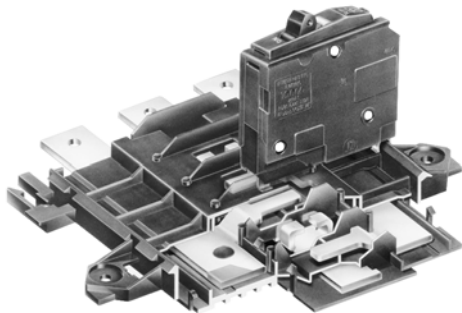

Branch Circuit Breaker



Neutral assemblies accept copper or aluminum wire.

QO[®] and Homeline[®] Load Centers and Enclosures

General Information and Application Data



QO24L70S

Single Phase, 2–16 Circuits, 30–125 A, Fixed Mains

UL Listed

File E-6294

Suitable for use as service equipment

75 °C wire rating (see Technical Information on page 20)

Federal Specification W-P-115c, Type 1, Class 2

CSA Certified

File LL-89066-21

For other CSA certified load centers, see Supplemental Digest 174.

Short Circuit Current Rating

UL short circuit current rating depends on lowest interrupting rating of circuit breaker installed (see Technical Information on page 20)

Interior

Tin plated aluminum bus

Tin plated copper bus is an available option on 6 12 and 8 16 circuit load centers

Tin plated copper bus is standard on 4 8 circuit load centers

Mains

Factory-installed main lugs

Top mains positioning only

Top or bottom feed

A backfed main circuit breaker can be field-installed in 4 8 , 6 12 and 8 16 load centers using the PK2MB retaining kit

Cover

Flush- or surface-mounted cover included with load centers

A cover with a door is an available option on 6 12 and 8 16 circuit load centers



QO816L100DS



QO148L125GF

QO® and Homeline® Load Centers and Enclosures General Information and Application Data

Single-Phase, 12–42 Circuits, 100–225 A, Convertible Mains

UL Listed

File E-6294

Federal Specification W-P-115c, Type 1, Class 2

Suitable for use as service equipment

75 °C wire rating (see Technical Information on page 20)

Short Circuit Current Rating

Main lugs: up to 65,000 AIR (depends on lowest interrupting rating of branch circuit breakers installed)

Main circuit breaker: 22,000 AIR standard

22,000 AIR main circuit breaker kits (refer to page 10 and Technical Information on page 20)

Interior

Shielded, one-piece tin plated copper bus

Removable interior with single, captive mounting screw

Split branch neutral with up to 50% more terminations than required

Multiple mounting locations for equipment grounding bar kits: left, right, and bottom

Main lugs load centers have equipment grounding bar kits included (not factory-installed)

Mains

Factory-installed main lugs convertible to main circuit breaker

Load Center Amperage	Main Circuit Breaker Kit Amperage
125	50 125
150	100 15 0
200	100 20 0
225	100 22 5

Factory-installed main circuit breaker convertible to main lugs

Main Circuit Breaker Amperage	Main Lug Kit Amperage	Load Center Amperage
100	125	100
125	125	125
150	225	150
200	225	200
225	225	225

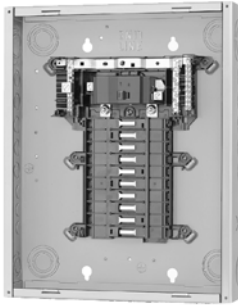

Main Circuit Breaker

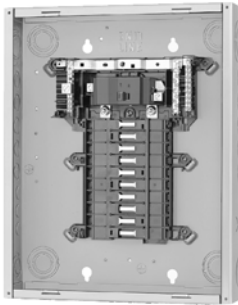

Main Lug

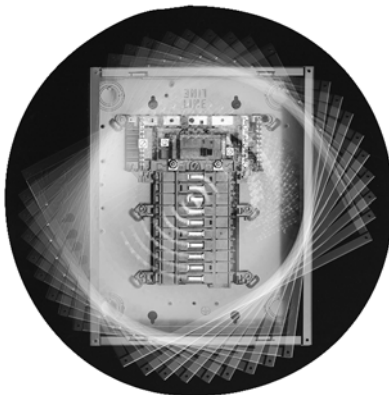

Top or bottom mains positioning. Rotate entire load center 180 degrees.

QO® and Homeline® Load Centers and Enclosures

General Information and Application Data



Cover



QOL125 Kit



QOL225 Kit

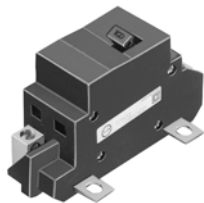

QOM1
Main Frame Size
50–125 A



QOM2
Main Frame Size
100–225 A

Single-Phase, 12–42 Circuits, 100–225 A, Convertible Mains, Continued

Covers

Flush and surface covers sold separately

Flush covers have spring-loaded interior trim for automatic flush adjustment

Positive action, easy-open door latch

Main Lugs Kits

Field-installable in main circuit breaker or main lugs load centers

QOL125 kit for use in 100 125 A load centers

QOL225 kit for use in 150 225 A load centers

Main Circuit Breaker Kits

Field-installable in main lugs or main circuit breaker load centers

50 2 25 A main circuit breaker kit is 22,000 AIR series rated with 10,000 AIR branch circuit breakers

Field-Installable Main Circuit Breaker (Convertible Main Load Centers Only)

Main Circuit Breaker Ampere Rating ¹	Use with Convertible Load Center Mains Rating	22,000 AIR	Lug Wire Size ² AWG/kcmil Al or Cu	Lug Torque lb-in. / N•m
		Main Circuit Breaker		

QOM1 Frame Size

50	100 125 A	QOM50VH	#12 2/0	50 lb-in. (6 N•m)
60	100 125 A	QOM60VH		
70	100 125 A	QOM70VH		
80	100 125 A	QOM80VH		
90	100 125 A	QOM90VH		
100	100 125 A	QOM100VH		
110	125 A	QOM110VH		
125	125 A	QOM125VH		

QOM2 Frame Size ^{3 4}

100	150 225 A	QOM2100VH	#4 30 0	250 lb-in. (28 N•m)
125	150 225 A	QOM2125VH		
150	150 225 A	QOM2150VH		
175	200 225 A	QOM2175VH		
200	200 225 A	QOM2200VH		
225	225 A	QOM2225VH		

¹ Do not exceed the load center mains rating.

² Wire range listed for QOM circuit breaker kits is the wire range of that circuit breaker. To find out maximum wire size permitted in a particular load center per UL, see Main Wire Size AWG/kcmil on page 20.

³ Add suffix 1021 for shunt trip.

⁴ Add suffix 8041 for control wire taps.

QO® and Homeline® Load Centers and Enclosures General Information and Application Data

Special Purpose



QO2L30TTS

Recreational Vehicle and Manufactured Housing Load Centers

- UL Listed (File E-6294) and CSA Certified (LL89066-14)
- Single-phase, 2- and 3-wire
- Factory-installed equipment grounding bar
- Covers included with load centers

Load Centers with Covers

- Combination flush/surface cover included with load centers
- Equipment grounding bar included on main lug load centers
- Top or bottom feed on incoming service by rotating complete load center 180 degrees
- Convertible main load centers

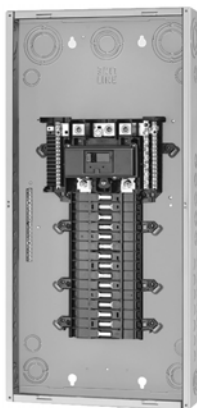

QO130M150

Non-Metallic Load Center

- UL Listed
- Suitable for use as service equipment
- Side-hinge door device
- 10,000 AIR rating
- Single-phase, 2- and 3-wire
- Factory-installed grounding bar
- Cover included with load center
- Knockouts in bottom endwall, side and back



QO24L60NRNM

Main Circuit Breaker with Feed-Thru Lugs

- Available rainproof enclosure only
- Side hinge door devices
- Allow 1.25 in. (32 mm) on the left side for the door to open
- 125, 150, and 200 A mains rating
- 125, 150, and 200 A feed-thru lugs
- Space for up to 8 single-pole circuit breakers



QO1816M200FTRB

QO[®] and Homeline[®] Load Centers and Enclosures

General Information and Application Data



QO48M60DSGP



QO[®] Intelligent Load Center



Wide Gutter

Generator Panels

Generator Panel Manual Transfer

- Connects utility and standby power to installed branch circuits
- Includes two factory-installed 2-pole main circuit breakers tied together with a mechanical interlock
- 30 A and 60 A main circuit breaker versions
- Supply up to 8 branch circuits using tandem circuit breakers
- Available indoor enclosure only
- Cover with door included

Generator Panel Automatic Transfer

- QO[®] load center platform construction
- Automatic transfer from utility to back-up power source
- Transfer cycle less than 10 seconds
- Indoor and outdoor enclosures
- 120 / 240 Vac single-phase
- 150, 200 and 225 A main circuit breaker
- 42 circuit maximum construction, indoor, 28 circuit maximum outdoor
- 125 A maximum branch feeder connection to an alternative energy source
- Service entrance rated
- Manual override capability
- Easy removal of interior and transfer switch for rough in wiring
- 5-year limited warranty
- Compatible with standard load center field-installable accessories

Riser Panels

- Offset interior provides ample wire gutter space for high rise applications
- Factory-installed main lugs (125 A), convertible to main circuit breaker with standard QOC cover and optional Mono-Flat cover
- Factory-installed main lugs (200 A), convertible to main circuit breaker when used with QOC cover only
- Available in 12 to 40 circuits
- Indoor only
- Optional Mono-Flat[®] cover available for both 125 A and 200 A panels (sold separately)

QO[®] and Homeline[®] Load Centers and Enclosures General Information and Application Data

Three-Phase, 3–42 Circuits, 60–225 A, Convertible or Fixed Mains

UL Listed

File E-6294

Suitable for use as service equipment

75 °C wire rating (see Technical Information on page 19)

Short Circuit Current Rating

Main lugs: up to 65,000 AIR (depends on lowest interrupting rating of branch circuit breakers installed)

Main circuit breaker up to 225 A: 22,000 AIR standard; optional up to 65,000 AIR for 100 A to 225 A main circuit breakers

Mains

Factory-installed main lugs or main circuit breaker

Main neutral terminal located next to the phase terminals on 125 2 25 A main circuit breaker devices

Top or bottom feed (see Technical Information on page 24)

Fully convertible from main circuit breaker to main lugs (100 225 A)

100 A maximum back-fed main QO[®] circuit breaker; requires the use of retaining kit PK3MB

Cover

Flush- and surface-mount covers sold separately

Flush covers have spring-loaded interior trim for automatic flush adjustment

Positive action, easy-to-open door latch

Interior

Shielded one-piece plated copper bus on 100 2 25 A

Removable interior with single, captive mounting screw on 100 22 5 A (indoor only)

Main lugs load centers have equipment grounding bar kits included (not factory-installed)

Branch Neutral Termination

Suitable for copper or aluminum wire

Terminals suitable for one #14 #4 AWG copper or one #12 #4 AWG aluminum wire

Positioned on both sides of the mains compartment

Slot/square drive wire binding screws

Three (3) #14 1/0 AWG copper or #14 #6 AWG aluminum terminations standard on 12 4 2 circuits, 100 22 5 A load centers

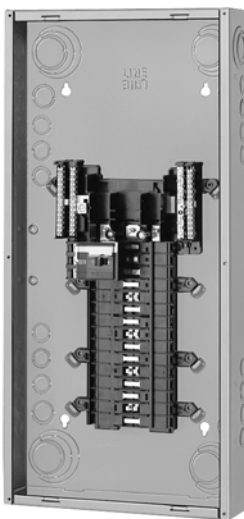

QO330L200G

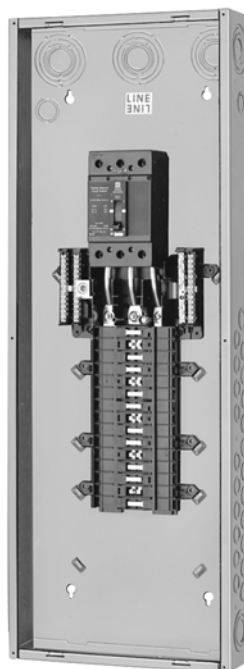

QO330MQ150

QO® and Homeline® Load Centers and Enclosures

General Information and Application Data

Three-Phase, 3–42 Circuits, 60–225 A, Convertible or Fixed Mains (Continued)

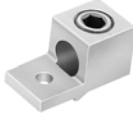
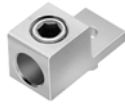

**QOL3225
Main Lugs Kit**



**QDL Circuit Breaker
70–225 A**

Main Lugs Kits

Field-installable in main circuit breaker or main lugs load centers

QOL3125 kit for use in 100 125 A load centers

QOL3225 kit for use in 150 225 A load centers

Main Circuit Breakers

Field-installable in main circuit breaker load centers

25,000 AIR QDL main circuit breakers series rated with 10,000 AIR QO® branch circuit breakers

100 225 A main circuit breakers are series rated up to 100,000 AIR (see table below) with 10,000 AIR branch circuit breakers in 30 circuit or larger main circuit breaker load centers with optional QJL main circuit breaker

Back-fed QO-VH (100 A maximum) main circuit breaker may be field installed in main lugs and main circuit breaker load centers (requires PK3MB retaining kit)

27 circuit, 100 A main circuit breaker load center includes factory-installed back-fed QO-VH main circuit breaker

Electrical accessories are not available on QDL, QGL, or QJL circuit breakers

30 4 2 circuit, 125 22 5 A main circuit breaker load centers include integral QDL circuit breakers. Optional QGL and QJL circuit breakers available as shown:

Amperage	25,000 AIR	65,000 AIR	100,000 AIR ¹
70	QDL32070	QGL32070	QJL32070
80	QDL32080	QGL32080	QJL32080
90	QDL32090	QGL32090	QJL32090
100	QDL32100	QGL32100	QJL32100
110	QDL32110	QGL32110	QJL32110
125	QDL32125	QGL32125	QJL32125
150	QDL32150	QGL32150	QJL32150
175	QDL32175	QGL32175	QJL32175
200	QDL32200	QGL32200	QJL32200
225	QDL32225	QGL32225	QJL32225

¹ When these 3-pole circuit breakers are used as the main circuit breaker of a three-phase load center, the maximum AIR rating is 65,000 at 240 Vac and 100,000 at 208 Vac.

QO[®] and Homeline[®] Load Centers and Enclosures General Information and Application Data

Single-Phase, 12–42 Circuits, 300–400 A, Fixed Mains

UL Listed

File E-6294

Suitable for use as service equipment

75 °C wire rating (see Technical Information on page 20)

Short Circuit Current Rating

Main lugs: up to 65,000 AIR

Main circuit breaker: 42,000 AIR fully rated (see Technical Information on page 20)

Mains

Factory-installed main lugs and main circuit breaker

Multiple wire terminals for phases and neutral

Top or bottom mains positioning (see Technical Information on page 20)

Cover

Flush- and surface-mount covers sold separately

Interior

Available in single-phase construction

Interiors accept QO[®] and QOB-VH 110 150 A maximum circuit breakers (QOB-VH circuit breakers require connector kit PK3CA)

Tin plated aluminum bus

Tin plated copper connector fingers

Neutral assemblies positioned opposite the mains compartment

Enclosures

20 in. (508 mm) wide galvanized steel

Embossed 0.25 in. (6 mm) standoffs

End walls, one blank and one with knockouts, are standard; both are removable and interchangeable

Embossed keyholes centered at both ends and in visual positioning

Multiple grounding bar mounting locations

Wire management braces

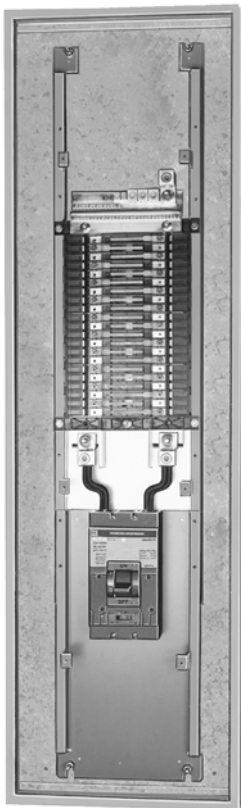

QON42MS400 and MH68

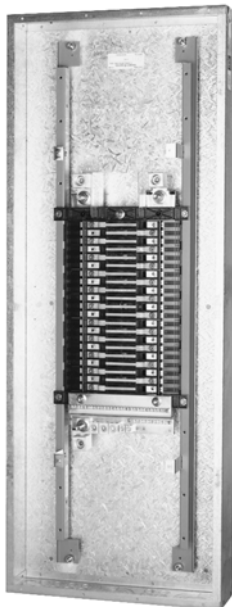

QON42LS400 and MH53

QO® Circuit Breaker Load Centers—Class 1130

General Information and Application Data

Accessories



PG18GTA Grounding Bar Kit



PK6FL Flush Lock Kit



PK4FL Flush Lock Kit

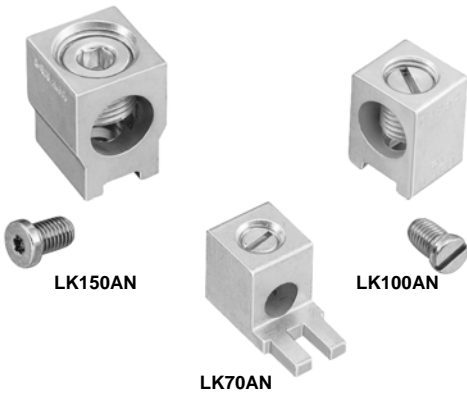

Auxiliary Neutral Lugs

Grounding Bar Kits

Field-installable in all load centers
 Same wire size as terminals (see page 19)
 Suitable for copper or aluminum wire
 Available with #1 4/0 lug PK15GTA-L, PK18GTA-L, and PK23GTA-L (see page 19)

Flush Lock Kits

Available for indoor load centers
 Two keys provided with each lock kit
 PK6FL for convertible 12 42 circuit load centers
 PK4FL for 300 and 400 A load centers

Auxiliary Neutral Lugs

UL Listed for copper or aluminum wire
 Field-installable on neutral assembly
 LK70AN:#12 # 2 AWG Al or #14 #4 AWG Cu
 LK100AN:#6 2 /0 AWG (Al/Cu)
 LK125AN:#14 2/0 AWG (Al/Cu)
 LK150AN:#2 3 /0 AWG (Al/Cu)
 LK225AN:#4 3 00 kcmil (Al/Cu), use ONLY in Series S, 150 22 5 A QO® or Homeline® load center

Cover Filler Plates

Fast to install, snap-in type
 QOFP branch circuit
 QOM1FP for 70 125 A, single-phase, main circuit breakers
 QOM2FP for 150 22 5 A, single-phase, main circuit breakers
 Q2FP for 125 225 A, three-phase, main circuit breakers

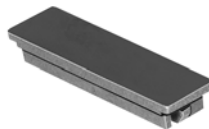

QOFP Cover Filler Plate

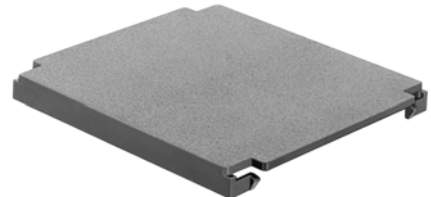

Q2FP Cover Filler Plate

QO[®] and Homeline[®] Load Centers and Enclosures General Information and Application Data

Accessories (Continued)

Surgebreaker[®] Secondary Surge Arrester

QO2175SB UL Listed secondary surge arrester

Easy plug-on installation for QO[®] load centers

LED indicates operational status

Plug-on design requires two pole spaces

Designed to protect electrical service and major household appliances , excluding electronic devices



QO2175SB



Back-fed Main Circuit Breaker Retaining Kit (PK4MB2LA)

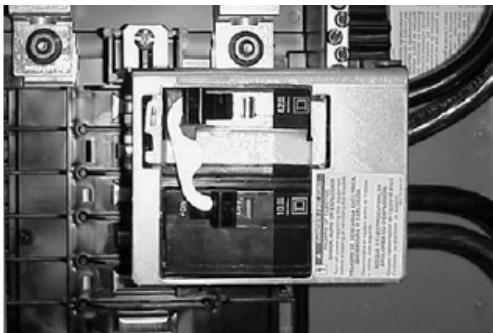

QO Manual Transfer Equipment Kit (PK4DTIM4HA)



Generator Interlock Kit Installed

Back-Fed Main Circuit Breaker Retaining Kits

Back-fed main circuit breaker retaining kits secure 2-pole, 10 125 A circuit breakers to single-phase or three-phase mains interiors when used as back-fed main circuit breakers. Mounting of retaining kits is based on top-feed applications.

Catalog No.	Description
PK2MB	QO 6 1 2, 4 8, and 8 16 load centers
PK3MB	Three-phase load centers
PK4MB2LA	Mounts on the right side of QO single-phase, 100 125 A convertible main load center, series S01 and S02. Retains one 2-pole QO circuit breaker with or without electrical accessories.
PK4MB2HA	Mounts on the right side of QO single-phase, 150 225 A convertible main load center, series S01 and S02. Retains one 2-pole QO circuit breaker with or without electrical accessories.

UL Listed Manual Transfer Equipment Kits

Manual transfer equipment kits secure two 2-pole, 10 125 A circuit breakers.

Catalog No.	Description
QO2DTI	For interlocking the handles of two 2-pole or one 2-pole and one 1-pole QO and Q1 circuit breakers mounted side-by-side so that only one circuit breaker can be ON at a time.
QO2DTIM	QO2DTI mechanical interlock attachment with retaining kits for securing two adjacent back-fed circuit breakers in dual power supply applications. Can be used with two 2-pole or one 2-pole and one 1-pole QO circuit breakers in QO816L100 load centers.
PK4DTIM4LA	Mounts on the right side of QO single-phase, 100 125 A convertible main load center, series S01 and S02. Retains two 2-pole QO circuit breakers with a QO2DTI kit included for dual power supply applications.
PK4DTIM4HA	Mounts on the right side of QO single-phase, 150 225 A convertible main load center, series S01 and S02. Retains two 2-pole QO circuit breakers with a QO2DTI kit included for dual power supply applications.
PK4DTIM4LAL	Mounts on the left side of QO single-phase, 100 1 25 A convertible main load center, series S01 and S02. Retains two 2-pole QO circuit breakers with a QO2DTI kit included for dual power supply applications.

Generator Circuit Breaker Interlock Kit

Catalog No.	Description
QOCRBGK1	For use on "G" and "S" Series NEMA Type 1 and "G", "S1" and "S2" Series NEMA Type 3R load centers. Interlocks a QOM1, 2-pole main circuit breaker of a load center (100-125 A) with a QO, 2-pole (15-125 A) branch circuit breaker. Includes a retaining kit.
QOCGK2	For use on G and S Series NEMA Type 1 and G and S1 Series NEMA Type 3R load centers. Interlocks a QOM2, 2-pole main circuit breaker of a load center (150 22 5 A) with a QO 2-pole (15 12 5 A) branch circuit breaker. Includes a retaining kit.
QORBKG2	For use on S2 Series NEMA Type 3R load centers. Interlocks a QOM2 2-pole main circuit breaker of a load center (150 225 A) with a QO 2-pole (15 1 25 A) branch circuit breaker. Includes a retaining kit.

QO® Circuit Breaker Load Centers—Class 1130

General Information and Application Data



SDAG26
With Tap Kits Installed



Tap Kit with Mechanical Lugs

Tap Kit for Crimp Lugs



RB Hub

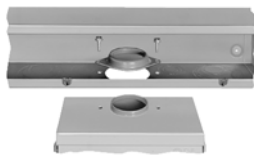

BC200 Enclosure Coupling

Accessories (Continued)

Auxiliary Gutters and Tap Kits

Field-installable on the left or right side of load centers

Auxiliary gutters are 13.50 in. wide x 26.12 in. height x 3.75 in. deep

Conduit riser sizes: 1-3/4, 2, 2-1/2 or 3 in. (3 in. requires use of B300 bolt-on hubs)

Flush cover included with auxiliary gutter

Tap kits required for each riser wire to be tapped (see below for tap kits)

Wire range on tap kits is #4 AWG to 300 kcmil copper or aluminum

Tap kits include mechanical-type lugs or studs for crimp-type lugs

Crimp-type lugs not included in tap kits (order separately)

Auxiliary Gutter (SDAG26) to Load Center Catalog Number Reference

QO® Single-Phase	QO112L125G	QO112M100
	QO11224L125G	QO116M100
	QO112L125GC	QO120M100
	QO11224L125GC	QO124M100
	QO116L125G	QO124M125
	QO11624L125G	QO112M100C
	QO120L125G	QO11220M100C
	QO12024L125G	QO116M100C
	QO124L125G	QO120M100C
	QO120L125GC	
QO® Three-Phase	QO312L125G	
	QO320L125G	
	QO324L125G	

Tap Kits

UL Listed for Use with Auxiliary Gutter SDAG26

Catalog Number	Riser Wire		Tap Off Wire	
	Lug Type	Wire Size	Lug Type	Wire Size
SDGT30020	Mechanical	(2) #6 AWG 3 00 kcmil	Mechanical	(1) #6 AWG 2 /0 AWG
SDGT300300	Mechanical	(2) #6 AWG 3 00 kcmil	Mechanical	(1) #6 AWG 30 0 kcmil
SDGT300C10C	Crimp	(2) #4 AWG 3 00 kcmil	Crimp	(1) #8 AWG 1 /0 AWG
SDGT300C300C	Crimp	(2) #4 AWG 3 00 kcmil	Crimp	(1) #4 AWG 30 0 kcmil
QOGL20 (grounding lugs)	Mechanical	(2) #6 AWG 2/0 AWG		

Auxiliary Gutter

UL Listed for Use with Standard Load Centers for Riser Applications

	SDAG26	Flush	No	N/A	See Tap Kit			No
--	--------	-------	----	-----	-------------	--	--	----

Bolt-On Hubs

Equipment with an RB suffix, meaning Rainproof Type 3R construction, uses the bolt-on hubs listed below. RB devices will accept 0.75 in. (19 mm) through 2.50 in. (64 mm) bolt-on hubs without the use of reducers. Off-center conduit thread openings and elongated mounting holes provide quick and easy adjustment to eliminate costly conduit offsets and bends. Hubs are suitable for use with conduit having ANSI standard taper pipe thread.

UL Listed Bolt-On Hubs for RB Devices

Conduit Size	0.75 in. 19 mm	1.00 in. 25 mm	1.25 in. 32 mm	1.50 in. 38 mm	2.00 in. 51 mm	2.50 in. 64 mm
Hub Cat. No.	B075	B100	B125	B150	B200	B250

NOTE: Closing cap (catalog number B-CAP) is provided factory-installed on each device having the RB suffix.

UL Listed Enclosure Coupling for RB Devices

Cat. No.	Designed for connecting wireway or other enclosures to units having RB bolt-on conduit provisions. Provides a bushed opening equal to 2 inch conduit. Eliminates the need for conduit nipling.
BC200	

QO® and Homeline® Load Centers and Enclosures Technical Information

TECHNICAL INFORMATION

Grounding Bar Kits

All PK equipment grounding kits are supplied with mounting screws, necessary installation instructions, and an Equipment Grounding Terminal self-adhesive label.

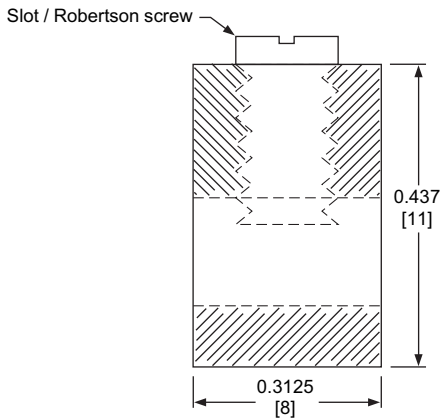

Cross Section of Size 1 Ground Bar

Dimensions: in.
[mm]

Catalog Number	Total Qty.	Terminals						Approximate Overall Length		Distance Between Mounting Holes		Mounting
		Quantity Each Size See "Wire Range Table" below.						in.	mm	in.	mm	
		I	II	III	IV	V	VI					
PK0GTA2 ¹	2						2	1.75	44	One hole	One hole	Top
PK0GTA6 ²	6					6		4.61	117	1.69	43	Top
PK3GTA1 ³	3	3						1.38	35	One hole	One hole	Top
PK4GTA ³	4	4						1.63	41	One hole	One hole	Top
PK5GTA ⁴	5	5						2.25	57	1.25	32	Top
PK7GTA ³	7	7						2.88	73	1.25	32	Top or side
PK9GTA1 ³	9	9						3.25	83	One hole	One hole	Top
PK9GTA ³	9	9						3.78	96	3.13	80	Top
PK12GTA ³	12	12						4.70	119	3.13	80	Top
PK15GTA ³	15	15						5.63	143	3.13	80	Top
PK15GTAL ⁵	16	15	1					8.13	207	3.13	80	Top
PK15GTA6 ⁶	21	15			6			5.88	149	7	7	Top
PK18GTA ³	18	18						6.56	167	3.13	80	Top
PK18GTAL ⁵	19	18	1					8.81	224	3.13	80	Top
PK23GTA ³	23	23						8.11	206	3.13	80	Top
PK23GTAL ⁵	24	23	1					9.44	240	3.13	80	Top
PK27GTA ^{3 8}	27 or 26	27 or 26		1				9.36	238	3.13	80	Top

¹ Mounting screw 40205-065-01 (one required).

² Mounting screw 21922-18360 (two required).

³ Mounting screw 21594-14220 (two required).

⁴ Mounting screw 21594-14241 (two required).

⁵ Mounting screw 21594-14302 (two required).

⁶ Mounting screws 21594-14241 (two required) and 21594-17121 (two required).

⁷ 3.13 in. (80 mm) on small terminals; 5.25 in. (133 mm) on large terminals.

⁸ PK27GTA includes one main grounding lug that mounts with two terminal screws and requires three terminals for mounting.

Size	Cu (AWG)	Al (AWG)
I	(1) #14 #4 or (2) #14 or #12	(1) #12 #4 or (2) #12 or #10
II	(1) #1 4/0	(1) #1 4/0
III	(1) #6 2/0	(1) #6 2/0
IV	(1) #6 3/0	(1) #6 3/0
V	(1) #14 1/0	(1) #14 1/0
VI	(1) #10 2/0	(1) #6 2/0

QO® Circuit Breaker Load Centers—Class 1130

Technical Information

Main Lugs and Main Circuit Breaker Ratings

Single-Phase, Three-Wire, 120/240 Vac; Main Lugs Indoor

Mains Rating in Amps	Load Center Catalog Number	Load Center Cover Catalog Number	UL Listed Service Equipment (See notes)	Maximum UL Short Circuit Rating ¹	Main Wire Size AWG/kcmil Al/Cu	Enclosure No. (Page 26)	Top or Bottom Mains Position	UL Listed for Corner Grounded Delta Systems
----------------------	----------------------------	----------------------------------	---	--	--------------------------------	-------------------------	------------------------------	---

Fixed Mains – Factory-Installed Main Lugs

30	QO2L30S	Included	No	10,000 A	#12 10 Al #14 10 Cu	1	Top	No
70	QO24L70F/S	Included	B	10,000 A	#12 3 Al #14 4 Cu	2	Top	No
100	QO612L100F/S	Included	B, C	10,000 A	#8 1	4	Top	No
	QO612L100DF/S	Included	B, C	10,000 A	#8 1	4	Top	
	QO612L100DFCU/SCU	Included	B, C	10,000 A	#8 1	4	Top	
100	QO816L100F/S	Included	B, C	10,000 A	#8 1	4	Top	No
	QO816L100DF/S	Included	B, C	10,000 A	#8 1	4	Top	
	QO816L100DFCU/SCU	Included	B, C	10,000 A	#8 1	4	Top	
125	QO148L125GF/S	Included	B, C	10,000 A	#12 2/0 Al #14 2/0 Cu	21	Top	No

Convertible Mains – Factory-Installed Main Lugs

QOM1 Main Frame Size – Convertible to Main Circuit Breaker – Copper Bus

125	QO112L125G	QOC16UF/S	B, C	65,000 A ^{2 3}	#6 2/0	6	Both	Yes
	QO11224L125G	QOC16UF/S	B, C	65,000 A ^{2 3}	#6 2/0	6	Both	
	QO116L125G	QOC24UF/S	B, C	65,000 A ^{2 3}	#6 2/0	7	Both	
	QO11624L125G	QOC24UF/S	B, C	65,000 A ^{2 3}	#6 2/0	7	Both	
	QO120L125G	QOC24UF/S	B	65,000 A ^{2 3}	#6 2/0	7	Both	
	QO12024L125G	QOC24UF/S	B	65,000 A ^{2 3}	#6 2/0	7	Both	
	QO124L125G	QOC24UF/S	B	65,000 A ^{2 3}	#6 2/0	7	Both	
	QO132L125G	QOC32UF/S	B	65,000 A ^{2 3}	#6 2/0	8	Both	

Convertible Mains – Factory-Installed Main Lugs

QOM2 Main Frame Size – Convertible to Main Circuit Breaker – Copper Bus

150	QO12030L125G	QOC30UF/S	B, C	65,000 A ^{2 3}	#6 25 0	9	Both	Yes
	QO124L150G	QOC30UF/S	B, C	65,000 A ^{2 3}	#6 25 0	9	Both	
	QO130L150G	QOC30UF/S	B, C	65,000 A ^{2 3}	#6 25 0	9	Both	
200	QO112L200G	QOC30UF/S	B, C	65,000 A ^{2 3}	#6 25 0	9	Both	Yes
	QO12436L200TFT	QOC40UF/S	B, C	65,000 A ^{2 3}	#6 25 0	10	Both	
	QO130L200G	QOC30UF/S	B, C	65,000 A ^{2 3}	#6 25 0	9	Both	
	QO13040L200G	QOC30UF/S	B, C	65,000 A ^{2 3}	#6 25 0	9	Both	
225	QO140L200G	QOC40UF/S	B, C	65,000 A ^{2 3}	#6 25 0	10	Both	Yes
	QO142L225G	QOC42UF/S	B	65,000 A ^{2 3}	#6 30 0	11	Both	

Fixed Mains – Factory-Installed Main Lugs

400	QON12LS400 (Interior)	MHC50VF/S	C	65,000 A ⁴	(1)1/0 750	15	Both	Yes
	MH50 (Enclosure)				(2)1/0 300			
	QON30LS400 (Interior)	MHC50QVF/S	No	65,000 A ⁴	(1)1/0 750	15	Both	Yes
	MH50 (Enclosure)				(2)1/0 300			
	QON42LS400 (Interior)	MHC53QVF/S	No	65,000 A ⁴	(1)1/0 750	17	Both	Yes
	MH53 (Enclosure)				(2)1/0 300			

¹ Short circuit current rating depends on lowest AIR rating of main or branch circuit breaker installed.

² UL Listed for 5000 A rms symmetrical short circuit rating when used in 3-phase, 240 Vac, corner grounded Delta systems, when used as main lugs load center **only**. Use 240 Vac circuit breakers only.

³ 22,000 A rms symmetrical maximum when supplied by integral type QOM-VH main circuit breaker from Square D® with 22,000 A rms symmetrical minimum interrupting rating and when all installed QO® branch circuit breakers have 10,000 A rms symmetrical minimum interrupting rating.

⁴ UL Listed for 5000 A rms symmetrical short circuit rating when used on 3-phase, 240 Vac, corner grounded Delta systems. Use 240 Vac circuit breakers only.

B UL Listed as suitable for use as service equipment (neutral bonded at the time of installation) with field-installed service disconnect.

C UL Listed as suitable for use as service equipment (neutral bonded at the time of installation) when not more than six service disconnecting means are provided and when not used as a lighting and appliance branch circuit panelboard.

QO[®] and Homeline[®] Load Centers and Enclosures Technical Information

Single-Phase, Three-Wire, 120/240 Vac; Main Circuit Breaker Ind oor

Mains Rating in Amps	Load Center Catalog Number	Load Center Cover Catalog Number	UL Listed Service Equipment (See Notes)	Maximum UL Short Circuit Rating ¹	Main Wire Size AWG/kcmil Al/Cu	Enclosure No. (Page 26)	Top or Bottom Mains Position	UL Listed for Corner Grounded Delta Systems
----------------------	----------------------------	----------------------------------	---	--	--------------------------------	-------------------------	------------------------------	---

Convertible Mains – Factory-Installed Main Circuit Breaker

QOM1 Main Frame Size – Convertible to Main Lugs or Lower Amperage Main Circuit Breaker – Copper Bus

100	QO112M100	QOC12UF/S	A, B	22,000 A ²	#4 1	5	Both	No
	QO116M100	QOC20U100F/S	A, B	22,000 A ²	#4 1	6	Both	
	QO120M100	QOC20U100F/S	A, B	22,000 A ²	#4 1	6	Both	
	QO124M100	QOC24UF/S	A, B	22,000 A ²	#4 1	7	Both	
	QO132M100	QOC32UF	A, B	22,000 A ²	#4 1	8	Both	
125	QO124M125	QOC24UF/S	A, B	22,000 A ²	#4 2/0	7	Both	No
	QO132M125	QOC32UF	A, B	22,000 A ²	#4 2/0	8	Both	

Convertible Mains – Factory-Installed Main Circuit Breaker

QOM2 Main Frame Size – Convertible to Main Lugs or Lower Amperage Main Circuit Breaker – Copper Bus

150	QO12030M150	QOC30UF/S	A, B	22,000 A ²	#4 250	9	Both	No
	QO124M150	QOC30UF/S	A, B	22,000 A ²	#4 250	9	Both	
	QO130M150	QOC30UF/S	A, B	22,000 A ²	#4 250	9	Both	
	QO132M150	QOC40UF/S	A, B	22,000 A ²	#4 250	10	Both	
200	QO12040M200	QOC30UF/S	A, B	22,000 A ²	#4 250	9	Both	No
	QO124M200	QOC30UF/S	A, B	22,000 A ²	#4 250	9	Both	
	QO130M200	QOC30UF/S	A, B	22,000 A ²	#4 250	9	Both	
	QO13040M200	QOC30UF/S	A, B	22,000 A ²	#4 250	9	Both	
	QO140M200	QOC40UF/S	A, B	22,000 A ²	#4 250	10	Both	
	QO142M200	QOC42UF/S	A, B	22,000 A ²	#4 250	11	Both	
225	QO140M225	QOC42UF/S	A, B	22,000 A ²	#4 300	11	Both	No
	QO142M225	QOC42UF/S	A, B	22,000 A ²	#4 300	11	Both	

Fixed Mains – Factory-Installed Main Circuit Breaker

300	QON42MS300	MHC68VF/S	A	42,000 A ³	(1)#4 500	16	Both	Yes
	MH68 (Enclosure)				(2)#4 3 /0			
400	QON42MS400	MHC68VF/S	A	42,000 A ³	(1)#4 600	16	Both	Yes
	MH68 (Enclosure)				(2)#4 250			

¹ Short circuit current rating depends on lowest AIR rating of main or branch circuit breaker installed.

² 22,000 A rms symmetrical maximum when supplied by integral type QOM-VH main circuit breaker from Square D[®] with 22,000 A rms symmetrical minimum interrupting rating and when all installed QO[®] branch circuit breakers have 10,000 A rms symmetrical minimum interrupting rating, 65,000 A rms symmetrical maximum when main lugs kits are installed.

³ UL Listed for 5000 A rms symmetrical short circuit current rating when used in 3-phase, 240 Vac, corner grounded Delta systems. Use 240 Vac circuit breakers only.

A UL Listed as suitable for use as service equipment (neutral bonded at the time of installation) with factory-installed service disconnect.

B UL Listed as suitable for use as service equipment (neutral bonded at the time of installation) with field installed main lugs when not more than six disconnecting means are provided and when not used as a lighting and appliance branch circuit panelboard. See NEC Article for Lighting and Appliance Branch Circuit Panelboard.

QO[®] and Homeline[®] Load Centers and Enclosures

Technical Information

Single-Phase, Three-Wire, 120/240 Vac; Main Lugs Rainproof

Mains Rating in Amps	Load Center Catalog Number	Load Center Cover Catalog Number ¹	UL Listed Service Equipment (See Notes)	Maximum UL Short Circuit Rating ²	Main Wire Size AWG/kcmil Al/Cu	Enclosure No. (Page 27)	Top or Bottom Mains Position	UL Listed for Corner Grounded Delta Systems
----------------------	----------------------------	---	---	--	--------------------------------	-------------------------	------------------------------	---

Fixed Mains – Factory-Installed Main Lugs

40	QO2L40RB	Included	B	10,000 A	#12 6 #14 10	1R	Top	No
60	QO24L60NRNM	Included	B	10,000 A	#14 4	1NM	Top	No
70	QO24L70RB	Included	B	10,000 A	#12 3 #14 4	1R	Top	No
100	QO612L100RB	Included	B, C	10,000 A	#8 1	2R	Top	No
	QO612L100TRB	Included	B, C	10,000 A	#8 1	2R	Top	
	QO612L100RBCU	Included	B, C	10,000 A	#8 1	2R	Top	
100	QO816L100RB	Included	B, C	10,000 A	#8 1	2R	Top	No
	QO816L100RBCU	Included	B, C	10,000 A	#8 1	2R	Top	
125	QO148L125GRB	Included	B, C	10,000 A	#12 2/0 #14 2/0	15R	Top	No

Convertible Mains – Factory-Installed Main Lugs

QOM1 Main Frame Size – Convertible to Main Circuit Breaker – Copper Bus

125	QO112L125GRB	Included	B, C	65,000 A ^{3 4}	#6 2/0	3R	Top	Yes
	QO11224L125GRB	Included	B, C	65,000 A ^{3 4}	#6 2/0	3R	Top	
	QO11624L125GRB	Included	B, C	65,000 A ^{3 4}	#6 2/0	4R	Top	
	QO124L125GRB	Included	B, C	65,000 A ^{3 4}	#6 2/0	4R	Top	

Convertible Mains – Factory-Installed Main Lugs

QOM2 Main Frame Size – Convertible to Main Circuit Breaker – Copper Bus

150	QO130L150GRB	Included	B, C	65,000 A ^{3 4}	#6 250	6R	Top	Yes
200	QO112L200GRB	Included	B, C	65,000 A ^{3 4}	#6 250	5R	Top	Yes
	QO130L200GRB	Included	B, C	65,000 A ^{3 4}	#6 250	6R	Top	
	QO13040L200GRB	Included	B, C	65,000 A ^{3 4}	#6 250	6R	Top	
	QO140L200GRB	Included	B, C	65,000 A ^{3 4}	#6 250	7R	Top	
225	QO142L225GRB	Included	B, C	65,000 A ^{3 4}	#6 300	8R	Top	Yes

¹ Convertible mains load center has a side-hinge door. Allow 1.25 in. (32 mm) on the left side for the door to open.

² Short circuit current rating depends on lowest AIR rating of main or branch circuit breaker installed.

³ UL Listed at 5000 A rms symmetrical short circuit current rating when used in 3-phase, corner grounded, Delta systems, when used as main lugs load center **only**. Use 240 Vac circuit breakers only.

⁴ 22,000 A rms symmetrical maximum when supplied by integral type QOM-VH main circuit breaker from Square D[®] with 22,000 A rms symmetrical minimum interrupting rating and when all QO[®] installed branch circuit breakers have 10,000 A rms symmetrical minimum interrupting rating.

B UL Listed as suitable for use as service equipment (neutral bonded at the time of installation) with field-installed service disconnect.

C UL Listed as suitable for use as service equipment (neutral bonded at the time of installation) when not more than six service disconnecting means are provided and when not used as a lighting and appliance branch circuit panelboard. See NEC Article for Lighting and Appliance Branch Circuit Panelboard.

QO® and Homeline® Load Centers and Enclosures Technical Information

Single-Phase, Three-Wire, 120/240 Vac; Main Circuit Breaker Rainproof

Mains Rating in Amps	Load Center Catalog Number	Load Center Cover Catalog Number ¹	UL Listed Service Equipment (See Notes)	Maximum UL Short Circuit Rating ²	Main Wire Size AWG/kcmil Al/Cu	Enclosure No. (Page 27)	Top or Bottom Mains Position	UL Listed for Corner Grounded Delta Systems
----------------------	----------------------------	---	---	--	--------------------------------	-------------------------	------------------------------	---

Convertible Mains – Factory-Installed Main Circuit Breaker

QOM1 Main Frame Size – Convertible to Main Lugs or Lower Amperage Main Circuit Breaker – Copper Bus

100	QO112M100RB	Included	A, D	22,000 A ³	#6 2/0	3R	Top	No
	QO116M100RB	Included	A, D	22,000 A ³	#6 2/0	4R	Top	
	QO120M100RB	Included	A, D	22,000 A ³	#6 2/0	4R	Top	
125	QO124M125RB	Included	A, D	22,000 A ³	#6 2/0	4R	Top	No

Convertible Mains – Factory-Installed Main Circuit Breaker

QOM2 Main Frame Size – Convertible to Main Lugs or Lower Amperage Main Circuit Breaker – Copper Bus

150	QO12030M150RB	Included	A, D	22,000 A ³	#4 250	5R	Top	No
	QO130M150RB	Included	A, D	22,000 A ³	#4 250	6R	Top	
200	QO12040M200RB	Included	A, D	22,000 A ³	#4 250	5R	Top	No
	QO130M200RB	Included	A, D	22,000 A ³	#4 250	6R	Top	
	QO140M200RB	Included	A, D	22,000 A ³	#4 250	7R	Top	

Convertible Mains – Factory-Installed Main Circuit Breaker with Feed-Thru Lugs

QOM1/QOM2 Frame Size – Convertible to Main Lugs or Lower Amperage Main Circuit Breaker – Copper Bus

125	QO1612M125FTRB ⁴	Included	A, D	22,000 A ³	#4 2/0	3R	Top	No
150	QO1816M150FTRB ⁴	Included	A, D	22,000 A ³	#4 250	6R	Top	No
200	QO1816M200FTRB ⁴	Included	A, D	22,000 A ³	#4 250	6R	Top	No

¹ Convertible mains load center has a side-hinge door. Allow 1.25 in. (32 mm) on the left side for the door to open.

² Short circuit current rating depends on lowest AIR rating of main or branch circuit breaker installed.

³ 22,000 A rms symmetrical maximum when supplied by integral type QOM-VH main circuit breaker from Square D® with 22,000 A rms symmetrical minimum interrupting rating and when all installed QO® branch circuit breakers have 10,000 A rms symmetrical minimum interrupting rating. 65,000 A rms symmetrical maximum when main lug kits installed.

⁴ QO1612M125FTRB provided with QOM1 frame main circuit breaker. QO1816M150/200FTRB provided with QOM2 frame main circuit breaker.

A UL Listed as suitable for use as service equipment (neutral bonded at time of installation) with factory-installed service disconnect.

D UL Listed as suitable for use as service equipment (neutral bonded at the time of installation) with field-installed main lugs when not more than six service disconnecting means are provided and when not used as a lighting and appliance branch circuit panelboard. See NEC Article for Lighting and Appliance Branch Circuit Panelboard.

QO® Circuit Breaker Load Centers—Class 1130

Technical Information

3-Phase, 4-Wire, 208Y/120 Vac; 3-Phase, 4-Wire, 240/120 Vac, Delta;
3-Phase, 3-Wire, 240 Vac, Delta; Main Lugs, Main Circuit Breaker In door

Mains Rating in Amps	Load Center Catalog Number	Load Center Cover Catalog Number	UL Listed Service Equipment (See Notes)	Maximum UL Short Circuit Rating ¹	Main Wire Size AWG/kcmil Al/Cu	Enclosure No. (Page 26)	Top or Bottom Mains Position	UL Listed for Corner Grounded Delta Systems
----------------------	----------------------------	----------------------------------	---	--	--------------------------------	-------------------------	------------------------------	---

Fixed Mains – Factory-Installed Main Lugs – Copper Bus

60	QO403L60NF/S	Included	B	22,000 A ¹		#10-6	13	Top	No
125	QO312L125G ²	QOC16UF/S	B, C	65,000 A ¹	#6 2 / 0	#6 2 / 0	6	Both	No
	QO320L125G ²	QOC24UF/S	B, C	65,000 A ¹	#6 2 / 0	#6 2 / 0	7	Both	
	QO324L125G ²	QOC24UF/S	B, C	65,000 A ¹	#6 2 / 0	#6 2 / 0	7	Both	
200	QO318L200G ²	QOC30UF/S	B, C	65,000 A ¹	#6 250	#6 2 50	9	Both	No
	QO330L200G ²	QOC30UF/S	B, C	65,000 A ¹	#6 250	#6 2 50	9	Both	
225	QO342L225G ²	QOC42UF/S	B	65,000 A ¹	#6 300	#6 3 00	11	Both	No

Convertible Mains – Factory-Installed QDL Main Circuit Breaker – Copper Bus

100	QO327M100 ³	QOC30UF/S	A, D	22,000 A	#4 2 / 0	#4 2 / 0	9	Both	No
125	QO330MQ125 ^{2 4}	QOC342MQF/S	A, D	100,000 A ^{5 6}	#4 300	#4 3 00	12	H	No
150	QO330MQ150 ^{2 4}	QOC342MQF/S	A, D	100,000 A ^{5 6}	#4 300	#4 3 00	12	H	No
	QO342MQ150 ^{2 4}	QOC342MQF/S	A, D	100,000 A ^{5 6}	#4 300	#4 3 00	12	H	
200	QO330MQ200 ^{2 4}	QOC342MQF/S	A, D	100,000 A ^{5 6}	#4 300	#4 3 00	12	H	No
	QO342MQ200 ^{2 4}	QOC342MQF/S	A, D	100,000 A ^{5 6}	#4 300	#4 3 00	12	H	
225	QO342MQ225 ^{2 4}	QOC342MQF/S	A, D	100,000 A ^{5 6}	#4 300	#4 3 00	12	H	No

¹ Short circuit current rating depends on lowest AIR rating of branch circuit breaker installed.

² Certified to IEC 60439-1 for use on 415Y/240 Vac 3-phase 4-wire, 3,000 SCCR when QODX ... branch circuit breakers are used and 10,000 SCCR when QO...VS branch circuit breakers are used. CE marked.

³ Includes factory-installed back-fed QO3100VH main circuit breaker.

⁴ Mains positioning from top to bottom feed: first rotate the main circuit breaker 180 degrees, then rotate the complete load center 180 degrees.

⁵ 100,000 A rms at 208 Vac symmetrical maximum when type QJL main circuit breaker from Square D® with 100,000 A rms minimum interrupting rating is installed and when all installed QO® and Q1 branch circuit breakers have 10,000 A rms symmetrical minimum interrupting rating.

⁶ 25,000 A rms symmetrical maximum when supplied by integral type QDL main circuit breaker from Square D® with 25,000 A rms minimum interrupting rating and when all installed QO® and Q1 branch circuit breakers have 10,000 A rms symmetrical minimum interrupting rating.

A UL Listed as suitable for use as service equipment (neutral bonded at the time of installation) with factory-installed service disconnect.

B UL Listed as suitable for use as service equipment (neutral bonded at the time of installation) with field-installed service disconnect.

C UL Listed as suitable for use as service equipment (neutral bonded at the time of installation) when not more than six service disconnecting means are provided and when not used as a lighting and appliance branch circuit panelboard. See NEC Section 384-14.

D UL Listed as suitable for use as service equipment (neutral bonded at the time of installation) with field-installed main lugs, when not more than six service disconnecting means are provided and when not used as a lighting and appliance branch circuit panelboard. See NEC Article for Lighting and Appliance Branch Circuit Panelboard.

QO[®] and Homeline[®] Load Centers and Enclosures Technical Information

Mains Rating in Amps	Load Center Catalog Number	Load Center Cover Catalog Number	UL Listed Service Equipment (See Notes)	Maximum UL Short Circuit Rating ¹	Main Wire Size AWG/kcmil Al/Cu	Enclosure No. (Pages 26 and 27)	Top or Bottom Mains Position	UL Listed for Corner Grounded Delta Systems
----------------------	----------------------------	----------------------------------	---	--	--------------------------------	---------------------------------	------------------------------	---

Load Center with Cover – 1-Phase, 3-Wire, 120/240 Vac – UL Listed; Complete QO[®] Load Center – Box, Interior and Combination Cover (in one package)

Convertible Mains – Factory-Installed Main Lugs; QOM1 Main Frame Size – Convertible to Main Circuit Breaker – Copper Bus

125	QO112L125GC	Included	B, C	65,000 A ^{2 3}	#4 2 /0	6	Both	Yes
	QO11224L125GC	Included	B, C	65,000 A ^{2 3}	#4 2 /0	6	Both	Yes
	QO120L125GC	Included	B, C	65,000 A ^{2 3}	#4 2 /0	7	Both	Yes

Convertible Mains – Factory-Installed Main Lugs; QOM2 Main Frame Size – Convertible to Main Circuit Breaker – Copper Bus

150	QO130L150TC	Included	B, C	65,000 A ^{2 3}	#4 2 50	9	Both	Yes
200	QO13040L200GC	Included	B, C	65,000 A ^{2 3}	#4 2 50	9	Both	Yes

**Convertible Mains – Factory-Installed Main Circuit Breaker – 22,000 RMS Symmetrical Amperes Short Circuit Current Rating
QOM1 Main Frame Size – Convertible to Main Lugs – Copper Bus**

100	QO112M100C	Included	A, D	22,000 A ²	#4-1/0	5	Both	Yes
	QO11220M100C	Included	A, D	22,000 A ²	#4-1/0	5	Both	Yes
	QO116M100C	Included	A, D	22,000 A ²	#4-1/0	6	Both	Yes
	QO120M100C	Included	A, D	22,000 A ²	#4-1/0	6	Both	Yes

**Convertible Mains – Factory-Installed Main Circuit Breaker – 22,000 RMS Sym. Amperes Short Circuit Current Rating
QOM2 Main Frame Size – Convertible to Main Lugs – Copper Bus**

150	QO12030M150C	Included	A, D	22,000 A ²	#4 2 50	9	Both	No
	QO130M150C	Included	A, D	22,000 A ²	#4 2 50	9	Both	No
200 A	QO12040M200C	Included	A, D	22,000 A ²	#4 2 50	9	Both	No
	QO130M200C	Included	A, D	22,000 A ²	#4 2 50	9	Both	No
	QO13040M200C	Included	A, D	22,000 A ²	#4 2 50	9	Both	No
	QO140M200C	Included	A, D	22,000 A ²	#4 2 50	10	Both	No

Non-Metallic 1-Phase, 3-Wire, 120/240 Vac – Main Lugs Only

60	QO24L60NRNM	Included	B, C	10,000 A	#14 4	1NM	Bottom	No
----	-------------	----------	------	----------	-------	-----	--------	----

Riser , 1-Phase, 3-Wire, 120/240 Vac – Factory-Installed Main Lugs – Offset Interior Wide Gutter QOM1/QOM2 ⁴ Main Frame Size – Convertible to Main Circuit Breaker – Copper Bus ³

125	QO11224L125WG	QOC20UFWG	B, C	65,000 A ²	#4 2 /0	14	Both	Yes
	QO12030L125WG		B	65,000 A ²	#4 2 /0	14	Both	
200	QO13040L200WG	QOC30UFW	B, C	65,000 A	#4 2 50	23	Both	Yes

Generator Panel, 1-Phase, 3-Wire, 120/240 Vac – Factory-Installed Main Circuit Breakers with Mechanical Interlock

30	QO48M30DSGP	Included	No	10,000 A	#14 8	4	Bottom	No
60	QO48M60DSGP		A	10,000 A	#8 2	4	Bottom	

Generator Panel - Use with Automatic Transfer Switch, 1-Phase, 3-Wire, 120 / 240 Vac, Factory- / Field-Installed Main Circuit Breaker – 22,000 RMS Sym. Amperes Short Circuit Current Rating ⁵

150	QO13842MX150	QOC38MXUF	A	22,000 A	#4-250	12	Both	No
200	QO13842MX200		A	22,000 A	#4-250	12	Both	No
225	QO13842MX225		A	22,000 A	#4-250	12	Both	No
	QO13842UX225		B	22,000 A	#4-250	12	Both	No
150	QO11428MX150FTRB ⁶	Included	A	22,000 A	#4-250	7R	Both	No
200	QO11428MX200FTRB ⁶	Included	A	22,000 A	#4-250	7R	Both	No
	QO11428UX200FTRB ⁶	Included	B	22,000 A	#4-250	7R	Both	No

¹ Short circuit current rating depends on lowest AIR rating of main or branch circuit breaker installed.

² 22,000 A rms symmetrical maximum when supplied by integral type QOM-VH main circuit breaker from Square D[®] with 22,000 A rms symmetrical minimum interrupting rating and when all installed QO[®] branch circuit breakers have 10,000 A rms symmetrical minimum interrupting rating.

³ UL Listed for 5000 A rms symmetrical short circuit rating when used in 3-phase, 240 Vac, corner grounded Delta systems, when used as main lugs load center **only**. Use QO-H 240 Vac circuit breakers only.

⁴ QOM2 Load Center is ONLY convertible to main circuit breaker when used with QOC cover.

⁵ One main circuit breaker is included with panel. Alternate source main circuit breaker (QO 125 A max.) must be ordered separately. Automatic transfer switch and generator kit for secondary power sources are ordered through a Kohler[®] authorized dealer or contractor.

⁶ Side-hinge door device allow 1.25 in. (32mm) on the left side for the door to open.

A UL Listed as suitable for use as service equipment (neutral bonded at the time of installation) with factory-installed service disconnect.

B UL Listed as suitable for use as service equipment (neutral bonded at the time of installation) with field-installed service disconnect.

C UL Listed as suitable for use as service equipment (neutral bonded at the time of installation) when not more than six service disconnecting means are provided and when not used as a lighting and appliance branch circuit panelboard. See NEC Article for Lighting and Appliance Branch Circuit Panelboard.

D UL Listed as suitable for use as service equipment (neutral bonded at the time of installation) with field-installed main lugs and not more than six service disconnecting means are provided and when not used as a lighting and appliance branch circuit panelboard. See NEC Article for Lighting and Appliance Branch Circuit Panelboard.

QO® Circuit Breaker Load Centers—Class 1130

Indoor Dimensions							Indoor Dimensions						
Box No.	W		H		D		Box No.	W		H		D	
	in.	mm	in.	mm	in.	mm		in.	mm	in.	mm	in.	mm
1	3.81	97	6.72	171	3.00	76	13	5.88	149	13.12	333	3.38	86
2	4.81	122	9.30	236	3.19	81	14	14.25	362	20.92	531	3.75	95
3	4.81	122	9.30	236	3.19	81	15	20.00	508	50.00	1270	5.75	146
4	8.88	226	12.57	319	3.80	97	16	20.00	508	68.00	1727	5.75	146
5	14.25	362	14.92	379	3.75	95	17	20.00	508	53.00	1346	5.75	146
6	14.25	362	17.92	455	3.75	95	18	5.88	149	16.12	409	3.38	86
7	14.25	362	20.92	531	3.75	95	19	7.56	192	23.12	587	4.25	108
8	14.25	362	26.04	661	3.75	95	20	9.62	244	26.12	663	4.75	121
9	14.25	362	29.86	758	3.75	95	21	8.88	226	14.80	376	3.80	97
10	14.25	362	33.78	858	3.75	95	22	8.55	217	23.92	608	3.95	100
11	14.25	362	37.98	965	3.75	95	23	14.25	362	29.86	758	3.75	95
12	14.25	362	39.37	1000	3.75	95							

Knockouts									
Symbol	A	B	C	D	E	F	G	H	I
Conduit Size	0.50 in. 13 mm	0.75 in. 19 mm	1.00 in. 25 mm	1.25 in. 32 mm	1.50 in. 38 mm	2.00 in. 51 mm	2.50 in. 64 mm	3.00 in. 76 mm	3.50 in. 89 mm

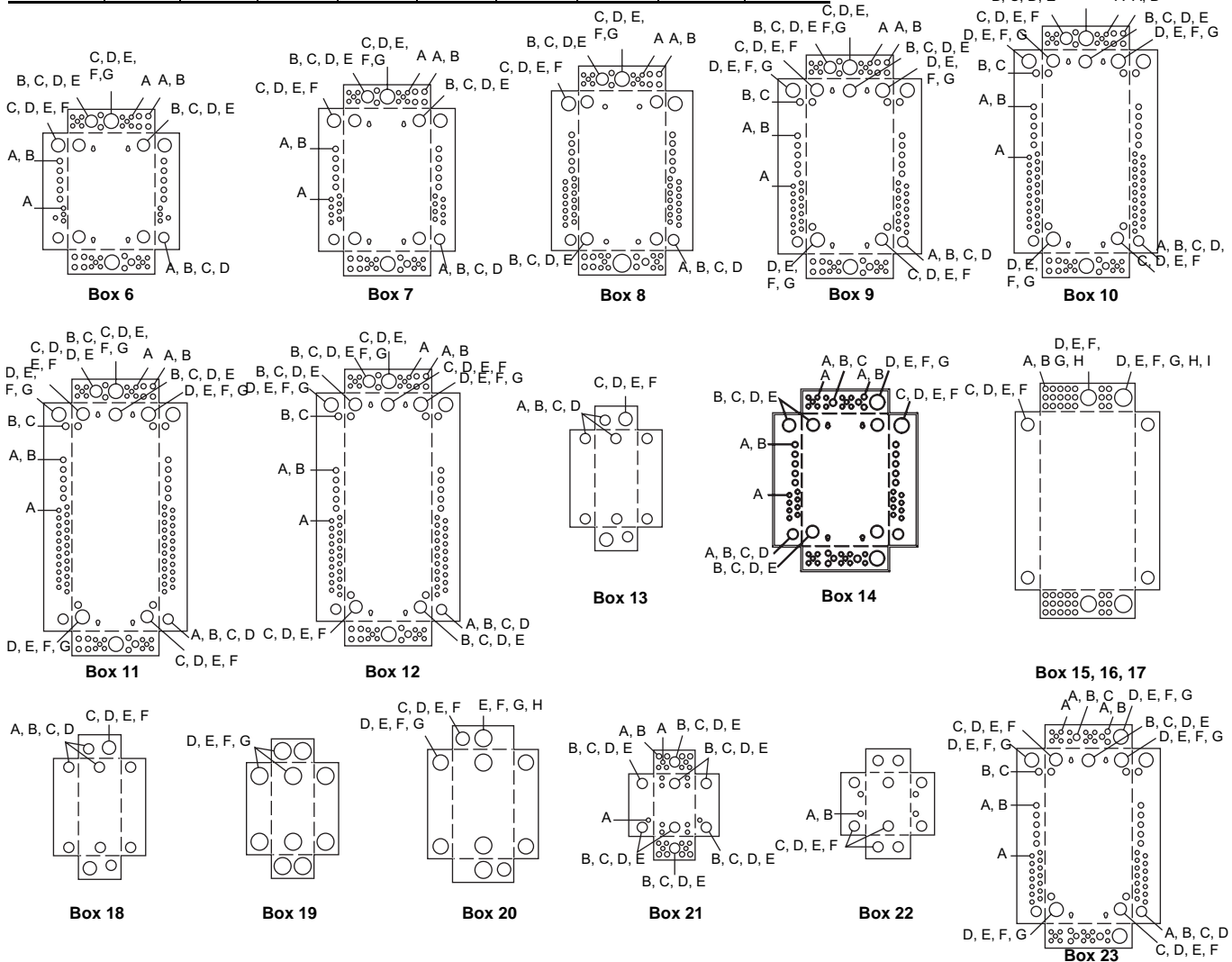
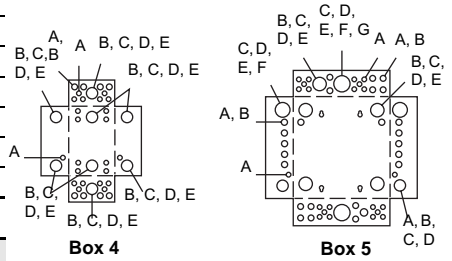
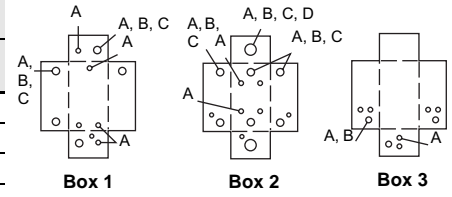

QO® Circuit Breaker Load Centers—Class 1130

QO Single-Phase Labels

QO SINGLE-PHASE LABELS

The labels below represent typical labels. Information may not be applicable or may change without notice. See the actual label in the load center for the latest information.

QO Single-Phase Box Label Sample

<p>Number of circuits maximum. Enclosure catalog number. Catalog number of covers; flush or surface. See panelboard interior for the catalog number. Voltage ratings. Amperage rating.</p>	<p>Wire range for lug torque data table.</p>	<p>Short circuit ratings. Short circuit ratings and additional of replacement circuit breakers.</p>	<p>UL Listing.</p>																																																																																														
<p>QO® LOAD CENTER See Panelboard interior for Catalog No. Box Cat. No. / Caja No. de Catalogo: BX18C Use Cover Cat. No. / Utilice la Cubierta No. de Catalogo: QOC16US or/or QOC16UF Mains 125A max. Lina principal de 125A maximo. See main or service disconnect rating if installed. 240 V ~ Max. 1Ø, 50 / 60 Hz. 24 circuit max. / 24 circuitos maximo. Type 1 Enclosure Gabinete Tipo 1 For installation, repairs or alterations, Call an electrical contractor or electrician.</p>	<p>LUG TORQUE DATA See circuit breakers and field installed units for wire binding screw torque</p> <table border="1" style="width:100%; border-collapse: collapse;"> <thead> <tr> <th>Line Neutral Lug</th> <th>Wire Range (AWG/kcmil)</th> <th>Torque (in./lbs.)</th> </tr> </thead> <tbody> <tr> <td>Line Neutral Lug</td> <td>4 - 2/0 CU/AL</td> <td>50</td> </tr> <tr> <td>Main Lug</td> <td>6 - 2/0 CU/AL</td> <td>50</td> </tr> <tr> <td>Alternate Main Breaker</td> <td>See Main Breaker</td> <td>See Main Breaker</td> </tr> </tbody> </table> <p>Branch Neutral and Equipment Ground Bar</p> <table border="1" style="width:100%; border-collapse: collapse;"> <thead> <tr> <th rowspan="2">Wire Range (AWG)</th> <th colspan="2">Torque (in./lbs.)</th> <th rowspan="2">Bar with 1 screw size</th> </tr> <tr> <th>Bar with 2 screw sizes</th> <th>Small</th> </tr> </thead> <tbody> <tr> <td>1/0 - 3 CU / AL</td> <td>Large 50</td> <td>Small</td> <td>35</td> </tr> <tr> <td>4 CU / AL</td> <td>Large 45</td> <td>Small 25</td> <td>35</td> </tr> <tr> <td>6 CU / AL</td> <td>Large 45</td> <td>Small 25</td> <td>35</td> </tr> <tr> <td>8 CU / AL</td> <td>Large 40</td> <td>Small 10</td> <td>25</td> </tr> <tr> <td>10-14 CU, 10-12 AL</td> <td>Large 35</td> <td>Small 10</td> <td>20</td> </tr> </tbody> </table> <p>Equipment Ground Combinations</p> <table border="1" style="width:100%; border-collapse: collapse;"> <thead> <tr> <th></th> <th>35</th> <th>10</th> <th>25</th> </tr> </thead> <tbody> <tr> <td>Two 14 or 12 CU, Two 12 AL</td> <td>35</td> <td>10</td> <td>25</td> </tr> <tr> <td>Two 10 AL</td> <td>35</td> <td>10</td> <td>25</td> </tr> </tbody> </table>	Line Neutral Lug	Wire Range (AWG/kcmil)	Torque (in./lbs.)	Line Neutral Lug	4 - 2/0 CU/AL	50	Main Lug	6 - 2/0 CU/AL	50	Alternate Main Breaker	See Main Breaker	See Main Breaker	Wire Range (AWG)	Torque (in./lbs.)		Bar with 1 screw size	Bar with 2 screw sizes	Small	1/0 - 3 CU / AL	Large 50	Small	35	4 CU / AL	Large 45	Small 25	35	6 CU / AL	Large 45	Small 25	35	8 CU / AL	Large 40	Small 10	25	10-14 CU, 10-12 AL	Large 35	Small 10	20		35	10	25	Two 14 or 12 CU, Two 12 AL	35	10	25	Two 10 AL	35	10	25	<p>SHORT CIRCUIT RATING RMS Symmetrical Amperes at 120 / 240 V ~ Maximum</p> <table border="1" style="width:100%; border-collapse: collapse;"> <thead> <tr> <th>Panel Rating</th> <th>Remote Main</th> <th>Integral Main</th> <th>Branch (min.) / Cat. prefix</th> </tr> </thead> <tbody> <tr> <td>*65,000</td> <td>---</td> <td>Lugs</td> <td>65,000 / QH</td> </tr> <tr> <td>*42,000</td> <td>---</td> <td>Lugs</td> <td>42,000 / QOH</td> </tr> <tr> <td>*22,000</td> <td>---</td> <td>Lugs</td> <td>22,000 / QO.VH</td> </tr> <tr> <td>*10,000</td> <td>---</td> <td>Lugs</td> <td>10,000 / QO, QOT & Q1</td> </tr> <tr> <td>*5,000</td> <td>---</td> <td>Lugs</td> <td>5,000 / QO...H (2 pole)</td> </tr> <tr> <td>100,000</td> <td>--100-200A 300V T Fuse</td> <td>Lugs</td> <td>10,000 / QO & QOT</td> </tr> <tr> <td>42,000</td> <td>QOH</td> <td>Lugs</td> <td>10,000 / QO & QOT</td> </tr> <tr> <td>22,000</td> <td>Q2...H, KD, QO...VH</td> <td>Lugs</td> <td>10,000 / QO & QOT</td> </tr> <tr> <td>65,000</td> <td>KG</td> <td>Lugs</td> <td>10,000 / QO & QOT</td> </tr> <tr> <td>22,000</td> <td>---</td> <td>QOM...VH</td> <td>10,000 / QO, QOT & Q1</td> </tr> </tbody> </table> <p>** 240 v ~ 3Ph. 3W. Grounded "B" phase requires 240 V ~ branch breakers. * The rating is equal to the lowest interrupting rating of any circuit breaker installed. Refer to branch breaker for individual ratings. Additional or replacement branch circuit breakers, main breaker, or service disconnect MUST have an interrupting rating equal to or greater than that of the circuit breaker with the lowest interrupting rating presently installed. See panelboard interior for breaker types.</p>	Panel Rating	Remote Main	Integral Main	Branch (min.) / Cat. prefix	*65,000	---	Lugs	65,000 / QH	*42,000	---	Lugs	42,000 / QOH	*22,000	---	Lugs	22,000 / QO.VH	*10,000	---	Lugs	10,000 / QO, QOT & Q1	*5,000	---	Lugs	5,000 / QO...H (2 pole)	100,000	--100-200A 300V T Fuse	Lugs	10,000 / QO & QOT	42,000	QOH	Lugs	10,000 / QO & QOT	22,000	Q2...H, KD, QO...VH	Lugs	10,000 / QO & QOT	65,000	KG	Lugs	10,000 / QO & QOT	22,000	---	QOM...VH	10,000 / QO, QOT & Q1	<p>UL Underwriter's Laboratories, Inc.® LISTED Electric Cabinet Box Issue No. V-2813</p> <p>Install loose label with Spanish translation on back of cover. Adhiera la etiqueta suelta con las traducciones en español en la parte posterior del frente. Por favor lea la información antes de instalar.</p> <p>SQUARE D COMPANY® 001021 15 40265-381-03</p>
Line Neutral Lug	Wire Range (AWG/kcmil)	Torque (in./lbs.)																																																																																															
Line Neutral Lug	4 - 2/0 CU/AL	50																																																																																															
Main Lug	6 - 2/0 CU/AL	50																																																																																															
Alternate Main Breaker	See Main Breaker	See Main Breaker																																																																																															
Wire Range (AWG)	Torque (in./lbs.)		Bar with 1 screw size																																																																																														
	Bar with 2 screw sizes	Small																																																																																															
1/0 - 3 CU / AL	Large 50	Small	35																																																																																														
4 CU / AL	Large 45	Small 25	35																																																																																														
6 CU / AL	Large 45	Small 25	35																																																																																														
8 CU / AL	Large 40	Small 10	25																																																																																														
10-14 CU, 10-12 AL	Large 35	Small 10	20																																																																																														
	35	10	25																																																																																														
Two 14 or 12 CU, Two 12 AL	35	10	25																																																																																														
Two 10 AL	35	10	25																																																																																														
Panel Rating	Remote Main	Integral Main	Branch (min.) / Cat. prefix																																																																																														
*65,000	---	Lugs	65,000 / QH																																																																																														
*42,000	---	Lugs	42,000 / QOH																																																																																														
*22,000	---	Lugs	22,000 / QO.VH																																																																																														
*10,000	---	Lugs	10,000 / QO, QOT & Q1																																																																																														
*5,000	---	Lugs	5,000 / QO...H (2 pole)																																																																																														
100,000	--100-200A 300V T Fuse	Lugs	10,000 / QO & QOT																																																																																														
42,000	QOH	Lugs	10,000 / QO & QOT																																																																																														
22,000	Q2...H, KD, QO...VH	Lugs	10,000 / QO & QOT																																																																																														
65,000	KG	Lugs	10,000 / QO & QOT																																																																																														
22,000	---	QOM...VH	10,000 / QO, QOT & Q1																																																																																														

QO Single-Phase Wiring Diagram Sample

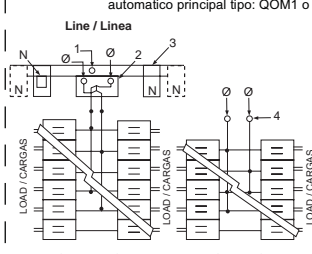
<p>Service Equipment marking. Use of unused neutral branch terminal for equipment grounding, service equipment application only.</p>	<p>Installation of back-fed main circuit breaker and required kit. Alternate wiring diagram for main circuit breaker or main lug.</p>	<p>Type of circuit breakers from Square D that may be used in this panelboard.</p>	<p>Load center accessories. Neutral lug for 1/0 AWG or larger wire.</p>
<p>Suitable for use with 75°C Copper or Aluminum main conductors. See branch breakers for branch wire ratings.</p> <p>* Suitable for use as service equipment when service disconnect (main breaker) is installed. * Suitable for use as service equipment when not more than six main disconnecting means are provided and when not used as a lighting and appliance branch circuit panelboard. See Article 384-14 of the NEC. * When used as service equipment, all unused neutral terminals may be used for terminating equipment ground wires.</p>	<p>1. Box bonding when required. / Conexion a la caja cuando fuese necesario. 2. Main breaker type: QOM1 or QOM1A. / Interruptor automatico principal tipo: QOM1 o QOM1A.</p>  <p>3. Service ground when required. / Tierra de acometida cuando fuese necesario</p> <p>1. Main lugs kit no: QOL125. / No. de accesorio de las zapatas principales: QOL125.</p>	<p>Two single poles. One plug on space or may use one single pole. One two pole requires two spaces. Torque Note: When main breaker or main lug connector mounting nuts are loosened or removed, retighten to 75 lbs./in. torque.</p> <p>Equipment Grounding Terminals</p>	<p>Load Center Accessories - Kits</p> <ul style="list-style-type: none"> PK4MB2LA Back-fed Main Cir. Brkr. Retaining QO2175SB Plug-On Surge Arrestor * SDSA1175 1 Phase Surge Arrestor QOSAMK SDSA1175 Mounting Bracket QOL2125 1 Phase Plug-on Subfeed Lugs * PK9--27GTA(L) Equipment Ground Bar PKG7AB Equipment Ground Bar Insulator LK70AN 70A Max. Neutral Lug LK100AN 125A Max. Neutral Lug QOL125 Main Lugs PK6FL Indoor Cover Lock <p>* May plug on two adjacent spaces. Torque Note: When interior mounting screw is loosened or removed, retighten to 35 lbs./in.</p> <p>SQUARE D COMPANY® Made in U.S.A. 15 40265-668-02</p>

QO[®] and Homeline[®] Load Centers and Enclosures QO Three-Phase Label Samples



QO THREE-PHASE LABEL SAMPLES

The labels below represent typical labels. Information may not be applicable or may change without notice. See the actual label in the load center for the latest information.

QO Three-Phase Box Label Sample

<p>Number of circuits maximum. Enclosure catalog number. Catalog number of covers; flush or surface. See panelboard interior for the catalog number. Voltage ratings. Amperage rating.</p>	<p>Wire range for lug torque data table.</p>	<p>Short circuit ratings. Short circuit ratings and additional of replacement circuit breakers.</p>	<p>UL Listing.</p>																																																																																																		
<p>QO[®] LOAD CENTER See Panelboard interior for Catalog No. Box Cat. No. / Caja No. de Catalogo: BX338C Use Cover Cat. No. / Utilice la Cubierta No. de Catalogo: QOC42US or/or QOC42UF Mains 225A / Lina principal de 225A maximo. See main or service disconnect rating if installed. 240 V ~ Max. 3Ø, 50 / 60 Hz. 42 circuit max. / 42 circuitos maximo. Type 1 Enclosure Gabinete Tipo 1 240V, 3PH, 3W: For this system neutral is not used and only breakers rated 240V are to be used. 240V, 3PH, 4W: When wired for delta system, phase "B" must be 208V to neutral. Breaker poles connected to phase "B" must be rated 240V. 1PH: Single pole breakers can not be connected to phase B.</p>	<p>LUG TORQUE DATA See circuit breakers and field installed units for wire binding screw torque</p> <table border="1" style="width:100%; border-collapse: collapse;"> <thead> <tr> <th>Line</th> <th>Wire Range (AWG/kcmil)</th> <th>Torque (in/lbs.)</th> </tr> </thead> <tbody> <tr> <td>Line Neutral</td> <td>4 - 300 CU/AL</td> <td>250</td> </tr> <tr> <td>Main Lug</td> <td>4 - 300 CU/AL</td> <td>250</td> </tr> <tr> <td>Alternate Main Breaker</td> <td>See Main Breaker</td> <td>See Main Breaker</td> </tr> </tbody> </table> <p>Branch Neutral and Equipment Ground Bar</p> <table border="1" style="width:100%; border-collapse: collapse;"> <thead> <tr> <th rowspan="2">Wire Range (AWG)</th> <th colspan="2">Torque (in./lbs.)</th> <th rowspan="2">Bar with 1 screw size</th> </tr> <tr> <th>Bar with 2 screw sizes</th> <th>Small</th> </tr> </thead> <tbody> <tr> <td>1/0 - 3 CU / AL</td> <td>Large 50</td> <td>Small</td> <td>20</td> </tr> <tr> <td>4 CU / AL</td> <td>Large 45</td> <td>Small</td> <td>35</td> </tr> <tr> <td>6 CU / AL</td> <td>Large 45</td> <td>Small 25</td> <td>35</td> </tr> <tr> <td>8 CU / AL</td> <td>Large 40</td> <td>Small 10</td> <td>25</td> </tr> <tr> <td>10-14 CU, 10-12 AL</td> <td>Large 35</td> <td>Small 10</td> <td>20</td> </tr> </tbody> </table> <p>Equipment Ground Combinations</p> <table border="1" style="width:100%; border-collapse: collapse;"> <thead> <tr> <th>Two 14 or 12 CU, Two 12 AL</th> <th>35</th> <th>10</th> <th>25</th> </tr> </thead> <tbody> <tr> <td>Two 10 AL</td> <td>35</td> <td></td> <td>25</td> </tr> </tbody> </table>	Line	Wire Range (AWG/kcmil)	Torque (in/lbs.)	Line Neutral	4 - 300 CU/AL	250	Main Lug	4 - 300 CU/AL	250	Alternate Main Breaker	See Main Breaker	See Main Breaker	Wire Range (AWG)	Torque (in./lbs.)		Bar with 1 screw size	Bar with 2 screw sizes	Small	1/0 - 3 CU / AL	Large 50	Small	20	4 CU / AL	Large 45	Small	35	6 CU / AL	Large 45	Small 25	35	8 CU / AL	Large 40	Small 10	25	10-14 CU, 10-12 AL	Large 35	Small 10	20	Two 14 or 12 CU, Two 12 AL	35	10	25	Two 10 AL	35		25	<p>SHORT CIRCUIT RATING RMS Symmetrical Amperes at 120 / 240 V ~ Maximum</p> <table border="1" style="width:100%; border-collapse: collapse;"> <thead> <tr> <th>Panel Rating</th> <th>Remote Main</th> <th>Integral Main</th> <th>Branch (min./ Cat. prefix)</th> </tr> </thead> <tbody> <tr> <td>*65,000</td> <td>----</td> <td>Lugs</td> <td>65,000 / OH</td> </tr> <tr> <td>*42,000</td> <td>----</td> <td>Lugs</td> <td>42,000 / OOH</td> </tr> <tr> <td>*22,000</td> <td>----</td> <td>Lugs</td> <td>22,000 / OO.VH</td> </tr> <tr> <td>*10,000</td> <td>----</td> <td>Lugs</td> <td>10,000 / OO&O1.OO..H</td> </tr> <tr> <td>*5,000</td> <td>----</td> <td>Lugs</td> <td>5,000 / OO..H(2 POLE)</td> </tr> <tr> <td>100,000</td> <td>100-200A 300V T Fuse</td> <td>Lugs</td> <td>10,000 / OO</td> </tr> <tr> <td>22,000</td> <td>KD, OO..VH</td> <td>Lugs</td> <td>10,000 / OO</td> </tr> <tr> <td>22,000</td> <td>Q2..H</td> <td>Lugs</td> <td>10,000 / OO (10A-60A)</td> </tr> <tr> <td>65,000</td> <td>KG</td> <td>Lugs</td> <td>10,000 / OO</td> </tr> <tr> <td>65,000</td> <td>----</td> <td>KG</td> <td>10,000 QO&O1</td> </tr> <tr> <td>22,000</td> <td>----</td> <td>KD</td> <td>10,000 QO&O1</td> </tr> <tr> <td>22,000</td> <td>----</td> <td>OO..VH</td> <td>10,000 / OO</td> </tr> </tbody> </table> <p>** 240 v ~ 3Ph, 3W. Grounded "B" phase requires 240 V ~ branch breakers. * The rating is equal to the lowest interrupting rating of any circuit breaker installed. Refer to branch breaker for individual ratings. Additional or replacement branch circuit breakers, main breaker, or service disconnect MUST have an interrupting rating equal to or greater than that of the circuit breaker with the lowest interrupting rating presently installed. See panelboard interior for breaker types.</p>	Panel Rating	Remote Main	Integral Main	Branch (min./ Cat. prefix)	*65,000	----	Lugs	65,000 / OH	*42,000	----	Lugs	42,000 / OOH	*22,000	----	Lugs	22,000 / OO.VH	*10,000	----	Lugs	10,000 / OO&O1.OO..H	*5,000	----	Lugs	5,000 / OO..H(2 POLE)	100,000	100-200A 300V T Fuse	Lugs	10,000 / OO	22,000	KD, OO..VH	Lugs	10,000 / OO	22,000	Q2..H	Lugs	10,000 / OO (10A-60A)	65,000	KG	Lugs	10,000 / OO	65,000	----	KG	10,000 QO&O1	22,000	----	KD	10,000 QO&O1	22,000	----	OO..VH	10,000 / OO	<p>UL Underwriter's Laboratories, Inc.[®] LISTED Electric Cabinet Box Issue No. V-2813</p> <p>For installation, repairs or alterations, Call an electrical contractor or electrician. Install loose label with Spanish translation on back of cover. Adhiera la etiqueta sauelat con la traduccion en Español en la parte posterior de la cubierta. Please read information before installing. Por favor lea la información antes de instalar.</p> <p>SQUARE D COMPANY[®] 001021 15 40265-381-03</p>
Line	Wire Range (AWG/kcmil)	Torque (in/lbs.)																																																																																																			
Line Neutral	4 - 300 CU/AL	250																																																																																																			
Main Lug	4 - 300 CU/AL	250																																																																																																			
Alternate Main Breaker	See Main Breaker	See Main Breaker																																																																																																			
Wire Range (AWG)	Torque (in./lbs.)		Bar with 1 screw size																																																																																																		
	Bar with 2 screw sizes	Small																																																																																																			
1/0 - 3 CU / AL	Large 50	Small	20																																																																																																		
4 CU / AL	Large 45	Small	35																																																																																																		
6 CU / AL	Large 45	Small 25	35																																																																																																		
8 CU / AL	Large 40	Small 10	25																																																																																																		
10-14 CU, 10-12 AL	Large 35	Small 10	20																																																																																																		
Two 14 or 12 CU, Two 12 AL	35	10	25																																																																																																		
Two 10 AL	35		25																																																																																																		
Panel Rating	Remote Main	Integral Main	Branch (min./ Cat. prefix)																																																																																																		
*65,000	----	Lugs	65,000 / OH																																																																																																		
*42,000	----	Lugs	42,000 / OOH																																																																																																		
*22,000	----	Lugs	22,000 / OO.VH																																																																																																		
*10,000	----	Lugs	10,000 / OO&O1.OO..H																																																																																																		
*5,000	----	Lugs	5,000 / OO..H(2 POLE)																																																																																																		
100,000	100-200A 300V T Fuse	Lugs	10,000 / OO																																																																																																		
22,000	KD, OO..VH	Lugs	10,000 / OO																																																																																																		
22,000	Q2..H	Lugs	10,000 / OO (10A-60A)																																																																																																		
65,000	KG	Lugs	10,000 / OO																																																																																																		
65,000	----	KG	10,000 QO&O1																																																																																																		
22,000	----	KD	10,000 QO&O1																																																																																																		
22,000	----	OO..VH	10,000 / OO																																																																																																		

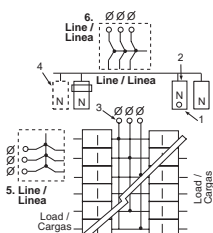
QO Three-Phase Wiring Diagram Sample

<p>Service Equipment marking. Use of unused neutral branch terminal for equipment grounding, service equipment application only.</p>	<p>Alternate wiring diagram for main circuit breaker or main lug. Installation of back-fed main circuit breaker and required kit.</p>	<p>Type of circuit breakers from Square D that may be used in this panelboard.</p>	<p>Load center accessories. Neutral lug for 1/0 AWG or larger wire.</p>																						
<p>Suitable for use with 75°C Copper or Aluminum main conductors. See branch breakers for branch wire ratings.</p> <p>* Suitable for use as service equipment when service disconnect (main breaker) is installed. * Suitable for use as service equipment when not more than six main disconnecting means are provided and when not used as a lighting and appliance branch circuit panelboard. See Article 384-14 of the NEC. * When used as service equipment, all unused neutral terminals may be used for terminating equipment ground wires.</p>	<p>1. Box bonding when required. / Conexión a la caja cuando fuese necesario. 2. Service ground when required. / Tierra de acometida cuando fuese necesario. 3. Main lugs kit no: QOL3225. / No. de accesorio de las zapatas principales: QOL3225. 4. Lug kit when installed. / Accesorio de la zapata, cuando se instala. 5. Back fed main circuit breaker when installed. / Interruptor automático principal de alimentación posterior, cuando se instala. 6. Integral main circuit breaker when installed. / Interruptor automático integral principal, cuando se instala.</p> 	<p> One single pole. One plug on space. One two pole requires two plug on spaces. One three pole requires three plug on spaces. Torque Note: When main breaker or main lug connector mounting nuts are loosened or removed, retighten to 75 lbs./in. torque.</p> <p> Equipment Grounding Terminals</p>	<p>Load Center Accessories - Kits</p> <table border="0"> <tr> <td>PK3MB</td> <td>Back-fed Main Cir. Brkr. Retaining</td> </tr> <tr> <td>SDSA3650</td> <td>3 Phase Surge Arrestor</td> </tr> <tr> <td>QO60SL</td> <td>1 Phase Plug-on Subfeed Lugs *</td> </tr> <tr> <td>QO2125SL</td> <td>1 Phase Plug-on Subfeed Lugs *</td> </tr> <tr> <td>QO3125SL</td> <td>3 Phase Plug-on Subfeed Lugs +</td> </tr> <tr> <td>PK9-27GTA(L)</td> <td>Equipment Ground Bar</td> </tr> <tr> <td>PKG7AB</td> <td>Equipment Ground Bar Insulator</td> </tr> <tr> <td>LK100AN</td> <td>125A Max. Neutral Lug</td> </tr> <tr> <td>LK150AN</td> <td>150A Max. Neutral Lug</td> </tr> <tr> <td>QOL3225</td> <td>Main Lugs</td> </tr> <tr> <td>PK6FL</td> <td>Indoor Cover Lock</td> </tr> </table> <p>* May plug on two adjacent spaces. + May plug on three adjacent spaces.</p> <p>Torque Note: When interior or main breaker mounting screws are loosened or removed, retighten to 35 lbs./in.</p> <p>SQUARE D COMPANY[®] Made in U.S.A. 15 40265-545-01</p>	PK3MB	Back-fed Main Cir. Brkr. Retaining	SDSA3650	3 Phase Surge Arrestor	QO60SL	1 Phase Plug-on Subfeed Lugs *	QO2125SL	1 Phase Plug-on Subfeed Lugs *	QO3125SL	3 Phase Plug-on Subfeed Lugs +	PK9-27GTA(L)	Equipment Ground Bar	PKG7AB	Equipment Ground Bar Insulator	LK100AN	125A Max. Neutral Lug	LK150AN	150A Max. Neutral Lug	QOL3225	Main Lugs	PK6FL	Indoor Cover Lock
PK3MB	Back-fed Main Cir. Brkr. Retaining																								
SDSA3650	3 Phase Surge Arrestor																								
QO60SL	1 Phase Plug-on Subfeed Lugs *																								
QO2125SL	1 Phase Plug-on Subfeed Lugs *																								
QO3125SL	3 Phase Plug-on Subfeed Lugs +																								
PK9-27GTA(L)	Equipment Ground Bar																								
PKG7AB	Equipment Ground Bar Insulator																								
LK100AN	125A Max. Neutral Lug																								
LK150AN	150A Max. Neutral Lug																								
QOL3225	Main Lugs																								
PK6FL	Indoor Cover Lock																								

QO® Circuit Breaker Load Centers—Class 1130

Wiring Diagrams

WIRING DIAGRAMS

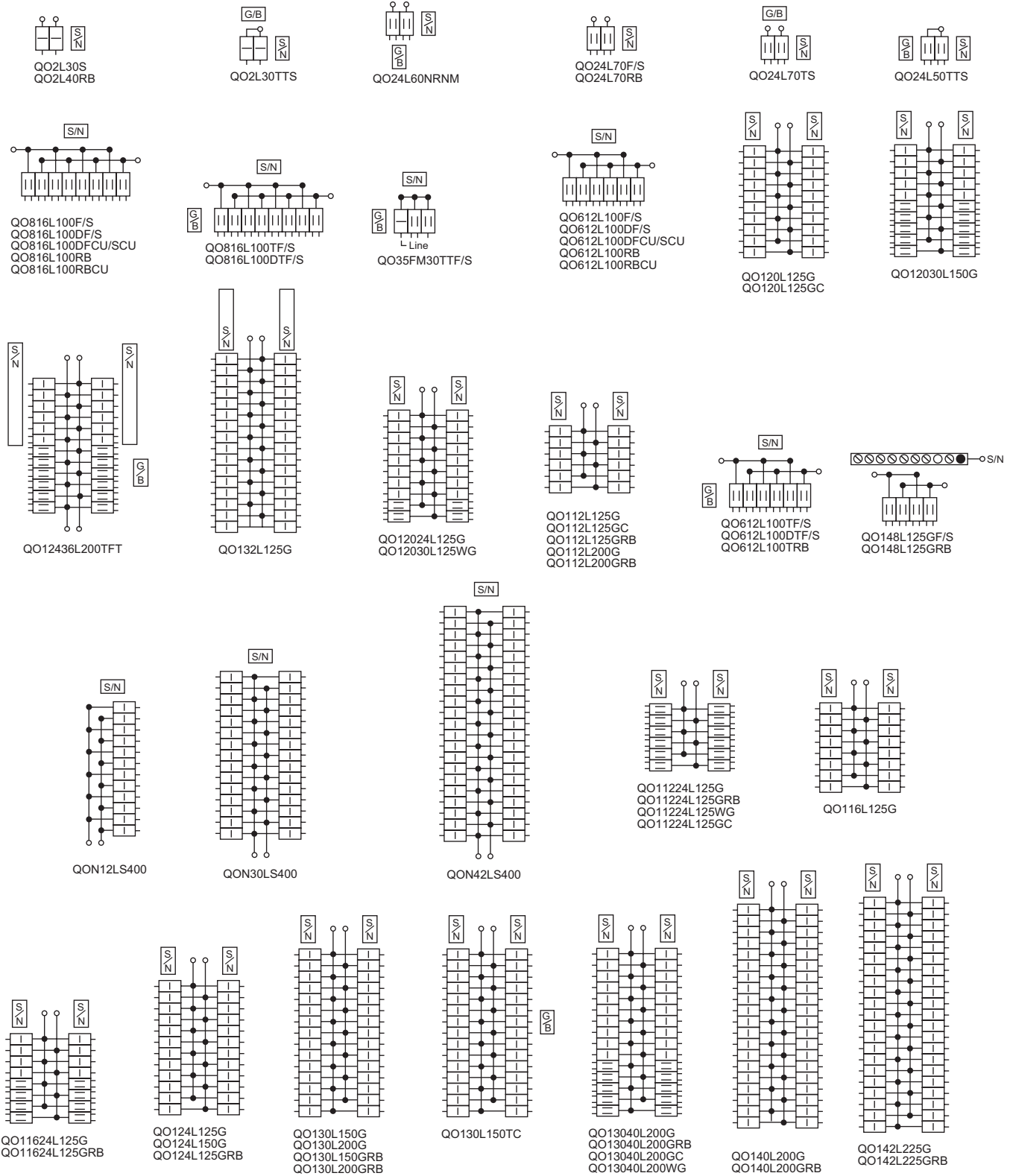

1-Phase, 3-Wire Main Lugs

QO® and Homeline® Load Centers and Enclosures Wiring Diagrams

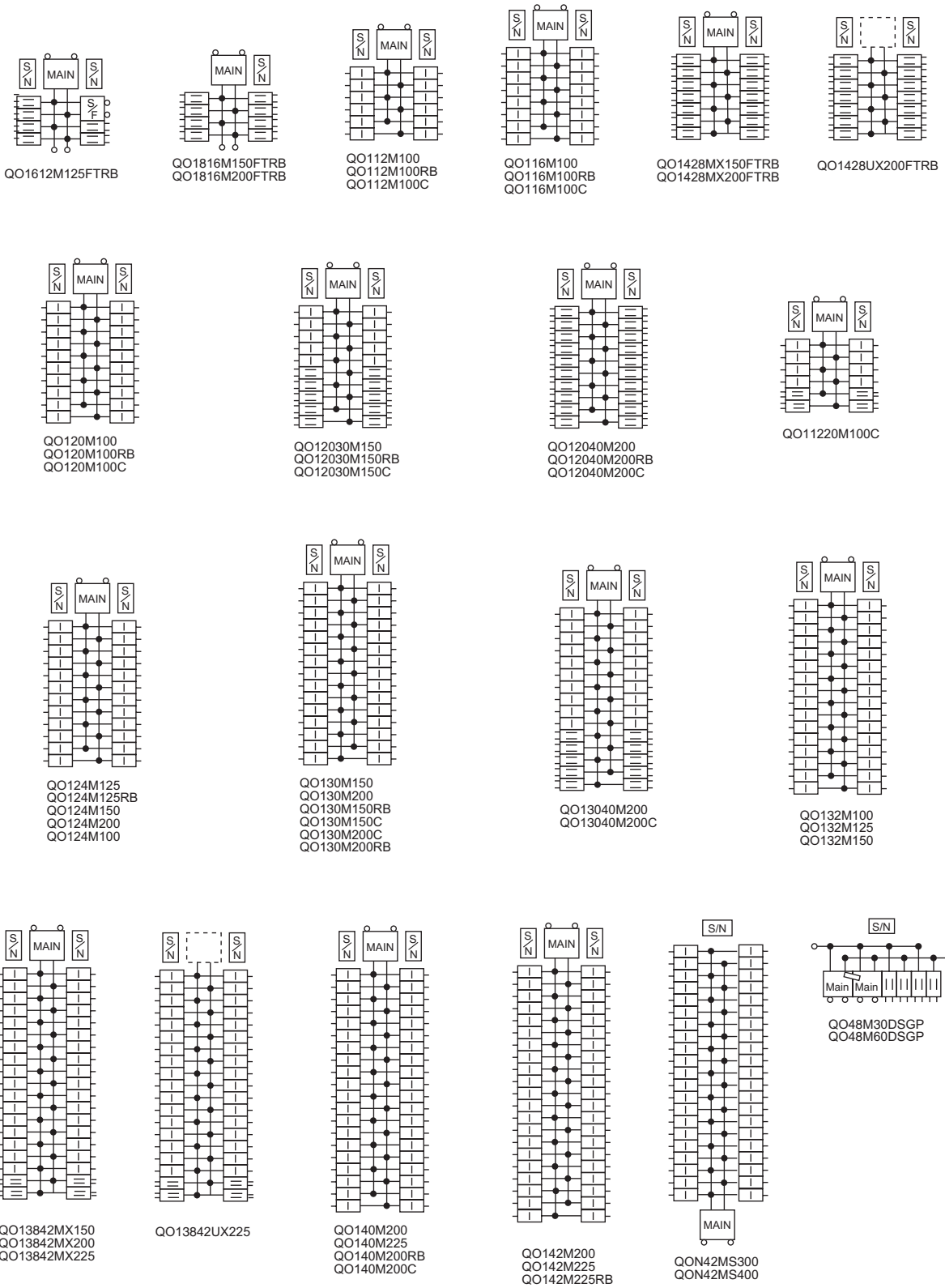

1-Phase, 3-Wire Main Circuit Breakers

QO® Circuit Breaker Load Centers—Class 1130

Wiring Diagrams

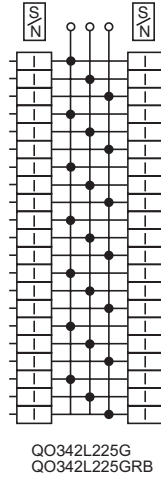
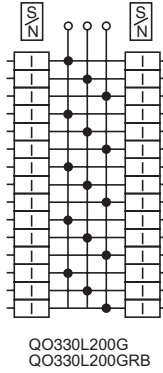
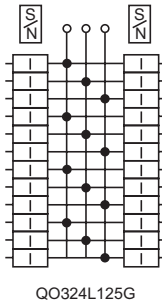
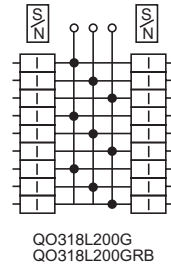
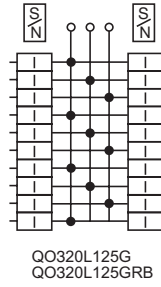
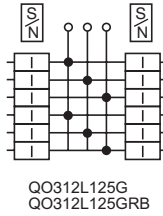
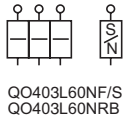

3-Phase, 4-Wire Main Lugs

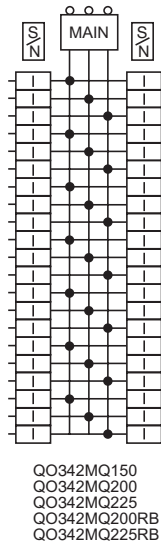
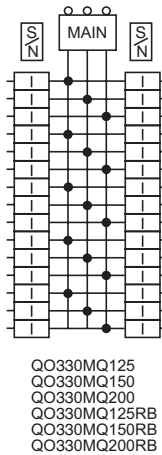
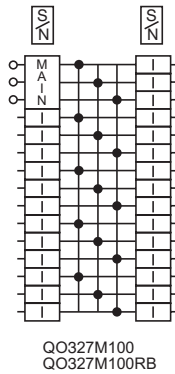

3-Phase, 4-Wire Main Circuit Breakers

QO[®], QOM2 and Q-Frame Enclosed Circuit Breakers—Class 1131

Table of Contents

TABLE OF CONTENTS

General Information and Application Data 34

Type 34
Service 34
Ratings 34
Enclosure 34
Type 3R Rainproof 34
Circuit Breakers 35
Knockouts 35
Equipment Grounding Bar 35
Neutral Assemblies 35
Bolt-On Hubs 35

Technical Information 36

Enclosed Molded-Case Circuit Breaker Ratings 36

Dimensions and Knockouts 37

NOTE: For information on Replacement Parts with specific part numbers, go to www.schneider-electric.us, click on Product FAQ's, enter the device catalog number, click SEARCH, then look for the information required.

QO[®], QOM2 and Q-Frame Enclosed Circuit Breakers—Class 1131
General Information and Application Data



QO2100BNS



QO2100BNRB



QOM22225NRB

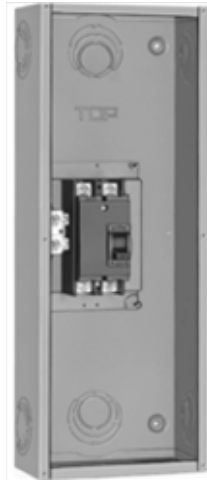

Q22200NS
 With Cover Removed
 (Order Q-Frame Circuit
 Breaker Separately)

GENERAL INFORMATION AND APPLICATION DATA

Type

Enclosed molded case circuit breakers are UL[®] Listed; File E136861, for enclosures and File E10027 for circuit breakers.

Molded case circuit breakers meet Federal Specifications W-C-375-B.

Enclosed molded case switches are UL Listed under File E59921.

Service

- 120/240 Vac, 1 ϕ 3W
- 240 Vac, 1 ϕ 2W
- 240 Vac, 1 ϕ 3W
- 240/120 Vac, 3 ϕ 4W
- 208Y/120 Vac, 3 ϕ 4W

Ratings

Enclosed Molded Case Circuit Breakers	
QO	10,000 A
QOM2	22,000 A
QB	10,000 A
QD	25,000 A
QG	65,000 A
QJ	65,000 A @ 240 V or 100,000 A @ 208Y / 120

Enclosure

- Type 1 indoor general purpose
- Welded sheet steel with knockouts at top, bottom, back and sides
- Finish: gray baked enamel, electrodeposited over cleaned, phosphatized steel
- Padlock provisions for locking circuit breaker handle in ON (I) or OFF (O) position
- Flush or surface mount covers

Type 3R Rainproof

- Welded, galvanized sheet steel
- Finish: gray baked enamel, electrodeposited over cleaned, phosphatized, galvanized steel
- Provisions to padlock cover closed
- RB devices have provisions for interchangeable bolt-on hubs

QO[®], QOM2 and Q-Frame Enclosed Circuit Breakers—Class 1131 General Information and Application Data

Circuit Breakers

Visi-Trip[®] indication (QO[®] circuit breakers)

Lugs suitable for aluminum or copper wire
(refer to catalog sections listed below:)



QOM2200VH

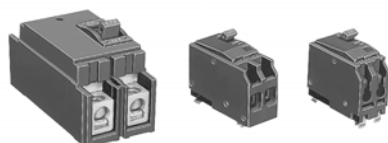

Circuit Breakers

Knockouts

Located in back, side and bottom of all devices

Equipment Grounding Bar

Field-installable PKOGTA2

Suitable for #6 AWG 2/0 aluminum or #10 AWG 2/0 AWG copper wire

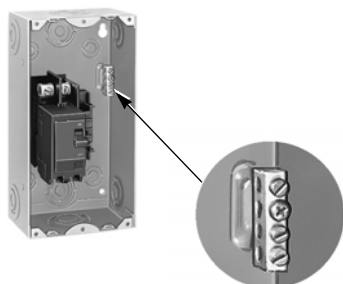

Factory-installed equipment grounding bar.

Neutral Assemblies

Insulated, groundable (except QO2TR)

Suitable for aluminum or copper wire

Grounding terminal provided

Bolt-On Hubs

Hubs available from 0.75 in. (19 mm) to 2.50 in. (64 mm) conduit size

Off-center thread openings keep conduit close to wall

No gasket required with hubs



PKOGTA2 field installed.

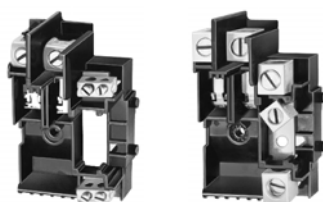

QO Base Assemblies



QOM2 Base



Neutral Assemblies







Hubs

QO[®], QOM2 and Q-Frame Enclosed Circuit Breakers—Class 1131

Technical Information

TECHNICAL INFORMATION

Enclosed Molded-Case Circuit Breaker Ratings

Service	Rating in Amperes	Enclosure		Enclosure No. (Page 37)	Circuit Breaker ¹			Neutral Assembly Terminal Wire Size AWG/kcmil	
		Type 1 Catalog Number	Type 3R Catalog Number		Catalog Number	UL [®] Listed Interrupting Rating in RMS Amps Symmetrical	Terminal Lug Wire Size AWG/kcmil	Neutral Terminals	Grounding Terminals
Enclosed Circuit Breaker Mounting Base									
 240 Vac	60 A ²		QO2TR ³	1R	QO210 to QO260	10,000 AIR	#14 4 Al or Cu ⁴		#14 8 Al or Cu
Enclosed Circuit Breakers									
 120/240 Vac	100 A	QO210BNF/S ⁵	QO210BNRB ⁵	1, 2R	QO QO-PL QO-GFI	10,000 AIR	#12 1 Al or #14 1 Cu	#12 1 Al or #14 1 Cu	#12 2 Al or #14 2 Cu
					QO-VH	22,000 AIR			
	125 A	QO2125BNF/S ⁵	QO2125BNRB ⁵	2, 3R	QO QO-PL QO-GFI	10,000 AIR	#12 2/0 Al #14 2/0 Cu	#12 2/0 Al #14 2/0 Cu	
	100-225 A	QOM22225NF/S ₆	QOM22225NRB ₆	6, 6R	QOM2-VH	22,000 AIR	4 - #4 2 50 kcmil Al/Cu	2 - #4 25 0 kcmil 4 - #14 2/0 Al or Cu	2 - #6 2/0 Al 2 - #10 2/0 Cu
 240 Vac	100 A	QO3100BNF/S ⁵	QO3100BNRB ⁵	1, 2R	QO QO-PL QO-GFI	10,000 AIR	#12 1 Al or #14 1 Cu	#12 1 Al or #14 1 Cu	#12 2 Al or #14 2 Cu
					QO-VH	22,000 AIR			
 2-pole 240 Vac Max.	100-225 A	Q22200NS ^{7 8}	Q22200NRB ^{7 8}	3, 4R	QBL QDL QGL QJL	10,000 AIR 25,000 AIR 65,000 AIR 100,000 AIR	#4 300 Al or Cu	#4 2 50 Al or Cu	#12 1/0 Al or #14 1/0 Cu
		Q23225NF/S ⁸	Q23225NRB ⁸	4, 5R				#4 3 00 Al or Cu	
 3-pole 240 Vac	100-225 A	Q23225NF/S ⁸	Q23225NRB ⁸	4, 5R	QBL QDL QGL QJL	10,000 AIR 25,000 AIR 65,000 AIR 100,000 AIR ⁹			

- ¹ Order circuit breaker separately.
- ² Not suitable for service equipment.
- ³ Top endwall has no hub opening; back and bottom feed only.
- ⁴ Load terminals use #6 maximum.
- ⁵ Enclosures will accept QO circuit breakers with factory-installed accessories.
- ⁶ Enclosure will accept QOM2 circuit breaker with factory-installed accessories.
- ⁷ Accepts 200 A maximum, 2-pole Q-frame circuit breakers.
- ⁸ Equipment grounding kit factory-installed.
- ⁹ When these 3-pole circuit breakers are mounted in an enclosure, the maximum AIR rating is 65,000 at 240 Vac and 100,000 at 208 Vac.

QO[®], QOM2 and Q-Frame Enclosed Circuit Breakers—Class 1131

Dimensions and Knockouts

DIMENSIONS AND KNOCKOUTS

Enclosure No.	Dimensions					
	W		H		D	
	in.	mm	in.	mm	in.	mm
1	5.88	149	13.12	333	3.38	86
2	5.88	149	16.12	409	3.38	86
1R	4.56	116	6.50	165	3.88	99
2R	6.92	176	13.12	333	4.12	105
3R	6.92	176	16.12	409	4.12	105
3	7.56	192	23.12	587	4.25	108
4	9.62	244	26.12	663	4.75	121
4R	7.56	192	23.24	590	4.75	121
5R	9.62	244	26.24	666	5.50	140
6	8.55	217	23.92	608	3.95	100
6R	8.55	217	24.75	629	4.16	106

Symbol	Knockouts							
	A	B	C	D	E	F	G	H
Conduit Size	0.50 in. 13 mm	0.75 in. 19 mm	1.00 in. 25 mm	1.25 in. 32 mm	1.50 in. 38 mm	2.00 in. 51 mm	2.50 in. 64 mm	3.00 in. 76 mm

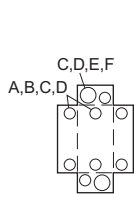

Box 1, 2



Box 1R

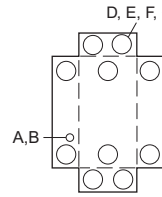

Box 3

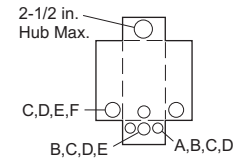

Box 2R, 3R

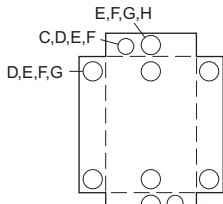

Box 4

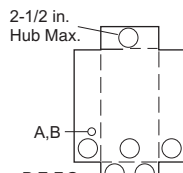

Box 4R

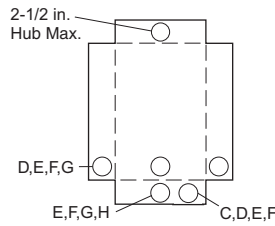

Box 5R

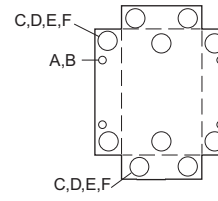

Box 6

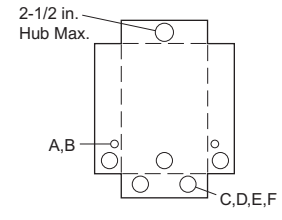

Box 6R

Outdoor Dimensions and Knockouts

**QO[®], QOM2 and Q-Frame Enclosed Circuit Breakers—Class 1131
Dimensions and Knockouts**

Homeline® Circuit Breakers and Load Centers—Class 1170

Table of Contents

TABLE OF CONTENTS

Product Description 40

Features 40
Homeline® Catalog Number Description 41

General Information and Application Data 42

Type 42
Service 42
Ratings 42
UL Listed 42
Class CTL 42
Branch Circuit Breakers 42
Main Circuit Breaker QOM-VH 42
Indoor Enclosures (NEMA Type 1) 43
Indoor Covers 43
Rainproof Enclosures (NEMA Type 3R) 43
Bolt-On Hubs 43
Single-Phase, 2 12 Circuits, 70 125 A, Fixed Mains 44
Single-Phase, 12 4 2 Circuits, 100 2 25 A, Convertible Mains 44
Surgebreaker® Secondary Surge Arrester 46
Accessories 46

Technical Information 48

Grounding Bar Kits 48
Wire Range Table 48
Main Lugs and Main Circuit Breakers Ratings 49

Dimensions and Knockouts 26-28

Homeline® Label Samples 52

Wiring Diagrams 53

INDEX 55

Homeline® Circuit Breakers and Load Centers—Class 1170

Product Description

PRODUCT DESCRIPTION

Homeline® circuit breaker load centers from Square D® are UL Listed panelboards. They are designed to meet residential, commercial, and industrial requirements to protect electrical systems, equipment, and people.



Homeline® Circuit Breaker Load Center

Features

- Single-phase construction
- 30 2 25 A main lug or main circuit breaker ratings
- 2 42 circuit indoor or outdoor versions
- Combination cover for flush or surface mounting
- Aluminum bus construction on main lug or main circuit breaker panels
- Service entrance equipment capable panels
- Straight-in wiring to help minimize service cable installation
- Convertible mains meet changing job site requirements
- Standard 22/10 k AIR series rating on main circuit breaker panels increases application capability
- Single captive screw interior mounting on indoor panels to ease removal
- Split branch neutral for clutter-free wiring
- Top or bottom feed by rotating convertible mains panels 180 degrees
- Combination slot/square drive neutral, ground, and cover screws for positive drive and improved torque
- Three ground bar mounting locations for ease of wiring
- Automatic flush adjustment cover speeds installation
- Tangential main service knockouts eliminate offsets
- Equipment grounding bar included with main lug load centers
- Cover supplied with load center
- Provisions for door lock on convertible mains panel covers
- Two branch circuit breaker twistouts are factory removed for easier installation of circuit breakers
- New side hinge doors on outdoor convertible main panels
- Outdoor panel covers are lockable with padlock

Homeline® Circuit Breakers and Load Centers—Class 1170 Product Description

Homeline® Load Centers

Number Segment	Character	Description	HOM	3040	L	200	—	C
Load Center Family	HOM	UL Listed						
Spaces / Circuits	3040							
Mains Type	M	Main circuit breaker						
	L	Main lugs						
	U	Universal mains						
Amps								
Ground Bar	G	Factory included						
	T	Factory-installed						
	Blank	Purchase separately						
Special Construction	FT	Feed-thru						
Cover	C	Combination flush / surface indoor cover						
	F	Flush						
	RB	Rainproof						
	S	Surface						

Homeline® Circuit Breakers

Number Segment	Character	Description	HOM	1	15	—
Brand	HOM	Full Size				
	HOMT	Tandem				
Number of Poles						
Amps						
Device Name	AFI	Arc fault circuit interruption				
	Blank	10,000 AIR				
	CAFI	Combination arc fault circuit interruption				
	EPD	Equipment protection device				
	GFI	Ground fault circuit interruption				
	HM	High magnetic trip				

Homeline® Circuit Breakers and Load Centers—Class 1170

General Information and Application Data

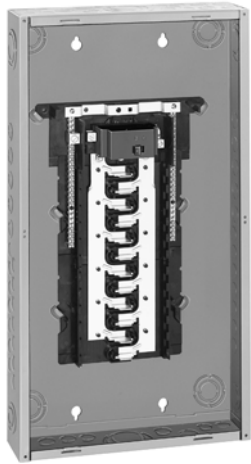

HOM24M125C

GENERAL INFORMATION AND APPLICATION DATA

Type

Circuit breaker load centers for use on ac systems. They are UL Listed under file E-6294 (panelboards) and meet Federal Specifications W-P-115b NEMA Type 1, Class 2.

Service

120 Vac, 1 ϕ 2W
120/240 Vac, 1 ϕ 3W

Ratings

Main lugs: 70 2 25 A
Main circuit breaker: 50 2 25 A

UL Listed

File E-6294 (panelboards)
Suitable for use as service equipment
75 °C wire rating

Class CTL

UL Listed Class CTL load centers
Meets the National Electrical Code® (NEC®) article for Lighting and Appliance Branch Circuit panelboards.



HOM 1-Pole
1 space required.

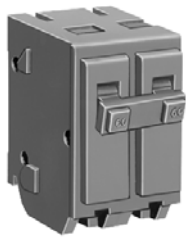

HOM 2-Pole
2 spaces required.



HOMT 1-Pole Tandem
1 space required.



HOMT Quad Circuit Breaker
2 spaces required.

Branch Circuit Breakers

10,000 AIR	
HOM	1-pole, 15 5 0 A
	2-pole, 15 1 25 A
HOMT	1-pole, 15 3 0 A
	2-pole, 15 5 0 A
HOM-GFI	1-pole, 15 2 0 A
	2-pole, 15, 20, 30, 40, 50 A
HOM-AFI	1-pole, 15 2 0 A
HOM-CAFI	1-pole, 15 2 0 A

Main Circuit Breaker Kits

50 225 A main circuit breaker kit is 22,000 AIR series rated with 10,000 AIR branch circuit breakers

Refer to Main Circuit Breaker Kits on page 10 for listing.



HOM 1-Pole GFI with ground fault circuit interrupter; 1 space required.



HOM 2-Pole GFI with ground fault circuit interrupter; 2 space required.



HOM-AFI
1 space required.



HOM-CAFI
1 space required.

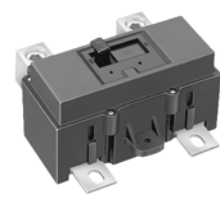

QOM2 Frame Size
100–225 A



QOM1 Frame Size
50–125 A

Homeline® Circuit Breakers and Load Centers—Class 1170 General Information and Application Data

Indoor Enclosures (NEMA Type 1)



HOM40M200C With Cover

Welded sheet steel with knockouts at top, bottom, back and sides
Finish: gray baked enamel electrodeposited over cleaned, phosphatized steel
Most indoor enclosures are 14.25 in (362 mm) wide
Top or bottom feed by rotating enclosure

Indoor Covers

Doors to cover circuit breaker handles, except on 2 4 , 4 8 and 6 1 2 circuit models
Combination flush and surface cover with latch opening door included with load centers
Automatic flush adjustment is standard
Triple lead cover screws for fast cover installation
Shutter-type twistouts
HOMFP snap-in style filler plates available for all covers
QOM1FP filler plates available for 100 12 5 A convertible load center covers
QOM2FP filler plates available for 150 22 5 A convertible load center covers



New RB Device

Rainproof Enclosures (NEMA Type 3R)

Complete enclosure includes interior trim and door
Welded galvanized steel
Finish: gray baked enamel electrodeposited over cleaned, phosphatized, galvanized steel
RB devices have provisions for interchangeable bolt-on hub
Top centered rainproof mounting boss on the back of the enclosure simplifies installation and saves time
Stainless steel door latch on the enclosure provides a secure closure and maximum durability
Convertible main panels are side-hinge door devices
Side-hinged door provides full wiring access without door removal
Allow 1.25 in (32 mm) on the left side for the door to open



Bolt-On Hubs

Bolt-On Hubs

Hubs available for 0.75 in (19 mm) to 4 in (102 mm) conduit size (see page 46)
No gasket required with hubs from 0.75 in (19 mm) to 2.50 in (64 mm) when used on RB type load centers

Homeline® Circuit Breakers and Load Centers—Class 1170

General Information and Application Data

Single-Phase, 2–12 Circuits, 70–125 A, Fixed Mains

UL Listed

File E-6294

Suitable for use as service equipment

75 °C wire rating (see Technical Information on page 49)

Short Circuit Current Rating

Main lugs: up to 10,000 AIR (see Technical Information on page 49)

Interior

Tin plated aluminum bus

Mains

Factory-installed fixed main lugs

Top mains positioning only

Top or bottom feed (see Technical Information on page 49)

A backfed main circuit breaker can be field installed in a 6 1/2 load center using the HOM1RK retaining kit

Cover

Combination flush and surface cover



HOM612L100F



Flush Cover



Combination Cover with Door

Single-Phase, 12–42 Circuits, 100–225 A, Convertible Mains

UL Listed

File E-6294

Suitable for use as service equipment

75 °C wire rating (see Technical Information on page 48)

Short Circuit Current Rating

Main lugs: up to 10,000 AIR

Main circuit breaker: 22,000 AIR standard (see Technical Information on page 48)

Interior

Tin plated aluminum bus

Removable interior with single, captive mounting screw

Split branch neutral with up to 50% more terminations than required

Multiple mounting locations for equipment ground bar kits: left, right, bottom

Mains

Factory-Installed Main Lugs Convertible to Main Circuit Breaker		Factory-Installed Main Circuit Breaker Convertible to Main Lugs		
Load Center Amperage	Main Circuit Breaker Kit Amperage	Main Circuit Breaker Amperage	Main Lug Kit Amperage	Load Center Amperage
125	50 - 125	100	125	100
150	100 - 150	125	125	125
200	100 - 200	150	225	150
225	100 - 225	200	225	200
		225	225	225

Top or bottom mains positioning, by rotating the complete indoor load center 180 degrees.
(see Technical Information on page 48)

Homeline® Circuit Breakers and Load Centers—Class 1170 General Information and Application Data

Single-Phase, 12–42 Circuit, 100–225 A, Convertible Mains, Continued

Cover

- Combination flush and surface cover included with load centers
- Optional door lock kit for indoor load centers
- Positive action, easy open door latch

Main Circuit Breaker with Feed-Thru Lugs

- Rainproof only, side hinged
- 150 and 200 A mains rating
- Space for up to 8 single-pole circuit breakers
- Factory-installed main circuit breaker
- Factory-installed feed-thru lugs



HOM816M200FTRB

Universal Mains Load Centers, Studs Only

- No factory-installed main circuit breaker or main lugs
- 200 A mains rating
- Indicated by a U in the catalog number
- Purchase main lug kit or main circuit breaker kit and field install
- Combination flush / surface cover included with indoor load center
- Factory-installed ground bar kit



HOM816U200FTRB

Universal Mains Load Center with Feed-Thru Lugs

- No factory-installed main circuit breaker or main lugs
- 200 A mains rating
- Feed-thru lugs are factory-installed
- Rainproof only, side hinged
- Space for up to 8 single-pole circuit breakers
- Purchase main lug kit or main circuit breaker kit and field install

Main Circuit Breaker Mobile Home Load Centers

- Covers included with load centers
- Factory-installed grounding bar, indicated by a T in the catalog number
- Top or bottom feed on incoming service by rotating the complete load center 180 degrees



HOM3040U200TC

Homeline® Circuit Breakers and Load Centers—Class 1170

General Information and Application Data

Accessories

Bolt-On Hubs

Equipment with an RB suffix, meaning Rainproof NEMA Type 3R construction, uses the bolt-on hubs listed below. RB devices will accept 0.75 in (19 mm) through 2.50 in (64 mm) bolt-on hubs without the use of reducers.

Off-center conduit thread openings and elongated mounting holes provide quick and easy adjustment to eliminate costly conduit offsets and bends. Hubs are suitable for use with conduit having ANSI standard taper pipe thread.

UL Listed Bolt-On Hubs for RB Devices

Conduit Size	0.75 in 9 mm	1.00 in 25 mm	1.25 in 32 mm	1.50 in 38 mm	2.00 in 51 mm	2.50 in 64 mm
Hub Cat. No.	B075	B100	B125	B150	B200	B250

NOTE: Closing cap (catalog number B-CAP) is provided factory-installed on each device having the RB suffix.

UL Listed Enclosure Coupling for RB Devices

Cat. No.	Designed for connecting wireway or other enclosures to units having RB bolt-on conduit provisions. Provides a bushed opening equal to 2 in conduit. Eliminates the need for conduit nipling.
BC200	

Surgebreaker® Secondary Surge Arrester

HOM2175SB UL Listed secondary surge arrester

Easy plug-on installation for Homeline® load center

LED indicates operational status

Plug-on design requires two pole spaces

Designed to protect electrical service and major household appliances, excluding electronic devices

Grounding Bar Kits

Field installable in all load centers

Wire size of terminals (see Technical Information on page 48)

Suitable for copper or aluminum wire

Available with #1 4/0 AWG lug PK15GTA-L, PK18GTA-L and PK23GTA-L (see Technical Information on page 48)

Auxiliary Neutral Lugs

UL Listed for copper or aluminum wire

Field installable on neutral assembly

LK70AN: #12 2 Al or #14 4 Cu AWG

LK100AN: #6 2/0 Al/Cu AWG

LK125AN: #14 2/0 Al/Cu AWG

Cover Filler Plates

Fast to install; snap-in type

HOMFP branch circuit

QOM1FP 50 1 25 A main circuit breaker

QOM2FP 150 225 A main circuit breaker



RB Hub

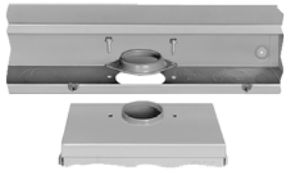

BC200 Enclosure Coupling



HOM Surgebreaker®
Surge Arrester
2 spaces required.



PK15GTA



LK100AN

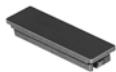

HOMFP

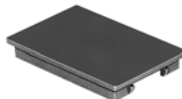

QOM1FP



QOM2FP

Homeline® Circuit Breakers and Load Centers—Class 1170

General Information and Application Data



Back-Fed Main Circuit Breaker Retaining Kit

Back-Fed Main Circuit Breaker Retaining Kits

HOM1RK: secures circuit breaker to interior when used as back-fed main for HOM612L100F/S and RB load centers

HOM4RK2LA: mounts on the right side of HOM 100 125 A convertible main load centers, series S01 and S02 (retains one 2-pole HOM circuit breaker)

HOM4RK2HA: mounts on the right side of HOM 150 225 A convertible main load centers, series S01 and S02 (retains one 2-pole HOM circuit breaker)



Cutaway Showing Installed Generator Interlock Kit

Generator Circuit Breaker Interlock Kit

HOMCRBGK1: interlocks a QOM1 2-pole main circuit breaker of a load center (100 125 A) with a Homeline® 2-pole (15 125 A) branch circuit breaker, "S" series NEMA Type 1 and "S1" and "S2" series NEMA type 3R load centers

HOMCGK2: interlocks a QOM2 2-pole main circuit breaker of a load center (150 225 A) with a Homeline 2-pole (15 125 A) branch circuit breaker, S series NEMA Type 1 and S01 series NEMA Type 3R load centers

HOMRBGK2: interlocks a QOM2 2-pole main circuit breaker of a load center (150 225 A) with a Homeline 2-pole (15 125 A) branch circuit breaker, S02 series NEMA Type 3R load centers

Flush Lock Kits

Available for indoor load centers

Two keys provided with each lock kit

PK6FL for single-phase convertible 8 42 circuit load centers



PK6FL

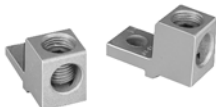

QOL125

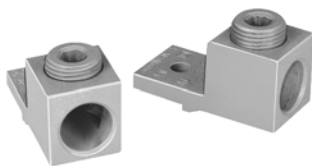

QOL225

Main Lugs Kits

Field installable in main circuit breaker or main lugs load centers

125 A kit usable in 100 125 A load centers, QOL125

225 A kit usable in 150 225 A load centers, QOL225

Main Circuit Breaker Kits

Field installable in main lugs or main circuit breaker load centers

50 225 A main circuit breaker kit with 22,000 AIR usable with 10,000 AIR branch circuit breakers (see page 10)

TECHNICAL INFORMATION

Grounding Bar Kits

All PK equipment grounding bar kits are supplied with mounting screws, necessary installation instructions and an Equipment Grounding Terminal self-adhesive label.

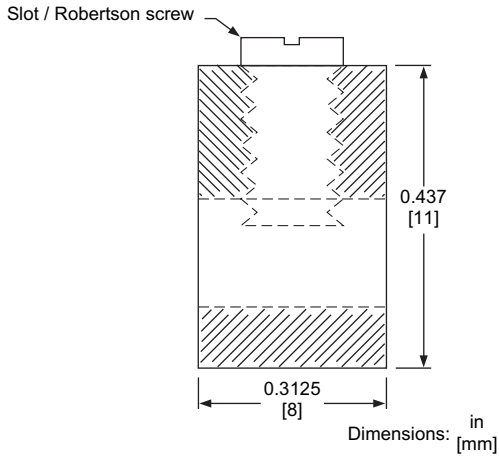

Cross Section of Size 1 Ground Bar

Catalog Number	Total Qty.	Terminals						Approximate Overall Length		Distance Between Mounting Holes		Mounting
		Quantity Each Size See "Wire Range Table" below.						in	[mm]	in	[mm]	
		I	II	III	IV	V	VI					
PK0GTA2 ¹	2						2	1.75	[44]	One hole	One hole	Top
PK0GTA6 ²	6					6		4.61	[117]	1.69	[43]	Top
PK3GTA1 ³	3	3						1.38	[35]	One hole	One hole	Top
PK4GTA ³	4	4						1.63	[41]	One hole	One hole	Top
PK5GTA ⁴	5	5						2.25	[57]	1.25	[32]	Top
PK7GTA ³	7	7						2.88	[73]	1.25	[32]	Top or Side
PK9GTA1 ³	9	9						3.25	[83]	One hole	One hole	Top
PK9GTA ³	9	9						3.78	[96]	3.13	[80]	Top
PK12GTA ³	12	12						4.70	[119]	3.13	[80]	Top
PK15GTA ³	15	15						5.63	[143]	3.13	[80]	Top
PK15GTAL ⁵	16	15	1					8.13	[207]	3.13	[80]	Top
PK15GTA6 ⁶	21	15			6			5.88	[149]	7	7	Top
PK18GTA ³	18	18						6.56	[167]	3.13	[80]	Top
PK18GTAL ⁵	19	18	1					8.81	[224]	3.13	[80]	Top
PK23GTA ³	23	23						8.11	[206]	3.13	[80]	Top
PK23GTAL ⁵	24	23	1					9.44	[240]	3.13	[80]	Top
PK27GTA ^{3 8}	27 or 26	27 or 26		1				9.36	[238]	3.13	[80]	Top

- ¹ Mounting screw 40205-065-01 (one required).
- ² Mounting screw 21922-18360 (two required).
- ³ Mounting screw 21594-14220 (two required).
- ⁴ Mounting screw 21594-14241 (two required).
- ⁵ Mounting screw 21594-14302 (two required).
- ⁶ Mounting screws 21594-14241 (two required) and 21594-17121 (two required).
- ⁷ 3.13 in. (80 mm) on small terminals; 5.25 in. (133 mm) on large terminals.
- ⁸ PK27GTA includes one main grounding lug that mounts with two terminal screws and requires three terminals for mounting.

Wire Range Table

Size	Cu (AWG)	Al (AWG)
I	(1) #14 #4 or (2) #14 or #12	(1) #12 #4 or (2) #12 or #10
II	(1) #1 4 /0	(1) #1 4 /0
III	(1) #6 2 /0	(1) #6 2 /0
IV	(1) #6 3 /0	(1) #6 3 /0
V	(1) #14 1 /0	(1) #14 1 /0
VI	(1) #10 2 /0	(1) #6 2 /0

Homeline® Circuit Breakers and Load Centers—Class 1170

Main Lugs and Main Circuit Breakers Ratings

MAIN LUGS AND MAIN CIRCUIT BREAKERS RATINGS

Single-Phase, Three-Wire, 120/240 Vac Main Lugs Indoor

Mains Rating in Amps	Load Center Catalog Number	LoadCenter Cover Catalog Number	UL Listed Service Equipment (See Notes)	Maximum UL Short Circuit Rating ¹	MainWireSize AWG/kcmil Al/Cu	Enclosure No. (Page 27)	Top or Bottom Mains Position	UL Listed for Corner Grounded Delta Systems
----------------------	----------------------------	---------------------------------	---	--	------------------------------	-------------------------	------------------------------	---

Fixed Mains – Factory-Installed Main Lugs

70	HOM24L70F/S	Included	B	10,000 A	#12 3 #14 4	2	Top	No
100	HOM612L100F/S	Included	B, C	10,000 A	#8 1	4	Top	No
125	HOM48L125GC	Included	B, C	10,000 A	#4 2/ 0	21	Top	No

Convertible Mains – Factory-Installed Main Lugs

QOM1 Main Frame Size – Convertible to 22,000 AIR Main Circuit Breaker

125	HOM816L125C	Included	B, C	10,000 A	#6 2/ 0	6	Both	No
	HOM816L125TC	Included	B, C	10,000 A	#6 2/ 0	6	Both	
	HOM12L125C	Included	B, C	10,000 A	#6 2/ 0	6	Both	
	HOM1224L125TC	Included	B, C	10,000 A	#6 2/ 0	6	Both	
	HOM1624L125C	Included	B, C	10,000 A	#6 2/ 0	8	Both	
	HOM20L125C	Included	B, C	10,000 A	#6 2/ 0	8	Both	
	HOM20-24L125TC	Included	B, C	10,000 A	#6 2/ 0	8	Both	
	HOM24L125TC	Included	B, C	10,000 A	#6 2/ 0	8	Both	

Convertible Mains – Factory-Installed Main Lugs

QOM2 Main Frame Size – Convertible to 22,000 AIR Main Circuit Breaker

150	HOM30L150C	Included	B, C	10,000 A	#4 250	10	Both	No
	HOM30L150TC	Included	B, C	10,000 A	#6 250	10	Both	
200	HOM1632L200TC	Included	B, C	10,000 A	#4 250	9	Both	
	HOM1632L200TCFT ²	Included	B, C	10,000 A	#6 250	10	Both	
	HOM2040L200TC	Included	B, C	10,000 A	#6 250	9	Both	
	HOM30L200C	Included	B, C	10,000 A	#6 250	10	Both	
	HOM30L200TC	Included	B, C	10,000 A	#6 250	9	Both	
	HOM3040L200TC	Included	B, C	10,000 A	#6 250	10	Both	
	HOM40L200C	Included	B, C	10,000 A	#6 250	12	Both	
225	HOM40L200TC	Included	B, C	10,000 A	#6 250	12	Both	
225	HOM42L225C	Included	B, C	10,000 A	#6 250	10	Both	

¹ UL short circuit rating with optional QOM-VH main circuit breaker, 22,000 AIR.

² Supplied with feed-thru lugs.

B UL Listed as suitable for use as service equipment (neutral bonded at the time of installation) with field-installed service disconnect.

C UL Listed as suitable for use as service equipment (neutral bonded at the time of installation) when not more than six service disconnecting means are provided and when not used as a lighting and appliance branch circuit panelboard.

Homeline® Circuit Breakers and Load Centers—Class 1170

Main Lugs and Main Circuit Breakers Ratings

Single-Phase, Three-Wire, 120/240 Vac Main Circuit Breaker Indoor

Mains Rating in Amps	Load Center Catalog Number	Load Center Cover Catalog Number	UL Listed Service Equipment (See Notes)	Maximum UL Short Circuit Rating ¹ ▲	Main Wire Size AWG/kcmil Al/Cu	Enclosure No. (Page 27)	Top or Bottom Mains Position	UL Listed for Corner Grounded Delta Systems
----------------------	----------------------------	----------------------------------	---	--	--------------------------------	-------------------------	------------------------------	---

Convertible Mains – Factory-Installed Main Circuit Breaker
QOM1 Main Frame Size – Convertible to Main Lugs

100	HOM816M100C	Included	A, C	22,000 A	#6 1	5	Both	No
	HOM816M100TC	Included	A, C	22,000 A	#6 1	5	Both	
	HOM12M100C	Included	A, C	22,000 A	#4 2 /0	6	Both	
	HOM1224M100TC	Included	A, C	22,000 A	#4 2 /0	6	Both	
	HOM20M100C	Included	A, C	22,000 A	#4 2 /0	8	Both	
	HOM24M100C	Included	A, C	22,000 A	#4 2 /0	8	Both	
	HOM30M100C	Included	A, C	22,000 A	#4 2 /0	10	Both	
125	HOM1224M125C	Included	A, C	22,000 A	#4 2 /0	6	Both	No
	HOM1224M125TC	Included	A, C	22,000 A	#4 2 /0	6	Both	
	HOM24M125C	Included	A, C	22,000 A	#4 2 /0	8	Both	
	HOM30M125C	Included	A, C	22,000 A	#4 2 /0	10	Both	

Convertible Mains – Factory-Installed Main Circuit Breaker
QOM2 Main Frame Size – Convertible to Main Lugs

150	HOM1632M150TC	Included	A, C	22,000 A	#4 250	9	Both	No
	HOM2030M150TC	Included	A, C	22,000 A	#4 250	9	Both	
	HOM30M150C	Included	A, C	22,000 A	#4 250	10	Both	
200	HOM1224M200TC	Included	A, C	22,000 A	#4 250	9	Both	No
	HOM1632M200TC	Included	A, C	22,000 A	#4 250	9	Both	
	HOM2040M200C	Included	A, C	22,000 A	#4 250	9	Both	
	HOM2040M200TC	Included	A, C	22,000 A	#4 250	9	Both	
	HOM30M200C	Included	A, C	22,000 A	#4 250	10	Both	
	HOM3040M200TC	Included	A, C	22,000 A	#4 250	10	Both	
	HOM40M200C	Included	A, C	22,000 A	#4 250	12	Both	
225	HOM42M200C	Included	A, C	22,000 A	#4 250	12	Both	No
	HOM42M225C	Included	A, C	22,000 A	#4 250	12	Both	

Universal Mains – No Factory-Installed Main Circuit Breaker or Main Lugs
QOM2 Main Frame Size – Field-Installed Main Lugs or 22,000 AIR Main Circuit Breaker

200	HOM1632U200TC	Included	B, C	10,000 A	#4 250	9	Both	No
	HOM2040U200TC	Included	B, C	10,000 A	#4 250	9	Both	
	HOM3040U200TC	Included	B, C	10,000 A	#4 250	10	Both	

¹ UL short circuit rating with optional QOM-VH main circuit breaker, 22,000 AIR.

A UL Listed as suitable for use as service equipment (neutral bonded at the time of installation) with a factory-installed service disconnect.

B UL Listed as suitable for use as service equipment (neutral bonded at the time of installation) with field-installed service disconnect.

C UL Listed as suitable for use as service equipment (neutral bonded at the time of installation) with field-installed main lugs when not more than six disconnecting means are provided and when not used as lighting and appliance branch circuit panelboard.

Homeline® Circuit Breakers and Load Centers—Class 1170

Main Lugs and Main Circuit Breakers Ratings

Single-Phase, Three-Wire, 120/240 Vac Main Lugs Rainproof

Mains Rating in Amps	Load Center Catalog Number	Load Center Cover Catalog Number	UL Listed Service Equipment (See Notes)	Maximum UL Short Circuit Rating ¹ ▲	Main Wire Size AWG/kcmil Al/Cu	Enclosure No. (Page 28)	Top or Bottom Mains Position	UL Listed for Corner Grounded Delta Systems
----------------------	----------------------------	----------------------------------	---	--	--------------------------------	-------------------------	------------------------------	---

Fixed Mains – Factory-Installed Main Lugs

70	HOM24L70RB	Included	B	10,000 A	#12 3 Al #14 4 Cu	1R	Top	No
100	HOM612L100RB	Included	B, C	10,000 A	#8 1	2R	Top	No
125	HOM48L125GRB	Included	B, C	10,000 A	#12 2/0 Al #14 2/0 Cu	16R	Top	No

Convertible Mains – Factory-Installed Main Lugs – QOM1 Main Frame Size – Convertible to 22,000 AIR Main Circuit Breaker

125	HOM816L125RB	Included	B, C	10,000 A	#6 2/0	3R	Top	No
	HOM12L125RB	Included	B, C	10,000 A	#6 2/0	3R	Top	
	HOM1224L125RB	Included	B, C	10,000 A	#6 2/0	3R	Top	
	HOM20L125RB	Included	B, C	10,000 A	#6 2/0	4R	Top	

Convertible Mains – Factory-Installed Main Lugs – QOM2 Main Frame Size – Convertible to 22,000 AIR Main Circuit Breaker

200	HOM12L200RB	Included	B, C	10,000 A	#6 250	5R	Top	No
	HOM2040L200RB	Included	B, C	10,000 A	#6 250	6R	Top	
	HOM30L200RB	Included	B, C	10,000 A	#6 250	7R	Top	
	HOM40L200RB	Included	B, C	10,000 A	#6 250	8R	Top	

Single-Phase Three Wire 120/240 Vac Main Breaker Rainproof

**Convertible Mains – Factory-Installed Main Circuit Breaker
QOM1 Main Frame Size – Convertible to Main Lugs or Lower Amperage Main Circuit Breaker**

100	HOM816M100RB	Included	A, C	22,000 A	#4 2/0	3R	Top	No
	HOM12M100RB	Included	A, C	22,000 A	#4 2/0	3R	Top	
	HOM20M100RB	Included	A, C	22,000 A	#4 2/0	4R	Top	
	HOM24M100RB	Included	A, C	22,000 A	#4 2/0	6R	Top	
125	HOM24M125RB	Included	A, C	22,000 A	#4 2/0	6R	Top	No

**Convertible Mains – Factory-Installed Main Circuit Breaker
QOM2 Main Frame Size – Convertible to Main Lugs or Lower Amperage Main Circuit Breaker**

150	HOM30M150RB	Included	A, C	22,000 A	#4 250	7R	Top	No
200	HOM2040M200RB	Included	A, C	22,000 A	#4 250	6R	Top	No
	HOM30M200RB	Included	A, C	22,000 A	#4 250	7R	Top	
	HOM3040M200RB	Included	A, C	22,000 A	#4 250	7R	Top	
	HOM40M200RB	Included	A, C	22,000 A	#4 250	8R	Top	
225	HOM1624M225RB	Included	A, C	22,000 A	#4-250		Top	No
	HOM42M225RB	Included	A, C	22,000 A	#4-250		Top	

Factory-Installed Main Circuit Breaker with Feed-Thru Lugs

150	HOM816M150FTRB	Included	A, C	22,000 A	#4 250	6R	Top	No
200	HOM816M200FTRB	Included	A, C	22,000 A	#4 250	6R	Top	No

Universal Main Circuit Breaker with Feed-Thru Lugs

200	HOM816U200FTRB	Included	B	22,000 A	#4 250	6R	Top	No
-----	----------------	----------	---	----------	--------	----	-----	----

¹ UL short circuit rating with optional QOM-VH main circuit breaker, 22,000 AIR.

A UL Listed as suitable for use as service equipment (neutral bonded at time of installation) with factory-installed service disconnect.

B UL Listed as suitable for use as service equipment (neutral bonded at time of installation) with field-installed service disconnect.

C UL Listed as suitable for use as service equipment (neutral bonded at the time of installation) with field-installed main lugs when not more than six service disconnecting means are provided and when not used as a lighting and appliance branch circuit panelboard.

Homeline® Circuit Breakers and Load Centers—Class 1170

Homeline Label Samples

HOMELINE LABEL SAMPLES

For information on two-tier and three-tier series ratings, see Data Bulletin number 4100DB0301, Square D® Load Center Short Circuit Current Ratings, located on the Technical Library at www.SquareD.com.

Homeline Box Label Sample

<p>Number of circuits maximum. Enclosure catalog number. Catalog number of covers; flush or surface. See panelboard interior for the catalog number. Voltage ratings. Amperage rating.</p>	<p>Wire range for lug torque data table.</p>	<p>Short circuit ratings. Short circuit ratings and additional of replacement circuit breakers.</p>	<p>UL listing.</p>																																												
<p>HOM LOAD CENTER See Panelboard interior for Catalog No. Box Cat. No. / Caja No. de Catalogo: BXH34A Use Cover Cat. No. / Utilice la Cubierta No. de Catalogo: HOMC30UC Mains 200A max. / Lina Principal de. 200A maximo. See main or service disconnect rating if installed. 120/240 V ~ Max. 1Ø, 50 / 60 Hz. 30 circuit max. / 30 circuitos maximo. Type 1 Enclosure Gabinete Tipo 1 For installation, repairs or alterations, Call an electrical contractor or electrician.</p>	<p>LUG TORQUE DATA See circuit breakers and field installed units for wire binding screw torque</p> <table border="1" style="width:100%; border-collapse: collapse;"> <thead> <tr> <th>Wire Range (AWG/kcmil)</th> <th>Torque (in.lbs.)</th> </tr> </thead> <tbody> <tr> <td>4 - 250 CU/AL</td> <td>250</td> </tr> <tr> <td>Service Ground Lug</td> <td>50</td> </tr> <tr> <td>Alternate Main Breaker</td> <td>See Main Breaker</td> </tr> </tbody> </table> <p>Branch Neutral and Equipment Ground Bar</p> <table border="1" style="width:100%; border-collapse: collapse;"> <thead> <tr> <th>Wire Range (AWG)</th> <th>Torque (in.lbs.)</th> </tr> </thead> <tbody> <tr> <td>8 CU / AL</td> <td>Large 45</td> </tr> <tr> <td>8 CU / AL</td> <td>Large 40</td> </tr> <tr> <td>14-10 CU, 12-10 AL</td> <td>Large 35</td> </tr> </tbody> </table> <p>Equipment Ground Combinations</p> <table border="1" style="width:100%; border-collapse: collapse;"> <tbody> <tr> <td>Two 14 or 12 CU</td> <td>25</td> </tr> <tr> <td>Two 12 or 10 AL</td> <td>10</td> </tr> </tbody> </table>	Wire Range (AWG/kcmil)	Torque (in.lbs.)	4 - 250 CU/AL	250	Service Ground Lug	50	Alternate Main Breaker	See Main Breaker	Wire Range (AWG)	Torque (in.lbs.)	8 CU / AL	Large 45	8 CU / AL	Large 40	14-10 CU, 12-10 AL	Large 35	Two 14 or 12 CU	25	Two 12 or 10 AL	10	<p>SHORT CIRCUIT RATING RMS Symmetrical Amperes at 120 / 240 V ~ Maximum</p> <table border="1" style="width:100%; border-collapse: collapse;"> <thead> <tr> <th>Panel Rating</th> <th>Remote Main</th> <th>Integral Main</th> <th>Branch (min.) Cat. prefix</th> </tr> </thead> <tbody> <tr> <td>42,000</td> <td>QOH</td> <td>Main Lugs</td> <td>10,000 / HOM</td> </tr> <tr> <td>22,000</td> <td>QOME..VH</td> <td>Lugs</td> <td>10,000 / HOM</td> </tr> <tr> <td>*10,000</td> <td>---</td> <td>Lugs</td> <td>10,000 HOM</td> </tr> <tr> <td>22,000</td> <td>---</td> <td>QOM2..VH</td> <td>10,000 HOM</td> </tr> <tr> <td>10,000</td> <td>---</td> <td>QOM2</td> <td>10,000 HOM</td> </tr> </tbody> </table> <p>*The rating is equal to the lowest interrupting rating of any circuit breaker installed. Refer to branch breaker for individual ratings. Additional or replacement branch circuit breakers, main breaker, or service disconnect MUST have an interrupting rating equal to or greater than that of the circuit breaker with the lowest interrupting rating presently installed. See panelboard interior for breaker types.</p>	Panel Rating	Remote Main	Integral Main	Branch (min.) Cat. prefix	42,000	QOH	Main Lugs	10,000 / HOM	22,000	QOME..VH	Lugs	10,000 / HOM	*10,000	---	Lugs	10,000 HOM	22,000	---	QOM2..VH	10,000 HOM	10,000	---	QOM2	10,000 HOM	<p>UL Underwriter's Laboratories, Inc.® LISTED Electric Cabinet Box Issue No. V-2813</p> <p>Install loose label with Spanish translation on back of cover. Adhiera la etiqueta suelta con las traducciones en español en la parte posterior del frente. Please read information before installing. Por favor lea la información antes de instalar.</p> <p>SQUARE D COMPANY® 001021 15 40265-381-03</p>
Wire Range (AWG/kcmil)	Torque (in.lbs.)																																														
4 - 250 CU/AL	250																																														
Service Ground Lug	50																																														
Alternate Main Breaker	See Main Breaker																																														
Wire Range (AWG)	Torque (in.lbs.)																																														
8 CU / AL	Large 45																																														
8 CU / AL	Large 40																																														
14-10 CU, 12-10 AL	Large 35																																														
Two 14 or 12 CU	25																																														
Two 12 or 10 AL	10																																														
Panel Rating	Remote Main	Integral Main	Branch (min.) Cat. prefix																																												
42,000	QOH	Main Lugs	10,000 / HOM																																												
22,000	QOME..VH	Lugs	10,000 / HOM																																												
*10,000	---	Lugs	10,000 HOM																																												
22,000	---	QOM2..VH	10,000 HOM																																												
10,000	---	QOM2	10,000 HOM																																												

Homeline Wiring Diagram Sample

<p>Service Equipment marking. Use of unused neutral branch terminal for equipment grounding, service equipment application only.</p>	<p>Installation of back-fed main circuit breaker and required kit. Alternate wiring diagram for main circuit breaker or main lug.</p>	<p>Type of circuit breakers from Square D that may be used in this panelboard.</p>	<p>Load center accessories. Neutral lug for 1/0 AWG or larger wire.</p>
<p>Suitable for use with 75°C Copper or Aluminum main conductors. See branch breakers for branch wire ratings.</p> <p>* Suitable for use as service equipment when service disconnect (main breaker) is installed. * Suitable for use as service equipment when not more than six main disconnecting means are provided and when not used as a lighting and appliance branch circuit panelboard. See Article 384-14 of the NEC. * When used as service equipment, all unused neutral terminals may be used for terminating equipment ground wires.</p>	<p>1. Box bonding when required. / Conexion a la caja cuando fuese necesario. 2. Main breaker type: QOM1 or QOM1A. / Interruptor automatico principal tipo: QOM1 o QOM1A.</p> <p>3. Service ground when required. / Tierra de acometida cuando fuese necesario</p> <p>4. Main lugs kit no: QOL125. / No. de accesorio de las zapatas principales: QOL125.</p> <p>Torque Note: When main breaker or main lug connector mounting nuts are loosened or removed, retighten to 75 lbs./in. torque.</p> <p>Equipment Grounding Terminals</p>	<p>One single pole. One plug on space. One two pole requires two plug on spaces.</p>	<p>Load Center Accessories - Kits</p> <ul style="list-style-type: none"> HOM4K2LA Back-fed Main Circuit Brkr. Retaining HOM2175SB Plug-On Surge Arrestor * SDSA1175 1 Phase Surge Arrestor QOSAMK SDSA1175 Mounting Bracket HOML2125 1 Phase Plug-on Subfeed Lugs * PK9--27GTA(L) Equipment Ground Bar PKGTAB Equipment Ground Bar Insulator LK70AN 70A Max. Neutral Lug LK100AN 125A Max. Neutral Lug QOL125 Main Lugs PK6FL Indoor Cover Lock <p>* May plug on two adjacent spaces. Torque Note: When interior mounting screw is loosened or removed, retighten to 35 lbs./in.</p> <p>SQUARE D COMPANY® Made in U.S.A. 15 40265-668-02</p>

Homeline® Circuit Breakers and Load Centers—Class 1170 Wiring Diagrams

WIRING DIAGRAMS

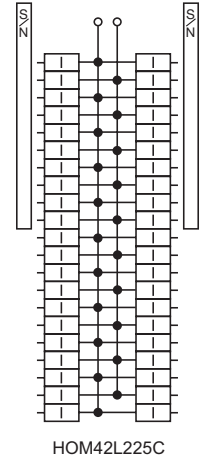
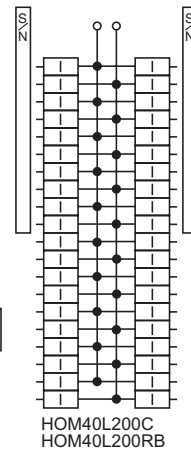
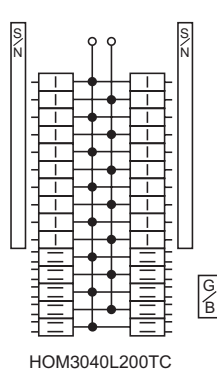
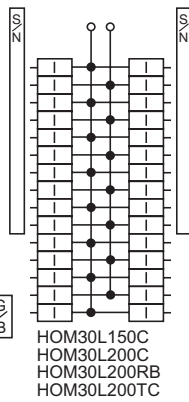
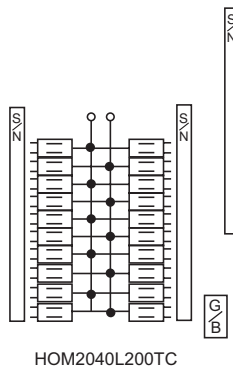
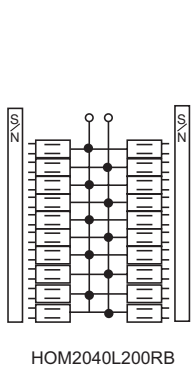
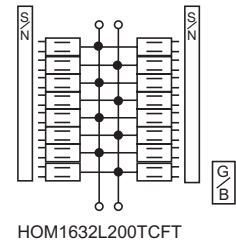
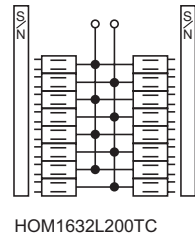
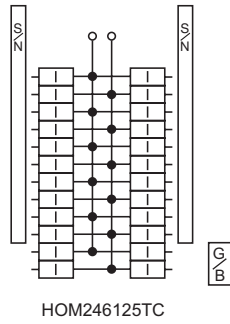
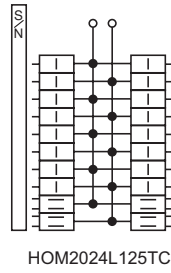
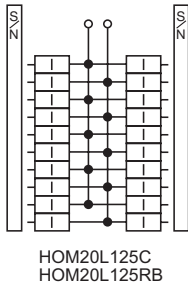
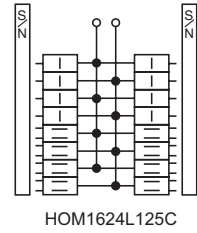
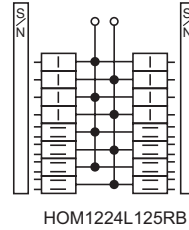
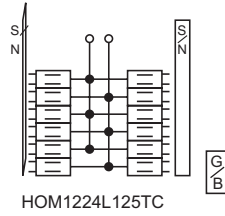
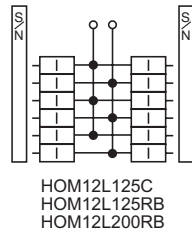
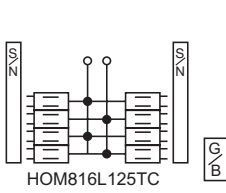
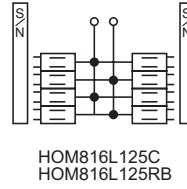
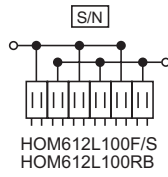
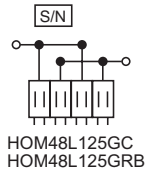
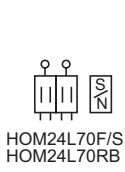

1-Phase, 3-Wire Main Lugs

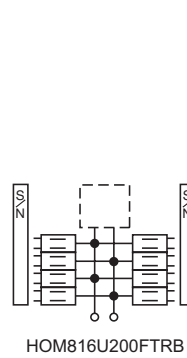
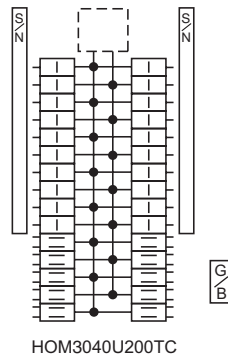
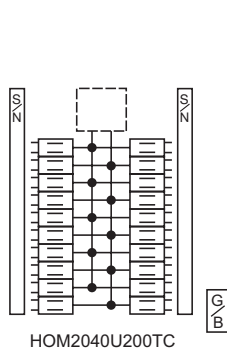
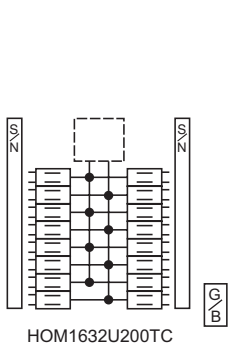

Requires Field Installed Main

Universal Mains

Homeline® Circuit Breakers and Load Centers—Class 1170 Wiring Diagrams

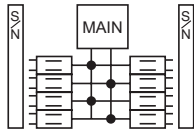

HOM816M100C
HOM816M100RB

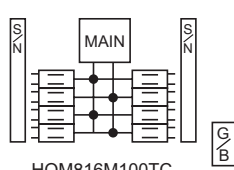

HOM816M100TC

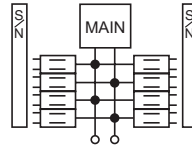

HOM816M150FTRB
HOM816M200FTRB

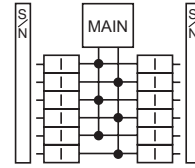

HOM12M100C
HOM12M100RB

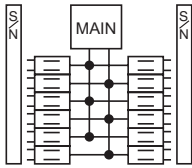

HOM1224M125C

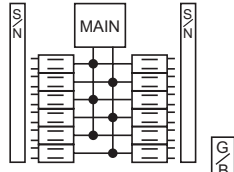

HOM1224M100TC
HOM1224M125TC
HOM1224M200TC

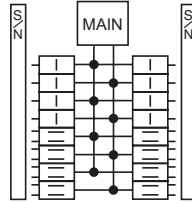

HOM1624M225RB

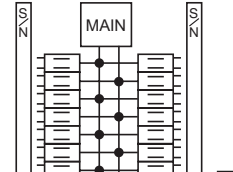

HOM1632M150TC
HOM1632M200TC

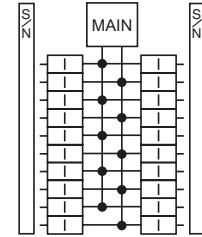

HOM20M100C
HOM20M100RB

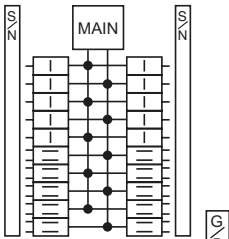

HOM2030M150TC

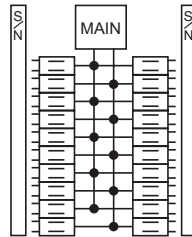

HOM2040M200C
HOM2040M200RB

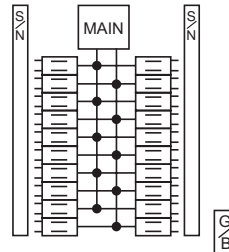

HOM2040M200TC

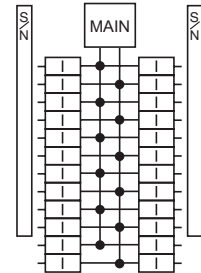

HOM24M100C
HOM24M100RB
HOM24M125C
HOM24M125RB
HOM24M200C

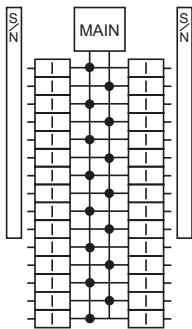

HOM30M100C
HOM30M125C
HOM30M150C
HOM30M200C
HOM30M150RB
HOM30M200RB

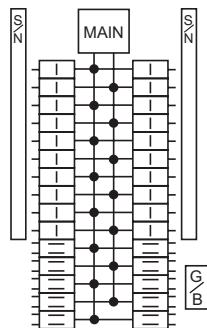

HOM3040M200TC
HOM3040M200RB

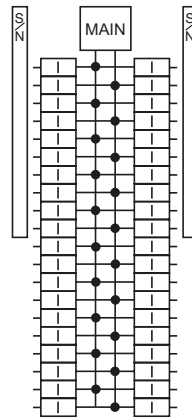

HOM40M200C
HOM40M200RB

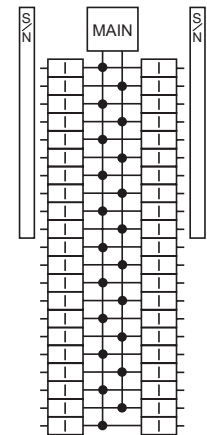

HOM42M225C
HOM42M200C
HOM42M225RB

1-Phase, 3-Wire Main Circuit Breakers

INDEX

A

accessories

- cover filler plates 16, 46
- flush lock kits 16, 47
- generator circuit breaker interlock kit 17, 47
- grounding bar kits 16, 19, 51
- manual transfer equipment kit 17
- secondary surge arrester 17, 46

assemblies

- base 35
- neutral 7, 35

auxiliary

- gutters and tap kits 18
- neutral lugs 16, 46

B

- back-fed circuit breaker retaining kit 17, 47
- base assemblies 35
- bolt-on hubs 6, 18, 35, 46
- branch circuit breakers 5, 42

C

- catalog number description 4, 41

circuit breakers

- back-fed 17, 47
- branch 5, 42
- enclosed molded case 36
- lugs 10
- main 10, 13, 44
- ratings 5, 9, 20, 34, 36, 44, 47
- with Visi-Trip® 35

class CTL 7, 42

convertible

- main circuit breakers, single-phase 9, 47
- main lugs, single-phase 10, 20, 47
- mains, single-phase 8, 15, 45
- mains, three-phase 13, 14

cover filler plates 16, 46

covers

- indoor 6, 44
- load centers 8, 10, 13, 44

CSA certified 8, 11

D

dimensions and knockouts

- indoor 26, 37
- outdoor 27, 37

E

enclosures

- type 1, indoor 6, 34, 43
- type 3R, outdoor 6, 34, 43

F

feed-thru

- lugs 11, 45, 53, 51
- universal main 45, 47

fixed

- main lugs, single-phase 8, 15, 20, 45, 47
- main lugs, three-phase 13
- mains, single-phase 10, 15, 20, 21, 45, 47, 51
- mains, three-phase 14, 24, 29

flush lock kits 16, 47

G

- generator panels 12, 25
- grounding bar kits 16, 19, 35, 46, 48

H

- hubs, bolt-on 6, 18, 35, 46, 46

I

- interiors 8, 9, 13, 15, 44

K

kits

- auxiliary gutters and taps 18
- back-fed main circuit breakers 17, 47
- flush lock 16, 47
- grounding bar 16, 19, 35, 46, 47
- main circuit breakers 10, 45, 47
- main lugs 10, 14, 47
- manual transfer 17
- retaining 17, 47

L

load centers

- Homeline® circuit breaker 42
- QO® circuit breaker 3

lugs

- auxiliary neutral 16, 46
- feed-thru 11, 26, 45, 51
- line 7
- main 7, 11, 14, 20-26, 44, 45, 47
- ratings 5, 9, 20, 44, 46

M

main circuit breakers

- features 3, 11, 12, 16, 45
- kits 10, 47
- mobile home load centers 45
- ratings 5, 9, 35, 36, 45
- sizes 12, 13, 15, 44

mains

- back-fed 17, 47
- convertible, single-phase 9, 20-24, 28, 49
- convertible, three-phase 13
- fixed, single-phase 20, 44, 49, 51
- fixed, three-phase 24, 29
- lug kits 10, 14, 47
- lugs 14, 20 2 8, 44, 46

manual transfer kits 17

N

- neutral assemblies 7, 35

R

ratings

- circuit breakers 5, 20, 34, 36, 44, 47
- enclosed molded case circuit breakers 34, 36
- grounding bar 16, 19, 35, 46, 51
- main circuit breakers 5, 13, 20, 45, 47
- indoor, single-phase 9, 10, 20, 49
- indoor, three-phase 24, 28
- rainproof, single-phase 11, 18, 46
- rainproof, three-phase 24, 25
- main lugs 5, 20-28, 44, 45
- main lugs and main circuit breakers 5, 20 2 8, 45, 47
- indoor, single-phase 9, 10, 20, 49
- indoor, three-phase 24, 25
- rainproof, single-phase 11, 12, 20, 47, 51
- rainproof, three-phase 24, 25
- recreational vehicle and manufactured housing 11
- short circuit 8, 9, 13, 15, 20-25, 44, 47
- tap kits 18

RB devices 6, 18, 34, 46

recreational vehicle and manufactured housing 11

replacement parts - see note below retaining kits 17, 47

S

- service 5, 34, 42
- short circuit ratings 9, 13, 15, 20-25, 44, 49
- special purpose 11 12
- surge arresters, secondary 17, 46

T

- transfer switches, manual and automatic 12

U

- UL listed 8 9, 13, 15, 17, 18, 20-26, 36, 42, 46, 49

W

- wiring diagrams 30 33, 53

NOTE: For information on Replacement Parts with specific part numbers, go to www.schneider-electric.us, click on Product FAQ's, enter the device catalog number, click SEARCH, then look for the information required.

**QO® and Homeline® Circuit Breaker Load Centers and Enclosures
Catalog**

Schneider Electric USA

1601 Mercer Road
Lexington, KY 40511 USA
1-888-SquareD
(1-888-778-2733)
www.us.SquareD.com

Electrical equipment should be installed, operated, serviced, and maintained only by qualified personnel. No responsibility is assumed by Schneider Electric for any consequences arising out of the use of this material.

1100CT0501 © 2007 Schneider Electric All Rights Reserved
Replaces 1100CT9901 dated September 2000.

X-ON Electronics

Largest Supplier of Electrical and Electronic Components

Click to view similar products for [schneider](#) manufacturer:

Other Similar products are found below :

[LU9M1](#) [7D](#) [7S](#) [7XA1](#) [FNQR2](#) [8501RS44V24](#) [8501RSD14P14V51](#) [8501XO20V03Y414](#) [9001KXRK](#) [9001SKR9P35RH25](#) [9001SKT35L31](#)
[9003K2C003GA](#) [9007AA1](#) [9007BA1](#) [9007C54D](#) [9007C62A2](#) [9007CA11](#) [9007FA3](#) [9007HA4](#) [9007HA6](#) [9007KA1](#) [9007KB11](#)
[9007MS01S0206](#) [9007MS02S0300](#) [9012GAR4](#) [9012GAW2](#) [9012GBW1](#) [9012GDW5E3](#) [9012GFW1](#) [9012GNG1](#) [9012GNG3](#) [9012GNG6](#)
[9013FHG39J69](#) [9013GHG2J30](#) [9050JCK2F30V14](#) [GV2ME32](#) [GVAN20](#) [GZ1E02](#) [A9F04102](#) [A9F04106](#) [A9F05110](#) [A9F07102](#)
[ABL8RPS24030](#) [DL1BLB](#) [ATS01N206QN](#) [RSL1PRJU](#) [9001KA35](#) [9001KA3G](#) [9001KA4](#) [9001KR1GH5](#)