



US Catalog

Motor protection and control AF Range contactors & overload relays

Power and productivity
for a better world™



Motor rated operational powers and currents

The currents given below concern standard three-phase four-pole cage motors (1500 r.p.m. at 50 Hz 1800 r.p.m. at 60 Hz). These values are given for guidance and may vary according to the motor manufacturer and depending on the number of poles.

IEC Motor power kW	Motor nominal current: standardized values in blue colour (according to IEC 60947-4-1 Annex G)									
	220 V A	230 V A	240 V A	380 V A	400 V A	415 V A	440 V A	500 V A	660 V A	690 V A
0.06	0.37	0.35	0.34	0.21	0.2	0.19	0.18	0.16	0.13	0.12
0.09	0.54	0.52	0.50	0.32	0.3	0.29	0.26	0.24	0.18	0.17
0.12	0.73	0.7	0.67	0.46	0.44	0.42	0.39	0.32	0.24	0.23
0.18	1	1	1	0.63	0.6	0.58	0.53	0.48	0.37	0.35
0.25	1.6	1.5	1.4	0.9	0.85	0.82	0.74	0.68	0.51	0.49
0.37	2.0	1.9	1.8	1.2	1.1	1.1	1	0.88	0.67	0.64
0.55	2.7	2.6	2.5	1.6	1.5	1.4	1.3	1.2	0.91	0.87
0.75	3.5	3.3	3.2	2.0	1.9	1.8	1.7	1.5	1.15	1.1
1.1	4.9	4.7	4.5	2.8	2.7	2.6	2.4	2.2	1.7	1.6
1.5	6.6	6.3	6	3.8	3.6	3.5	3.2	2.9	2.2	2.1
2.2	8.9	8.5	8.1	5.2	4.9	4.7	4.3	3.9	2.9	2.8
3	11.8	11.3	10.8	6.8	6.5	6.3	5.7	5.2	4	3.8
4	15.7	15	14.4	8.9	8.5	8.2	7.4	6.8	5.1	4.9
5.5	20.9	20	19.2	12.1	11.5	11.1	10.1	9.2	7	6.7
7.5	28.2	27	25.9	16.3	15.5	14.9	13.6	12.4	9.3	8.9
11	39.7	38	36.4	23.2	22	21.2	19.3	17.6	13.4	12.8
15	53.3	51	48.9	30.5	29	28	25.4	23	17.8	17
18.5	63.8	61	58.5	36.8	35	33.7	30.7	28	22	21
22	75.3	72	69	43.2	41	39.5	35.9	33	25.1	24
30	100	96	92	57.9	55	53	48.2	44	33.5	32
37	120	115	110	69	66	64	58	53	40.8	39
45	146	140	134	84	80	77	70	64	49.1	47
55	177	169	162	102	97	93	85	78	59.6	57
75	240	230	220	139	132	127	116	106	81	77
90	291	278	266	168	160	154	140	128	97	93
110	355	340	326	205	195	188	171	156	118	113
132	418	400	383	242	230	222	202	184	140	134
160	509	487	467	295	280	270	245	224	169	162
200	637	609	584	368	350	337	307	280	212	203
250	782	748	717	453	430	414	377	344	261	250
315	983	940	901	568	540	520	473	432	327	313
355	1109	1061	1017	642	610	588	535	488	370	354
400	1255	1200	1150	726	690	665	605	552	418	400
500	1545	1478	1416	895	850	819	745	680	515	493
560	1727	1652	1583	1000	950	916	832	760	576	551
630	1928	1844	1767	1116	1060	1022	929	848	643	615
710	2164	2070	1984	1253	1190	1147	1043	952	721	690
800	2446	2340	2243	1417	1346	1297	1179	1076	815	780
900	2760	2640	2530	1598	1518	1463	1330	1214	920	880
1000	3042	2910	2789	1761	1673	1613	1466	1339	1014	970

UL/CSA Motor power hp	Motor nominal current: single and three phase (according to UL 60947-4-1A)									
	120 V 1-ph A	200 V 1-ph A	200 V 3-ph A	208 V 1-ph A	208 V 3-ph A	220- 240 V 1-ph A	220- 240 V 3-ph A	380- 415 V 3-ph A	440- 480 V 3-ph A	550- 600 V 3-ph A
1/10	3	-	-	-	-	1.5	-	-	-	-
1/8	3.8	-	-	-	-	1.9	-	-	-	-
1/6	4.4	2.5	-	2.4	-	2.2	-	-	-	-
1/4	5.8	3.3	-	3.2	-	2.9	-	-	-	-
1/3	7.2	4.1	-	4	-	3.6	-	-	-	-
1/2	9.8	5.6	2.5	5.4	2.4	4.9	2.2	1.3	1.1	0.9
3/4	13.8	7.9	3.7	7.6	3.5	6.9	3.2	1.8	1.6	1.3
1	16	9.2	4.8	8.8	4.6	8	4.2	2.3	2.1	1.7
1-1/2	20	11.5	6.9	11	6.6	10	6	3.3	3	2.4
2	24	13.8	7.8	13.2	7.5	12	6.8	4.3	3.4	2.7
3	34	19.6	11	18.7	10.6	17	9.6	6.1	4.8	3.9
5	56	32.2	17.5	30.8	16.7	28	15.2	9.7	7.6	6.1
7-1/2	80	46	25.3	44	24.2	40	22	14	11	9
10	100	57.5	32.2	55	30.8	50	28	18	14	11
15	135	-	48.3	-	46.2	68	42	27	21	17
20	-	-	62.1	-	59.4	88	54	34	27	22
25	-	-	78.2	-	74.8	110	68	44	34	27
30	-	-	92	-	88	136	80	51	40	32
40	-	-	120	-	114	176	104	66	52	41
50	-	-	150	-	143	216	130	83	65	52
60	-	-	177	-	169	-	154	103	77	62
75	-	-	221	-	211	-	192	128	96	77
100	-	-	285	-	273	-	248	165	124	99
125	-	-	359	-	343	-	312	208	156	125
150	-	-	414	-	396	-	360	240	180	144
200	-	-	552	-	528	-	480	320	240	192
250	-	-	-	-	-	-	604	403	302	242
300	-	-	-	-	-	-	722	482	361	289
350	-	-	-	-	-	-	828	560	414	336
400	-	-	-	-	-	-	954	636	477	382
450	-	-	-	-	-	-	1030	-	515	412
500	-	-	-	-	-	-	1180	786	590	472

Motor protection and control

AF Range contactors and overload relays

[Overview](#)

1

[AF Range contactors and control relays](#)

2

[Overload relays](#)

3

[General technical data](#)

4

[Catalog number alphanumeric](#)

5

ABB sets a new standard in motor control and power switching

1

Featuring AF technology as standard, the latest range of ABB's contactors establishes a new industry benchmark. The electronically controlled coil offers multiple benefits over conventional alternatives, and together with ABB's wide product offering – an optimal configuration, every time.



Access Global Support

The contactor and motor protection range from ABB is compatible with all major national and international standards and is available worldwide via a global distribution network. One contactor coil now handles 100 V – 250 V, AC/DC for use in Europe or Asia as well as North America.



Optimize logistics

With its contactor and motor protection range, ABB has managed to reduce the number of contactor coils to just four. The total number of product variants has been reduced by up to 90%. This simplifies the customers' logistics and cuts administration costs.



Simplify design

By reducing contactor coil energy consumption by up to 80%, panels can be built smaller and transformers more compact. All the features of the AF technology, along with access to drawings and coordination tables online, simplifies your design and assembly process.



Secure uptime

Time to prevent stoppages caused by voltage fluctuations. The AF contactor ensures distinct operation in unstable networks and signifies a major advance in motor control and power switching. Voltage sags, dips and surges pose no threat. The AF contactor secures your uptime.



MacGregor. Keeping turnarounds brief.

Until the AF range was installed, voltage sags were affecting MacGregor's deck cranes. Conventional contactors welded shut, leading to several stoppages a week. No longer. Known for superior quality and an ability to operate in the most hostile environments, MacGregor deck cranes enjoy a global reputation for reliability. A small but vital component, the AF contactor helps maintain this reputation.

To keep things moving, you need Control. Connect to Control.

Explore all our case studies at www.abb.com/connecttocontrol

SSAB
Making certainty
standard

Gamesa
Taming the wind

LKAB
Providing fresh air

Contactors and motor protection

For a wide variety of segments

1

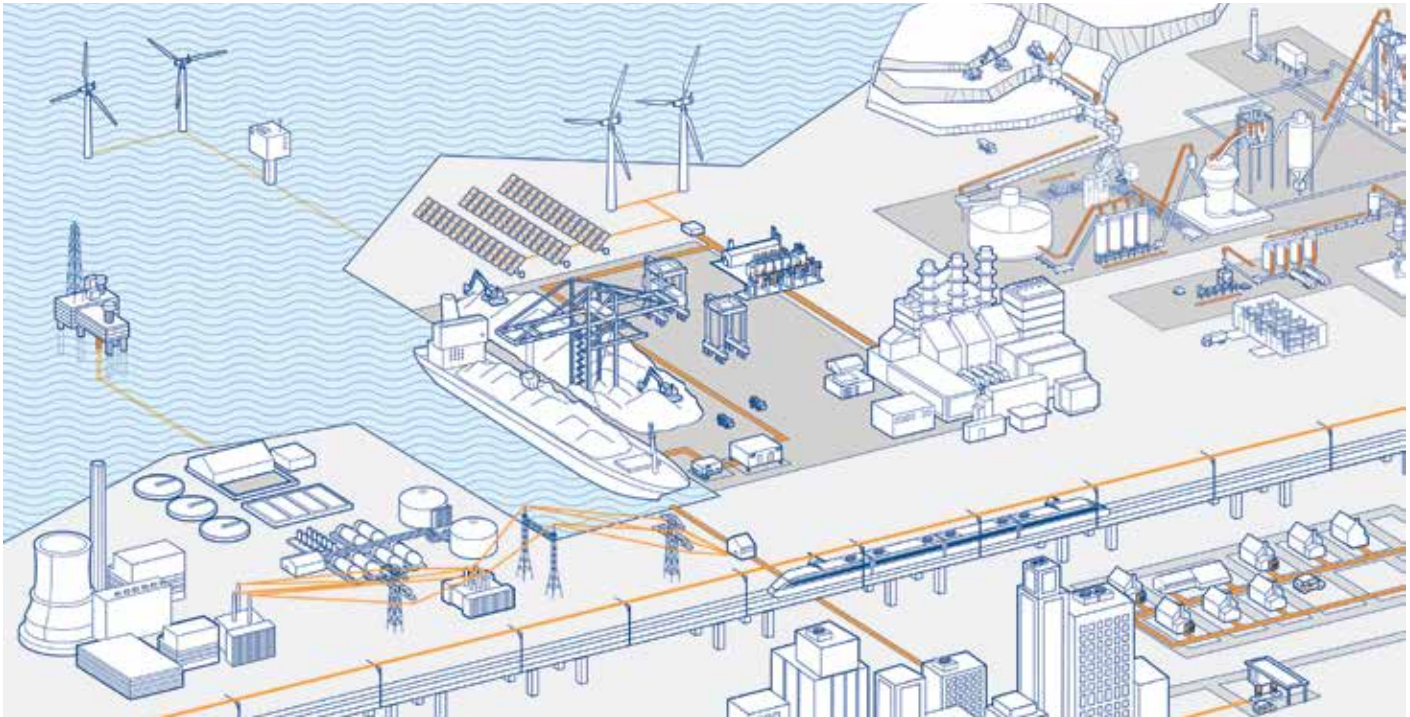

HVAC, General Machinery, Rail, Critical Power, Wind, Solar, Marine and Water & Wastewater

Contactors for any use

The AF contactor range covers small motor starting solutions from 4 kW / 5 hp up to big power switching solutions with our unique AF2650, the biggest single case block contactor in the world.

The contactor and motor protection range is part of one of the widest product offerings on the market meaning that ABB not only can provide the contactor but the full solution.

In addition to the standard product range ABB also offer products for special needs such as Bar contactors, GAF and contactors for capacitor switching.

Cooperating with customers

ABB cooperates closely with its customers to ensure that products meet requirements from their specific segments and applications. With over 100 years' experience in motor control and power switching ABB knows how to create efficient solutions for its customers.

AF technology

Benefits



Reliable in all networks

The electronic system within the AF contactor rectifies the AC or DC control circuit voltage to a DC control voltage that is applied on the coil. The contactor is safely operated in an always optimized condition making it virtually noise free.

Four coils for the entire voltage range

The AF contactor features both AC and DC support. With the complete AF contactor range, functionality is improved. Still, the total number of product variants compared to a conventional range is reduced by 90%. Only four coils are required to cover 24 V AC, 20 V DC - 500 V AC/DC.

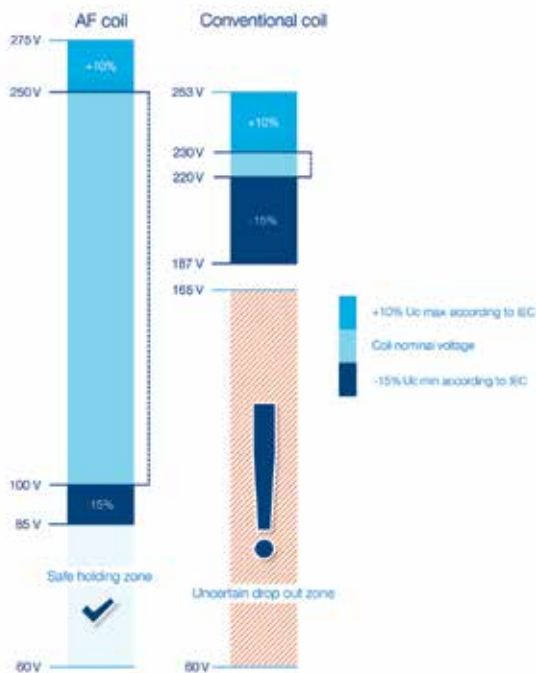

Wide control voltage range

With conventional contactor technology, different contactors were needed for different network voltages. Thanks to the wide operating range of the AF contactor it can operate just as well in Europe as in Asia or North America. The core coil of the AF contactor range covers 100-250 V AC/DC 50/60 Hz.

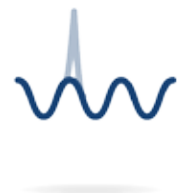

Built-in surge suppression

With conventional contactor technology it is recommended to use an external surge suppressor, an accessory that could cost as much as half the contactor itself. With the AF technology the surges are handled by the contactor itself and the surge never reaches the control circuit. Neither the surge suppressor nor the actual surge has to be considered anymore. One less product and one less complication to worry about.

Contactors and motor protection

Advanced but simple

1

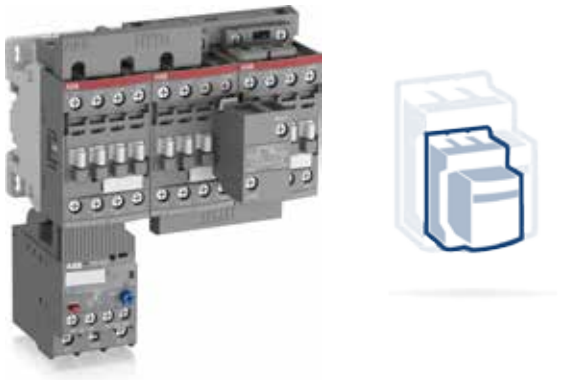

The AF contactor is compact

The AF contactor is compact in size and has had its width reduced by up to 30% thanks to an 80% reduction of the coil's energy consumption.



The AF contactor is flexible

AF09...AF370 is perfect for motor starting applications and for solutions where space is limited. Interlocked reversing pairs require no spacing between contactors meaning you can fit more functionality into cabinets or other small enclosures.



Coil terminal access in the front

The AF contactor has its coil terminals accessible from the front. The cables or bars do not have to be disconnected in order to perform voltage measurement or servicing work.



More functionality without adding width

The AF116 ... AF2650 can take up to 2 side mounted auxiliary contact blocks without adding to its width and are delivered with 1 N.O. + 1 N.C. as standard.

Contactors and motor protection

Mechanical features

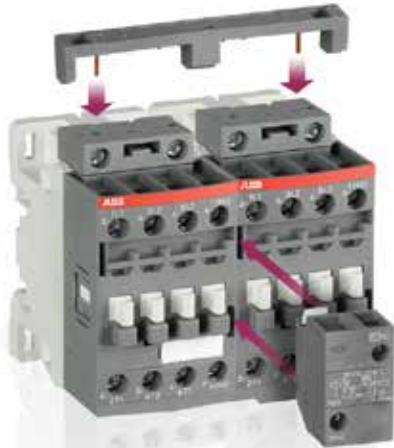

Front-mounted

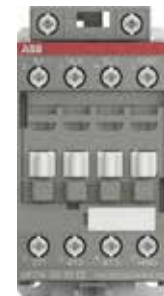

Top-mounted



Bottom-mounted



Additional LDC4 coil terminal block

Easy-to-use accessories

Contactors up to 96 A offer free choice of coil terminal access and can take side and front mounted auxiliary contact blocks. All the accessories: Coil connection terminals, mechanical and electrical interlocks and electronic timers are easily connected through the snap-to-connect function.



Safe control circuit with:

- Mirror contact according to IEC 60947-4-1
- Mechanically linked contacts according to IEC 60947-5-1
- Sealable and transparent protective covers on AF09...AF96 and overload relays TF/EF
- Third party certification:
 - AF09...AF96, NF
 - AF400...AF2050





Connect to Control

ABB is introducing its complete AF contactor range. The AF technology is well appreciated by customers and establishes a new industry benchmark. ABB sets a new standard in motor control and power switching. Watch the video above or read how our customers experience the AF technology.



Case studies

Instead of telling our customers about the AF contactor – we asked them. They are the ones using the products everyday and therefore they should have the most interesting stories.

→ Read more



Value propositions

Choose AF contactors and ABB to secure uptime, simplify design, optimize logistics and gain access to global support. Watch videos and read why AF contactors are the right choice.

→ Read more



Product tour

Read more about the technical details of the AF contactor and the technology. What has made it so appreciated by customers?

→ Read more

Sitemap

- Connect to Control
- Case studies
- Value propositions
- Product tour
- History
- News

Contact us

Sales → Low Voltage Products and Systems

Downloads

- Product panoramas (1 mb)
- Promotion video (360p, 15 mb)
- Promotion video (720p, 25 mb)
- Promotion video (1080p, 104 mb)
- Main catalog (94 mb)
- Short-form catalog (50 mb)

Follow us



Links

- Low Voltage Products
- SOC II
- Cadexes

Share this

- Open Facebook share
- Open Tweet box

3-pole contactors, for motor control and power switching

1



AC / DC Control supply				Type	AF09	AF12	AF16	AF26	AF30	AF38	AF40	AF52	AF65	AF80	AF96	
IEC	AC-3	Rated operational power	220 - 230 - 240 V	kW	2.2	3	4	6.5	9	11	11	15	18.5	22	25	
			380 - 400 V	kW	4	5.5	7.5	11	15	18.5	18.5	22	30	37	45	
	AF370		415 V	kW	4	5.5	9	11	15	18.5	22	30	37	45	55	
			440 V	kW	4	5.5	9	15	18.5	22	22	30	37	45	55	
	AF2650		500 V	kW	5.5	7.5	9	15	18.5	22	22	30	37	45	55	
			690 V	kW	5.5	7.5	9	15	18.5	22	22	30	37	45	55	
		1000 V	kW	—	—	—	—	—	—	—	—	—	—	—		
		Rated operational current	380 - 400 V	A	9	12	18	26	32	38	40	53	65	80	96	
AC-1		Rated operational current	$\theta \leq 40^\circ\text{C}$, 690 V	A	25	28	30	45	50	50	70	100	105	125	130	
UL / CSA	1-phase motor rating		120 V	hp	0.75	1	1.5	2	2	2	3	3	5	7.5	7.5	
			240 V	hp	1.5	2	3	3	5	5	7.5	10	15	15	20	
	3-phase motor rating		200 - 208 V	hp	2	3	5	7.5	10	10	10	15	20	25	30	30
			220 - 240 V	hp	2	3	5	7.5	10	10	15	20	25	30	30	
			440 - 480 V	hp	5	7.5	10	15	20	20	30	40	50	60	60	
		550 - 600 V	hp	7.5	10	15	20	25	25	40	50	60	75	75		
	General use rating		600 V	A	25	28	30	45	50	50	60	80	90	105	115	
NEMA		NEMA Size			00	0	—	1	—	—	2	—	—	3	—	

Main accessories

Auxiliary contact blocks	Front mounting	CA4-10 (1 x N.O.) CA4-01 (1 x N.C.)
	Side mounting	CAL4-11 (1 x N.O. + 1 x N.C.)
Timers	Electronic	TEF4-ON
		TEF4-OFF
Interlocking units	Mechanical	VM4
	Mechanical / Electrical	VEM4
Connection sets	For reversing contactors	BER16-4
Surge suppressors		Built-in surge protection

Overload relays

Thermal relays		Class 10 (Class 10A for TF140, TA200DU)	TF42 (0.10...38 A)	TF65 (22...67 A)	TF96 (40...96 A)
Electronic relays		Class 10E, 20E, 30E	EF19 (0.10...18.9 A)	EF19 (0.10...18.9 A) EF45 (9...45 A)	EF65 (25...70 A) EF96 (36...100 A)

Manual motor starters

	Thermal / magnetic protection Class 10	MS116 (0.10...32 A) SCCR up to 30 kA	MS450 (28...50 A) SCCR up to 65 kA
		MS132 (0.10...32 A) SCCR up to 65 kA	MS495 (45...100 A) SCCR up to 65 kA
	Magnetic only types	MO132 (0.16...32 A) SCCR up to 65 kA	MO496 (32...100 A) SCCR up to 65 kA
			MO450 (40...50 A) SCCR up to 65 kA
			MO495 (63...100 A) SCCR up to 65 kA
Accessories	For contactor mounting	BEA16-4	BEA38-4



AF116	AF140	AF146	AF190	AF205	AF265	AF305	AF370	AF400	AF460	AF580	AF750	AF1250	AF1350	AF1650	AF2050	AF2650
30	37	45	55	55	75	90	110	110	132	160	220	—	257	315	—	—
55	75	75	90	110	132	160	200	200	250	315	400	—	475	560	—	—
55	75	75	90	110	132	160	200	220	250	355	425	—	500	600	—	—
75	90	90	110	132	160	160	200	220	250	355	450	—	560	670	—	—
75	90	90	110	132	160	200	250	250	315	400	520	—	560	700	—	—
55	75	90	132	160	200	250	315	315	355	500	600	—	750	900	—	—
—	—	75	110	132	132	132	132	220	280	355	400	—	—	—	—	—
116	140	146	190	205	265	305	370	400	460	580	750	—	860	1050	—	—
160	200	225	275	350	400	500	600	600	700	800	1050	1260	1350	1650	2050	2650
—	—	—	—	—	—	—	—	—	—	—	—	—	—	—	—	—
—	—	—	—	—	—	—	—	—	—	—	—	—	—	—	—	—
30	40	40	50	60	75	100	125	125	150	200	250	—	—	—	—	—
40	50	50	60	75	100	125	150	150	200	250	300	—	400	450	—	—
75	100	100	125	150	200	250	300	350	400	500	600	—	800	900	—	—
100	125	125	150	200	250	300	350	400	500	600	700	—	1000	1150	—	—
160	200	200	230 (1)	250 (1)	300 (1)	350 (1)	400 (1)	550	650	750	900	1210	1350	1650	2100	2700
—	4	—	—	—	5	—	—	—	6	—	7	—	—	8	—	—

(1) Higher ratings achievable through the use of LX.. terminal extensions. See page 2.6 for additional information.

CAL19-11 (1 x N.O. + 1 x N.C.) CAL18-11 (1 x N.O. + 1 x N.C.)

VM19 (for same size contactors) VM750H VM750V VM1650H

BER140-4 BER205-4 BER370-4 BEM460-30 BEM750-30

TF140DU (66...142 A) θ ≤ 55 °C	TA200DU (66...200 A) θ ≤ 55 °C	EF370 (115...380 A)	E500DU (150...500 A)	E800DU (250...800 A)	E1250DU (375...1250 A)
EF146 (54...150 A)	EF205 (63...210 A)				

Short-circuit protection devices

Tmax circuit breakers & OS Fusible disconnect switches



4-pole contactors

1

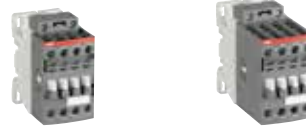

IEC	AC-1 Rated operational current	$\theta \leq 40\text{ }^\circ\text{C}$, 690 V	A	25	30	45	55	
UL/CSA	General use rating	600 V	A	25	30	45	55	
AC / DC Control supply				Type	AF09	AF16	AF26	AF38
IEC	AC-1 Rated operational current	$\theta \leq 40\text{ }^\circ\text{C}$	A	25	30	45	55	
		$\theta \leq 55\text{ }^\circ\text{C}$ (1)	A	25	30	40	45	
		$\theta \leq 70\text{ }^\circ\text{C}$	A	22	26	32	37	
With conductor cross sectional area			mm ²	4	6	10	16	
Rated operational voltage U _e max.			V	690	690	690	690	
UL/CSA	General use rating	600 V	A	25	30	45	55	

(1) $\theta \leq 60\text{ }^\circ\text{C}$ for AF09 ... AF38 contactors

Main accessories

Auxiliary contact blocks	Front mounting	CA4-10 (1 x N.O.), CA4-01 (1 x N.C.)
	Side mounting	CAL4-11 (1 x N.O. + 1 x N.C.)
Timers	Electronic	TEF4-ON
		TEF4-OFF
Interlocking units	Mechanical	VM4
	Mechanical / Electrical	VEM4
Surge suppressors	Varistor (AC / DC)	Built-in surge protection
	RC Type (AC)	
	Transil diode (DC)	

AF Range contactors and control relays

Table of contents

Selection pages

3-pole contactors	2.2 - 2.8
3-pole reversing contactors.....	2.9 - 2.14
3-pole NEMA rated contactors	2.15 - 2.20
3-pole NEMA rated reversing contactors.....	2.21 - 2.25
4-pole contactors	2.26 - 2.27
Control relays	2.28 - 2.31
Voltage code table.....	2.32 - 2.33

Accessories

Accessory fitting details	2.34 - 2.40
Auxiliary contact blocks	2.41 - 2.45
Electronic timers.....	2.46
Interlocks	2.47
Mechanical latching units	2.48
Other accessories.....	2.49 - 2.50
Terminal shrouds and mechanical lugs.....	2.51
Terminal enlargements and extensions.....	2.52
Terminal connecting strips and shorting bars.....	2.53
Reversing and phase-to-phase bus kits	2.54
Wye-delta bus kits	2.55
Coupling units	2.56 - 2.57
Mounting and adaptor plates.....	2.58 - 2.59
Service parts	2.60

Technical data

3-pole contactors	2.61 - 2.77
4-pole contactors	2.78 - 2.81
Control relays	2.82 - 2.84
Auxiliary contact blocks	2.85 - 2.88
Electronic timers.....	2.89 - 2.90
Interlocks	2.91
Mechanical latching units	2.92

Terminal marking and positioning

3-pole contactors	2.93 - 2.95
4-pole contactors	2.96
Control relays	2.97
Add-on auxiliary contacts.....	2.98

AF09 ... AF38 3-pole contactors

5 to 20 hp at 480 V AC

AC / DC operated

2



AF09-30-10



AF26-30-00

Description

AF09 ... AF38 contactors are mainly used for controlling 3-phase motors and power circuits up to 690 V AC and 220 V DC. These contactors are of the block type design with 3 main poles.

- control circuit: AC or DC operated with electronic coil interface accepting a wide control voltage range (e.g. 100...250 V AC and DC), only 4 control voltage ranges covering 24...500V 50/60 Hz and 20...500 V DC
- can manage large control voltage variations
- reduced panel energy consumption
- very distinct closing and opening.
- built-in surge suppression
- add-on auxiliary contact blocks for front or side mounting and a wide range of accessories.

Ordering details

IEC		UL/CSA		Rated control circuit voltage		Auxiliary contacts fitted	Catalog number	Global reference code	Weight	
Rated operational power	current $\theta \leq 40^\circ\text{C}$	3-phase motor rating	General use rating	Uc min. ... Uc max.						Pkg (1 pce)
400 V AC-3	AC-1	480 V	600 V AC	V 50/60 Hz	V DC				kg	
4	25	5	25	24...60	-	(1)	1 0	AF09-30-10-41	1SBL137001R4110	0.270
							0 1	AF09-30-01-41	1SBL137001R4101	0.270
				48...130	48...130	1 0	AF09-30-10-12	1SBL137001R1210	0.270	
						0 1	AF09-30-01-12	1SBL137001R1201	0.270	
						1 0	AF09-30-10-13	1SBL137001R1310	0.270	
						0 1	AF09-30-01-13	1SBL137001R1301	0.270	
				100...250	100...250	1 0	AF09-30-10-14	1SBL137001R1410	0.310	
						0 1	AF09-30-01-14	1SBL137001R1401	0.310	
						1 0	AF12-30-10-41	1SBL157001R4110	0.270	
						0 1	AF12-30-01-41	1SBL157001R4101	0.270	
5.5	28	7.5	28	24...60	-	(1)	1 0	AF12-30-10-41	1SBL157001R4110	0.270
							0 1	AF12-30-01-41	1SBL157001R4101	0.270
				48...130	48...130	1 0	AF12-30-10-12	1SBL157001R1210	0.270	
						0 1	AF12-30-01-12	1SBL157001R1201	0.270	
						1 0	AF12-30-10-13	1SBL157001R1310	0.270	
						0 1	AF12-30-01-13	1SBL157001R1301	0.270	
				100...250	100...250	1 0	AF12-30-10-14	1SBL157001R1410	0.310	
						0 1	AF12-30-01-14	1SBL157001R1401	0.310	
						1 0	AF16-30-10-41	1SBL177001R4110	0.270	
						0 1	AF16-30-01-41	1SBL177001R4101	0.270	
48...130	48...130	1 0	AF16-30-10-12	1SBL177001R1210	0.270					
		0 1	AF16-30-01-12	1SBL177001R1201	0.270					
		1 0	AF16-30-10-13	1SBL177001R1310	0.270					
		0 1	AF16-30-01-13	1SBL177001R1301	0.270					
250...500	250...500	1 0	AF16-30-10-14	1SBL177001R1410	0.310					
		0 1	AF16-30-01-14	1SBL177001R1401	0.310					
		1 0	AF16-30-10-41	1SBL177001R4110	0.270					
		0 1	AF16-30-01-41	1SBL177001R4101	0.270					
7.5	30	10	30	24...60	-	(1)	1 0	AF16-30-10-41	1SBL177001R4110	0.270
							0 1	AF16-30-01-41	1SBL177001R4101	0.270
				48...130	48...130	1 0	AF16-30-10-12	1SBL177001R1210	0.270	
						0 1	AF16-30-01-12	1SBL177001R1201	0.270	
						1 0	AF16-30-10-13	1SBL177001R1310	0.270	
						0 1	AF16-30-01-13	1SBL177001R1301	0.270	
				250...500	250...500	1 0	AF16-30-10-14	1SBL177001R1410	0.310	
						0 1	AF16-30-01-14	1SBL177001R1401	0.310	
						1 0	AF26-30-00-41	1SBL237001R4100	0.310	
						0 0	AF26-30-00-12	1SBL237001R1200	0.310	
100...250	100...250	0 0	AF26-30-00-13	1SBL237001R1300	0.310					
		0 0	AF26-30-00-14	1SBL237001R1400	0.350					
		0 0	AF30-30-00-41	1SBL277001R4100	0.310					
		0 0	AF30-30-00-12	1SBL277001R1200	0.310					
100...250	100...250	0 0	AF30-30-00-13	1SBL277001R1300	0.310					
		0 0	AF30-30-00-14	1SBL277001R1400	0.350					
		0 0	AF38-30-00-41	1SBL297001R4100	0.310					
		0 0	AF38-30-00-12	1SBL297001R1200	0.310					
100...250	100...250	0 0	AF38-30-00-13	1SBL297001R1300	0.310					
		0 0	AF38-30-00-14	1SBL297001R1400	0.350					

(1) For 24...60 V 50/60 Hz - 20...60 V DC, use AF..-30-..-11 (see voltage code table). AF..-30-..-11 not suitable for direct control by PLC-output.

Main dimensions mm, inches

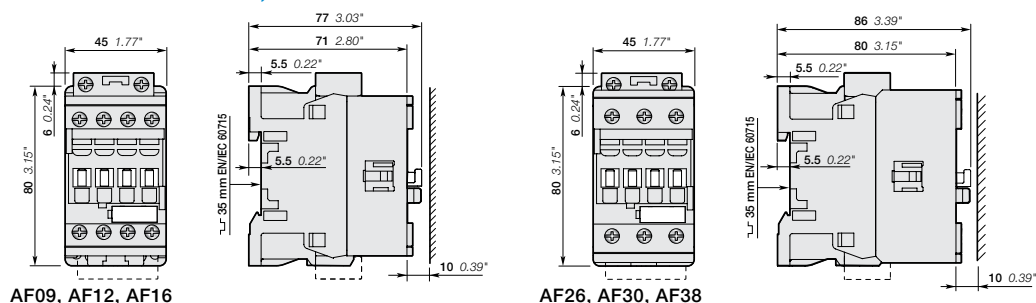

AF09Z ... AF38Z 3-pole contactors

5 to 20 hp at 480 V AC

AC / DC operated - low consumption



AF09Z-30-10



AF26Z-30-00

Description

AF09Z ... AF38Z contactors are mainly used for controlling 3-phase motors and power circuits up to 690 V AC and 220 V DC. These contactors are of the block type design with 3 main poles.

- control circuit: AC or DC operated with electronic coil interface accepting a wide control voltage range (e.g. 100...250 V AC and DC), only 4 control voltage ranges covering 24...250 V 50/60 Hz and 12...250 V DC
- can manage large control voltage variations
- allow direct control by PLC-output ≥ 24 V DC 500 mA
- reduced panel energy consumption
- very distinct closing and opening
- can withstand short voltage dips and voltage sags (SEMI F47-0706 conditions of use on request).
- built-in surge suppression
- add-on auxiliary contact blocks for front or side mounting and a wide range of accessories.

Ordering details

IEC Rated operational power	UL/CSA 3-phase motor rating 480 V	General use rating 600 V AC	Rated control circuit voltage Uc min. ... Uc max. (1)		Auxiliary contacts fitted	Catalog number	Global reference code	Weight Pkg (1 pce) kg										
			V 50/60 Hz	V DC														
400 V AC-3 kW	AC-1 A	hp	A	V 50/60 Hz	V DC													
									4	25	5	25	-	12...20	1 0	AF09Z-30-10-20	1SBL136001R2010	0.310
													24...60	20...60	0 1	AF09Z-30-01-20	1SBL136001R2001	0.310
															1 0	AF09Z-30-10-21	1SBL136001R2110	0.310
															0 1	AF09Z-30-01-21	1SBL136001R2101	0.310
													48...130	48...130	1 0	AF09Z-30-10-22	1SBL136001R2210	0.310
															0 1	AF09Z-30-01-22	1SBL136001R2201	0.310
													100...250	100...250	1 0	AF09Z-30-10-23	1SBL136001R2310	0.310
															0 1	AF09Z-30-01-23	1SBL136001R2301	0.310
													-	12...20	1 0	AF12Z-30-10-20	1SBL156001R2010	0.310
															0 1	AF12Z-30-01-20	1SBL156001R2001	0.310
													24...60	20...60	1 0	AF12Z-30-10-21	1SBL156001R2110	0.310
						0 1	AF12Z-30-01-21	1SBL156001R2101	0.310									
				48...130	48...130	1 0	AF12Z-30-10-22	1SBL156001R2210	0.310									
						0 1	AF12Z-30-01-22	1SBL156001R2201	0.310									
				100...250	100...250	1 0	AF12Z-30-10-23	1SBL156001R2310	0.310									
						0 1	AF12Z-30-01-23	1SBL156001R2301	0.310									
				-	12...20	1 0	AF16Z-30-10-20	1SBL176001R2010	0.310									
						0 1	AF16Z-30-01-20	1SBL176001R2001	0.310									
				24...60	20...60	1 0	AF16Z-30-10-21	1SBL176001R2110	0.310									
						0 1	AF16Z-30-01-21	1SBL176001R2101	0.310									
				48...130	48...130	1 0	AF16Z-30-10-22	1SBL176001R2210	0.310									
						0 1	AF16Z-30-01-22	1SBL176001R2201	0.310									
				100...250	100...250	1 0	AF16Z-30-10-23	1SBL176001R2310	0.310									
						0 1	AF16Z-30-01-23	1SBL176001R2301	0.310									
				-	12...20	0 0	AF26Z-30-00-20	1SBL236001R2000	0.350									
				24...60	20...60	0 0	AF26Z-30-00-21	1SBL236001R2100	0.350									
				48...130	48...130	0 0	AF26Z-30-00-22	1SBL236001R2200	0.350									
				100...250	100...250	0 0	AF26Z-30-00-23	1SBL236001R2300	0.350									
				-	12...20	0 0	AF30Z-30-00-20	1SBL276001R2000	0.350									
				24...60	20...60	0 0	AF30Z-30-00-21	1SBL276001R2100	0.350									
				48...130	48...130	0 0	AF30Z-30-00-22	1SBL276001R2200	0.350									
				100...250	100...250	0 0	AF30Z-30-00-23	1SBL276001R2300	0.350									
				-	12...20	0 0	AF38Z-30-00-20	1SBL296001R2000	0.350									
				24...60	20...60	0 0	AF38Z-30-00-21	1SBL296001R2100	0.350									
				48...130	48...130	0 0	AF38Z-30-00-22	1SBL296001R2200	0.350									
				100...250	100...250	0 0	AF38Z-30-00-23	1SBL296001R2300	0.350									

(1) Note: Only AF.Z contactors with DC control voltage 12...20 V DC need to respect the connection polarities indicated close to the coil terminals: A1+ for the positive pole and A2- for the negative pole.

Main dimensions mm, inches

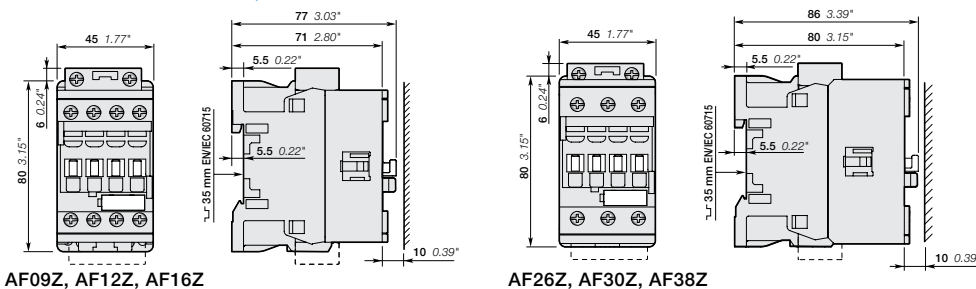

AF40 ... AF96 3-pole contactors

30 to 60 hp at 480 V AC

AC / DC operated with 1 N.O. + 1 N.C. auxiliary contacts

2



AF40-30-11



AF80-30-11

Description

AF40 ... AF96 contactors are mainly used for controlling 3-phase motors and power circuits up to 690 V AC and 220 V DC. These contactors are of the block type design with 3 main poles.

- control circuit: AC or DC operated with electronic coil interface accepting a wide control voltage range (e.g. 100...250 V AC and DC), only 4 control voltage ranges covering 24...500 V 50/60 Hz and 20...500 V DC
- can manage large control voltage variations
- reduced panel energy consumption
- very distinct closing and opening.
- built-in surge suppression
- add-on auxiliary contact blocks for front or side mounting and a wide range of accessories.

Ordering details

IEC		UL / CSA		Rated control circuit voltage		Auxiliary contacts fitted	Catalog number	Global reference code	Weight Pkg (1 pce)
Rated operational power	current $\theta \leq 40^\circ\text{C}$	3-phase motor rating	General use rating	Uc min. ... Uc max.					
400 V AC-3	AC-1	hp	A	V 50/60 Hz	V DC				kg
18.5	70	30	60	24...60	-	1 1	AF40-30-11-41	1SBL347001R4111	1.010
				24...60	20...60 (1)	1 1	AF40-30-11-11	1SBL347001R1111	1.010
				48...130	48...130	1 1	AF40-30-11-12	1SBL347001R1211	1.010
				100...250	100...250	1 1	AF40-30-11-13	1SBL347001R1311	1.000
22	100	40	80	24...60	-	1 1	AF52-30-11-41	1SBL367001R4111	1.010
				24...60	20...60 (1)	1 1	AF52-30-11-11	1SBL367001R1111	1.010
				48...130	48...130	1 1	AF52-30-11-12	1SBL367001R1211	1.010
				100...250	100...250	1 1	AF52-30-11-13	1SBL367001R1311	1.000
30	105	50	90	24...60	-	1 1	AF65-30-11-41	1SBL387001R4111	1.010
				24...60	20...60 (1)	1 1	AF65-30-11-11	1SBL387001R1111	1.010
				48...130	48...130	1 1	AF65-30-11-12	1SBL387001R1211	1.010
				100...250	100...250	1 1	AF65-30-11-13	1SBL387001R1311	1.000
37	125	60	105	24...60	-	1 1	AF80-30-11-41	1SBL397001R4111	1.260
				24...60	20...60 (1)	1 1	AF80-30-11-11	1SBL397001R1111	1.260
				48...130	48...130	1 1	AF80-30-11-12	1SBL397001R1211	1.260
				100...250	100...250	1 1	AF80-30-11-13	1SBL397001R1311	1.210
45	130	60	115	24...60	-	1 1	AF96-30-11-41	1SBL407001R4111	1.260
				24...60	20...60 (1)	1 1	AF96-30-11-11	1SBL407001R1111	1.260
				48...130	48...130	1 1	AF96-30-11-12	1SBL407001R1211	1.260
				100...250	100...250	1 1	AF96-30-11-13	1SBL407001R1311	1.210
				250...500	250...500	1 1	AF96-30-11-14	1SBL407001R1411	1.210

(1) AF.-30-...-11 not suitable for direct control by PLC-output.

Main dimensions mm, inches

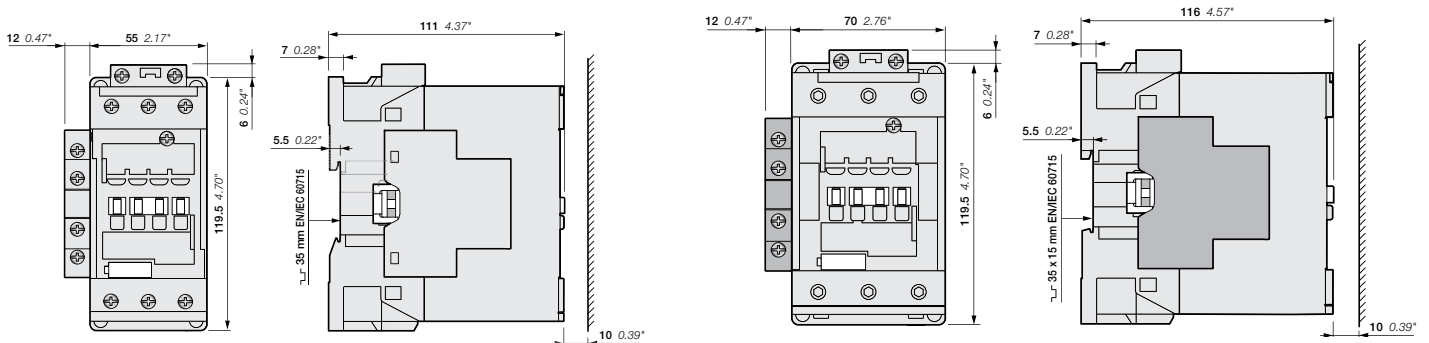

AF40, AF52, AF65

AF80, AF96

AF116 ... AF146 3-pole contactors

75 to 100 hp at 480 V AC

AC / DC operated with 1 N.O. + 1 N.C. auxiliary contacts



AF146-30-11



AF146-30-11B

Description

AF116 ... AF140 contactors are mainly used for controlling 3-phase motors and power circuits up to 690 V AC, AF146 up to 1000 V AC. These contactors are of the block type design with 3 main poles.

- Control circuit: AC or DC operated with electronic coil interface accepting a wide control voltage range (e.g. 100...250 V AC and DC), only 4 control voltage ranges covering 24...500 V 50/60 Hz and 20...500 V DC
- can manage large control voltage variations
- reduced panel energy consumption
- very distinct closing and opening
- can withstand short voltage dips and voltage sags (SEMI F47 conditions of use on request).
- built-in surge suppression
- add-on auxiliary contact blocks for side mounting and a wide range of accessories.

Ordering details

IEC		UL / CSA		Rated control circuit voltage		Auxiliary contacts fitted		Catalog number	Global reference code	Weight Pkg (1 pce)
Rated operational power	operational current $\theta \leq 40^\circ\text{C}$	3-phase motor rating	General use rating	Uc min. ... Uc max.						
400 V AC-3	AC-1	hp	600 V AC	V 50/60 Hz	V DC					kg

For connection with built-in cable clamps

Rated operational power	operational current	3-phase motor rating	General use rating	Uc min. (V 50/60 Hz)	Uc max. (V DC)	NO	NC	Catalog number	Global reference code	Weight
55	160	75	160	24...60	20...60	1	1	AF116-30-11-11	1SFL427001R1111	1.750
				48...130	48...130	1	1	AF116-30-11-12	1SFL427001R1211	1.750
				100...250	100...250	1	1	AF116-30-11-13	1SFL427001R1311	1.750
				250...500	250...500	1	1	AF116-30-11-14	1SFL427001R1411	1.750
75	200	100	200	24...60	20...60	1	1	AF140-30-11-11	1SFL447001R1111	1.750
				48...130	48...130	1	1	AF140-30-11-12	1SFL447001R1211	1.750
				100...250	100...250	1	1	AF140-30-11-13	1SFL447001R1311	1.750
				250...500	250...500	1	1	AF140-30-11-14	1SFL447001R1411	1.750
75	225	100	200	24...60	20...60	1	1	AF146-30-11-11	1SFL467001R1111	1.750
				48...130	48...130	1	1	AF146-30-11-12	1SFL467001R1211	1.750
				100...250	100...250	1	1	AF146-30-11-13	1SFL467001R1311	1.750
				250...500	250...500	1	1	AF146-30-11-14	1SFL467001R1411	1.750

With bar connections

Rated operational power	operational current	3-phase motor rating	General use rating	Uc min. (V 50/60 Hz)	Uc max. (V DC)	NO	NC	Catalog number	Global reference code	Weight
55	160	75	160	24...60	20...60	1	1	AF116-30-11B-11	1SFL427002R1111	1.500
				48...130	48...130	1	1	AF116-30-11B-12	1SFL427002R1211	1.500
				100...250	100...250	1	1	AF116-30-11B-13	1SFL427002R1311	1.500
				250...500	250...500	1	1	AF116-30-11B-14	1SFL427002R1411	1.500
75	200	100	200	24...60	20...60	1	1	AF140-30-11B-11	1SFL447002R1111	1.500
				48...130	48...130	1	1	AF140-30-11B-12	1SFL447002R1211	1.500
				100...250	100...250	1	1	AF140-30-11B-13	1SFL447002R1311	1.500
				250...500	250...500	1	1	AF140-30-11B-14	1SFL447002R1411	1.500
75	225	100	200	24...60	20...60	1	1	AF146-30-11B-11	1SFL467002R1111	1.500
				48...130	48...130	1	1	AF146-30-11B-12	1SFL467002R1211	1.500
				100...250	100...250	1	1	AF146-30-11B-13	1SFL467002R1311	1.500
				250...500	250...500	1	1	AF146-30-11B-14	1SFL467002R1411	1.500

Main dimensions mm, inches

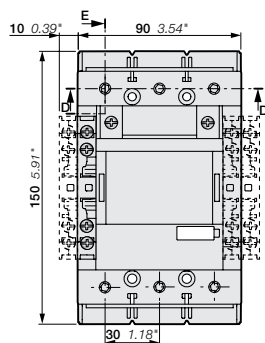

AF116, AF140, AF146-30-11

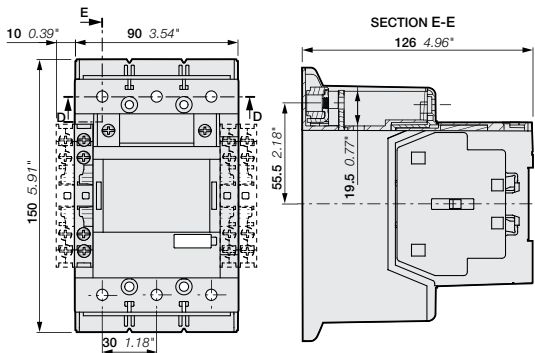

AF116, AF140, AF146-30-11B

AF190 ... AF370 3-pole contactors

125 to 300 hp at 480 V AC

AC / DC operated with 1 N.O. + 1 N.C. auxiliary contacts

2



AF205-30-11



AF370-30-11

Description

AF190 ... AF370 contactors are mainly used for controlling 3-phase motors and power circuits up to 1000 V AC. These contactors are of the block type design with 3 main poles.

- control circuit: AC or DC operated with electronic coil interface accepting a wide control voltage range (e.g. 100...250 V AC and DC), only 4 control voltage ranges covering 24...500 V 50/60 Hz and 20...500 V DC
- can manage large control voltage variations
- reduced panel energy consumption
- very distinct closing and opening
- can withstand short voltage dips and voltage sags (SEMI F47 conditions of use on request).
- built-in surge suppression
- add-on auxiliary contact blocks for side mounting and a wide range of accessories.

Ordering details

IEC		UL / CSA		Rated control circuit voltage		Auxiliary contacts fitted	Catalog number	Global reference code	Weight
Rated operational power	current $\theta \leq 40^\circ\text{C}$	3-phase motor rating	General use rating	Uc min. ... Uc max.					
400 V AC-3	AC-1	480 V	600 V AC	V 50/60 Hz	V DC				Pkg (1 pce)
kW	A	hp	A (1)						kg
90	275	125	230 [250]	24...60	20...60	1 1	AF190-30-11-11	1SFL487002R1111	3.000
				48...130	48...130	1 1	AF190-30-11-12	1SFL487002R1211	3.000
				100...250	100...250	1 1	AF190-30-11-13	1SFL487002R1311	3.000
				250...500	250...500	1 1	AF190-30-11-14	1SFL487002R1411	3.000
110	350	150	250 [300]	24...60	20...60	1 1	AF205-30-11-11	1SFL527002R1111	3.000
				48...130	48...130	1 1	AF205-30-11-12	1SFL527002R1211	3.000
				100...250	100...250	1 1	AF205-30-11-13	1SFL527002R1311	3.000
				250...500	250...500	1 1	AF205-30-11-14	1SFL527002R1411	3.000
140	400	200	300 [350]	24...60	20...60	1 1	AF265-30-11-11	1SFL547002R1111	4.640
				48...130	48...130	1 1	AF265-30-11-12	1SFL547002R1211	4.640
				100...250	100...250	1 1	AF265-30-11-13	1SFL547002R1311	4.640
				250...500	250...500	1 1	AF265-30-11-14	1SFL547002R1411	4.640
160	500	250	350 [400]	24...60	20...60	1 1	AF305-30-11-11	1SFL587002R1111	4.640
				48...130	48...130	1 1	AF305-30-11-12	1SFL587002R1211	4.640
				100...250	100...250	1 1	AF305-30-11-13	1SFL587002R1311	4.640
				250...500	250...500	1 1	AF305-30-11-14	1SFL587002R1411	4.640
200	600	300	400 [520]	24...60	20...60	1 1	AF370-30-11-11	1SFL607002R1111	4.640
				48...130	48...130	1 1	AF370-30-11-12	1SFL607002R1211	4.640
				100...250	100...250	1 1	AF370-30-11-13	1SFL607002R1311	4.640
				250...500	250...500	1 1	AF370-30-11-14	1SFL607002R1411	4.640

(1) The higher ratings shown in [brackets] can be achieved through the use of LX.. terminal extensions.

Main dimensions mm, inches

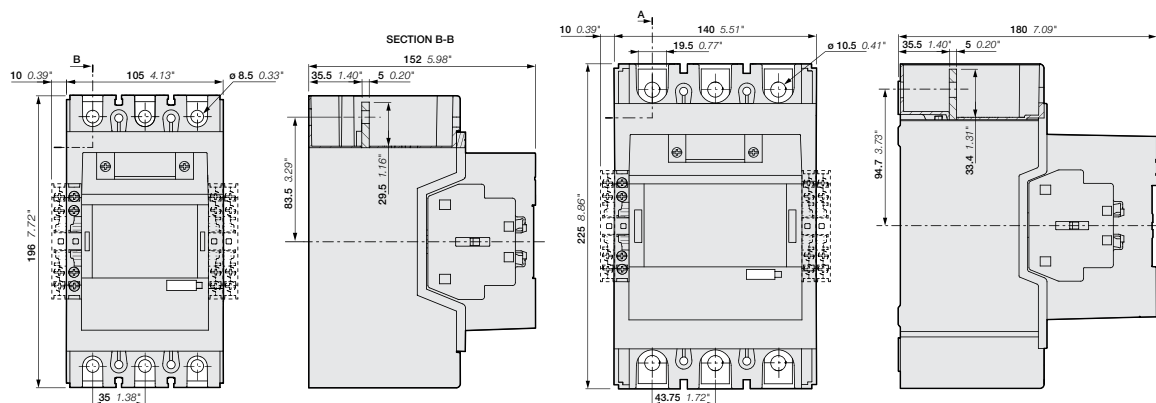

AF190, AF205

AF265, AF305, AF370

AF400 ... AF750 3-pole contactors

350 to 600 hp at 480 V AC

AC / DC operated with 1 N.O. + 1 N.C. auxiliary contacts



AF460-30-11



AF750-30-11

Description

AF400 ... AF750 contactors are mainly used for controlling 3-phase motors and power circuits up to 1000 V AC or 600 V DC (2). These contactors are of the block type design with 3 main poles.

- control circuit: AC or DC operated with electronic coil interface accepting a wide control voltage range (e.g. 100...250 V AC and DC), only 4 coils to cover control voltages between 48...500 V 50/60 Hz and 24...500 V DC
 - can manage large control voltage variations
 - reduced panel energy consumption
 - very distinct closing and opening
 - can withstand short voltage dips and voltages sags (SEMI F47 conditions of use on request).
- built-in surge suppression
- add-on auxiliary contact blocks for side mounting and a wide range of accessories.

Ordering details

IEC		UL/CSA		Rated control circuit voltage		Auxiliary contacts fitted	Catalog number	Global reference code	Weight
Rated operational power	operational current $\theta \leq 40^\circ\text{C}$	3-phase motor rating	General use rating	Uc min. ... Uc max.					
400 V AC-3	690 V AC-1	hp	A	V 50/60 Hz	V DC				kg
200	600	350	550	-	24...60 (1)	1 1	AF400-30-11-68	1SFL577001R6811	12.000
				48...130	48...130	1 1	AF400-30-11-69	1SFL577001R6911	12.000
				100...250	100...250	1 1	AF400-30-11-70	1SFL577001R7011	12.000
				250...500	250...500	1 1	AF400-30-11-71	1SFL577001R7111	12.000
250	700	400	650	-	24...60 (1)	1 1	AF460-30-11-68	1SFL597001R6811	12.000
				48...130	48...130	1 1	AF460-30-11-69	1SFL597001R6911	12.000
				100...250	100...250	1 1	AF460-30-11-70	1SFL597001R7011	12.000
				250...500	250...500	1 1	AF460-30-11-71	1SFL597001R7111	12.000
315	800	500	750	-	24...60 (1)	1 1	AF580-30-11-68	1SFL617001R6811	15.000
				48...130	48...130	1 1	AF580-30-11-69	1SFL617001R6911	15.000
				100...250	100...250	1 1	AF580-30-11-70	1SFL617001R7011	15.000
				250...500	250...500	1 1	AF580-30-11-71	1SFL617001R7111	15.000
400	1050	600	900	-	24...60 (1)	1 1	AF750-30-11-68	1SFL637001R6811	15.000
				48...130	48...130	1 1	AF750-30-11-69	1SFL637001R6911	15.000
				100...250	100...250	1 1	AF750-30-11-70	1SFL637001R7011	15.000
				250...500	250...500	1 1	AF750-30-11-71	1SFL637001R7111	15.000

(1) The connection polarities indicated close to the coil terminals must be respected: A1 for the positive pole and A2 for the negative pole.
 (2) Up to 850 V DC for AF580, AF750.

Control inputs

AF400 ... AF750 are equipped with low voltage inputs for control, for example by a PLC.

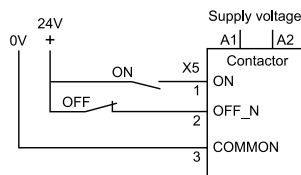

Main dimensions mm, inches

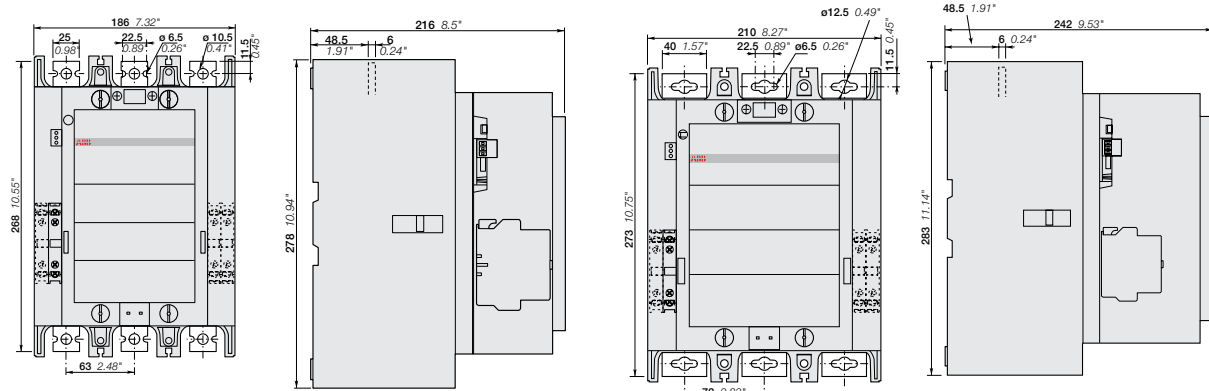

AF400, AF460

AF580, AF750

AF1250 ... AF2650 3-pole contactors

800 to 900 hp at 480 V AC and up to 2700 A general use AC / DC operated with 1 N.O. + 1 N.C. auxiliary contacts

2



AF1250-30-11



AF2650-30-11

Description

AF1250 ... AF2050 contactors are mainly used for controlling power circuits up to 1000 V AC or 850 V DC, AF2650 for controlling power up to 1000 V AC. These contactors are of the block type design with 3 main poles.

- control circuit: AC or DC operated with electronic coil interface accepting a wide control voltage range (e.g. 100...250 V AC and DC)

- only 4 coils for AF1250 to cover control voltages between 48...500 V 50/60 Hz and 24...500 V DC
 - only 1 coil for AF1350 ... AF2650 to cover control voltages between 100...250 V 50/60 Hz and 100...250 V DC

- can manage large control voltage variations

- reduced panel energy consumption

- very distinct closing and opening

- can withstand short voltage dips and voltages sags (SEMI F47 conditions of use on request).

- built-in surge suppression

- add-on auxiliary contact blocks for side mounting and a wide range of accessories.

Ordering details

IEC Rated operational power 400 V AC-3 kW	UL/CSA 3-phase motor rating 480 V hp	General use rating 600 V AC A (2)	Rated control circuit voltage U _c (1)		Auxiliary contacts fitted	Catalog number	Global reference code	Weight Pkg (1 pce) kg	
			V 50/60 Hz	V DC					
-	1260	-	1210	-	24...60 (1)	1 1	AF1250-30-11-68	1SFL647001R6811	16.000
				48...130	48...130	1 1	AF1250-30-11-69	1SFL647001R6911	16.000
				100...250	100...250	1 1	AF1250-30-11-70	1SFL647001R7011	16.000
				250...500	250...500	1 1	AF1250-30-11-71	1SFL647001R7111	16.000
475	1350	800	1350	100...250	100...250	1 1	AF1350-30-11-70	1SFL657001R7011	34.000
560	1650	900	1650	100...250	100...250	1 1	AF1650-30-11-70	1SFL677001R7011	35.000
-	2050	-	2100	100...250	100...250	1 1	AF2050-30-11-70	1SFL707001R7011	35.000
-	2650	-	2700	100...250	100...250	1 1	AF2650-30-11-70	1SFL667001R7011	45.000

(1) The connection polarities indicated close to the coil terminals must be respected: A1 for the positive pole and A2 for the negative pole.

(2) AF2650 : Maximum operational voltage = 1000 V according to UL / CSA.

Control inputs

AF1250 ... AF2650 are equipped with low voltage inputs for control, for example by a PLC

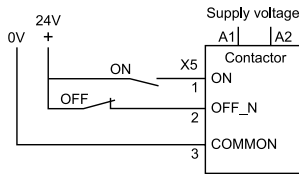

	AF1350, AF1650, AF2050	AF2650
A	392 mm / 15.43"	422 mm / 16.61"
B	47 mm / 1.85"	53.5 mm / 2.11"
C	10 mm / 0.39"	25 mm / 0.98"
D	3 mm / 0.12"	-

Main dimensions mm, inches

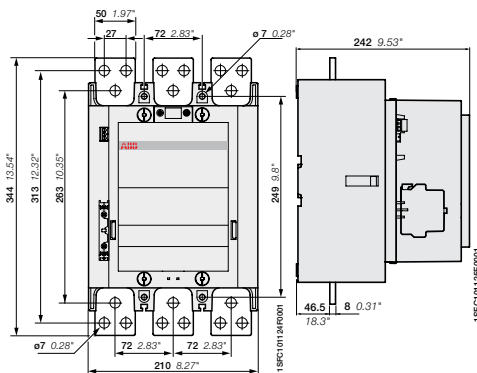

AF1250

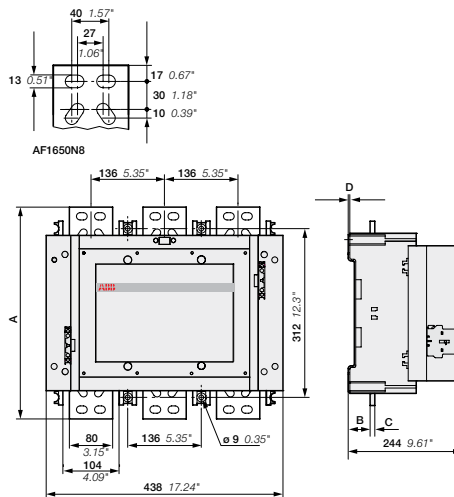

AF1350, AF1650, AF2050, AF2650

AF09R ... AF30R 3-pole reversing contactors

5 to 20 hp at 480 V AC

AC / DC operated



AF09R-30-22

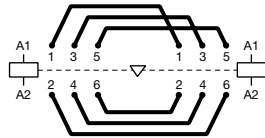

Power bus diagram

Description

- AF09R ... AF30R reversing contactors are mainly used for directionally controlling 3-phase motor circuits up to 690V AC. These devices include two 3-pole contactors, a mechanical and electrical interlock, power bus (see diagram to the left), and are assembled using fixing clips.
- **Note: for mechanically and electrically interlocked devices without power bus, replace the R in the catalog number with an M (ie. AF09R-30-22-13 becomes AF09M-30-22-13).**
- Control circuit: AC or DC operated with electronic coil interface accepting a wide control voltage range (e.g. 100...250 V AC and DC), only 4 control voltage ranges covering 24...500V 50/60 Hz and 20...500 V DC
 - can manage large control voltage variations
 - reduced panel energy consumption
 - very distinct closing and opening.
- Built-in surge suppression
- Add-on auxiliary contact blocks for front or side mounting and a wide range of accessories.

Ordering details

IEC		UL/CSA		Rated control circuit voltage		Auxiliary contacts fitted		Catalog number	Global reference code (3)	Weight Pkg (1 pce)
Rated operational power	Rated operational current $\theta \leq 40^\circ\text{C}$	3-phase motor rating	General use rating	Uc min. ... Uc max.						
400 V AC-3	AC-1	480 V	600 V AC	V 50/60 Hz	V DC					kg
4	25	5	25	24...60	-	(1)	2 2	AF09R-30-22-41		0.622
				48...130	48...130		2 2	AF09R-30-22-12		0.622
				100...250	100...250		2 2	AF09R-30-22-13		0.622
				250...500	250...500		2 2	AF09R-30-22-14		0.702
5.5	28	7.5	28	24...60	-	(1)	2 2	AF12R-30-22-41		0.622
				48...130	48...130		2 2	AF12R-30-22-12		0.622
				100...250	100...250		2 2	AF12R-30-22-13		0.622
				250...500	250...500		2 2	AF12R-30-22-14		0.702
7.5	30	10	30	24...60	-	(1)	2 2	AF16R-30-22-41		0.622
				48...130	48...130		2 2	AF16R-30-22-12		0.622
				100...250	100...250		2 2	AF16R-30-22-13		0.622
				250...500	250...500		2 2	AF16R-30-22-14		0.702
11	45	15	45	24...60	-	(1)	0 2	AF26R-30-02-41		0.757
							2 2	AF26R-30-22-41		0.785
				48...130	48...130		0 2	AF26R-30-02-12		0.757
							2 2	AF26R-30-22-12		0.785
				100...250	100...250		0 2	AF26R-30-02-13		0.757
							2 2	AF26R-30-22-13		0.785
				250...500	250...500		0 2	AF26R-30-02-14		0.837
							2 2	AF26R-30-22-14		0.865
15	50	20	50	24...60	-	(1)	0 2	AF30R-30-02-41		0.757
							2 2	AF30R-30-22-41		0.785
				48...130	48...130		0 2	AF30R-30-02-12		0.757
							2 2	AF30R-30-22-12		0.785
				100...250	100...250		0 2	AF30R-30-02-13		0.757
							2 2	AF30R-30-22-13		0.785
				250...500	250...500		0 2	AF30R-30-02-14		0.837
							2 2	AF30R-30-22-14		0.865

(1) For 24...60 V 50/60 Hz - 20...60 V DC, use AF.-30-.-11 (see voltage code table). AF.-30-.-11 not suitable for direct control by PLC-output.
 (2) Normally closed contacts included as part of the electrical interlock. Normally open auxiliaries are either integral or front-mount.
 (3) Available in the US and Canada only.

Mounting dimensions mm, inches

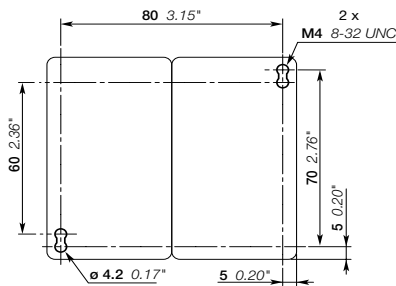

AF09R, AF12R, AF16R

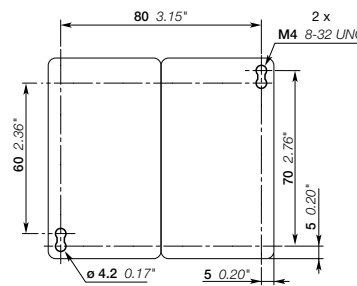

AF26R, AF30R

AF09ZR ... AF30ZR 3-pole reversing contactors

5 to 20 hp at 480 V AC

AC / DC operated - low consumption



AF09ZR-30-22

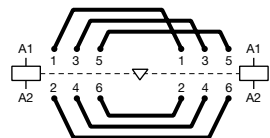

Power bus diagram

Description

- AF09ZR ... AF30ZR reversing contactors are mainly used for directionally controlling 3-phase motor circuits up to 690V AC. These devices include two 3-pole contactors, a mechanical and electrical interlock, power bus (see diagram to the left), and are assembled using fixing clips.
- **Note: for mechanically and electrically interlocked devices without power bus, replace the R in the catalog number with an M (ie. AF09ZR-30-22-23 becomes AF09ZM-30-22-23).**
- Control circuit: AC or DC operated with electronic coil interface accepting a wide control voltage
- Range (e.g. 100...250 V AC and DC), only 4 control voltage ranges covering 24...250 V 50/60 Hz and 20...250 V DC
 - can manage large control voltage variations
 - allow direct control by PLC-output ≥ 24 V DC 500 mA
 - reduced panel energy consumption
 - very distinct closing and opening
 - can withstand short voltage dips and voltage sags (SEMI F47-0706 conditions of use on request).
- Built-in surge suppression
- Add-on auxiliary contact blocks for front or side mounting and a wide range of accessories.

Ordering details

IEC Rated operational power kW	UL/CSA 3-phase motor rating 480 V AC-1 A	General use rating 600 V AC hp	Rated control circuit voltage Uc min. ... Uc max.		Auxiliary contacts fitted (1)	Catalog number	Global reference code (2)	Weight Pkg (1 pce) kg	
			V 50/60 Hz	V DC					
4	25	5	25	24...60	20...60	2	2	AF09ZR-30-22-21	0.702
				48...130	48...130	2	2	AF09ZR-30-22-22	0.702
				100...250	100...250	2	2	AF09ZR-30-22-23	0.702
5.5	28	7.5	28	24...60	20...60	2	2	AF12ZR-30-22-21	0.702
				48...130	48...130	2	2	AF12ZR-30-22-22	0.702
				100...250	100...250	2	2	AF12ZR-30-22-23	0.702
7.5	30	10	30	24...60	20...60	2	2	AF16ZR-30-22-21	0.702
				48...130	48...130	2	2	AF16ZR-30-22-22	0.702
				100...250	100...250	2	2	AF16ZR-30-22-23	0.702
11	45	15	45	24...60	20...60	0	2	AF26ZR-30-02-21	0.837
				48...130	48...130	2	2	AF26ZR-30-02-22	0.837
				100...250	100...250	2	2	AF26ZR-30-02-23	0.837
				24...60	20...60	2	2	AF26ZR-30-22-21	0.865
				48...130	48...130	0	2	AF26ZR-30-22-22	0.837
				100...250	100...250	0	2	AF26ZR-30-22-23	0.837
15	50	20	50	24...60	20...60	0	2	AF30ZR-30-02-21	0.837
				48...130	48...130	2	2	AF30ZR-30-02-22	0.837
				100...250	100...250	2	2	AF30ZR-30-02-23	0.865
				24...60	20...60	2	2	AF30ZR-30-22-21	0.865
				48...130	48...130	0	2	AF30ZR-30-22-22	0.837
				100...250	100...250	0	2	AF30ZR-30-22-23	0.837

(1) Normally closed contacts included as part of the electrical interlock. Normally open auxiliaries are either integral or front-mount.
 (2) Available in the US and Canada only.

Mounting dimensions mm, inches

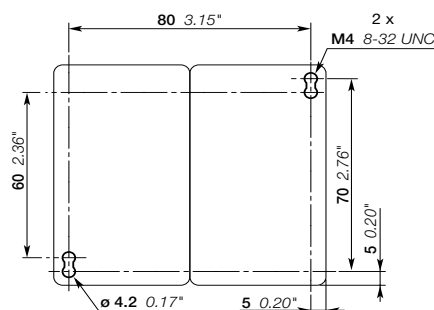

AF09ZR, AF12ZR, AF16ZR

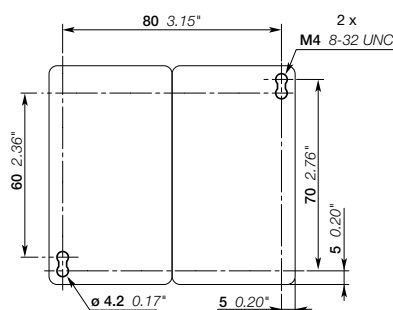

AF26ZR, AF30ZR

AF40R ... AF96R 3-pole reversing contactors

30 to 60 hp at 480 V AC

AC / DC operated



AF40M-30-22

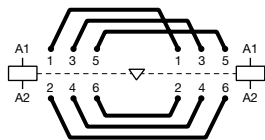

Power bus diagram

Description

- AF40R ... AF96R reversing contactors are mainly used for directionally controlling 3-phase motor circuits up to 690V AC. These devices include two 3-pole contactors, a mechanical interlock, side-mounted auxiliary contacts for electrical interlocking, power bus (see diagram to the left), and are assembled using fixing clips.
- **Note: for mechanically and electrically interlocked devices without power bus, replace the R in the catalog number with an M (ie. AF40R-30-22-13 becomes AF40M-30-22-13).**
- Control circuit: AC or DC operated with electronic coil interface accepting a wide control voltage
- range (e.g. 100...250 V AC and DC), only 4 control voltage ranges covering 24...500V 50/60 Hz and 20...500 V DC
 - can manage large control voltage variations
 - reduced panel energy consumption
 - very distinct closing and opening.
- Built-in surge suppression
- Add-on auxiliary contact blocks for front or side mounting and a wide range of accessories.

Ordering details

IEC		UL / CSA		Rated control circuit voltage		Auxiliary contacts fitted	Catalog number	Global reference code (2)	Weight Pkg (1 pce)							
Rated operational power	current $\theta \leq 40^\circ\text{C}$	3-phase motor rating	General use rating	Uc min. ... Uc max.												
400 V AC-3	A	hp	A	V 50/60 Hz	V DC				kg							
				18.5	70					30	60	24...60	-	2 2	AF40R-30-22-41	2.283
												24...60	20...60 (1)	2 2	AF40R-30-22-11	2.283
												48...130	48...130	2 2	AF40R-30-22-12	2.283
												100...250	100...250	2 2	AF40R-30-22-13	2.263
												250...500	250...500	2 2	AF40R-30-22-14	2.263
				22	100					40	80	24...60	-	2 2	AF52R-30-22-41	2.283
												24...60	20...60 (1)	2 2	AF52R-30-22-11	2.283
												48...130	48...130	2 2	AF52R-30-22-12	2.283
												100...250	100...250	2 2	AF52R-30-22-13	2.263
				250...500	250...500	2 2	AF52R-30-22-14	2.263								
30	105	50	90	24...60	-	2 2	AF65R-30-22-41	2.283								
				24...60	20...60 (1)	2 2	AF65R-30-22-11	2.283								
				48...130	48...130	2 2	AF65R-30-22-12	2.283								
				100...250	100...250	2 2	AF65R-30-22-13	2.263								
				250...500	250...500	2 2	AF65R-30-22-14	2.263								
37	125	60	105	24...60	-	2 2	AF80R-30-22-41	2.858								
				24...60	20...60 (1)	2 2	AF80R-30-22-11	2.858								
				48...130	48...130	2 2	AF80R-30-22-12	2.858								
				100...250	100...250	2 2	AF80R-30-22-13	2.758								
				250...500	250...500	2 2	AF80R-30-22-14	2.758								
45	130	60	115	24...60	-	2 2	AF96R-30-22-41	2.858								
				24...60	20...60 (1)	2 2	AF96R-30-22-11	2.858								
				48...130	48...130	2 2	AF96R-30-22-12	2.858								
				100...250	100...250	2 2	AF96R-30-22-13	2.758								
				250...500	250...500	2 2	AF96R-30-22-14	2.758								

(1) AF..-30...-11 not suitable for direct control by PLC-output.
 (2) Available in the US and Canada only.

Mounting dimensions mm, inches

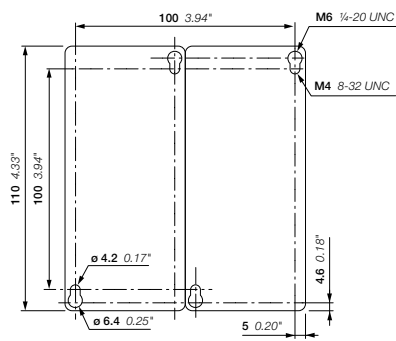

AF40R, AF52R, AF65R

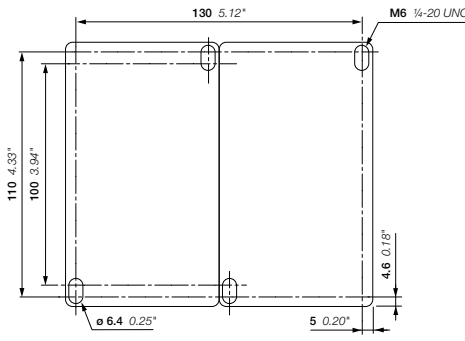

AF80R, AF96R

AF116R ... AF140R 3-pole reversing contactors

75 to 100 hp at 480 V AC

AC / DC operated

2



AF140R-30-22

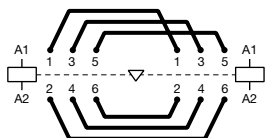

Power bus diagram

Description

AF116R and AF140R reversing contactors are mainly used for directionally controlling 3-phase motor circuits up to 690V AC. These devices include two 3-pole contactors, a mechanical interlock, side-mounted auxiliary contacts for electrical interlocking, power bus (see diagram to the left), and are mounted on a backplate.

Note: for mechanically and electrically interlocked devices without power bus, replace the R in the catalog number with an M (ie. AF116R-30-22-13 becomes AF116M-30-22-13).

- Control circuit: AC or DC operated with electronic coil interface accepting a wide control voltage range (e.g. 100...250 V AC and DC), only 4 control voltage ranges covering 24...500V 50/60 Hz and 20...500 V DC
- can manage large control voltage variations
- reduced panel energy consumption
- very distinct closing and opening
- can withstand short voltage dips and voltage sags (SEMI F47-0706 conditions of use on request).
- Built-in surge suppression
- Add-on auxiliary contact blocks for side mounting and a wide range of accessories.

Ordering details

IEC		UL / CSA		Rated control circuit voltage		Auxiliary contacts fitted		Catalog number	Global reference code (1)	Weight Pkg (1 pce)
Rated operational power	current $\theta \leq 40^\circ\text{C}$	3-phase motor rating 480 V	General use rating 600 V AC	Uc min. ... Uc max.						
400 V	AC-3	AC-1		V 50/60 Hz	V DC					kg (2)

For connection with built-in cable clamps

55	160	75	160	24...60	20...60	2	2	AF116R-30-22-11		
				48...130	48...130	2	2	AF116R-30-22-12		
				100...250	100...250	2	2	AF116R-30-22-13		
				250...500	250...500	2	2	AF116R-30-22-14		
75	200	100	200	24...60	20...60	2	2	AF140R-30-22-11		
				48...130	48...130	2	2	AF140R-30-22-12		
				100...250	100...250	2	2	AF140R-30-22-13		
				250...500	250...500	2	2	AF140R-30-22-14		

(1) Available in the US and Canada only.

(2) Available upon request.

Mounting dimensions mm, inches (upon request)

AF190R ... AF370R 3-pole reversing contactors

125 to 300 hp at 480 V AC

AC / DC operated



AF205M-30-22

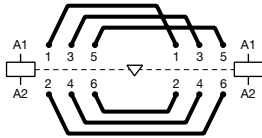

Power bus diagram

Description

AF190R ... AF370R reversing contactors are mainly used for directionally controlling 3-phase motor circuits up to 690V AC. These devices include two 3-pole contactors, a mechanical interlock, side-mounted auxiliary contacts for electrical interlocking, power bus (see diagram to the left), and are mounted on a backplate.

Note: for mechanically and electrically interlocked devices without power bus, replace the R in the catalog number with an M (ie. AF190R-30-22-13 becomes AF190M-30-22-13).

- Control circuit: AC or DC operated with electronic coil interface accepting a wide control voltage range (e.g. 100...250 V AC and DC), only 4 control voltage ranges covering 24...500V 50/60 Hz and 20...500 V DC
- can manage large control voltage variations
- reduced panel energy consumption
- very distinct closing and opening
- can withstand short voltage dips and voltage sags (SEMI F47-0706 conditions of use on request).
- Built-in surge suppression
- Add-on auxiliary contact blocks for side mounting and a wide range of accessories.

Ordering details

IEC Rated operational power	UL / CSA 3-phase motor rating 480 V	General use rating 600 V AC	Rated control circuit voltage Uc min. ... Uc max.		Auxiliary contacts fitted	Catalog number	Global reference code (2)	Weight Pkg (1 pce)
			V 50/60 Hz	V DC				
400 V AC-3	AC-1							
kW	A	hp	A (1)					kg (3)
90	275	125	230 [250]	24...60 48...130 100...250 250...500	20...60 48...130 100...250 250...500	2 2 2 2 2 2 2 2	AF190R-30-22-11 AF190R-30-22-12 AF190R-30-22-13 AF190R-30-22-14	
110	350	150	250 [300]	24...60 48...130 100...250 250...500	20...60 48...130 100...250 250...500	2 2 2 2 2 2 2 2	AF205R-30-22-11 AF205R-30-22-12 AF205R-30-22-13 AF205R-30-22-14	
140	400	200	300 [350]	24...60 48...130 100...250 250...500	20...60 48...130 100...250 250...500	2 2 2 2 2 2 2 2	AF265R-30-22-11 AF265R-30-22-12 AF265R-30-22-13 AF265R-30-22-14	
160	500	250	350 [400]	24...60 48...130 100...250 250...500	20...60 48...130 100...250 250...500	2 2 2 2 2 2 2 2	AF305R-30-22-11 AF305R-30-22-12 AF305R-30-22-13 AF305R-30-22-14	
200	600	300	400 [520]	24...60 48...130 100...250 250...500	20...60 48...130 100...250 250...500	2 2 2 2 2 2 2 2	AF370R-30-22-11 AF370R-30-22-12 AF370R-30-22-13 AF370R-30-22-14	

(1) The higher ratings shown in [brackets] can be achieved through the use of LX.. Terminal extensions. Terminal extensions are included as standard for reversing contactors, but must be purchased separately for mechanically and electrically interlocked devices.
 (2) Available in the US and Canada only.
 (3) Available upon request.

Mounting dimensions mm, inches (upon request)

AF400R ... AF750R 3-pole reversing contactors

350 to 600 hp at 480 V AC

AC / DC operated

2



AF460R-30-11

Description

- AF400R ... AF750R reversing contactors are mainly used for directionally controlling 3-phase motor circuits up to 690V AC. These devices include two 3-pole contactors, a mechanical interlock, side-mounted auxiliary contacts for electrical interlocking, power bus (see diagram to the left), and are mounted on a back-plate.
- **Note: for mechanically and electrically interlocked devices without power bus, replace the R in the catalog number with an M (ie. AF400R-30-22-70 becomes AF400M-30-22-70).**
- Control circuit: AC or DC operated with electronic coil interface accepting a wide control voltage
- Range (e.g. 100...250 V AC and DC), only 4 control voltage ranges covering 24...500V 50/60 Hz and 20...500 V DC
 - can manage large control voltage variations
 - reduced panel energy consumption
 - very distinct closing and opening
 - can withstand short voltage dips and voltage sags (SEMI F47-0706 conditions of use on request).
- Built-in surge suppression
- Add-on auxiliary contact blocks for side mounting and a wide range of accessories.

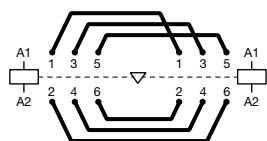

Power bus diagram

Ordering details

IEC Rated operational power	UL/CSA 3-phase motor rating 480 V	General use rating 600 V AC	Rated control circuit voltage Uc min. ... Uc max.		Auxiliary contacts fitted	Catalog number	Global reference code (2)	Weight Pkg (1 pce) kg (3)
			V 50/60 Hz	V DC				
400 V AC-3 kW	AC-1 current $\theta \leq 40^\circ\text{C}$ A	hp	A	-	24...60 (1)	2 2	AF400R-30-11-68	
				48...130	48...130	2 2	AF400R-30-11-69	
				100...250	100...250	2 2	AF400R-30-11-70	
				250...500	250...500	2 2	AF400R-30-11-71	
250	700	400	650	-	24...60 (1)	2 2	AF460R-30-11-68	
				48...130	48...130	2 2	AF460R-30-11-69	
				100...250	100...250	2 2	AF460R-30-11-70	
				250...500	250...500	2 2	AF460R-30-11-71	
315	800	500	750	-	24...60 (1)	2 2	AF580R-30-11-68	
				48...130	48...130	2 2	AF580R-30-11-69	
				100...250	100...250	2 2	AF580R-30-11-70	
				250...500	250...500	2 2	AF580R-30-11-71	
400	1050	600	900	-	24...60 (1)	2 2	AF750R-30-11-68	
				48...130	48...130	2 2	AF750R-30-11-69	
				100...250	100...250	2 2	AF750R-30-11-70	
				250...500	250...500	2 2	AF750R-30-11-71	

- (1) The connection polarities indicated close to the coil terminals must be respected: A1 for the positive pole and A2 for the negative pole.
 (2) Available in the US and Canada only.
 (3) Available upon request.

Control inputs

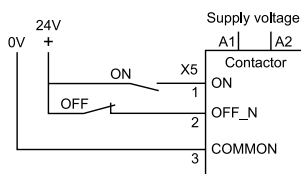

Mounting dimensions mm, inches (upon request)

AF09N00 ... AF26N1 3-pole NEMA rated contactors

Sizes 00 to 1

AC / DC operated



AF09N00-30-10



AF26N1-30-00

Description

- AF09N00 ... AF26N1 NEMA rated contactors are mainly used for controlling 3-phase motor circuits up to 575V AC. These contactors are of the block type design with 3 main poles.
- Control circuit: AC or DC operated with electronic coil interface accepting a wide control voltage range (e.g. 100...250 V AC and DC), only 4 control voltage ranges covering 24...500V 50/60 Hz and 20...500 V DC
 - can manage large control voltage variations
 - reduced panel energy consumption
 - very distinct closing and opening.
- Built-in surge suppression
- Add-on auxiliary contact blocks for front or side mounting and a wide range of accessories.

Ordering details

NEMA				Rated control circuit voltage		Auxiliary contacts fitted	Catalog number	Global reference code (2)	Weight Pkg (1 pce)
Size	Continuous current	3-phase motor rating		Uc min. ... Uc max.					
	A	230 V hp	460/575V hp	V 50/60 Hz	V DC				kg
00	9	1.5	25	24...60	-	(1)	1 0	AF09N00-30-10-41	0.270
				48...130	48...130	1 0	AF09N00-30-01-41	0.270	
				100...250	100...250	1 0	AF09N00-30-10-12	0.270	
				100...250	100...250	1 0	AF09N00-30-01-12	0.270	
				100...250	100...250	1 0	AF09N00-30-10-13	0.270	
0	18	3	5	24...60	-	(1)	0 1	AF09N00-30-01-14	0.310
				48...130	48...130	1 0	AF12N0-30-10-41	0.270	
				100...250	100...250	1 0	AF12N0-30-10-12	0.270	
				100...250	100...250	1 0	AF12N0-30-01-12	0.270	
				100...250	100...250	1 0	AF12N0-30-10-13	0.270	
1	27	7.5	10	24...60	-	(1)	0 0	AF12N0-30-01-14	0.310
				48...130	48...130	0 0	AF26N1-30-00-12	0.310	
				100...250	100...250	0 0	AF26N1-30-00-13	0.310	
				100...250	100...250	0 0	AF26N1-30-00-14	0.310	
				250...500	250...500	0 0	AF26N1-30-00-14	0.350	

(1) For 24...60 V 50/60 Hz - 20...60 V DC, use AF.-30-.-11 (see voltage code table). AF.-30-.-11 not suitable for direct control by PLC-output.

(2) Available in the US and Canada only.

Main dimensions mm, inches

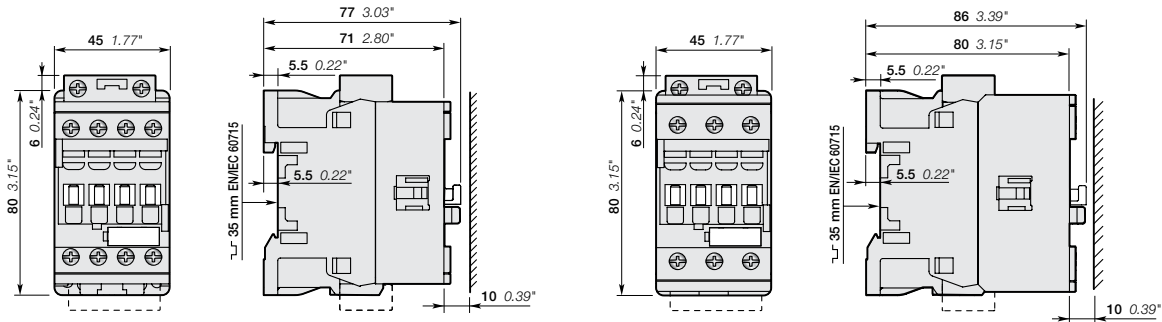

AF09N00, AF12N0

AF26N1

AF09N00Z ... AF26N1Z 3-pole NEMA rated contactors

Sizes 00 to 1

AC / DC operated - low consumption

2



AF09N00Z-30-10



AF26N1Z-30-00

Description

- AF09N00 ... AF26N1 NEMA rated contactors are mainly used for controlling 3-phase motor circuits up to 575V AC. These contactors are of the block type design with 3 main poles.
- Control circuit: AC or DC operated with electronic coil interface accepting a wide control voltage range (e.g. 100...250 V AC and DC), only 4 control voltage ranges covering 24...500V 50/60 Hz and 20...500 V DC
 - can manage large control voltage variations
 - reduced panel energy consumption
 - very distinct closing and opening.
- Built-in surge suppression
- Add-on auxiliary contact blocks for front or side mounting and a wide range of accessories.

Ordering details

NEMA				Rated control circuit voltage		Auxiliary contacts fitted	Catalog number	Global reference code (2)	Weight Pkg (1 pce)
Size	Continuous current	3-phase motor rating		Uc min. ... Uc max.					
	A	230 V hp	460/575V hp	V 50/60 Hz	V DC			kg	
0	9	1.5	25	-	12...20 (1)	1 0	AF09N00Z-30-10-20	0.310	
						0 1	AF09N00Z-30-01-20	0.310	
				24...60	20...60	1 0	AF09N00Z-30-10-21	0.310	
						0 1	AF09N00Z-30-01-21	0.310	
				48...130	48...130	1 0	AF09N00Z-30-10-22	0.310	
						0 1	AF09N00Z-30-01-22	0.310	
				100...250	100...250	1 0	AF09N00Z-30-10-23	0.310	
						0 1	AF09N00Z-30-01-23	0.310	
0	18	3	5	-	12...20 (1)	1 0	AF12N0Z-30-10-20	0.310	
						0 1	AF12N0Z-30-01-20	0.310	
				24...60	20...60	1 0	AF12N0Z-30-10-21	0.310	
						0 1	AF12N0Z-30-01-21	0.310	
				48...130	48...130	1 0	AF12N0Z-30-10-22	0.310	
						0 1	AF12N0Z-30-01-22	0.310	
				100...250	100...250	1 0	AF12N0Z-30-10-23	0.310	
						0 1	AF12N0Z-30-01-23	0.310	
1	27	7.5	10	-	12...20 (1)	0 0	AF26N1Z-30-00-20	0.350	
				24...60	20...60	0 0	AF26N1Z-30-00-21	0.350	
				48...130	48...130	0 0	AF26N1Z-30-00-22	0.350	
				100...250	100...250	0 0	AF26N1Z-30-00-23	0.350	
						0 0	AF26N1Z-30-00-23	0.350	

(1) Only AF..Z contactors with DC control voltage 12...20 V DC need to respect the connection polarities indicated close to the coil terminals: A1+ for the positive pole and A2- for the negative pole.

(2) Available in the US and Canada only.

Main dimensions mm, inches

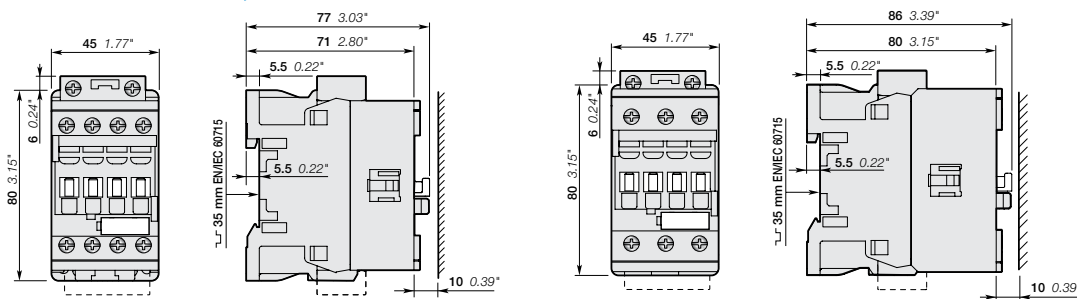

AF09N00Z, AF12N0Z

AF26N1Z

AF40N2 & AF80N3 3-pole NEMA rated contactors

Sizes 2 & 3

AC / DC operated with 1 N.O. + 1 N.C. auxiliary contacts



AF40N2-30-11



AF80N3-30-11

Description

- AF40N2 and AF80N3 NEMA rated contactors are mainly used for controlling 3-phase motor circuits up to 575V AC. These contactors are of the block type design with 3 main poles.
- Control circuit: AC or DC operated with electronic coil interface accepting a wide control voltage range (e.g. 100...250 V AC and DC), only 4 control voltage ranges covering 24...500V 50/60 Hz and 20...500 V DC
- can manage large control voltage variations
- reduced panel energy consumption
- very distinct closing and opening.
- Built-in surge suppression
- Add-on auxiliary contact blocks for front or side mounting and a wide range of accessories.

Ordering details

NEMA				Rated control circuit voltage		Auxiliary contacts fitted	Catalog number	Global reference code (2)	Weight Pkg (1 pce)
Size	Continuous current	3-phase motor rating		Uc min. ... Uc max.					
	A	230 V	460/575V	V 50/60 Hz	V DC				kg
2	45	15	25	24...60	-		1 1	AF40N2-30-11-41	
				24...60	20...60 (1)	1 1	AF40N2-30-11-11		1,010
				48...130	48...130	1 1	AF40N2-30-11-12		1,010
				100...250	100...250	1 1	AF40N2-30-11-13		1,000
3	90	30	50	250...500	250...500	1 1	AF40N2-30-11-14		1,000
				24...60	-	1 1	AF80N3-30-11-41		1,260
				24...60	20...60 (1)	1 1	AF80N3-30-11-11		1,260
				48...130	48...130	1 1	AF80N3-30-11-12		1,260
				100...250	100...250	1 1	AF80N3-30-11-13		1,210
				250...500	250...500	1 1	AF80N3-30-11-14		1,210

(1) AF...-30-...-11 not suitable for direct control by PLC-output.
 (2) Available in the US and Canada only.

Main dimensions mm, inches

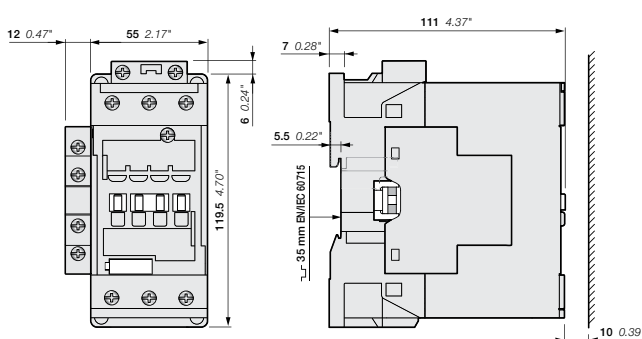

AF40N2

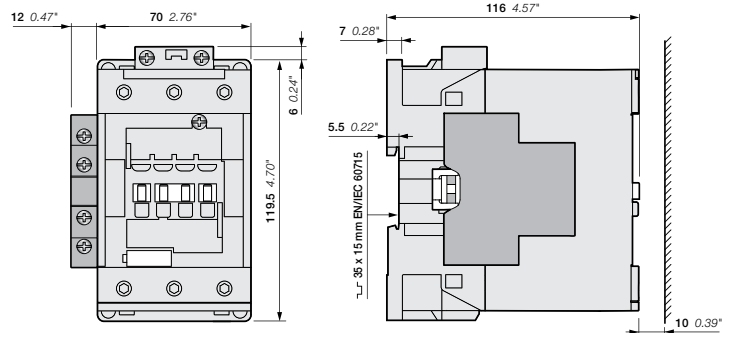

AF80N3

AF140N4 & AF265N5 3-pole NEMA rated contactors

Sizes 4 & 5

AC / DC operated with 1 N.O. + 1 N.C. auxiliary contacts

2



AF140N4-30-11



AF140N4-30-11B



AF265N5-30-11

Description

AF140N4 and AF265N5 NEMA rated contactors are mainly used for controlling 3-phase motor circuits up to 575V AC. These contactors are of the block type design with 3 main poles.

- Control circuit: AC or DC operated with electronic coil interface accepting a wide control voltage range (e.g. 100...250 V AC and DC), only 4 control voltage ranges covering 24...500V 50/60 Hz and 20...500 V DC
- can manage large control voltage variations
- reduced panel energy consumption
- very distinct closing and opening
- can withstand short voltage dips and voltage sags (SEMI F47-0706 conditions of use on request).
- Built-in surge suppression
- Add-on auxiliary contact blocks for side mounting and a wide range of accessories.

Ordering details

NEMA		3-phase motor rating		Rated control circuit voltage		Auxiliary contacts fitted	Catalog number	Global reference code (1)	Weight Pkg (1 pce)
Size	Continuous current	230 V	460/575V	Uc min. ... Uc max.					
	A	hp	hp	V 50/60 Hz	V DC				kg
For connection with built-in cable clamps									
4	135	50	100	24...60	20...60	1 1	AF140N4-30-11-11		1.750
				48...130	48...130	1 1	AF140N4-30-11-12		1.750
				100...250	100...250	1 1	AF140N4-30-11-13		1.750
				250...500	250...500	1 1	AF140N4-30-11-14		1.750
With bar connections									
4	135	50	100	24...60	20...60	1 1	AF140N4-30-11B-11		1.500
				48...130	48...130	1 1	AF140N4-30-11B-12		1.500
				100...250	100...250	1 1	AF140N4-30-11B-13		1.500
				250...500	250...500	1 1	AF140N4-30-11B-14		1.500
5	270	100	200	24...60	20...60	1 1	AF265N5-30-11-11		4.640
				48...130	48...130	1 1	AF265N5-30-11-12		4.640
				100...250	100...250	1 1	AF265N5-30-11-13		4.640
				250...500	250...500	1 1	AF265N5-30-11-14		4.640

(1) Available in the US and Canada only.

Main dimensions mm, inches

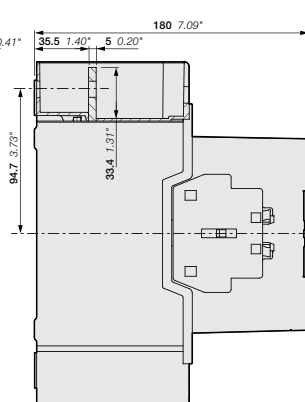
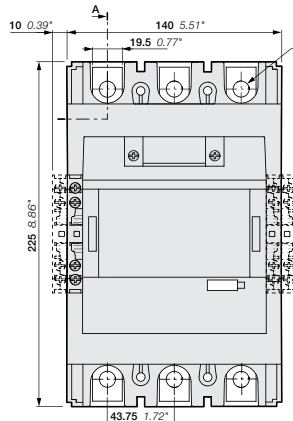
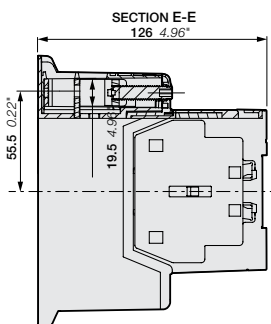
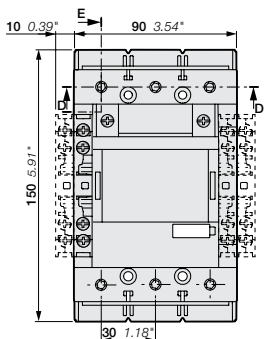

AF140N4

AF265N5

AF460N6 & AF750N7 3-pole NEMA rated contactors

Sizes 6 & 7

AC / DC operated with 1 N.O. + 1 N.C. auxiliary contacts



AF460N6-30-11



AF750N7-30-11

Description

AF460N6 and AF750N7 NEMA rated contactors are mainly used for controlling 3-phase motor circuits up to 575V AC. These contactors are of the block type design with 3 main poles.

- Control circuit: AC or DC operated with electronic coil interface accepting a wide control voltage range (e.g. 100...250 V AC and DC), only 4 coils to cover control voltages between 48...500 V 50/60 Hz and 24...500 V DC
- can manage large control voltage variations
- reduced panel energy consumption
- very distinct closing and opening
- can withstand short voltage dips and voltage sags (SEMI F47-0706 conditions of use on request).
- Built-in surge suppression
- Add-on auxiliary contact blocks for side mounting and a wide range of accessories.

Ordering details

NEMA		3-phase motor rating		Rated control circuit voltage		Auxiliary contacts fitted		Catalog number	Global reference code (2)	Weight
Size	Continuous current	230 V	460/575V	Uc min. ... Uc max.						Pkg (1 pce)
	A	hp	hp	V 50/60 Hz	V DC					kg
6	540	200	400	-	24...60 (1)	1	1	AF460N6-3011-68		12.000
				48...130	48...130	1	1	AF460N6-3011-69		12.000
				100...250	100...250	1	1	AF460N6-3011-70		12.000
				250...500	250...500	1	1	AF460N6-3011-71		12.000
7	810	300	600	-	24...60 (1)	1	1	AF750N7-3011-68		15.000
				48...130	48...130	1	1	AF750N7-3011-69		15.000
				100...250	100...250	1	1	AF750N7-3011-70		15.000
				250...500	250...500	1	1	AF750N7-3011-71		15.000

(1) The connection polarities indicated close to the coil terminals must be respected: A1 for the positive pole and A2 for the negative.
 (2) Available in the US and Canada only.

Control inputs

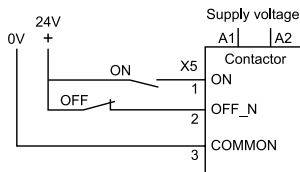

Main dimensions mm, inches

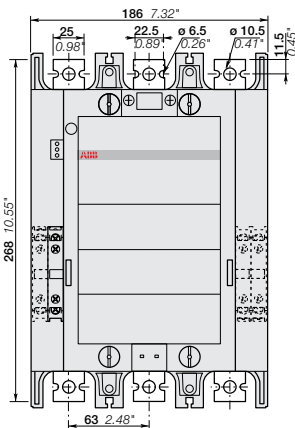

AF460N6

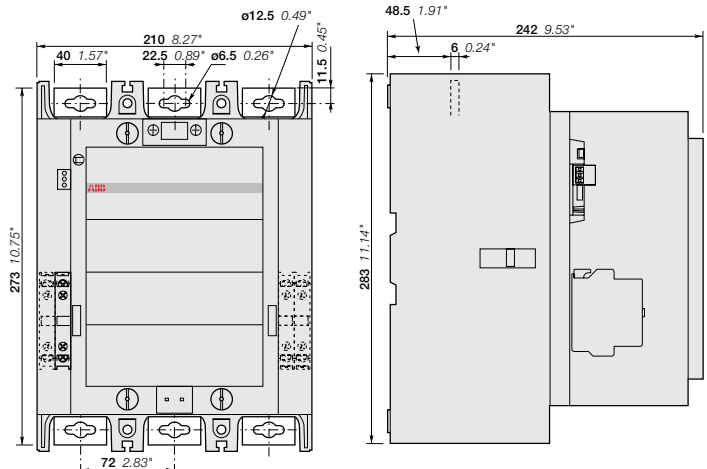
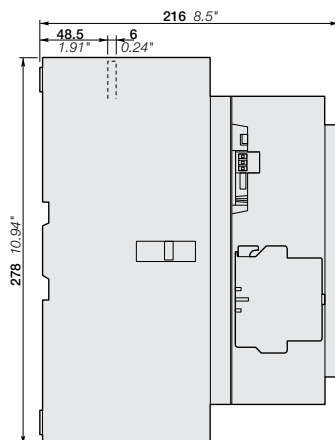

AF750N7

AF09N00R ... AF26N1R 3-pole NEMA rated reversing contactors

Sizes 00 to 1

AC / DC operated



AF09N00R-3022

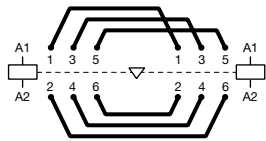

Power bus diagram

Description

AF09N00R ... AF26N1R NEMA rated reversing contactors are mainly used for directionally controlling 3-phase motor circuits up to 575V AC. These devices include two 3-pole contactors, a mechanical and electrical interlock, power bus (see diagram to the left), and are assembled using fixing clips.

Note: for mechanically and electrically interlocked devices without power bus, replace the R in the catalog number with an M (ie. AF09N00R-3022-13 becomes AF09N00M-3022-13).

- control circuit: AC or DC operated with electronic coil interface accepting a wide control voltage range (e.g. 100...250 V AC and DC), only 4 control voltage ranges covering 24...500V 50/60 Hz and 20...500 V DC
- can manage large control voltage variations
- reduced panel energy consumption
- very distinct closing and opening
- built-in surge suppression
- add-on auxiliary contact blocks for front or side mounting and a wide range of accessories

Ordering details

NEMA Size	Continuous current	3-phase motor rating		Rated control circuit voltage		Auxiliary contacts fitted (2)	Catalog number	Global reference code (3)	Weight Pkg (1 pce)
		230V	460/575	V 50/60 Hz	V DC				
00	9	1.5	2	24...60	-	(1)	2 2	AF09N00R-3022-41	0.622
				48...130	48...130		2 2	AF09N00R-3022-12	0.622
				100...250	100...250		2 2	AF09N00R-3022-13	0.622
				250...500	250...500		2 2	AF09N00R-3022-14	0.702
0	18	3	5	24...60	-	(1)	2 2	AF12N0R-3022-41	0.622
				48...130	48...130		2 2	AF12N0R-3022-12	0.622
				100...250	100...250		2 2	AF12N0R-3022-13	0.622
				250...500	250...500		2 2	AF12N0R-3022-14	0.702
1	27	7.5	10	24...60	-	(1)	0 2	AF26N1R-3002-41	0.757
				48...130	48...130		2 2	AF26N1R-3022-41	0.785
				100...250	100...250		0 2	AF26N1R-3002-12	0.757
				250...500	250...500		2 2	AF26N1R-3022-12	0.785
				250...500	250...500		0 2	AF26N1R-3002-13	0.757
				250...500	250...500		2 2	AF26N1R-3022-13	0.785
				250...500	250...500		0 2	AF26N1R-3002-14	0.837
				250...500	250...500		2 2	AF26N1R-3022-14	0.865

(1) For 24...60 V 50/60 Hz - 20...60 V DC, use AF.-30-.-11 (see voltage code table). AF.-30-.-11 not suitable for direct control by PLC-output.
 (2) Normally closed contacts included as part of the electrical interlock. Normally open auxiliaries are either integral or front-mount.
 (3) Available in the US and Canada only.

Mounting dimensions mm, inches

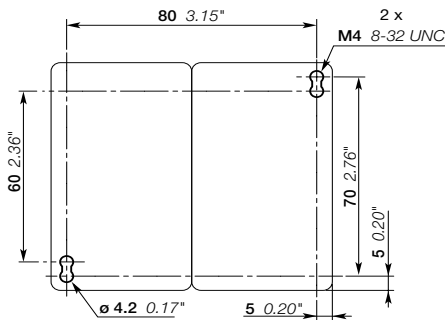

AF09N00R, AF12N0R

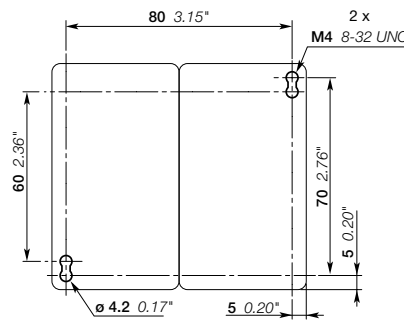

AF26N1R

AF09N00ZR ... AF26N1ZR 3-pole NEMA rated reversing contactors

Sizes 00 to 1

AC / DC operated - low consumption

2



AF09N00ZR-30-22

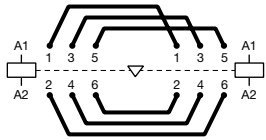

Power bus diagram

Description

AF09N00ZR ... AF26N1ZR NEMA rated reversing contactors are mainly used for directionally controlling 3-phase motor circuits up to 575V AC. These devices include two 3-pole contactors, a mechanical and electrical interlock, power bus (see diagram to the left), and are assembled using fixing clips.

Note: for mechanically and electrically interlocked devices without power bus, replace the R in the catalog number with an M (ie. AF09N00ZR-3022-13 becomes AF09N00ZM-3022-13).

- control circuit: AC or DC operated with electronic coil interface accepting a wide control voltage range (e.g. 100...250 V AC and DC), only 4 control voltage ranges covering 24...250 V 50/60 Hz and 20...250 V DC
- can manage large control voltage variations
- allow direct control by PLC-output ≥ 24 V DC 500 mA
- reduced panel energy consumption
- very distinct closing and opening
- can withstand short voltage dips and voltage sags (SEMI F47-0706 conditions of use on request)
- built-in surge suppression
- add-on auxiliary contact blocks for front or side mounting and a wide range of accessories

Ordering details

NEMA Size	Continuous current	3-phase motor rating		Rated control circuit voltage		Auxiliary contacts fitted (2)	Catalog number	Global reference code (3)	Weight Pkg (1 pce)
		230V	460/575	Uc min. ... Uc max.	Uc min. ... Uc max.				
	A	hp	hp	V 50/60 Hz	V DC				kg
00	9	1.5	2	24...60	20...60	2 2	AF09N00ZR-3022-21		0.702
				48...130	48...130	2 2	AF09N00ZR-3022-22		0.702
				100...250	100...250	2 2	AF09N00ZR-3022-23		0.702
0	18	3	5	24...60	20...60	2 2	AF12N0ZR-3022-21		0.702
				48...130	48...130	2 2	AF12N0ZR-3022-22		0.702
				100...250	100...250	2 2	AF12N0ZR-3022-23		0.702
1	27	7.5	10	24...60	20...60	0 2	AF26N1ZR-3002-21		0.837
						2 2	AF26N1ZR-3022-21		0.865
				48...130	48...130	0 2	AF26N1ZR-3002-22		0.837
						2 2	AF26N1ZR-3022-22		0.865
				100...250	100...250	0 2	AF26N1ZR-3002-23		0.837
						2 2	AF26N1ZR-3022-23		0.865

(1) Normally closed contacts included as part of the electrical interlock. Normally open auxiliaries are either integral or front-mount.

(2) Available in the US and Canada only.

Mounting dimensions mm, inches

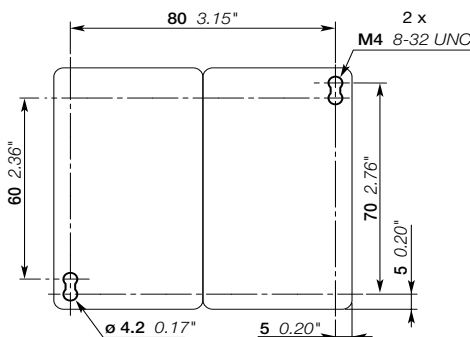

AF09N00ZR, AF12N0ZR

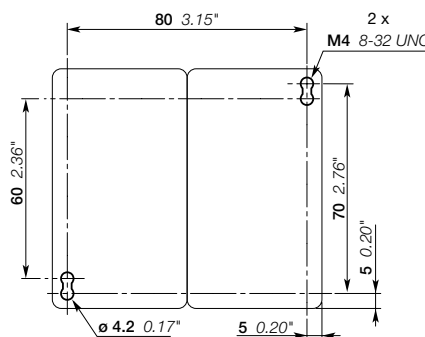

AF26N1ZR

AF40N2R & AF80N3R 3-pole NEMA rated reversing contactors

Sizes 2 & 3

AC / DC operated



AF40N2M-3022

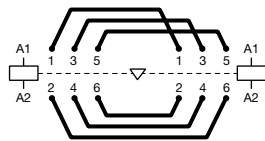

Power bus diagram

Description

AF40N2R and AF80N3R NEMA rated reversing contactors are mainly used for directionally controlling 3-phase motor circuits up to 575V AC. These devices include two 3-pole contactors, a mechanical interlock, side-mounted auxiliary contacts for electrical interlocking, power bus (see diagram to the left), and are assembled using fixing clips.

Note: for mechanically and electrically interlocked devices without power bus, replace the R in the catalog number with an M (ie. AF40N2R-30-22-13 becomes AF40N2M-30-22-13).

- control circuit: AC or DC operated with electronic coil interface accepting a wide control voltage range (e.g. 100...250 V AC and DC), only 4 control voltage ranges covering 24...500V 50/60 Hz and 20...500 V DC
- can manage large control voltage variations
- reduced panel energy consumption
- very distinct closing and opening
- built-in surge suppression
- add-on auxiliary contact blocks for front or side mounting and a wide range of accessories

Ordering details

NEMA Size	Continuous current	3-phase motor rating		Rated control circuit voltage		Auxiliary contacts fitted (2)	Catalog number	Global reference code (3)	Weight Pkg (1 pce)
		230V	460/575	V 50/60 Hz	V DC				
2	45	15	25	24...60	-	2 2	AF40N2R-3022-41		2,283
				24...60	20...60 (1)	2 2	AF40N2R-3022-11		2,283
				48...130	48...130	2 2	AF40N2R-3022-12		2,283
				100...250	100...250	2 2	AF40N2R-3022-13		2,263
				250...500	250...500	2 2	AF40N2R-3022-14		2,263
3	90	30	50	24...60	-	2 2	AF80N3R-3022-41		2,858
				24...60	20...60 (1)	2 2	AF80N3R-3022-11		2,858
				48...130	48...130	2 2	AF80N3R-3022-12		2,858
				100...250	100...250	2 2	AF80N3R-3022-13		2,758
				250...500	250...500	2 2	AF80N3R-3022-14		2,758

(1) AF.-30...-11 not suitable for direct control by PLC-output.
 (2) Normally closed contacts included as part of the electrical interlock. Normally open auxiliaries are either integral or front-mount.
 (3) Available in the US and Canada only.

Mounting dimensions mm, inches

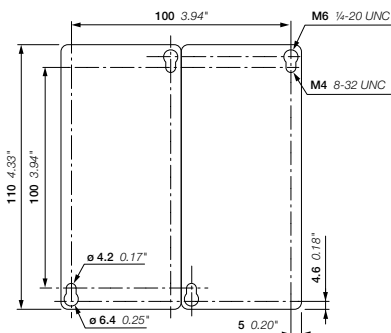

AF40N2R

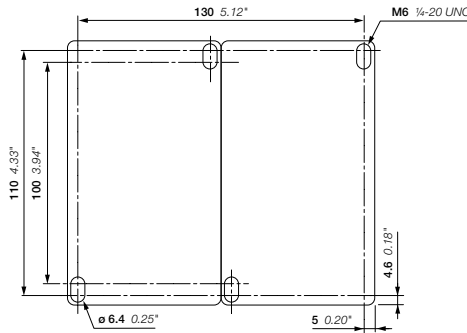

AF80N3R

AF140N4R & AF265N5R 3-pole NEMA rated reversing contactors

Sizes 4 & 5

AC / DC operated

2



AF140N4R-30-22

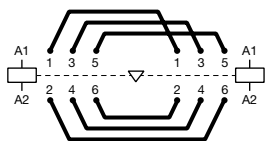

Power bus diagram

Description

AF140N4 and AF265N5 NEMA rated contactors are mainly used for directionally controlling 3-phase motor circuits up to 575V AC. These devices include two 3-pole contactors, a mechanical interlock, side-mounted auxiliary contacts for electrical interlocking, power bus (see diagram to the left), and are mounted on a back-plate.

Note: for mechanically and electrically interlocked devices without power bus, replace the R in the catalog number with an M (ie. AF140N4R-30-22-13 becomes AF140N4M-30-22-13).

- control circuit: AC or DC operated with electronic coil interface accepting a wide control voltage range (e.g. 100...250 V AC and DC), only 4 control voltage ranges covering 24...500V 50/60 Hz and 20...500 V DC
- can manage large control voltage variations
- reduced panel energy consumption
- very distinct closing and opening
- can withstand short voltage dips and voltage sags (SEMI F47-0706 conditions of use on request).
- built-in surge suppression
- add-on auxiliary contact blocks for side mounting and a wide range of accessories

Ordering details

NEMA Size	Continuous current	3-phase motor rating		Rated control circuit voltage Uc min. ... Uc max.		Auxiliary contacts fitted (2)	Catalog number	Global reference code (1)	Weight Pkg (1 pce) kg (2)
		230V	460/575	V 50/60 Hz	V DC				
4	135	50	100	24...60	20...60	2 2	AF140N4R-3022-11		
				48...130	48...130	2 2	AF140N4R-3022-12		
				100...250	100...250	2 2	AF140N4R-3022-13		
				250...500	250...500	2 2	AF140N4R-3022-14		
5	270	100	200	24...60	20...60	2 2	AF265N5R-3022-11		
				48...130	48...130	2 2	AF265N5R-3022-12		
				100...250	100...250	2 2	AF265N5R-3022-13		
				250...500	250...500	2 2	AF265N5R-3022-14		

(1) Available in the US and Canada only.

(2) Available upon request.

Mounting dimensions mm, inches (upon request)

AF460N6 & AF750N7 3-pole NEMA rated reversing contactors

Sizes 6 & 7

AC / DC operated



AF460N6R-11

Description

AF460N6 and AF750N7 NEMA rated contactors are mainly used for directionally controlling 3-phase motor circuits up to 575V AC. These devices include two 3-pole contactors, a mechanical interlock, side-mounted auxiliary contacts for electrical interlocking, power bus (see diagram to the left), and are mounted on a back-plate.

Note: for mechanically and electrically interlocked devices without power bus, replace the R in the catalog number with an M (ie. AF460N6R-11-70 becomes AF460N6M-11-70).

- control circuit: AC or DC operated with electronic coil interface accepting a wide control voltage range (e.g. 100...250 V AC and DC), only 4 coils to cover control voltages between 48...500 V 50/60 Hz and 24...500 V DC
- can manage large control voltage variations
- reduced panel energy consumption
- very distinct closing and opening
- can withstand short voltage dips and voltage sags (SEMI F47-0706 conditions of use on request)
- built-in surge suppression
- add-on auxiliary contact blocks for front or side mounting and a wide range of accessories

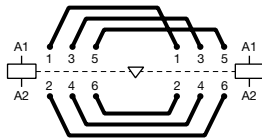

Power bus diagram

Ordering details

NEMA Size	Continuous current	3-phase motor rating		Rated control circuit voltage		Auxiliary contacts fitted (2)	Catalog number	Global reference code (2)	Weight Pkg (1 pce) kg (3)		
		230V	460/575	Uc min. ... Uc max.	Uc min. ... Uc max.						
6	A	200	400	V 50/60 Hz	V DC	2 2	AF460N6R-11-68				
				-	24...60 (1)						
				48...130	48...130					2 2	AF460N6R-11-69
				100...250	100...250					2 2	AF460N6R-11-70
7	810	300	600	V 50/60 Hz	V DC	2 2	AF750N7R-11-68				
				-	24...60 (1)						
				48...130	48...130					2 2	AF750N7R-11-69
				100...250	100...250					2 2	AF750N7R-11-70
				250...500	250...500	2 2	AF750N7R-11-71				

(1) The connection polarities indicated close to the coil terminals must be respected: A1 for the positive pole and A2 for the negative.

(2) Available in the US and Canada only.

(3) Available upon request.

Control inputs

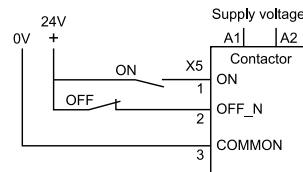

Mounting dimensions mm, inches (upon request)

AF09 ... AF38 4-pole contactors

25 to 55 A general use

AC / DC operated

2



AF09-40-00



AF26-40-00

Description

AF09 ... AF38 4-pole contactors are mainly used for controlling non-inductive or slightly inductive loads (i.e. resistance furnaces...) and generally for controlling power circuits up to 690 V AC and 440 V DC. These contactors are of the block type design with 4 main poles.

- control circuit: AC or DC operated with electronic coil interface accepting a wide control voltage range (e.g. 100...250 V AC and DC), only 4 control voltage ranges covering 24...500 V 50/60 Hz and 20...500 V DC
- can manage large control voltage variations
- reduced panel energy consumption
- very distinct closing and opening
- built-in surge suppression
- add-on auxiliary contact blocks for front or side mounting and a wide range of accessories

Ordering details

IEC	UL/CSA	Rated control circuit voltage Uc min. ... Uc max.		Auxiliary contacts fitted	Catalog number	Global reference code	Weight	
Rated operational current $\theta \leq 40^\circ\text{C}$ AC-1	General use rating 600 V AC	V 50/60 Hz	V DC				Pkg (1 pce) kg	
4 N.O. main poles								
25	25	24...60	-	(1)	0 0	AF09-40-00-41	1SBL137201R4100	0.270
		48...130	48...130		0 0	AF09-40-00-12	1SBL137201R1200	0.270
		100...250	100...250		0 0	AF09-40-00-13	1SBL137201R1300	0.270
		250...500	250...500		0 0	AF09-40-00-14	1SBL137201R1400	0.310
30	30	24...60	-	(1)	0 0	AF16-40-00-41	1SBL177201R4100	0.270
		48...130	48...130		0 0	AF16-40-00-12	1SBL177201R1200	0.270
		100...250	100...250		0 0	AF16-40-00-13	1SBL177201R1300	0.270
		250...500	250...500		0 0	AF16-40-00-14	1SBL177201R1400	0.310
45	45	24...60	-	(1)	0 0	AF26-40-00-41	1SBL237201R4100	0.360
		48...130	48...130		0 0	AF26-40-00-12	1SBL237201R1200	0.360
		100...250	100...250		0 0	AF26-40-00-13	1SBL237201R1300	0.360
		250...500	250...500		0 0	AF26-40-00-14	1SBL237201R1400	0.400
55	55	24...60	-	(1)	0 0	AF38-40-00-41	1SBL297201R4100	0.360
		48...130	48...130		0 0	AF38-40-00-12	1SBL297201R1200	0.360
		100...250	100...250		0 0	AF38-40-00-13	1SBL297201R1300	0.360
		250...500	250...500		0 0	AF38-40-00-14	1SBL297201R1400	0.400
2 N.O. + 2 N.C. main poles								
25	25	24...60	-	(1)	0 0	AF09-22-00-41	1SBL137501R4100	0.270
		48...130	48...130		0 0	AF09-22-00-12	1SBL137501R1200	0.270
		100...250	100...250		0 0	AF09-22-00-13	1SBL137501R1300	0.270
		250...500	250...500		0 0	AF09-22-00-14	1SBL137501R1400	0.310
30	30	24...60	-	(1)	0 0	AF16-22-00-41	1SBL177501R4100	0.270
		48...130	48...130		0 0	AF16-22-00-12	1SBL177501R1200	0.270
		100...250	100...250		0 0	AF16-22-00-13	1SBL177501R1300	0.270
		250...500	250...500		0 0	AF16-22-00-14	1SBL177501R1400	0.310
45	45	24...60	-	(1)	0 0	AF26-22-00-41	1SBL237501R4100	0.360
		48...130	48...130		0 0	AF26-22-00-12	1SBL237501R1200	0.360
		100...250	100...250		0 0	AF26-22-00-13	1SBL237501R1300	0.360
		250...500	250...500		0 0	AF26-22-00-14	1SBL237501R1400	0.400
55	55	24...60	-	(1)	0 0	AF38-22-00-41	1SBL297501R4100	0.360
		48...130	48...130		0 0	AF38-22-00-12	1SBL297501R1200	0.360
		100...250	100...250		0 0	AF38-22-00-13	1SBL297501R1300	0.360
		250...500	250...500		0 0	AF38-22-00-14	1SBL297501R1400	0.400

(1) For 24...60 V 50/60 Hz - 20...60 V DC, use AF-...-11 (see voltage code table). AF-...-11 not suitable for direct control by PLC-output.

Main dimensions mm, inches

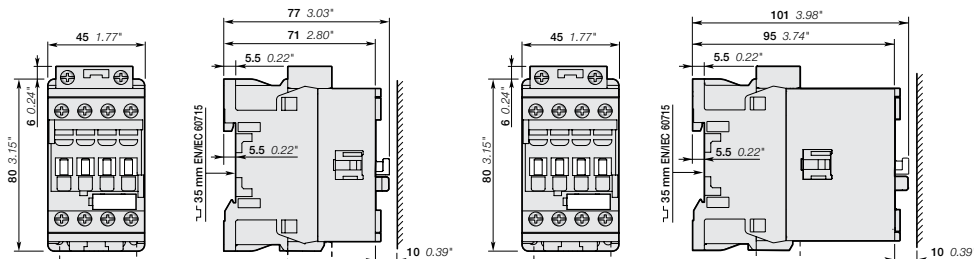

AF09, AF16

AF26, AF38

AF09Z ... AF38Z 4-pole contactors

25 to 55 A general use

AC / DC operated - low consumption



AF09Z-40-00



AF26Z-40-00

Description

AF09Z ... AF38Z 4-pole contactors are mainly used for controlling non-inductive or slightly inductive loads (i.e. resistance furnaces...) and generally for controlling power circuits up to 690 V AC and 440 V DC. These contactors are of the block type design with 4 main poles.

- control circuit: AC or DC operated with electronic coil interface accepting a wide control voltage range (e.g. 100...250 V AC and DC), only 4 control voltage ranges covering 24...250 V 50/60 Hz and 12...250 V DC
- can manage large control voltage variations
- allow direct control by PLC-output ≥ 24 V DC 500 mA
- reduced panel energy consumption
- very distinct closing and opening
- can withstand short voltage dips and voltage sags (SEMI F47-0706 conditions of use on request).
- built-in surge suppression
- add-on auxiliary contact blocks for front or side mounting and a wide range of accessories.

Ordering details

IEC Rated operational current ≤ 40 °C AC-1 A	UL/CSA General use rating 600 V AC A	Rated control circuit voltage Uc min. ... Uc max.		Auxiliary contacts fitted 	Catalog number	Global reference code	Weight Pkg (1 pce) kg
		V 50/60 Hz	V DC				
4 N.O. main poles							
25	25	-	12...20	0 0	AF09Z-40-00-20	1SBL136201R2000	0.310
		24...60	20...60	0 0	AF09Z-40-00-21	1SBL136201R2100	0.310
		48...130	48...130	0 0	AF09Z-40-00-22	1SBL136201R2200	0.310
		100...250	100...250	0 0	AF09Z-40-00-23	1SBL136201R2300	0.310
30	30	-	12...20	0 0	AF16Z-40-00-20	1SBL176201R2000	0.310
		24...60	20...60	0 0	AF16Z-40-00-21	1SBL176201R2100	0.310
		48...130	48...130	0 0	AF16Z-40-00-22	1SBL176201R2200	0.310
		100...250	100...250	0 0	AF16Z-40-00-23	1SBL176201R2300	0.310
45	45	-	12...20	0 0	AF26Z-40-00-20	1SBL236201R2000	0.400
		24...60	20...60	0 0	AF26Z-40-00-21	1SBL236201R2100	0.400
		48...130	48...130	0 0	AF26Z-40-00-22	1SBL236201R2200	0.400
		100...250	100...250	0 0	AF26Z-40-00-23	1SBL236201R2300	0.400
55	55	-	12...20	0 0	AF38Z-40-00-20	1SBL296201R2000	0.400
		24...60	20...60	0 0	AF38Z-40-00-21	1SBL296201R2100	0.400
		48...130	48...130	0 0	AF38Z-40-00-22	1SBL296201R2200	0.400
		100...250	100...250	0 0	AF38Z-40-00-23	1SBL296201R2300	0.400
2 N.O. + 2 N.C. main poles							
25	25	-	12...20	0 0	AF09Z-22-00-20	1SBL136501R2000	0.310
		24...60	20...60	0 0	AF09Z-22-00-21	1SBL136501R2100	0.310
		48...130	48...130	0 0	AF09Z-22-00-22	1SBL136501R2200	0.310
		100...250	100...250	0 0	AF09Z-22-00-23	1SBL136501R2300	0.310
30	30	-	12...20	0 0	AF16Z-22-00-20	1SBL176501R2000	0.310
		24...60	20...60	0 0	AF16Z-22-00-21	1SBL176501R2100	0.310
		48...130	48...130	0 0	AF16Z-22-00-22	1SBL176501R2200	0.310
		100...250	100...250	0 0	AF16Z-22-00-23	1SBL176501R2300	0.310
45	45	-	12...20	0 0	AF26Z-22-00-20	1SBL236501R2000	0.400
		24...60	20...60	0 0	AF26Z-22-00-21	1SBL236501R2100	0.400
		48...130	48...130	0 0	AF26Z-22-00-22	1SBL236501R2200	0.400
		100...250	100...250	0 0	AF26Z-22-00-23	1SBL236501R2300	0.400
55	55	-	12...20	0 0	AF38Z-22-00-20	1SBL296501R2000	0.400
		24...60	20...60	0 0	AF38Z-22-00-21	1SBL296501R2100	0.400
		48...130	48...130	0 0	AF38Z-22-00-22	1SBL296501R2200	0.400
		100...250	100...250	0 0	AF38Z-22-00-23	1SBL296501R2300	0.400

Note: Only AF.Z contactors with DC control voltage 12...20 V DC need to respect the connection polarities indicated close to the coil terminals: A1+ for the positive pole and A2- for the negative pole.

Main dimensions mm, inches

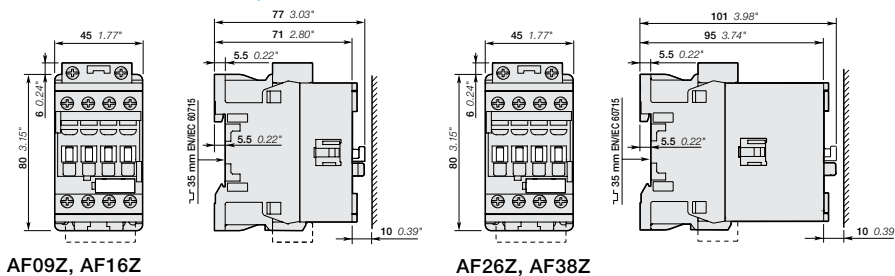

NF 4-pole control relays

Pilot duty rated A600 / Q600

AC / DC operated

2



NF22E

Description

NF control relays are used for switching auxiliary and control circuits.

These control relays are of the block type design with:

- 4 poles. Control relays have mechanically linked auxiliary contact elements (side-marked symbol)
- control circuit: AC or DC operated with electronic coil interface accepting a wide control voltage range (e.g. 100...250 V AC and DC)
 - can manage large control voltage variations
 - only 4 control voltage ranges covering 24...500 V 50/60 Hz and 20...500 V DC
 - reduced panel energy consumption
 - very distinct closing and opening
- built-in surge suppression
- add-on auxiliary contact blocks for front or side mounting and a wide range of accessories

Ordering details

Number of contacts	Rated control circuit voltage		Catalog number	Global reference code	Weight Pkg (1 pce) kg	
	Uc min. ... Uc max.					
	V 50/60 Hz	V DC				
	24...60	-	(1)	NF22E-41	1SBH137001R4122	0.270
	48...130	48...130		NF22E-12	1SBH137001R1222	0.270
	100...250	100...250		NF22E-13	1SBH137001R1322	0.270
	250...500	250...500		NF22E-14	1SBH137001R1422	0.310
	24...60	-	(1)	NF31E-41	1SBH137001R4131	0.270
	48...130	48...130		NF31E-12	1SBH137001R1231	0.270
	100...250	100...250		NF31E-13	1SBH137001R1331	0.270
	250...500	250...500		NF31E-14	1SBH137001R1431	0.310
	24...60	-	(1)	NF40E-41	1SBH137001R4140	0.270
	48...130	48...130		NF40E-12	1SBH137001R1240	0.270
	100...250	100...250		NF40E-13	1SBH137001R1340	0.270
	250...500	250...500		NF40E-14	1SBH137001R1440	0.310

(1) For 24...60 V 50/60 Hz - 20...60 V DC, use NF..E-11 (see voltage code table). NF..E-11 not suitable for direct control by PLC-output.

Main dimensions mm, inches

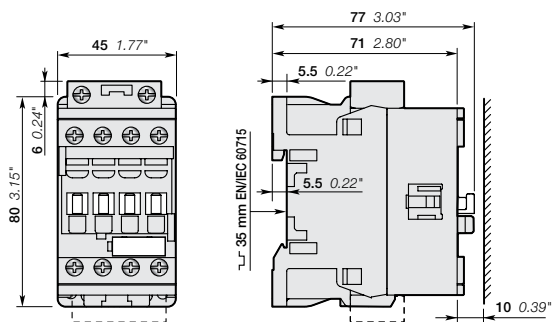

NF22E, NF31E, NF40E

NFZ 4-pole control relays

Pilot duty rated A600 / Q600

AC / DC operated - low consumption



NFZ22E

Description

NFZ control relays are used for switching auxiliary and control circuits.

These control relays are of the block type design with:

- 4 poles. Control relays have mechanically linked auxiliary contact elements (side-marked symbol)
- control circuit: AC or DC operated with electronic coil interface accepting a wide control voltage range (e.g. 100...250 V AC and DC)
 - can manage large control voltage variations
 - only 4 control voltage ranges covering 24...250 V 50/60 Hz and 12...250 V DC
 - allow direct control by PLC-output ≥ 24 V DC 500 mA
 - reduced panel energy consumption
 - very distinct closing and opening
 - can withstand short voltage dips and voltage sags (SEMI F47-0706 conditions of use on request).
- built-in surge suppression
- add-on auxiliary contact blocks for front or side mounting and a wide range of accessories.

Ordering details

Number of contacts	Rated control circuit voltage Uc min. ... Uc max.		Catalog number	Global reference code	Weight Pkg (1 pce) kg
	V 50/60 Hz	V DC			
	-	12...20	NFZ22E-20	1SBH136001R2022	0.310
	24...60	20...60	NFZ22E-21	1SBH136001R2122	0.310
	48...130	48...130	NFZ22E-22	1SBH136001R2222	0.310
	100...250	100...250	NFZ22E-23	1SBH136001R2322	0.310
	-	12...20	NFZ31E-20	1SBH136001R2031	0.310
	24...60	20...60	NFZ31E-21	1SBH136001R2131	0.310
	48...130	48...130	NFZ31E-22	1SBH136001R2231	0.310
	100...250	100...250	NFZ31E-23	1SBH136001R2331	0.310
	-	12...20	NFZ40E-20	1SBH136001R2040	0.310
	24...60	20...60	NFZ40E-21	1SBH136001R2140	0.310
	48...130	48...130	NFZ40E-22	1SBH136001R2240	0.310
	100...250	100...250	NFZ40E-23	1SBH136001R2340	0.310

Note: Only NFZ contactor relays with DC control voltage 12...20 V DC need to respect the connection polarities indicated close to the coil terminals: A1+ for the positive pole and A2- for the negative pole.

Main dimensions mm, inches

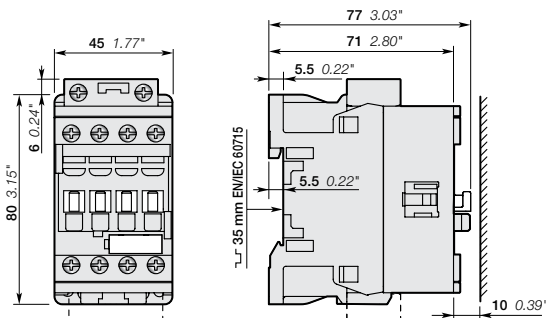

NFZ22E, NFZ31E, NFZ40E

NF 8-pole control relays

Pilot duty rated A600 / Q600

AC / DC operated

2



NF44E

Description

NF control relays are used for switching auxiliary and control circuits.

These control relays are of the block type design with:

- 8 poles with a permanently fixed 4-pole auxiliary contact block. Control relays have mechanically linked auxiliary contact elements (side-marked symbol)
- control circuit: AC or DC operated with electronic coil interface accepting a wide control voltage range (e.g. 100...250 V AC and DC)
 - can manage large control voltage variations
 - only 4 control voltage ranges covering 24...500 V 50/60 Hz and 20...500 V DC
 - reduced panel energy consumption
 - very distinct closing and opening
- built-in surge suppression
- add-on auxiliary contact blocks for side mounting and a wide range of accessories

Ordering details

Number of contacts		Rated control circuit voltage		Catalog number	Global reference code	Weight Pkg (1 pce) kg
1st stack	2nd stack	Uc min. ... Uc max.				
		V 50/60 Hz	V DC			
		24...60	- (1)	NF44E-41	1SBH137001R4144	0.320
		48...130	48...130	NF44E-12	1SBH137001R1244	0.320
		100...250	100...250	NF44E-13	1SBH137001R1344	0.320
		250...500	250...500	NF44E-14	1SBH137001R1444	0.360
		24...60	- (1)	NF53E-41	1SBH137001R4153	0.320
		48...130	48...130	NF53E-12	1SBH137001R1253	0.320
		100...250	100...250	NF53E-13	1SBH137001R1353	0.320
		250...500	250...500	NF53E-14	1SBH137001R1453	0.360
		24...60	- (1)	NF62E-41	1SBH137001R4162	0.320
		48...130	48...130	NF62E-12	1SBH137001R1262	0.320
		100...250	100...250	NF62E-13	1SBH137001R1362	0.320
		250...500	250...500	NF62E-14	1SBH137001R1462	0.360
		24...60	- (1)	NF71E-41	1SBH137001R4171	0.320
		48...130	48...130	NF71E-12	1SBH137001R1271	0.320
		100...250	100...250	NF71E-13	1SBH137001R1371	0.320
		250...500	250...500	NF71E-14	1SBH137001R1471	0.360
		24...60	- (1)	NF80E-41	1SBH137001R4180	0.320
		48...130	48...130	NF80E-12	1SBH137001R1280	0.320
		100...250	100...250	NF80E-13	1SBH137001R1380	0.320
		250...500	250...500	NF80E-14	1SBH137001R1480	0.360

(1) For 24...60 V 50/60 Hz - 20...60 V DC, use NF.E-11 (see voltage code table). NF.E-11 not suitable for direct control by PLC-output.

Main dimensions mm, inches

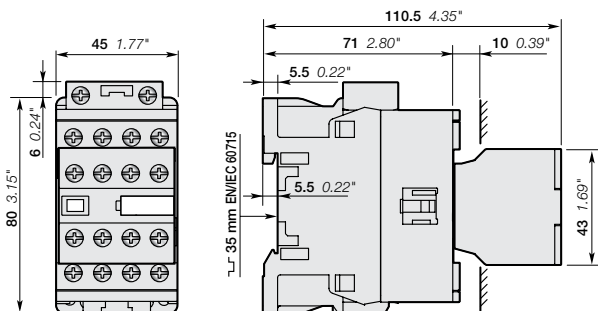

NF44E, NF53E, NF62E, NF71E, NF80E

NFZ 8-pole control relays

Pilot duty rated A600 / Q600

AC / DC operated – Low consumption



NFZ44E

Description

NFZ control relays are used for switching auxiliary and control circuits.

These control relays are of the block type design with:

- 8 poles with a permanently fixed 4-pole auxiliary contact block. Control relays have mechanically linked auxiliary contact elements (side-marked symbol)
- control circuit: AC or DC operated with electronic coil interface accepting a wide control voltage range (e.g. 100...250 V AC and DC)
 - can manage large control voltage variations
 - only 4 control voltage ranges covering 24...250 V 50/60 Hz and 12...250 V DC
 - allow direct control by PLC-output ≥ 24 VDC 500 mA
 - reduced panel energy consumption
 - very distinct closing and opening
 - can withstand short voltage dips and voltage sags (SEMI F47-0706 conditions of use on request)
- built-in surge suppression
- add-on auxiliary contact blocks for side mounting and a wide range of accessories

Ordering details

Number of contacts		Rated control circuit voltage Uc min. ... Uc max.	Catalog number	Global reference code	Weight kg Pkg (1 pce)	
1st stack	2nd stack					
		V 50/60 Hz	V DC			
		-	12...20	NFZ44E-20	1SBH136001R2044	0.360
		24...60	20...60	NFZ44E-21	1SBH136001R2144	0.360
		48...130	48...130	NFZ44E-22	1SBH136001R2244	0.360
		-	12...20	NFZ53E-20	1SBH136001R2053	0.360
		24...60	20...60	NFZ53E-21	1SBH136001R2153	0.360
		48...130	48...130	NFZ53E-22	1SBH136001R2253	0.360
		100...250	100...250	NFZ53E-23	1SBH136001R2353	0.360
		-	12...20	NFZ62E-20	1SBH136001R2062	0.360
		24...60	20...60	NFZ62E-21	1SBH136001R2162	0.360
		48...130	48...130	NFZ62E-22	1SBH136001R2262	0.360
		100...250	100...250	NFZ62E-23	1SBH136001R2362	0.360
		-	12...20	NFZ71E-20	1SBH136001R2071	0.360
		24...60	20...60	NFZ71E-21	1SBH136001R2171	0.360
		48...130	48...130	NFZ71E-22	1SBH136001R2271	0.360
		100...250	100...250	NFZ71E-23	1SBH136001R2371	0.360
		-	12...20	NFZ80E-20	1SBH136001R2080	0.360
		24...60	20...60	NFZ80E-21	1SBH136001R2180	0.360
		48...130	48...130	NFZ80E-22	1SBH136001R2280	0.360
		100...250	100...250	NFZ80E-23	1SBH136001R2380	0.360

Note: Only NFZ contactor relays with DC control voltage 12...20 V DC need to respect the connection polarities indicated close to the coil terminals: A1+ for the positive pole and A2- for the negative pole.

Main dimensions mm, inches

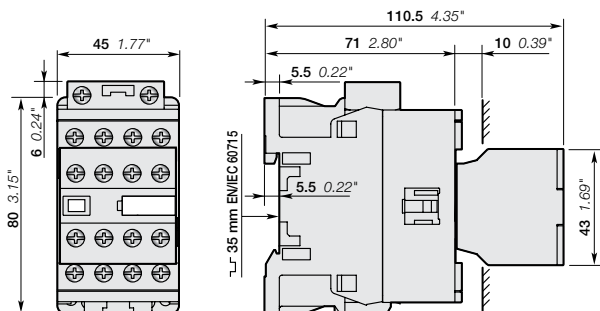

NFZ44E, NFZ53E, NFZ62E, NFZ71E, NFZ80E

Voltage code table

The below tables indicate the available coil voltages and corresponding digits for catalog numbers. When placing an order, please give the catalog number. Select a standard contactor from ordering detail pages. Change the coil voltage code in the catalog number according to the table below.

Example: for contactor AF400-30-11 and coil 100...250 V 50/60 Hz, the catalog number is AF400-30-11-70.

2 AF09 ... AF370 3-pole contactors AF09 ... AF38 4-pole contactors

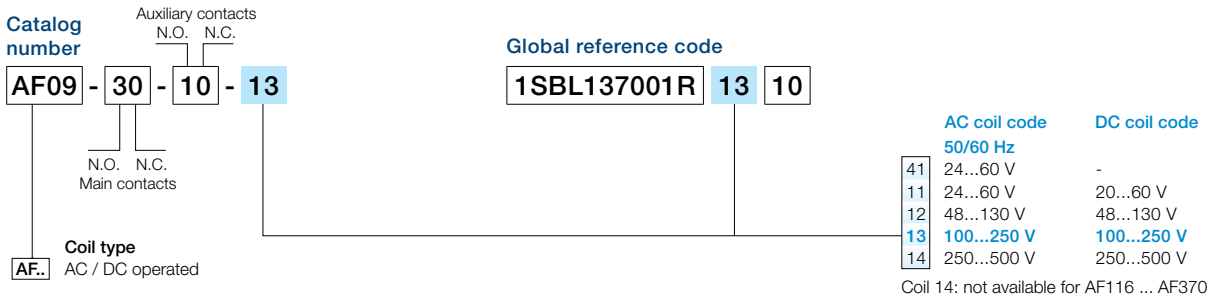

AF400 ... AF2650 3-pole contactors

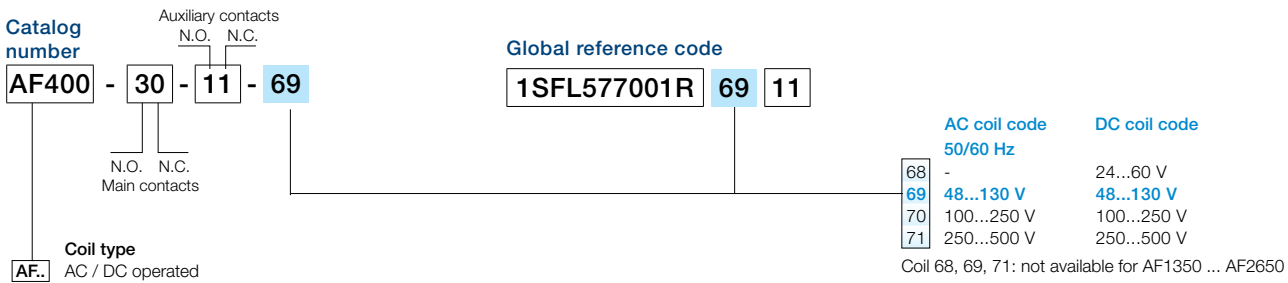

AF09 ... AF38 3- and 4-pole contactors - low consumption

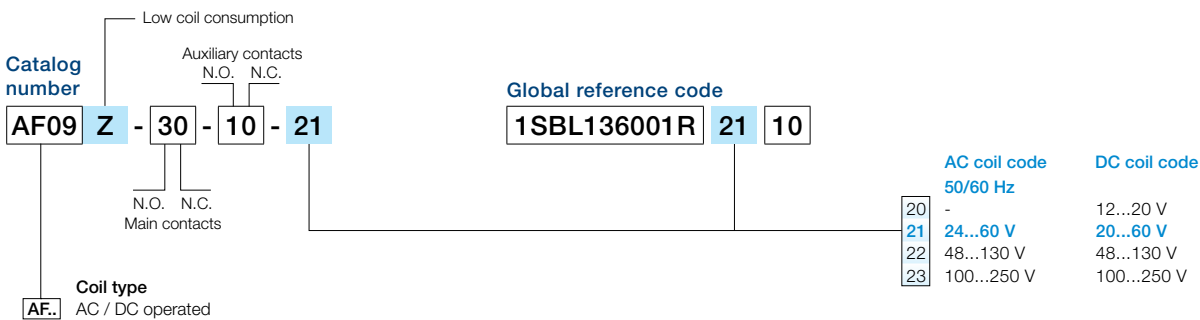

Voltage code table

NF control relays

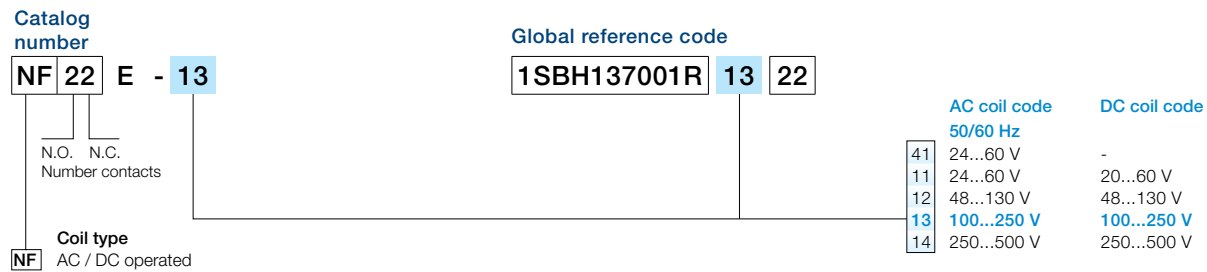

NF control relays - low consumption

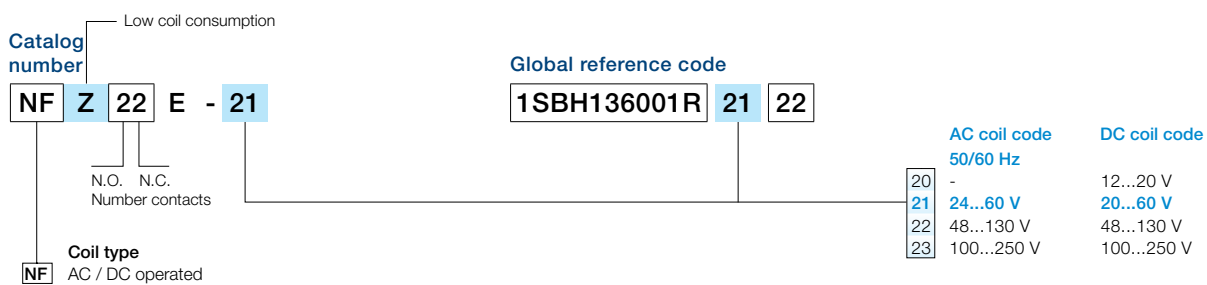

AF09 ... AF96 3-pole contactors

Accessory fitting details

Contactor and main accessories (other accessories available)

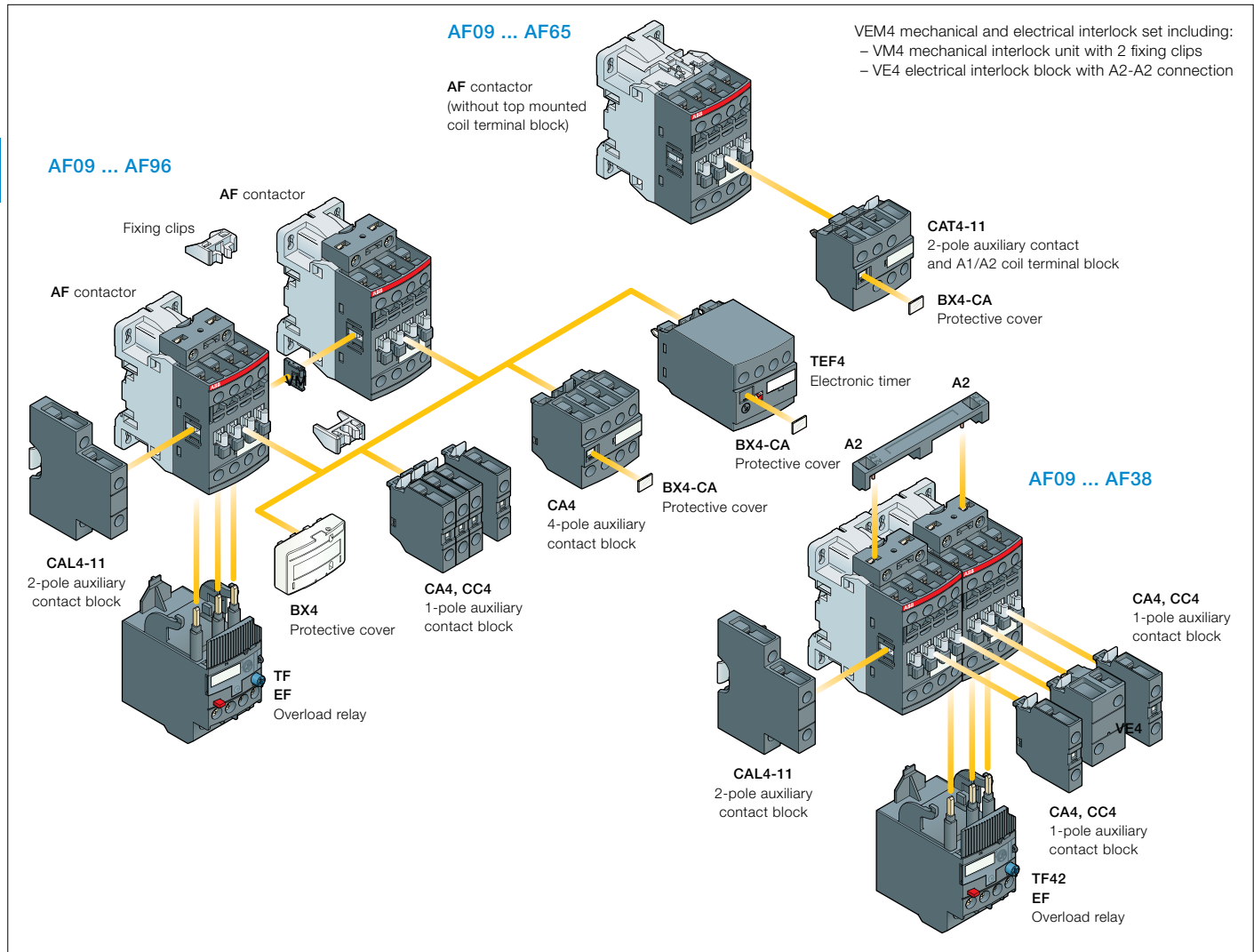

Main accessory fitting details

Many configurations of accessories are possible depending on whether these are front-mounted or side-mounted.

Contactor types	Main poles	Built-in auxiliary contacts	Front-mounted accessories				Side-mounted accessories			
			Auxiliary contact blocks			Electronic timer	Electrical and mechanical interlock set (between 2 contactors)	Auxiliary contact blocks		
			1-pole CA4	2-pole CAT4-11	4-pole CA4	TEF4	VEM4	Left side	Right side	
			1-pole CC4					2-pole CAL4-11		
			Max. N.C. built-in and add-on N.C. auxiliary contacts: 4 N.C. max. on positions 1, 2, 3, 4 and 3 N.C. max. on positions 1 ±30°, 5							
AF09 ... AF16	3	0	0	1	4 max.	or 1	or 1	–	+ 1	–
AF09 ... AF16	3	0	1	0	2 max.	or 1	–	–	+ 1	+ 1
AF26 ... AF38	3	0	0	0	3 max.	–	–	+ 1	+ 1	or 1
AF40 ... AF65	3	0	0	0	4 max.	or 1	or 1	–	+ 1	+ 1
AF80, AF96	3	0	0	0	4 max.	–	or 1	–	+ 1	+ 1

Overload relays fitting details (1)

Contactor types	Thermal overload relays	Electronic overload relays
AF09 ... AF38	TF42 (0.10...38 A)	EF19 (0.10...19 A)
AF26 ... AF38	TF42 (0.10...38 A)	EF45 (9...45 A)
AF40 ... AF65	TF65 (22...67 A)	EF65 (25...70 A)
AF80, AF96	TF96 (40...96 A)	EF96 (36...100 A)

The addition of an overload relay on the contactor does not prevent fitting of many other accessories as shown above.

(1) Direct mounting - No kit required.



AF09 ... AF96 3-pole contactors

Accessory fitting details

For AF09 ... AF38 contactors + CE5 auxiliary contacts for severe industrial environments

Main accessory fitting details

Many configurations of accessories are possible depending on whether these are front-mounted or side-mounted.

Contactor types	Main poles 	Built-in auxiliary contacts 	Front-mounted accessories			Side-mounted accessories		
			Auxiliary contact blocks			Electronic timer mechanical interlock set (between 2 contactors) VEM4	Auxiliary contact blocks	
			1-pole CE5	1-pole CA4 1-pole CC4		Left side 2-pole CAL4-11	Right side	

3-pole contactors AF09 ... AF38

Max. N.C. built-in and add-on N.C. auxiliary contacts (CA4, CC4, CAL4, VEM4):
2 max. with 1 CE5, none with 2 CE5 on positions 1, 2, 3, 4

AF09 ... AF16	3 0	0 1	1	+	3 max.	-	+	1	-
AF09 ... AF16	3 0	1 0	2	+	2 max.	-	-	-	-
AF26 ... AF38	3 0	0 0	1	+	3 max.	-	+	1	-
			1	+	1 max.	-	+	1	+ 1
			1	+	2 max.	+	1	+	1
1 max. N.C. built-in and add-on N.C. auxiliary contacts (CA4, CC4, CAL4, VEM4) on positions 1 ±30°, 5									
AF09 ... AF16	3 0	0 1	1	+	3 max.	-	-	-	-
AF09 ... AF16	3 0	1 0	1	+	3 max.	-	+	1	-
AF26 ... AF38	3 0	0 0	1	+	2 max.	+	1	-	-

4-pole contactors AF09 ... AF38

Max. add-on N.C. auxiliary contacts (CA4, CC4, CAL4, VEM4):
2 max. with 1 CE5, none with 2 CE5 on positions 1, 2, 3, 4

AF09, AF16	4 0	0 0	2	+	2 max.	-	-	-	-	
			1	+	3 max.	-	+	1	-	
			1	+	1 max.	-	+	1	+ 1	-
			1	+	2 max.	+	1	+	1	-
1 max. add-on N.C. auxiliary contacts (CA4, CC4, CAL4, VEM4) on positions 1, 2, 3, 4										
AF26, AF38	4 0	0 0	1	+	3 max.	-	+	1	-	
			1	+	2 max.	+	1	-	-	
AF09, AF16	2 2	0 0	1	+	3 max.	-	+	1	-	
AF26, AF38	2 2	0 0								
1 max. add-on N.C. auxiliary contacts (CA4, CC4, CAL4, VEM4) on positions 1 ±30°, 5										
AF09, AF16	4 0	0 0	1	+	3 max.	-	+	1	-	
			1	+	2 max.	+	1	-	-	
No add-on N.C. auxiliary contacts on positions 1 ±30°, 5										
AF26, AF38	4 0	0 0	1	+	3 max.	-	-	-	-	
AF09, AF16	2 2	0 0								
AF26, AF38	2 2	0 0								

AF116 ... AF370 3-pole contactors with 1 N.O. + 1 N.C. auxiliary contacts

Accessory fitting details

Main accessories (other accessories available)

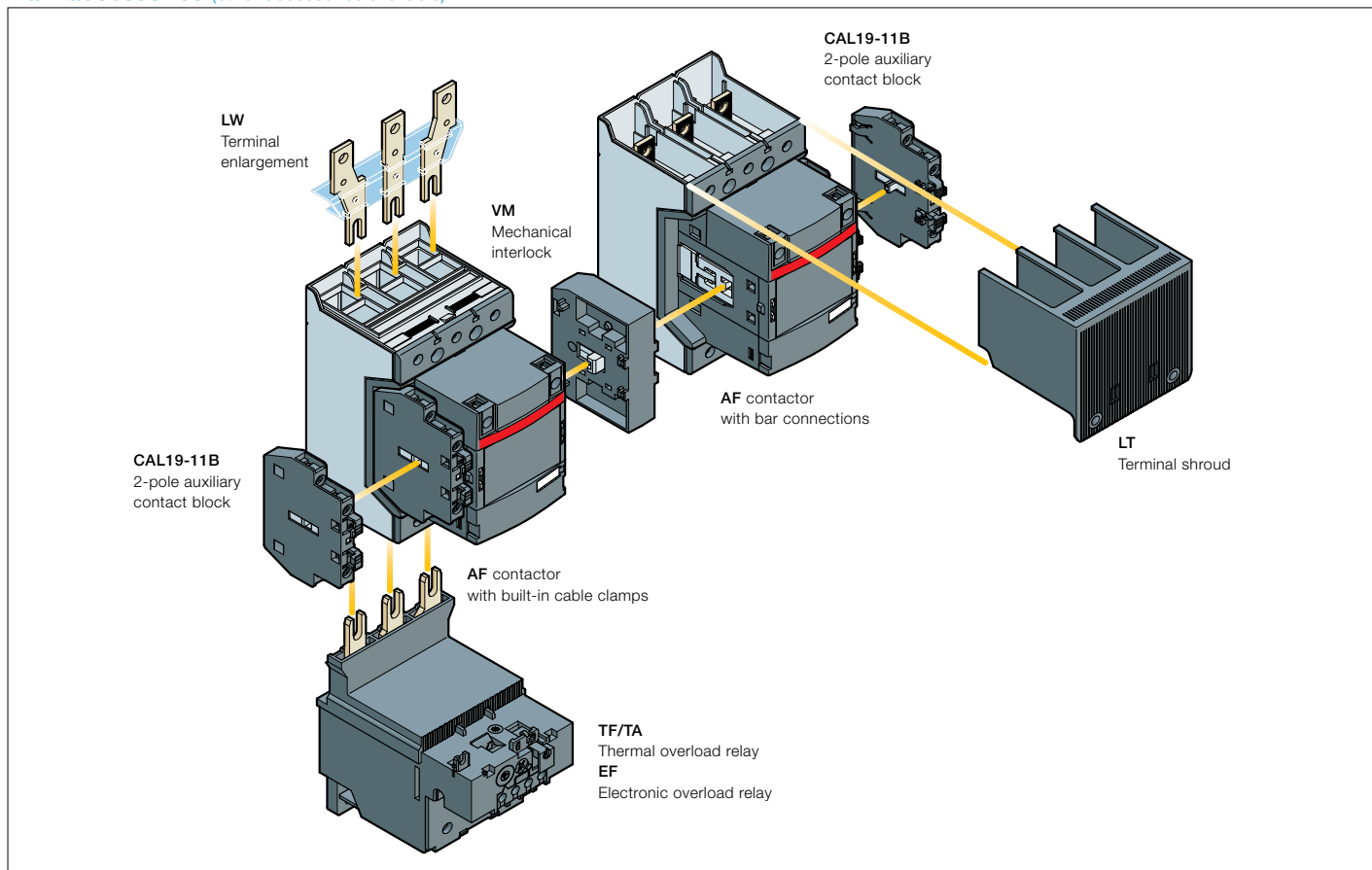

Main accessory fitting details

Contactor types	Main poles	Available auxiliary contacts	Side-mounted accessories		
			Auxiliary contact blocks		Mechanical interlock units (between two contactors)
			CAL19-11	CAL19-11B	
AF116 ... AF370	3	0 1 1	1 x CAL19-11	+ 2 x CAL19-11B	-
AF116 ... AF370	3	0 1 1	-	+ 2 x CAL19-11B (1)	+ VM... (2)

(1) Total number of auxiliary contact blocks for the two contactors.

(2) Interlock type, according to the contactor ratings (see "Accessories").

Overload relays fitting details (1)

Contactor types	Thermal overload relays	Electronic overload relays
AF116 ... AF140	TF140DU (66...142 A)	EF146 (54...150 A)
AF146	-	EF146 (54...150 A)
AF190, AF205	TA200DU (66...200 A)	EF205 (63...210 A)
AF265 ... AF370	-	EF370 (115...380 A)

The addition of a thermal or electronic overload relay on the contactor does not prevent fitting of many other accessories as shown in "Main accessory fitting details" table.

(1) Direct mounting - No kit required.

AF400 ... AF2650 3-pole contactors with 1 N.O. + 1 N.C. auxiliary contacts Accessory fitting details

Main accessories (other accessories available)

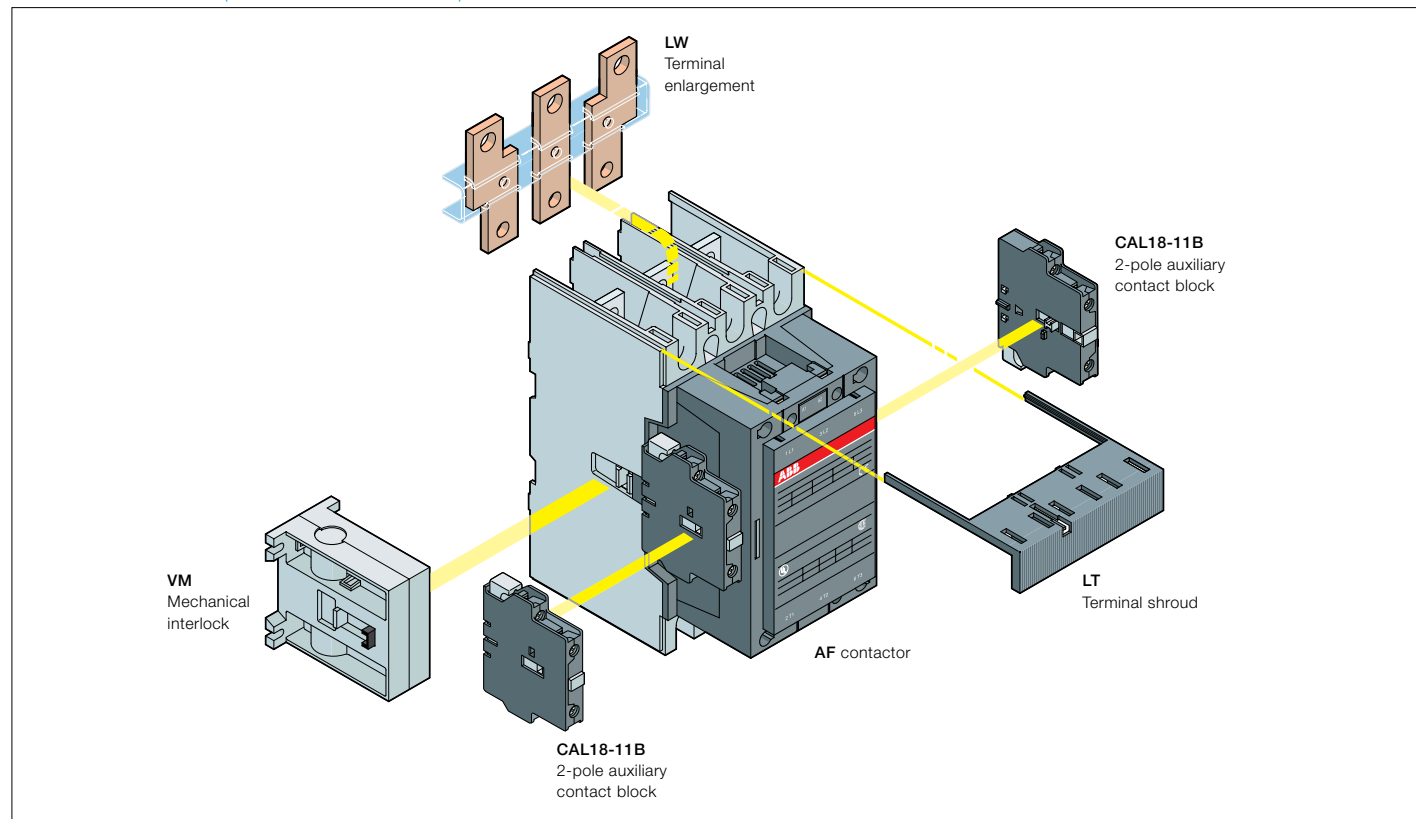

Main accessory fitting details

Contactor types	Main poles	Available auxiliary contacts	Side-mounted accessories		
			Auxiliary contact blocks		
			CAL18-11	CAL18-11B (3)	Mechanical interlock units (between two contactors)

Contactors + auxiliary contact blocks

AF400 ... AF2650	3	0	1	1	1 x CAL18-11	+	2 x CAL18-11B	-
------------------	---	---	---	---	--------------	---	---------------	---

Contactors with mechanical interlocking + auxiliary contact blocks

AF400 ... AF2650	3	0	1	1	2 x CAL18-11 (1)	+	4 x CAL18-11B (1)	+	VM...H (2)
------------------	---	---	---	---	------------------	---	-------------------	---	------------

(1) Total number of auxiliary contact blocks for the two contactors. (2) Interlock type, according to the contactor ratings (see "Accessories").
(3) The CEL18-... auxiliary contact blocks can replace the CAL18-11 and CAL18-11B. Though, no auxiliary contact block can be mounted outside the CEL18-...

Overload relays fitting details

Contactor types	Thermal overload relays	Electronic overload relays
AF400, AF460	-	E500DU (150...500 A) (4)
AF580, AF750	-	E800DU (250...800 A) (4)
AF1350, AF1650	-	E1250DU (375...1250 A) (4)

The addition of a thermal or electronic overload relay on the contactor does not prevent fitting of many other accessories as shown in "Main accessory fitting details" table.
(4) Mounting kit required (see overload relay page).

AF09 ... AF38 4-pole contactors

Accessory fitting details

Contactor and main accessories (other accessories available)

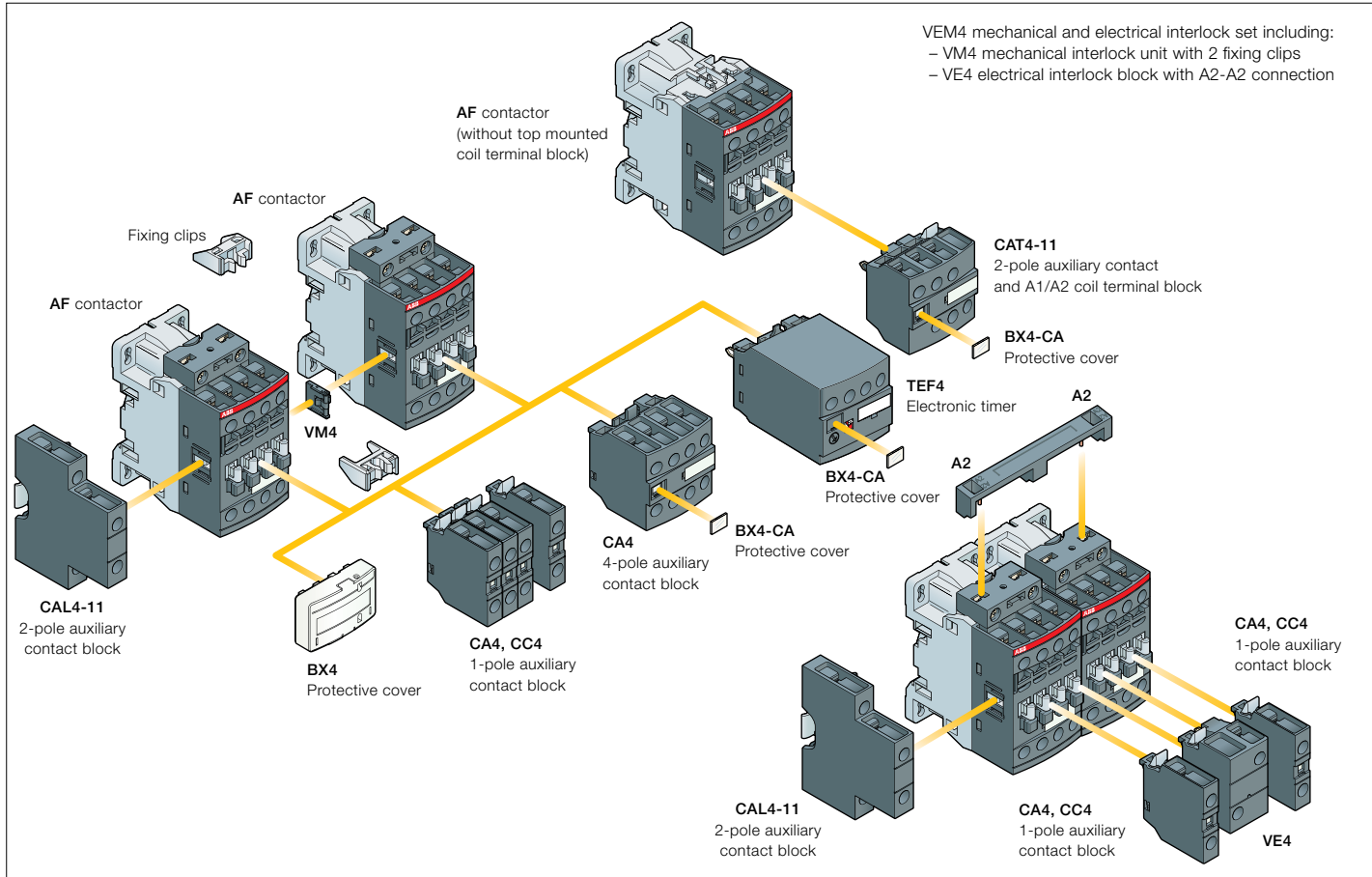

Main accessory fitting details

Many configurations of accessories are possible depending on whether these are front-mounted or side-mounted.

Contactor types	Main poles	Built-in auxiliary contacts	Front-mounted accessories				Side-mounted accessories			
			Auxiliary contact blocks			Electronic timer	Electrical and mechanical interlock set (between 2 contactors)	Auxiliary contact blocks		
			1-pole CA4	2-pole CAT4-11	4-pole CA4	TEF4	VEM4	Left side	Right side	
			1-pole CC4					2-pole CAL4-11		
Max. add-on N.C. auxiliary contacts: 4 N.C. max. on positions 1, 2, 3, 4 and 3 N.C. max. on positions 1 ±30°, 5										
AF09 ... AF16	4	0	0	0	4 max. or 1	or 1	or 1	+	1	-
					2 max. or 1	-	or 1	+	1	+ 1
					3 max. -	-	-	+	1	or 1
Max. add-on N.C. auxiliary contacts: 3 N.C. max. on positions 1, 2, 3, 4 and 2 N.C. max. on positions 1 ±30°, 5										
AF26 ... AF38	4	0	0	0	4 max. or 1	or 1	or 1	+	1	-
					2 max. or 1	-	or 1	+	1	+ 1
					3 max. -	-	-	+	1	or 1
AF09 ... AF16	2	2	0	0	4 max. or 1	or 1	or 1	+	1	-
AF26 ... AF38	2	2	0	0	2 max. or 1	-	or 1	+	1	+ 1

NF 4-pole control relays

Accessory fitting details

Control relays and main accessories (other accessories available)

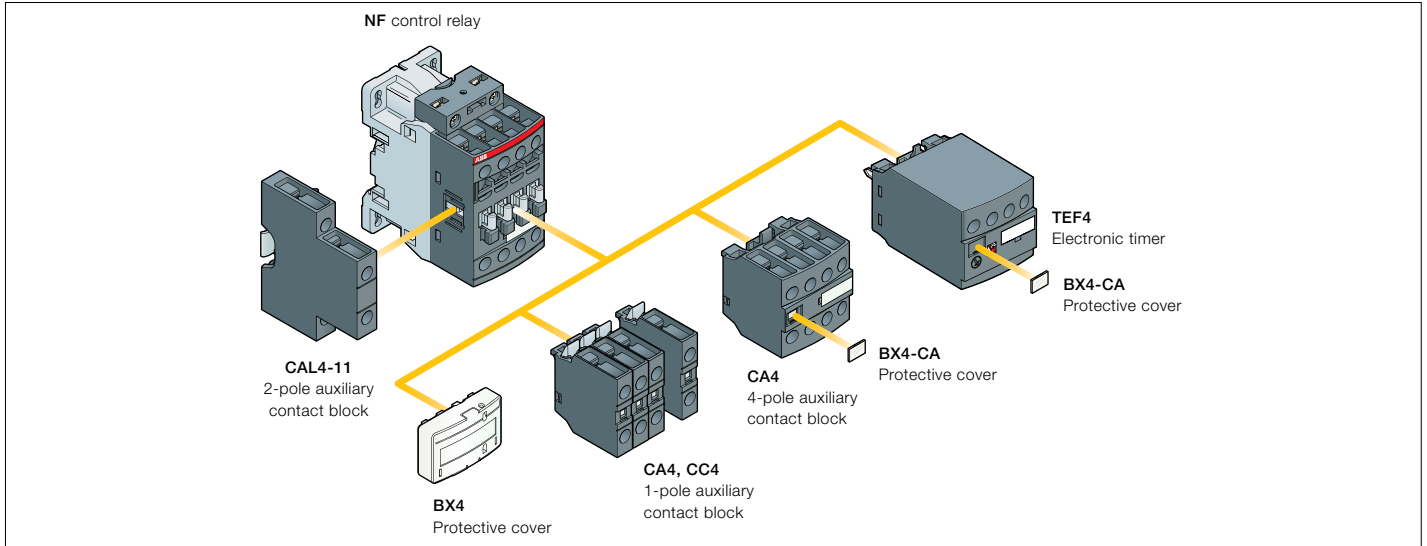

Main accessory fitting details

Many configurations of accessories are possible depending on whether these are front-mounted or side-mounted.

Control relay types	Main poles	Front-mounted accessories			Electronic timer		Side-mounted accessories	
		Auxiliary contact blocks			TEF4		Left side	Right side
		1-pole CA4	1-pole CC4	4-pole CA4			2-pole CAL4-11	
Max. add-on N.C. auxiliary contacts: 3 N.C. max. on positions 1, 2, 3, 4 and 2 N.C. max. on positions 1 ±30°, 5								
NF	2 2 3 1	E	4 max.	or 1	or 1	+	1	-
		E	2 max.	-	or 1	+	1	+ 1
Max. add-on N.C. auxiliary contacts: 4 N.C. max. on positions 1, 2, 3, 4 and 3 N.C. max. on positions 1 ±30°, 5								
NF	4 0	E	4 max.	or 1	or 1	+	1	-
		E	2 max.	-	or 1	+	1	+ 1

For NF control relays + CE5 auxiliary contacts for severe industrial environments

Main accessory fitting details

Many configurations of accessories are possible depending on whether these are front-mounted or side-mounted.

Control relay types	Main poles	Front-mounted accessories			Side-mounted accessories	
		Auxiliary contact blocks			Left side	Right side
		1-pole CE5	1-pole CA4	1-pole CC4	2-pole CAL4-11	
Max. add-on N.C. auxiliary contacts (CA4, CC4, CAL4): 1 max. with 1 CE5 on positions 1, 2, 3, 4						
NF	2 2 3 1	E	1	+ 3 max.	+	1
		E				
Max. add-on N.C. auxiliary contacts (CA4, CC4, CAL4): 2 max. with 1 CE5, none with 2 CE5 on positions 1, 2, 3, 4						
NF	4 0	E	2	+ 2 max.	-	-
		E	1	+ 3 max.	-	-
		E	1	+ 1 max.	+	1
Max. add-on N.C. auxiliary contacts (CA4, CC4): none with 1 CE5 on positions 1 ±30°, 5						
NF	2 2 3 1	E	1	+ 3 max.	-	-
		E				
Max. add-on N.C. auxiliary contacts (CA4, CC4, CAL4): 1 max. with 1 CE5 on positions 1 ±30°, 5						
NF	4 0	E	1	+ 3 max.	-	+
		E				1

NF 8-pole control relays

Accessory fitting details

Control relays and main accessories (other accessories available)

2

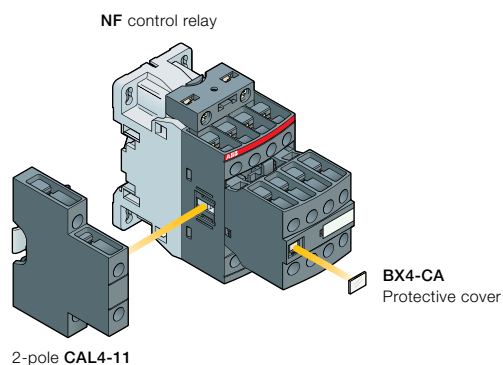

Main accessory fitting details

Many configurations of accessories are possible depending on whether these are front-mounted or side-mounted.

Control relay types	Main poles	Front-mounted accessories				Side-mounted accessories																
		Auxiliary contact blocks				Auxiliary contact blocks																
		1-pole CA4	1-pole CC4	4-pole CA4	Left side	Right side																
					2-pole CAL4-11																	
NF	<table border="0"> <tr> <td>4</td> <td>4</td> <td>E</td> </tr> <tr> <td>5</td> <td>3</td> <td>E</td> </tr> <tr> <td>6</td> <td>2</td> <td>E</td> </tr> <tr> <td>7</td> <td>1</td> <td>E</td> </tr> <tr> <td>8</td> <td>0</td> <td>E</td> </tr> </table>	4	4	E	5	3	E	6	2	E	7	1	E	8	0	E	-	-	-	+	1	-
4	4	E																				
5	3	E																				
6	2	E																				
7	1	E																				
8	0	E																				

Auxiliary contact blocks for AF09 ... AF96 contactors and NF control relays



CA4-10



CAL4-11



CA4-22E



CAT4-11E

Description

The auxiliary contact blocks are used for the operation of auxiliary circuits and control circuits for standard industrial environments.

Types of auxiliary contact blocks for front mounting:

- CA4 1 or 4-pole block, with instantaneous N.O., N.C. contacts
- CC4 1-pole block, with N.O. leading contact or N.C. lagging contact
- CAT4 2-pole block, with instantaneous N.O. + N.C. contacts and A1 / A2 coil terminal connection on front face.

Select the 4-pole auxiliary contact blocks CA4-..E, CA4-..M, CA4-..U or CA4-..N type, according to the contactor or contactor relay type for compliance with the standard requirements (see "Terminal marking and positioning").





Types of auxiliary contact blocks for side mounting:

- CAL4 2-pole block, with instantaneous N.O. + N.C. contacts.

For clipping onto the right- and/or left-hand side of the contactors.

The auxiliary contact blocks are equipped with screw type connecting terminals delivered open, protected against accidental direct contact and bear the corresponding function marking.

Ordering details (1)

For contactors	Auxiliary contacts	Catalog number	Global reference code	Pkg qty	Weight (1 pce)
	   				kg

Front-mounted instantaneous auxiliary contact blocks

AF09 ... AF96 4-pole NF	1 0 - -	CA4-10	1SBN010110R1010	1	0.014
	1 0 - -	CA4-10-T	1SBN010110T1010	10	0.014
	0 1 - -	CA4-01	1SBN010110R1001	1	0.014
	0 1 - -	CA4-01-T	1SBN010110T1001	10	0.014
AF09 ... AF16..-30-10	2 2 - -	CA4-22M	1SBN010140R1122	1	0.055
	3 1 - -	CA4-31M	1SBN010140R1131	1	0.055
	1 3 - -	CA4-13M	1SBN010140R1113	1	0.055
	0 4 - -	CA4-04M	1SBN010140R1104	1	0.055
AF26 ... AF96..-30-00 AF09 ... AF38..-40-00 AF09 ... AF38..-22-00	2 2 - -	CA4-22E	1SBN010140R1022	1	0.055
	3 1 - -	CA4-31E	1SBN010140R1031	1	0.055
	4 0 - -	CA4-40E	1SBN010140R1040	1	0.055
	0 4 - -	CA4-04E	1SBN010140R1004	1	0.055
AF09 ... AF16..-30-01	2 2 - -	CA4-22U	1SBN010140R1322	1	0.055
	3 1 - -	CA4-31U	1SBN010140R1331	1	0.055
	4 0 - -	CA4-40U	1SBN010140R1340	1	0.055
	2 2 - -	CA4-22N	1SBN010140R1222	1	0.055
4-pole NF	3 1 - -	CA4-31N	1SBN010140R1231	1	0.055
	4 0 - -	CA4-40N	1SBN010140R1240	1	0.055
	1 3 - -	CA4-13N	1SBN010140R1213	1	0.055
	0 4 - -	CA4-04N	1SBN010140R1204	1	0.055
NF..40E					

Front-mounted auxiliary contact blocks with N.O. leading contact and N.C. lagging contact

AF09 ... AF96 4-pole NF	- - 1 0	CC4-10	1SBN010111R1010	1	0.014
	- - 0 1	CC4-01	1SBN010111R1001	1	0.014

Side-mounted instantaneous auxiliary contact blocks

AF09 ... AF96 NF	1 1 - -	CAL4-11	1SBN010120R1011	1	0.040
	1 1 - -	CAL4-11-T	1SBN010120T1011	10	0.040

Front-mounted instantaneous auxiliary contact and A1/A2 coil terminal blocks

AF09 ... AF16..-30-10	1 1 - -	CAT4-11M	1SBN010151R1111	1	0.040
AF26 ... AF65..-30-00 AF09 ... AF38..-40-00 AF09 ... AF38..-22-00	1 1 - -	CAT4-11E	1SBN010151R1011	1	0.040
AF09 ... AF16..-30-01	1 1 - -	CAT4-11U	1SBN010151R1311	1	0.040

(1) For each contactor or contactor relay type, refer to "Accessory fitting details" table.

Note: CAT4 not suitable for AF.Z contactors with DC control voltage 12...20 V DC.

Auxiliary contact blocks for AF116 ... AF2650 contactors

2



CAL19-11

Description

The auxiliary contact blocks are used for the operation of auxiliary circuits and control circuits for standard industrial environments.

Types of auxiliary contact blocks for side mounting:



- CAL 2-pole block, with instantaneous N.O. + N.C. contacts.

For clipping onto the right- and/or left-hand side of the contactors.

The CAL ...-11B is a second block for mounting in addition to a first CAL ...-11 block, right- and/or left-hand of the AF116 ... AF2650 contactors.

The auxiliary contact blocks are equipped with screw type connecting terminals delivered open, protected against accidental direct contact and bear the corresponding function marking.

Ordering details

For contactors	Auxiliary contacts	Catalog number	Global reference code	Pkg qty	Weight (1 pce)
	 				kg

Side-mounted instantaneous auxiliary contact blocks

AF116 ... AF370	1	1	CAL19-11	1SFN010820R1011	2	0.040
	1	1	CAL19-11B	1SFN010820R3311	2	0.040
AF400 ... AF2650	1	1	CAL18-11	1SFN010720R1011	2	0.050
	1	1	CAL18-11B	1SFN010720R3311	2	0.050

(1) For each contactor type, refer to "Accessory fitting details" table.



CAL18-11

Auxiliary contact blocks for AF09 ... AF38 contactors and NF control relays for severe industrial environments



CE5-10W

Description





The auxiliary contact blocks are used for the operation of auxiliary circuits and control circuits for severe industrial environments.

Types of auxiliary contact blocks for front mounting:

- CE5 1-pole block, instantaneous with N.O. contact or N.C. contact, available in 2 IP degrees
- CE5 D with built-in microswitch IP40, degree of protection (IP20 on terminals)
- CE5 W with built-in microswitch IP67, degree of protection (IP20 on terminals).

The auxiliary contact blocks are equipped with screw type connecting terminals delivered open, protected against accidental direct contact and bear the corresponding function marking.

Ordering details (1)

For contactors	Auxiliary contacts	Catalog number	Global reference code	Pkg qty	Weight (1 pce)
	   				kg
AF09 ... AF38	1 - - -	CE5-10D0.1	1SBN010015R1010	1	0.020
NF	- 1 - -	CE5-01D0.1	1SBN010015R1001	1	0.020
	1 - - -	CE5-10D2	1SBN010017R1010	1	0.020
	- 1 - -	CE5-01D2	1SBN010017R1001	1	0.020
	1 - - -	CE5-10W0.1	1SBN010016R1010	1	0.020
	- 1 - -	CE5-01W0.1	1SBN010016R1001	1	0.020
	1 - - -	CE5-10W2	1SBN010018R1010	1	0.020
	- 1 - -	CE5-01W2	1SBN010018R1001	1	0.020

(1) For each contactor type, refer to "Accessory fitting details" table.

Auxiliary contact blocks for AF400 ... AF2650 contactors for severe industrial environments

2



CEL18

Description

The auxiliary contact blocks are used for the operation of auxiliary and control circuits for severe industrial environments.



Types of auxiliary contact blocks for side mounting:

- CEL18 1-pole block, with built-in microswitch IP67 degree of protection (IP20 on terminals). Instantaneous N.O. or N.C. contact.

For clipping onto the right- and/or left-hand side of the contactors.

The auxiliary contact blocks are equipped with screw type connecting terminals delivered open, protected against accidental direct contact and bear the corresponding function marking.

Ordering details (1)

For contactors	Auxiliary contacts	Catalog number	Global reference code	Pkg qty	Weight (1 pce)
	 				kg
Side-mounting instantaneous auxiliary contact blocks					
AF400 ... AF2650	1 0	CEL18-10	1SFN010716R1010	1	0.050
	0 1	CEL18-01	1SFN010716R1001	1	0.050

(1) For each contactor type, refer to "Accessory fitting details" table.

Impulse contact blocks

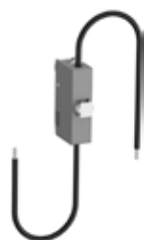

CB5

Description

Impulse contact blocks are designed for use in enclosures, in association with an adjustable mechanical pushbutton. Two types are available:

CB5-10: N.O. contact with a black actuator ("ON" function)

CB5-01: N.C. contact with a light grey actuator ("OFF" function).

These blocks are equipped with 2 connecting leads 0.5 mm² with end, approximately 18 cm long.

Mounting: Clipped onto the front face of the contactors.

Ordering details

For contactors	Contacts	Catalog number	Global reference code	Pkg qty	Weight (1 pce) kg
AF09 ... AF38	1 -	CB5-10	1SBN010013R1010	1	0.012
	- 1	CB5-01	1SBN010013R1001	1	0.012

Note: For AF40 ... AF96 mounting: please consult us.

Main dimensions mm, inches

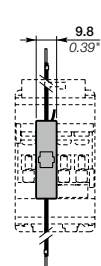

CB5-10

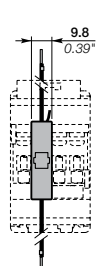
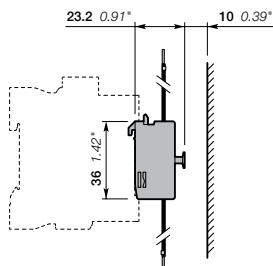

CB5-01

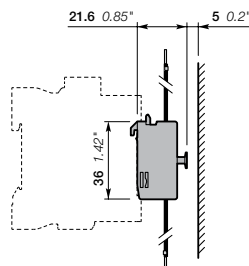

Electronic timers

2



TEF4-ON

Description

TEF4 front-mount electronic timers are used for timing function and are available in ON-delay and OFF-delay versions.

Compact solution in cabinet compared to separate timers

TEF4 electronic timers are front-mounted and clip on AF contactors or NF control relays. A mechanical indicator shows the state of the contactor.

Safe and cost-reduced wiring

TEF4 electronic timers are supplied by a direct plug-in parallel connection to the coil terminals A1 - A2 of the contactor or contactor relay. A varistor is integrated on the timer to offer a built-in protection against surges in the contactor coil.

Available for a wide control voltage range 24...240 V AC/DC

TEF4-ON or TEF4-OFF allow time-delayed functions up to 100 s in 3 distinct time ranges, independently of the control system. The time delay ranges are selected by a switch and the time delay can be adjusted by means of a rotary switch. The timing function is activated by closing or opening the device on which the timer is mounted. The OFF-delay version operates without additional control supply.



TEF4-OFF

Ordering details

For contactors, control relays	Time delay range selected by switch	Delay type	Rated control circuit voltage U_c	Auxiliary contacts	Catalog number	Global reference code	Weight Pkg (1 pce) kg
AF09 ... AF96 NF	0.1...1 s	ON-delay	24...240	1 1	TEF4-ON	1SBN020112R1000	0.065
	1...10 s 10...100 s	OFF-delay	24...240	1 1	TEF4-OFF	1SBN020114R1000	0.065



VM4



VM19

Mechanical interlock units

Description

The VM mechanical interlock units are designed for the interlocking of two AF contactors. When mounted between two contactors, the VM mechanical interlock unit prevents one of the contactors from closing as long as the other contactor is closed.

The mechanical interlock units VM4 and VM96-4 include 2 fixing clips.

Ordering details

For contactors	Mounting	Catalog number	Global reference code	Pkg qty	Weight (1 pce) kg
Mechanical interlock units for two contactors mounted side by side					
AF09 ... AF38...-30-... AF09 ... AF38...-40-00	Fixed between two contactors, mounted flush side by side	VM4	1SBN030105T1000	10	0.005
AF40 ... AF96 For same size contactors: AF116 ... AF146 AF190, AF205 AF265 ... AF370		VM96-4	1SBN033405T1000	10	0.006
AF116 ... AF146 and AF190, AF205		VM19	1SFN030300R1000	1	0.054
AF116 ... AF146 and AF190, AF205		VM140/190	1SFN034403R1000	1	0.088
AF190, AF205 and AF265 ... AF370		VM205/265	1SFN035203R1000	1	0.090
AF400 ... AF1250	PN.. mounting plate to be ordered separately	VM750H	1SFN035700R1000	1	0.200
AF1350 ... AF2650	Plate included	VM1650H	1SFN036503R1000	1	6.000
Mechanical interlock units for two contactors mounted one above the other					
AF400 ... AF1250	Additional plate (not supplied)	VM750V	1SFN035701R1000	1	0.200

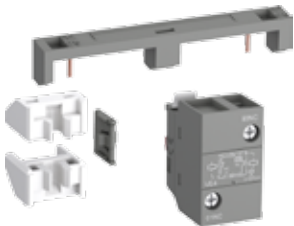

VEM4

Mechanical and electrical interlock sets

Description

VEM4 mechanical and electrical interlock set for the interlocking of two AF contactors. VEM4 set includes a mechanical interlock unit VM4 with 2 fixing clips (BB4) and a VE4 electrical interlock block with A2-A2 connection.

Fixing the electrical interlock block to the contactor front face connects the 2 built-in N.C. interlocking contacts with the two coils. VE4 block must be used with A2-A2 connection to respect the electrical connection diagram.

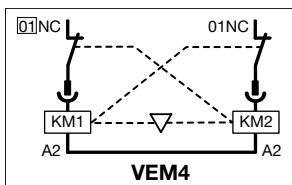

Ordering details

For contactors	Auxiliary contacts	Catalog number	Global reference code	Pkg qty	Weight (1 pce) kg
Mechanical and electrical interlock set					
For same size contactors: AF09 ... AF16...-30-... AF26 ... AF38...-30-00 AF09, AF16...-40-00 AF26, AF38...-40-00	0 2	VEM4	1SBN030111R1000	1	0.035
Fixing clips					
AF09 ... AF38		BB4	1SBN110120W1000	50	0.002



BB4

Note: VEM4 not suitable for AF..Z contactors with DC control voltage 12...20 V DC.

Mechanical latching units

2



WB75-A

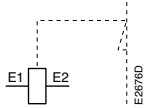

Terminal marking

Description

For converting standard contactors into latched contactors.

The WB75-A block contains a mechanical latching device with electromagnetic impulse unlatching (AC or DC) or manual unlatching.

Captive screw type connecting terminals, built-in cable clamps, M3.5 (+, -) pozidriv 2 screw with screwdriver guidance; delivered untightened and protected against accidental direct contact.

Operation

After closing, the contactor continues to be held in the closed position by the latching mechanism should the supply voltage fail at the contactor coil terminals.

Contactor opening can be controlled:

- electrically by an impulse (AC or DC) on the WB75-A block coil.
(the coil is not designed to be permanently energized)
- manually by pressing the pushbutton on the front face of the WB75-A block.

Mounting

The WB75-A block is clipped onto the front face of the 1-stack contactor where it takes up two slots. The two other slots do not accept CA4 single pole auxiliary contacts. Up to 2 CAL4-11 auxiliary contact blocks can be side-mounted on contactors (except NF22E and AF..-22-00, refer to main accessory fitting details table in main accessories section).

Ordering details

For contactors	Rated control circuit voltage Uc		Catalog number	Global reference code	Pkg qty	Weight (1 pce) kg
	V 50 Hz or DC	V 60 Hz				
AF09 ... AF38 NF	24	24...28	WB75A-01	FPTN372726R1001	1	0.120
	42	42...48	WB75A-02	FPTN372726R1002	1	0.120
	48	48...55	WB75A-03	FPTN372726R1003	1	0.120
	110	110...127	WB75A-04	FPTN372726R1004	1	0.120
	220...230	220...255	WB75A-06	FPTN372726R1006	1	0.120
	230...240	230...277	WB75A-05	FPTN372726R1005	1	0.120
	380...415	380...440	WB75A-07	FPTN372726R1007	1	0.120
	415...440	440...480	WB75A-08	FPTN372726R1008	1	0.120

Note: For WB75-A produced since week 06-2012.

Other accessories



LDC4

Ordering details

For contactors	Catalog number	Global reference code	Pkg qty	Weight (1 pce)
				kg



BX4

Additional coil terminal blocks

Additional coil terminal blocks for contactors or control relays.

AF09 ... AF96, NF	LDC4	1SBN070156T1000	10	0.010
-------------------	------	-----------------	----	-------

Protective covers

Sealable and transparent protective covers BX4 and non-removable BX4-CA to protect the devices against accidental contact.

AF09 ... AF96 1-stack contactors and NF contactor relays	BX4	1SBN110108T1000	10	0.006
4-pole CA4, 2-pole CAT4 auxiliary contact blocks and TEF4 electronic timer	BX4-CA	1SBN110109W1000	50	0.001

Note: BX4 produced since 13045 (day 045 - year 2013) are suitable for AF40 ... AF96.



BX4-CA



BA4

Function markers AF09 ... AF370

Box of 16 blank cards (16 markers by card) printable on HTP500 thermal transfer printer and AMS 500 marking table to identify your contactors, overload relays or manual motor starters.
Marker dimensions: 7 x 20 mm (.276" x .787").

AF09 ... AF370 contactors, TF thermal overload relays, EF electronic overload relays and MS116, MS132 manual motor starters	BA4	1SNA235156R2700	16	0.011
AMS 500 support plate for 8 BA4	XUSP02633	1SNA360010R1500	1	0.220
HTP500 support plate	HTP500-BA4	1SNA235712R2400	1	0.290



BA5-50

Function markers AF400 ... AF2650

Set of 50 function markers designed to be clipped onto the front face of devices. Details can be added to these markers using a ball point pen, indelible felt-tip pen or pentel white.
Self-adhesive labels (not supplied) can also be added to them.
Marker dimensions: 7 x 19 mm (.276" x .748").

AF400 ... AF2650 and accessories	BA5-50	1SBN110000R1000	50	0.017
----------------------------------	--------	-----------------	----	-------

Main dimensions mm, inches

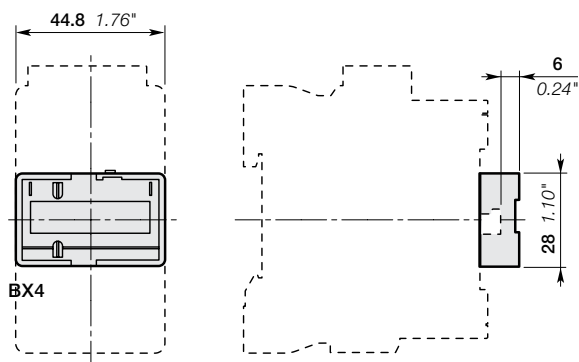

Other accessories



2

BP38-4



BDT4
For AF09 ... AF65, NF



BDT4
For AF80 ... AF96

Ordering details

For contactors	Catalog number	Global reference code	Pkg qty	Weight (1 pce)
				kg

Mounting pieces

Mounting piece for replacing A Line contactors mounted by screws with AF Range contactors.

From contactor	To contactor				
A26 ... A40, AL26 ... AL40	AF09 ... AF38	BP38-4	1SBN112303T1000	10	0.003
A40 ... A75, AE50 ... AE75, AF50 ... AF75	AF40 ... AF65	BP65-4	1SBN113403T1000	10	0.004
A95, A110, AE95, AE110, AF95, AF110	AF80 ... AF96	BP96-4	1SBN113903T1000	10	0.005

Test block

BDT4 test block is suitable for switching on contactor off-load.

Marking on the block indicates the contactor type to fit with.

AF09 ... AF96, NF	BDT4	1SBN110122T1000	10	0.007
-------------------	------	-----------------	----	-------

Main dimensions mm, inches

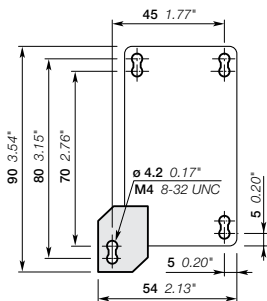

BP38-4

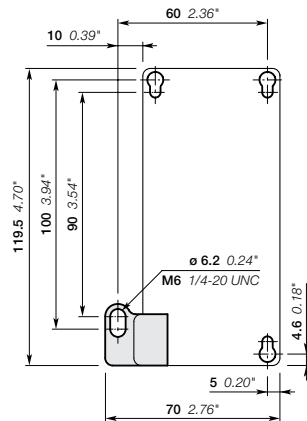

BP65-4

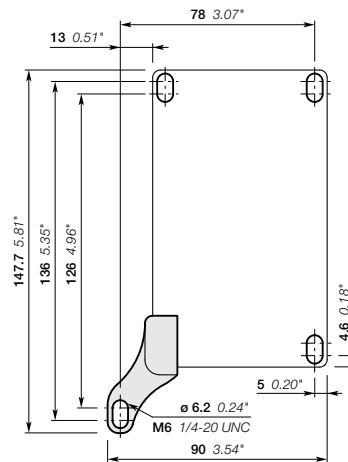

BP96-4

Terminal shrouds and mechanical lugs



LT140-30L



LT370-30C



LT460-AC



ATK185

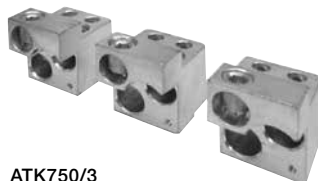

ATK750/3

Description

Main terminal protection for AF116 ... AF1250 contactors.

The auxiliary contact blocks and coils are designed to provide an IP 20 degree of protection.

The main terminals, equipped with compression lugs or cable clamps, can be protected against accidental direct contact after wiring (EN 50274) by the addition of terminal shrouds (see table below).

Ordering details

For contactors	Catalog number	Global reference code	Pkg qty	Weight (1 pce) kg
AF116 ... AF146, with compression lugs	LT140-30L	1SFN124203R1000	2	0.070
AF190, AF205, with cable clamps	LT205-30C	1SFN124801R1000	2	0.050
AF190, AF205, with compression lugs	LT205-30L	1SFN124803R1000	2	0.220
AF190, AF205, with shorting bar or between contactor and TOL/EOL in DOL starters	LT205-30Y	1SFN124804R1000	1	0.050
AF265 ... AF370, with cable clamps	LT370-30C	1SFN125401R1000	2	0.035
AF265 ... AF370, with compression lugs	LT370-30L	1SFN125403R1000	2	0.280
AF265 ... AF370, with shorting bar or between contactor and TOL/EOL in DOL starters	LT370-30Y	1SFN125404R1000	1	0.075
AF265 ... AF370, for use with extending cable clamps, ATK300/2 and OZXB4	LT370-30D	1SFN125406R1000	1	0.15
AF400, AF460 with cable clamps	LT460-AC	1SFN125701R1000	2	0.100
AF400, AF460 with compression lugs	LT460-AL	1SFN125703R1000	2	0.800
AF580, AF750 with cable clamps	LT750-AC	1SFN126101R1000	2	0.120
AF580, AF1250 with compression lugs	LT750-AL	1SFN126103R1000	2	0.825

Description

Large contactors (AF190 and above) include bar terminals as standard to easily facilitate the use of busbar as a means of internal wiring. Mechanical lugs are a common solution for allowing the use of stranded or solid wire, and are widely utilized for field wiring termination.

Ordering details

For contactors (1)	Description	Catalog number	Global reference code	Pkg qty	Weight (1 pce) kg
AF190, AF205	Lug kit, 1-wire, 4 AWG ... 300 MCM	ATK185	(2)	3	0.164
AF265 ... AF370	Lug kit, 1-wire, 4 AWG ... 400 MCM	ATK300	(2)	3	0.166
AF265 ... AF370	Lug kit, 2-wire, 4 AWG ... 500 MCM	ATK300/2	(2)	3	0.445
AF400 ... AF580	Lug kit, 2-wire, 2/0 AWG ... 500 MCM	ATK580/2	(2)	3	0.345
AF580, AF750	Lug kit, 3-wire, 2/0 AWG ... 500 MCM	ATK750/3	(2)	3	1.071
AF1350	Lug kit, 4-wire, 4/0 AWG ... 500 MCM (3)	ATK1350/4	(2)	3	1.883
AF1350, AF1650	Lug kit, 4-wire, 1/0 AWG ... 750 MCM (3)	ATK1650/4	(2)	3	3.353
AF1350, AF1650	Lug kit, 6-wire, 1/0 AWG ... 750 MCM (3)	ATK1650/6	(2)	3	4.378
AF190, AF205	Spare terminal hardware	LE185	1SFN074716R1000	1 set	0.200
AF265 ... AF370	Spare terminal hardware	LE300	1SFN075116R1000	1 set	0.300
AF400 ... AF580	Spare terminal hardware	LE460	1SFN075716R1000	1 set	0.600
AF580, AF750	Spare terminal hardware	LE750	1SFN076116R1000	1 set	0.750

(1) Note: AF1250, AF2050 & AF2650 intended for busbar connection only and terminal hardware is intended to be sourced separately.

(2) North American applications only.

(3) Note: Use of lug kits for AF1350 & AF1650 in general use applications reduces the ratings to 1050A and 1350A respectively. Recommend busbar connection for full ratings.

Terminal enlargements and extensions

2



LW140

Terminal enlargements

Description

Enlargement pieces designed to increase the width of the contactor terminal pads in order to allow larger connections to be mounted.

Ordering details

For contactors	Dimensions		Catalog number	Global reference code	Pkg qty	Weight (1 pce)
	hole Ø mm	bar mm				
AF116 ... AF146	6.5	13 x 3	LW140	1SFN074207R1000	1	0.115
AF190, AF205	10.5	17.5 x 5	LW205	1SFN074807R1000	1	0.260
AF265 ... AF370	10.5	20 x 5	LW370	1SFN075407R1000	1	0.340
AF400, AF460	10.5	25 x 5	LW460	1SFN075707R1000	1	0.730
AF580, AF750	13	40 x 6	LW750	1SFN076107R1000	1	1.230
AF1250	13	50 x 10	LW1250	1SFN076407R1000	1	2.000



LX140

Terminal extension

Description

Extension pieces designed to extend the main terminals of contactors for combined mounting of contactors and connection sets.

Ordering details

For contactors	Dimensions		Catalog number	Global reference code	Pkg qty	Weight (1 pce)
	hole Ø mm	bar mm				
AF116 ... AF146	6.5	13 x 3	LX140	1SFN074210R1000	1	0.072
AF190, AF205	8.5	17.5 x 5	LX205	1SFN074810R1000	1	0.180
AF265 ... AF370	10.5	20 x 5	LX370	1SFN075410R1000	1	0.234
AF400, AF460	10.5	25 x 5	LX460	1SFN075710R1000	1	0.500
AF580, AF750	13	40 x 6	LX750	1SFN076110R1000	1	0.850

Connection module

Description

Connection module can be fixed on AF116 ... AF146 delivered with bar terminals.



LD146-30

Ordering details

For contactor	Catalog number	Global reference code	Pkg qty	Weight (1 pce)
AF116 ... AF146	LD146-30	1SFN074208R1000	2	0.165

Terminal connecting strips and shorting bars



LY16-4



LY185



LH38-4



LF16-4



LG16-4

Description

Parallel and series connection of 3-pole contactors:

To obtain a star point (3 parallel-connected poles)

To connect poles in parallel and thus increase the AC load passing through the flow path made up of the parallel-connected poles: LP, LY, LH, LF, LG.

The relevant cable cross-sectional area may limit the maximum permissible current. Consult information in table below

To connect poles in series and thus increase the DC load controlled by the poles: LP, LY (only LY16-4 and LY38-4 selectable strips).

Types	for connection of "n" poles	with terminal	insulated
LP	n = 2	no	no (1)
LY	n = 2 (selectable LY16-4, LY38-4 connecting strips)	no	yes
	n = 3	no	yes (1)
LH	n = 2	yes	no
LF	n = 3	yes	yes
LG	n = 4	yes	yes

(1) LP460 ... LP750, LY185 ... LY750 not insulated. Use terminal shrouds.

Ordering details

For contactors	max. nominal continuous current with "n" poles				Cable cross-sectional area mm ²	Catalog number	Global reference code	Pkg qty	Weight (1 pce) kg
	in parallel		in series						
	2 poles	3 poles	4 poles	2 poles					
	A								
AF09	30	33	-	25	6	LY16-4	1SBN071303T1000	10	0.006
AF12	32	36	-	27					
AF16	34	40	-	30					
AF26	50	60	-	45	10	LY38-4	1SBN072303T1000	10	0.012
AF116 ... AF146	-	240	-	-	-	LY140	1SFN074203R1000	1	0.055
AF190, AF205	-	400	-	-	-	LY185	1SFN074703R1000	1	0.200
AF265 ... AF370	-	670	-	-	-	LY300	1SFN075103R1000	1	0.300
AF400, AF460	-	1000	-	-	-	LY460	1SFN075703R1000	1	0.450
AF580, AF750	-	1650	-	-	-	LY750	1SFN076103R1000	1	0.800
AF190, AF205	300	-	-	-	-	LP185	1SFN074712R1000	2	0.300
AF265 ... AF370	475	-	-	-	-	LP300	1SFN075112R1000	2	0.400
AF400, AF460	725	-	-	-	-	LP460	1SFN075712R1000	2	0.550
AF580, AF750	1200	-	-	-	-	LP750	1SFN076112R1000	2	0.950
AF09	45	-	-	-	10	LH38-4	1SBN072304R1000	2	0.012
AF12	50	-	-	-	10				
AF16	54	-	-	-	16				
AF26	81	-	-	-	25				
AF30, AF38	90	-	-	-	25				
AF09	-	62	-	-	16	LF16-4	1SBN071305R1000	2	0.020
AF12	-	70	-	-	25				
AF16	-	75	-	-	25				
AF26	-	112	-	-	35	LF38-4	1SBN072305R1000	2	0.040
AF30, AF38	-	125	-	-	50				
AF09	-	-	70	-	25	LG16-4	1SBN071306R1000	2	0.025
AF12	-	-	78	-	25				
AF16	-	-	84	-	25				

Main dimensions

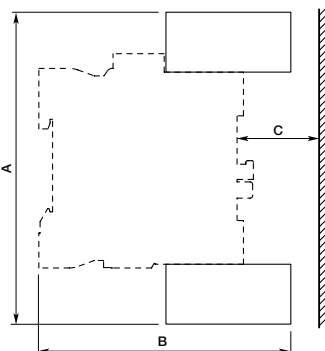

Type	For contactors	Dimensions					
		A		B		C	
		mm	inch	mm	inch	mm	inch
LH38-4	AF09 ... AF16	111.20	4.38"	83	3.27"	22	0.87"
	AF26 ... AF38	114	4.49"	86	3.39"	16	0.63"
LF16-4	AF09 ... AF16	121	4.76"	87	3.43"	23	0.91"
LF38-4	AF26 ... AF38	135.20	5.32"	103	4.06"	31	1.22"
LG16-4	AF09 ... AF16	124.20	4.89"	87	3.43"	23	0.91"

Reversing and phase-to-phase bus kits

2

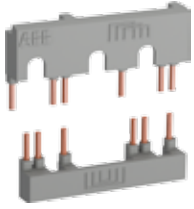

BER16-4

Connection sets for reversing contactors

Description

The BER and BEM connection sets are used to connect the main poles of two 3-pole contactors mounted side by side.

The BER connection sets are made up of 1 upstream and 1 downstream connections.

The BEM connection sets are made up of 3 upstream and 3 downstream connections.

BER and BEM connection sets are insulated and made of solid copper bars.

Ordering details

For 3-pole contactors	Catalog number	Global reference code	Pkg qty	Weight (1 pce) kg
AF09 ... AF16	BER16-4	1SBN081311R1000	1	0.045
AF26 ... AF38	BER38-4	1SBN082311R1000	1	0.100
AF40 ... AF65	BER65-4	1SBN083411R1000	1	0.175
AF80, AF96	BER96-4	1SBN083911R1000	1	0.250
AF116 ... AF146	BER140-4	1SFN084211R1000	1	0.615
AF190, AF205	BER205-4	1SFN084811R1000	1	1.237
AF265 ... AF370	BER370-4	1SFN085411R1000	1	2.140
AF400, AF460	BEM460-30	1SFN085701R1000	1	4.400
AF580, AF750	BEM750-30	1SFN086101R1000	1	7.300

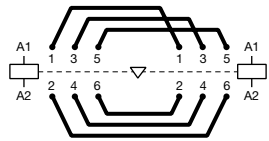

BER, BEM
Reversing connections

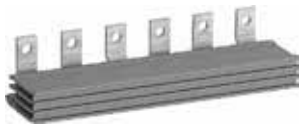

BEP140-30

3-pole phase to phase connections

Description

The BEP and BES connection sets are used to connect phase to phase the main poles of two 3-pole contactors mounted side by side.

The BEP connection sets are made up of 1 upstream or downstream connections.

The BES connection sets are made up of 3 upstream or downstream connections.

BEP and BES connection sets are insulated and made of solid copper bars.

Ordering details

For 3-pole contactors	Catalog number	Global reference code	Pkg qty	Weight (1 pce) kg
AF116 ... AF146	BEP140-30	1SFN084214R1000	1	0.320
AF190, AF205	BEP205-30	1SFN084814R1000	1	0.534
AF265 ... AF370	BEP370-30	1SFN085414R1000	1	0.926
AF400, AF460	BES460	1SFN085704R1000	1	2.200
AF580, AF750	BES750	1SFN086104R1000	1	3.700

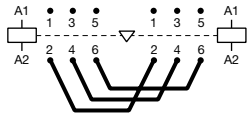

BEP, BES
Phase to phase connections

Wye-delta bus kits

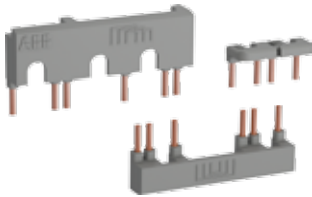

BEY16-4

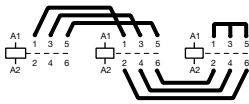

AF09 ... AF750
1M - 2M -1S

Description

The BEY and BED connection sets are used to connect the main poles of the Line, Delta and Wye contactors of a wye-delta starter.

The connection sets are made up of:

- Line contactor / delta contactor:
 - BEY: upstream phase-to-phase connection
 - BED: upstream connection in parallel
- Delta contactor / Wye contactor: downstream connection in parallel
- Wye contactor: Wye point upstream
- Insulated, solid copper bar.

Ordering details

For 3-pole line, delta & wye contactors	Interlock unit between delta & wye contactors	Catalog number	Global reference code	Pkg qty	Weight (1 pce) kg
AF09 ... AF16	With or without VM4 or VEM4	BEY16-4	1SBN081313R2000	1	0.050
AF26 ... AF38	With or without VM4 or VEM4	BEY38-4	1SBN082713R2000	1	0.110
AF40 ... AF65	With or without VM96-4	BEY65-4	1SBN083413R2000	1	0.200
AF80, AF96	With or without VM96-4	BEY96-4	1SBN083913R2000	1	0.250
AF116 ... AF146	With or without VM19	BEY140-4	1SFN084413R1000	1	1.040
AF190 ... AF205 (line and delta) AF140 ... AF146 (wye)	With or without VM140/190	BEY190-4	1SFN084813R1000	1	1.154
AF190, AF205	With or without VM19	BEY205-4	1SFN085213R1000	1	1.205
AF265 ... AF370 (line and delta) AF190 ... AF205 (wye)	With or without VM205/265	BEY265-4	1SFN085413R1000	1	2.020
AF265 ... AF370	With or without VM19	BEY370-4	1SFN085813R1000	1	2.110
AF400 ... AF460	With or without VM750H	BED460U	-	1	4.700
AF580 ... AF750 (line and delta) AF400 ... AF460 (wye)	With or without VM750H	BED580U	-	1	6.300
AF580 ... AF750	With or without VM750H	BED750U	-	1	7.700

Coupling units

2

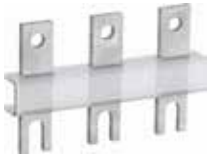

BEA140/XT2



BEA205/T4



BEA370/T5

Connection bars between contactors and MCCB

Description

Connection between contactors/starters and moulded case circuit breakers.
These connection sets are solid copper bars.

Ordering details

For contactors	MCCB	Catalog number	Global reference code	Pkg qty	Weight (1 pce) kg
Vertical assembly					
AF116 ... AF146	XT2	BEA140/XT2	1SFN084206R1000	1	0.058
AF116 ... AF146	XT4	BEA140/XT4	1SFN084206R1001	1	0.068
AF190, AF205	XT4	BEA205/XT4	1SFN084806R1000	1	0.200
AF190, AF205	T4	BEA205/T4	1SFN084806R1001	1	0.190
AF265 ... AF370	T5	BEA370/T5	1SFN085406R1000	1	0.350
AF400 ... AF750	T6	BEA750/T6	1SFN086106R1000	1	0.410
AF400 ... AF750	T5	BEA750/T5	1SFN086106R1001	1	0.410
Vertical assembly with control wire terminals (also suitable when using busbar kits for starter combinations)					
AF400 ... AF750	T5	BEA750D/T5	1SFN086106R1003	1	0.720
AF400 ... AF750	T6	BEA750D/T6	1SFN086106R1002	1	0.720
Horizontal assembly (also suitable when using busbar kits for starter combinations)					
AF400, AF460	T4	BEA460H/T4	1SFN085907R1000	1	2.450

Connection bars between contactors and fusible disconnects

Description

Connection between contactors/starters and fusible disconnect switches.
These connection sets are solid copper bars.

Ordering details

For contactors	Switch fuse	Catalog number	Global reference code	Pkg qty	Weight (1 pce) kg
Vertical assembly					
AF400, AF460	OESA400	BEF460/OESA400	1SFN085708R1000	1	0.340
AF460 ... AF750	OESA630 to OESA800	BEF750/OESA800	1SFN086108R1000	1	0.740
Horizontal assembly					
AF400, AF460	OESA400...LR	OESA460H/OESA400	1SFN085709R1000	1	1.250

Note: The BEF connection bars provided for the A145 ... A300 contactors can be used for the AF145 ... AF300 contactors.

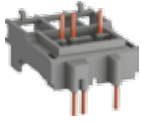

BEA16-4

Connecting links with manual motor starters

Description

The BEA insulated 3-pole connecting links are used to connect AF09 ... AF38 contactors with the MS116 or MS132 manual motor starters. The BEA insulated 3-pole connecting links ensure the electrical and mechanical connection between the contactor and the associated manual motor starter.

2

Ordering details

For 3-pole contactors	Manual motor starter	Catalog number	Global reference code	Pkg qty	Weight (1 pce) kg
AF09 ... AF16	MS116-0.16 ... MS116-25, MS132-0.16... MS132-25	BEA16-4	1SBN081306T1000	10	0.025
AF26 ... AF38	MS116-0.16 ... MS116-16, MS132-0.16 ... MS132-10	BEA26-4	1SBN082306T1000	10	0.025
	MS116-20 ... MS116-32, MS132-12 ... MS132-32	BEA38-4	1SBN082306T2000	10	0.030

Mounting plates

2



PN460

Description

Mounting plates with fixing holes for the specified contactors and overload relays.

Ordering details

For contactors	For overload relays	Catalog number	Global reference code	Pkg qty	Weight (1 pce)
					kg

Mounting plates for Direct on line starters

AF400, AF460	E500DU	PN460-11	1SFN095705R1000	1	2.120
AF580, AF750	E800DU	PN750-11	1SFN096105R1000	1	2.500

For two contactors side by side with space for mechanical interlock	For one or two overload relays	Catalog number	Global reference code	Pkg qty	Weight (1 pce)
					kg

Mounting plates for mechanical interlocked contactors, reversing starters and two speed starters for double windings

AF400, AF460	E500DU	PN460-21	1SFN095701R1000	1	3.490
AF580, AF750	E800DU	PN750-21	1SFN096101R1000	1	4.230

For main and delta contactors	For wye contactor (1)	For overload relays	Catalog number	Global reference code	Pkg qty	Weight (1 pce)
						kg

Mounting plates for wye-delta starters and two speed starters for single windings

AF400, AF460	A300, AF400	E500DU	PN460-41	1SFN095703R1000	1	5.310
AF580, AF750	AF400 ... AF580	E800DU	PN750-41	1SFN096103R1000	1	6.320

(1) Space for mechanical interlock included.

Adapter plates

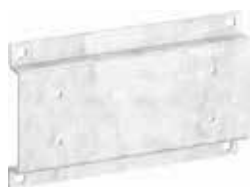

PR146-1

Description

Adapter plates with fixing holes for replacing installed contactors.

Ordering details

From contactors	To contactor	Catalog number	Global reference code	Pkg qty	Weight (1 pce)
A95, AF95, A110, AF110	AF116, AF140, AF146	PR146-1	1SFN094200R1000	1	0.300
EH150, EH160, EH175, EH210, EG160	AF190, AF205	PR210-1	1SFN094900R1000	1	0.440
EH250, EH260, EH300	AF265, AF305, AF370	PR300-1	1SFN095300R1000	1	0.560
EH370, EH550, EG315	AF400, AF460, AF580	PR460-1	1SFN095700R1000	1	0.900
EH700, EH800	AF750	PR750-1	1SFN096100R1000	1	0.500
OKYM150, OKYM175	AF190	PR185-2	1SFN095100R1001	1	0.500
OKYM200, OKYM250	AF265, AF305, AF370	PR300-2	1SFN095300R1001	1	0.500
OKYM315	AF400, AF460	PR400-2	1SFN095700R1002	1	0.820
OKYM400	AF400, AF460	PR460-2	1SFN095700R1001	1	0.800
OKYM500	AF580	PR580-2	1SFN096100R1002	1	0.700
EH550, EG630, OKYM630	AF580, AF750	PR750-2	1SFN096100R1001	1	1.100

Note: for smaller devices, see mounting pieces on the other accessories page.

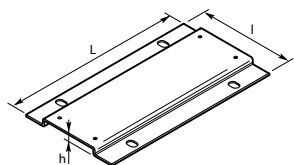

Dimensions (mm)

Type of the plate	Dimensions			Fixing holes
	L	l	h	mm
PR146-1	150	90	15	4 x \varnothing 6.5
PR210-1	200	132	11.5	4 x \varnothing 7
PR300-1	200	172	11.5	4 x \varnothing 7
PR460-1	278	198	11.5	4 x \varnothing 7
PR750-1	283	244	11.5	4 x \varnothing 7
PR185-2	202	152	11.2	4 x \varnothing 11
PR300-2	202	152	11.2	4 x \varnothing 11
PR400-2	278	151	11.5	4 x \varnothing 11
PR460-2	278	176	11.5	4 x \varnothing 11
PR580-2	283	176	11.5	4 x \varnothing 11
PR750-2	283	255	11.5	4 x \varnothing 14

Fixing holes according to the plate types

Service parts

Contactors coils, main contact sets and arc chutes

2



ZAF1650

Contactors coils

Ordering details

For contactors	Rated control circuit voltage Uc min. ... Uc max.		Catalog number	Global reference code	Pkg qty	Weight (1 pce) kg
	V 50/60 Hz	V DC				
AF400, AF460	-	24...60	ZAF460-68	1SFN155770R6806	1	0.525
	48...130	48...130	ZAF460-69	1SFN155770R6906	1	0.525
	100...250	100...250	ZAF460-70	1SFN155770R7006	1	0.525
	250...500	250...500	ZAF460-71	1SFN155770R7106	1	0.525
AF580 ... AF1250	-	24...60	ZAF750-68	1SFN156170R6806	1	1.335
	48...130	48...130	ZAF750-69	1SFN156170R6906	1	1.335
	100...250	100...250	ZAF750-70	1SFN156170R7006	1	1.335
	250...500	250...500	ZAF750-71	1SFN156170R7106	1	1.335
AF1350 ... AF2050	100...250	100...250	ZAF1650-70 (1)	1SFN156570R7026	1 set	0.900
			ZP1650 (2)	1SFN166521R1070	1	0.300
AF2650	100...250	100...250	ZAF2650-70 (1)	1SFN156670R7026	1 set	0.900
			ZP2650 (2)	1SFN166621R1070	1	0.300

(1) One set of two coil.
(2) Printed circuit board.

Main contact sets

Description

The contact sets for 3-pole contactors consists of six fixed contacts, three moving contacts, springs and the required screws.

Ordering details

For contactors	Catalog number	Global reference code	Pkg qty	Weight (1 pce) kg
AF400	ZL400	1SFN165703R1000	1 set	1.320
AF460	ZL460	1SFN165903R1000	1 set	1.320
AF580	ZL580	1SFN166103R1000	1 set	1.840
AF750	ZL750	1SFN166303R1000	1 set	1.840
AF1250	ZL1250	1SFN166403R1000	1 set	1.840
AF1350 (1)	ZL1350	1SFN166503R1000	1 set	2.500
AF1650 (1)	ZL1650	1SFN166703R1000	1 set	3.500
AF2050 (1)	ZL2050	1SFN167003R1000	1 set	3.500
AF2650 (2)	ZL2650	1SFN166603R1000	1 set	1.200

(1) Six fixed, three moving contacts per each power pole.
(2) Moving contacts only.

Arc chutes

Description

The arc chute sets for 3-pole contactors include six arc chutes, two for each power pole.

Ordering details

For contactors	Catalog number	Global reference code	Pkg qty	Weight (1 pce) kg
AF400, AF460	ZW460	1SFN165710R1000	1 set	1.380
AF580, AF750, AF1250	ZW750	1SFN166110R1000	1 set	1.500
AF1350, AF1650, AF2050	ZW1650	1SFN166510R1000	1 set	4.000
AF2650	ZW2650	1SFN166610R1000	1 set	4.000

AF09 ... AF38 3-pole contactors

Technical data

Main pole - Utilization characteristics according to IEC

Contactors types	AC / DC operated	AF09	AF12	AF16	AF26	AF30	AF38
Standards		IEC 60947-1 / 60947-4-1 and EN 60947-1 / 60947-4-1					
Rated operational voltage U _e max.		690 V					
Rated frequency (without derating)		50 / 60 Hz					
Conventional free-air thermal current I _{th}							
acc. to IEC 60947-4-1, open contactors, $\theta \leq 40\text{ }^\circ\text{C}$		35 A	35 A	35 A	50 A	50 A	50 A
With conductor cross-sectional area		6 mm ²	6 mm ²	6 mm ²	10 mm ²	10 mm ²	10 mm ²
AC-1 Utilization category							
For air temperature close to contactor							
I_e / Rated operational current AC-1	$\theta \leq 40\text{ }^\circ\text{C}$	25 A	28 A	30 A	45 A	50 A	50 A
U _e max. $\leq 690\text{ V}$, 50/60 Hz	$\theta \leq 60\text{ }^\circ\text{C}$	25 A	28 A	30 A	40 A	42 A	42 A
	$\theta \leq 70\text{ }^\circ\text{C}$	22 A	24 A	26 A	32 A	37 A	37 A
With conductor cross-sectional area		4 mm ²	6 mm ²	6 mm ²	10 mm ²	10 mm ²	10 mm ²
AC-3 Utilization category							
For air temperature close to contactor $\theta \leq 60\text{ }^\circ\text{C}$							
I_e / Max. rated operational current AC-3 (1)							
	220-230-240 V	9 A	12 A	18 A	26 A	33 A	40 A
	380-400 V	9 A	12 A	18 A	26 A	32 A	38 A
	415 V	9 A	12 A	18 A	26 A	32 A	38 A
	440 V	9 A	12 A	18 A	26 A	32 A	38 A
	500 V	9,5 A	12,5 A	15 A	23 A	28 A	33 A
	690 V	7 A	9 A	10,5 A	17 A	21 A	24 A
Rated operational power AC-3 (1)							
	220-230-240 V	2,2 kW	3 kW	4 kW	6,5 kW	9 kW	11 kW
	380-400 V	4 kW	5,5 kW	7,5 kW	11 kW	15 kW	18,5 kW
	415 V	4 kW	5,5 kW	9 kW	11 kW	15 kW	18,5 kW
	440 V	4 kW	5,5 kW	9 kW	15 kW	18,5 kW	22 kW
	500 V	5,5 kW	7,5 kW	9 kW	15 kW	18,5 kW	22 kW
	690 V	5,5 kW	7,5 kW	9 kW	15 kW	18,5 kW	22 kW
Rated making capacity AC-3		10 x I _e AC-3 acc. to IEC 60947-4-1					
Rated breaking capacity AC-3		8 x I _e AC-3 acc. to IEC 60947-4-1					
AC-8a Utilization category							
(without thermal overload relay - U _e 400 V 50/60 Hz - $\theta \leq 40\text{ }^\circ\text{C}$)							
I_e / Rated operational current AC-8a		12 A	16 A	22 A	30 A	40 A	50 A
Rated operational power AC-8a		5,5 kW	7,5 kW	11 kW	15 kW	20 kW	25 kW
Short-circuit protection device for contactors							
without thermal overload relay - Motor protection excluded (2)							
U _e $\leq 500\text{ V AC}$ - gG type fuse		25 A	32 A	32 A	50 A	63 A	63 A
Rated short-time withstand current I_{cw}							
at 40 °C ambient temperature,	1 s	300 A	300 A	300 A	700 A	700 A	700 A
in free air from a cold state	10 s	150 A	150 A	150 A	350 A	350 A	350 A
	30 s	80 A	80 A	80 A	225 A	225 A	225 A
	1 min	60 A	60 A	60 A	150 A	150 A	150 A
	15 min	35 A	35 A	35 A	50 A	50 A	50 A
Maximum breaking capacity							
cos $\phi = 0,45$	at 440 V	250 A	250 A	250 A	500 A	500 A	500 A
	at 690 V	106 A	106 A	106 A	200 A	200 A	200 A
Power dissipation per pole							
	I _e / AC-1	0,8 W	1 W	1,2 W	1,8 W	2,4 W	2,4 W
	I _e / AC-3	0,1 W	0,2 W	0,35 W	0,6 W	0,9 W	1,3 W
Max. electrical switching frequency							
	AC-1	600 cycles/h					
	AC-3	1200 cycles/h					
	AC-2, AC-4	300 cycles/h				150 cycles/h	

(1) For the corresponding kW/A or hp/A values of 1500 r.p.m, 50 Hz or 1800 r.p.m, 60 Hz, 3-phase motors, see "Motor rated operational powers and currents".

(2) For the protection of motor starters against short circuits, see "Coordination with short-circuit protection devices".

AF40 ... AF96 3-pole contactors

Technical data

Main pole - Utilization characteristics according to IEC

Contactor types	AC / DC operated	AF40	AF52	AF65	AF80	AF96	
Standards		IEC 60947-1 / 60947-4-1 and EN 60947-1 / 60947-4-1					
Rated operational voltage U_e max.		690 V					
Rated frequency (without derating)		50 / 60 Hz					
Conventional free-air thermal current I_{th} acc. to IEC 60947-4-1, open contactors, $\theta \leq 40^\circ\text{C}$ With conductor cross-sectional area		105 A	105 A	105 A	130 A	130 A	
		35 mm ²	35 mm ²	35 mm ²	50 mm ²	50 mm ²	
AC-1 Utilization category							
For air temperature close to contactor							
I_e / Rated operational current AC-1 U_e max. ≤ 690 V, 50/60 Hz	$\theta \leq 40^\circ\text{C}$	70 A	100 A	105 A	125 A	130 A	
	$\theta \leq 60^\circ\text{C}$	60 A	80 A	90 A	100 A	105 A	
	$\theta \leq 70^\circ\text{C}$	50 A	70 A	80 A	85 A	90 A	
With conductor cross-sectional area		25 mm ²	35 mm ²	35 mm ²	50 mm ²	50 mm ²	
AC-3 Utilization category							
For air temperature close to contactor $\theta \leq 60^\circ\text{C}$							
I_e / Max. rated operational current AC-3 (1)	220-230-240 V	40 A	53 A	65 A	80 A	96 A	
	380-400 V	40 A	53 A	65 A	80 A	96 A	
	415 V	40 A	53 A	65 A	80 A	96 A	
	440 V	40 A	53 A	65 A	80 A	96 A	
	500 V	35 A	45 A	55 A	65 A	80 A	
	690 V	25 A	35 A	39 A	49 A	57 A	
	Rated operational power AC-3 (1)						
	220-230-240 V	11 kW	15 kW	18.5 kW	22 kW	25 kW	
	380-400 V	18.5 kW	22 kW	30 kW	37 kW	45 kW	
	415 V	22 kW	30 kW	37 kW	45 kW	55 kW	
	440 V	22 kW	30 kW	37 kW	45 kW	55 kW	
	500 V	22 kW	30 kW	37 kW	45 kW	55 kW	
690 V	22 kW	30 kW	37 kW	45 kW	55 kW		
Rated making capacity AC-3							
10 x I_e AC-3 acc. to IEC 60947-4-1							
Rated breaking capacity AC-3							
8 x I_e AC-3 acc. to IEC 60947-4-1							
AC-8a Utilization category							
(without thermal overload relay - U_e 400 V 50/60 Hz - $\theta \leq 40^\circ\text{C}$)							
I_e / Rated operational current AC-8a		53 A	70 A	85 A	105 A	120 A	
	Rated operational power AC-8a	25 kW	37 kW	45 kW	55 kW	65 kW	
Short-circuit protection device for contactors							
without thermal overload relay - Motor protection excluded (2)							
$U_e \leq 500$ V AC - gG type fuse							
Rated short-time withstand current I_{cw} at 40 °C ambient temperature, in free air from a cold state	1 s	1000 A	1000 A	1000 A	1200 A	1200 A	
	10 s	600 A	600 A	600 A	780 A	780 A	
	30 s	350 A	350 A	350 A	450 A	450 A	
	1 min	250 A	250 A	250 A	300 A	300 A	
	15 min	110 A	110 A	110 A	140 A	140 A	
Maximum breaking capacity							
cos $\varphi = 0.45$							
	at 440 V	(3)					
	at 690 V	(3)					
Power dissipation per pole	I_e / AC-1	3 W	6.3 W	7 W	7.6 W	8.2 W	
	I_e / AC-3	1 W	1.7 W	2.7 W	3 W	4.5 W	
Max. electrical switching frequency	AC-1	600 cycles/h					
	AC-3	1200 cycles/h					
	AC-2, AC-4	150 cycles/h					

(1) For the corresponding kW/A or hp/A values of 1500 r.p.m, 50 Hz or 1800 r.p.m, 60 Hz, 3-phase motors, see "Motor rated operational powers and currents".

(2) For the protection of motor starters against short circuits, see "Coordination with short-circuit protection devices".

(3) On request.

AF116 ... AF370 3-pole contactors

Technical data

Main pole - Utilization characteristics according to IEC

Contactor types	AC / DC operated	AF116	AF140	AF146	AF190	AF205	AF265	AF305	AF370
Standards		IEC 60947-1 / 60947-4-1 and EN 60947-1 / 60947-4-1							
Rated operational voltage Ue max.		690 V	690 V	1000 V	1000 V	1000 V	1000 V	1000 V	1000 V
Rated frequency (without derating)		50 / 60 Hz							
Conventional free-air thermal current Ith		160 A	200 A	225 A	275 A	350 A	400 A	500 A	600 A
acc. to IEC 60947-4-1, open contactors, $\theta \leq 40^\circ\text{C}$ With conductor cross-sectional area		70 mm ²	95 mm ²	95 mm ²	150 mm ²	240 mm ²	240 mm ² (3)	300 mm ²	2 x 185 mm ² (4)
AC-1 Utilization category									
For air temperature close to contactor									
Ie / Rated operational current AC-1	$\theta \leq 40^\circ\text{C}$	160 A	200 A	225 A	275 A	350 A	400 A	500 A	600 A
Ue max. $\leq 690\text{ V}$, 50/60 Hz	$\theta \leq 60^\circ\text{C}$	145 A	175 A	200 A	250 A	300 A	350 A	400 A	500 A
	$\theta \leq 70^\circ\text{C}$	130 A	160 A	175 A	200 A	240 A	290 A	325 A	400 A
Ie / Rated operational current AC-1	$\theta \leq 40^\circ\text{C}$	—	—	225 A	250 A	275 A	350 A	375 A	400 A
Ue max. $\leq 1000\text{ V}$, 50/60 Hz	$\theta \leq 60^\circ\text{C}$	—	—	200 A	225 A	250 A	300 A	325 A	350 A
	$\theta \leq 70^\circ\text{C}$	—	—	175 A	185 A	200 A	240 A	260 A	290 A
With conductor cross-sectional area		70 mm ²	95 mm ²	95 mm ²	150 mm ²	240 mm ²	240 mm ² (3)	300 mm ²	2 x 185 mm ² (4)
AC-3 Utilization category									
For air temperature close to contactor $\theta \leq 60^\circ\text{C}$									
Ie / Max. rated operational current AC-3 (1)									
	220-230-240 V	116 A	140 A	146 A	190 A	205 A	265 A	305 A	370 A
	380-400 V	116 A	140 A	146 A	190 A	205 A	265 A	305 A	370 A
	415 V	116 A	140 A	146 A	190 A	205 A	265 A	305 A	370 A
	440 V	116 A	140 A	146 A	190 A	205 A	265 A	305 A	370 A
	500 V	110 A	130 A	130 A	160 A	185 A	260 A	290 A	350 A
	690 V	65 A	80 A	93 A	135 A	165 A	250 A	290 A	315 A
	1000 V	—	—	60 A	85 A	100 A	100 A	100 A	100 A
Rated operational power AC-3 (1)									
	220-230-240 V	30 kW	37 kW	45 kW	55 kW	55 kW	75 kW	90 kW	110 kW
	380-400 V	55 kW	75 kW	75 kW	90 kW	110 kW	132 kW	160 kW	200 kW
	415 V	55 kW	75 kW	75 kW	90 kW	110 kW	132 kW	160 kW	200 kW
	440 V	75 kW	90 kW	90 kW	110 kW	132 kW	160 kW	160 kW	200 kW
	500 V	75 kW	90 kW	90 kW	110 kW	132 kW	160 kW	200 kW	250 kW
	690 V	55 kW	75 kW	90 kW	132 kW	160 kW	200 kW	250 kW	315 kW
	1000 V	—	—	75 kW	110 kW	132 kW	132 kW	132 kW	132 kW
Rated making capacity AC-3		10 x Ie AC-3 acc. to IEC 60947-4-1							
Rated breaking capacity AC-3		8 x Ie AC-3 acc. to IEC 60947-4-1							
Short-circuit protection device for contactors									
without thermal overload relay - Motor protection excluded (2)									
Ue $\leq 500\text{ V}$ AC - gG type fuse		250 A	315 A	315 A	355 A	400 A	500 A	500 A	630 A
Rated short-time withstand current Icw	1 s	1300 A	1460 A	1460 A	1900 A	2050 A	2650 A	3050 A	3700 A
at 40 °C ambient temperature,	10 s	928 A	1168 A	1168 A	1520 A	1640 A	2120 A	2440 A	2960 A
in free air from a cold state	30 s	536 A	674 A	674 A	878 A	947 A	1224 A	1409 A	1709 A
	1 min	379 A	477 A	477 A	621 A	670 A	865 A	996 A	1208 A
	15 min	160 A	200 A	225 A	275 A	350 A	400 A	500 A	600 A
Maximum breaking capacity									
cos $\varphi = 0.45$	at 440 V	2000 A	3000 A	3000 A	3300 A	3500 A	3800 A	4600 A	5000 A
(cos $\varphi = 0.35$ for Ie > 100 A)	at 690 V	1000 A	1500 A	1500 A	2200 A	2500 A	3300 A	3800 A	4000 A
Power dissipation per pole									
	Ie / AC-1	12 W	18 W	23 W	15 W	25 W	32 W	50 W	72 W
	Ie / AC-3	6 W	9 W	10 W	7 W	8 W	14 W	19 W	27 W
Maximum electrical switching frequency									
	AC-1	300 cycles/h							
	AC-3	300 cycles/h							
	AC-2, AC-4	150 cycles/h							

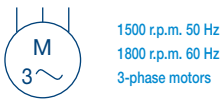

(1) For the corresponding kW/A or hp/A values of 1500 r.p.m, 50 Hz or 1800 r.p.m, 60 Hz, 3-phase motors, see "Motor rated operational powers and currents".
 (2) For the protection of motor starters against short circuits, see "Coordination with short-circuit protection devices".
 (3) For currents above 275A use terminal enlargements or terminal extensions.
 (4) For currents above 450A use terminal enlargements or terminal extensions.

AF400 ... AF2650 3-pole contactors

Technical data

Main pole - Utilization characteristics according to IEC

Contactor types	AC / DC operated	AF400	AF460	AF580	AF750	AF1250	AF1350	AF1650	AF2050	AF2650	
Standards		IEC 60947-1 / 60947-4-1 and EN 60947-1 / 60947-4-1									
Rated operational voltage Ue max.		1000 V									
Rated frequency (without derating)		50/60 Hz									
Conventional free-air thermal current Ith		acc. to IEC 60947-4-1, open contactors, $\theta \leq 40^\circ\text{C}$									
	With conductor cross-sectional area (3)	600 A	700 A	800 A	1050 A	1260 A	1350 A	1650 A	2050 A	2650 A	
		2x185 mm ²	2x240 mm ²	2x240 mm ²	800 mm ² (4)	1000 mm ² (4)	1000 mm ² (5)	1500 mm ² (5)	2000 mm ² (5)	3000 mm ² (5)	
AC-1 Utilization category		For air temperature close to contactor									
	Ie / Rated operational current AC-1	$\theta \leq 40^\circ\text{C}$									
	Ue max. $\leq 690\text{ V}$, 50/60 Hz	600 A	700 A	800 A	1050 A	1260 A	1350 A	1650 A	2050 A	2650 A	
		$\theta \leq 55^\circ\text{C}$									
		500 A	600 A	700 A	875 A	1040 A	1150 A	1450 A	1750 A	2350 A	
		$\theta \leq 70^\circ\text{C}$									
		400 A	480 A	580 A	720 A	875 A	1000 A	1270 A	1500 A	2120 A	
	Ie / Rated operational current AC-1	$\theta \leq 40^\circ\text{C}$									
	Ue max. $\leq 1000\text{ V}$, 50/60 Hz	600 A	700 A	800 A	1000 A	1260 A	1350 A	1650 A	2050 A	2650 A	
		$\theta \leq 55^\circ\text{C}$									
		500 A	600 A	700 A	875 A	1040 A	1150 A	1450 A	1750 A	2350 A	
		$\theta \leq 70^\circ\text{C}$									
		400 A	480 A	580 A	720 A	875 A	1000 A	1270 A	1500 A	2120 A	
	With conductor cross-sectional area	2x185 mm ²	2x240 mm ²	2x240 mm ²	800 mm ² (4)	1000 mm ² (4)	1000 mm ² (5)	1500 mm ² (5)	2000 mm ² (5)	3000 mm ² (5)	
AC-3 Utilization category		For air temperature close to contactor $\theta \leq 55^\circ\text{C}$									
	Ie / Max. rated operational current AC-3 (1)										
	220-230-240 V	400 A	460 A	580 A	750 A	-	860 A	1050 A	-	-	
	380-400 V	400 A	460 A	580 A	750 A	-	860 A	1050 A	-	-	
	415 V	400 A	460 A	580 A	750 A	-	860 A	1050 A	-	-	
	440 V	400 A	460 A	580 A	750 A	-	860 A	1050 A	-	-	
	500 V	400 A	460 A	580 A	750 A	-	800 A	950 A	-	-	
	690 V	350 A	400 A	500 A	650 A	-	800 A	950 A	-	-	
	1000 V	155 A	200 A	250 A	300 A	-	-	-	-	-	
	Rated operational power AC-3 (1)										
	220-230-240 V	110 kW	132 kW	160 kW	220 kW	-	257 kW	315 kW	-	-	
	380-400 V	200 kW	250 kW	315 kW	400 kW	-	475 kW	560 kW	-	-	
	415 V	220 kW	250 kW	355 kW	425 kW	-	500 kW	600 kW	-	-	
	440 V	220 kW	250 kW	355 kW	450 kW	-	560 kW	670 kW	-	-	
	500 V	250 kW	315 kW	400 kW	520 kW	-	560 kW	700 kW	-	-	
	690 V	315 kW	355 kW	500 kW	600 kW	-	750 kW	900 kW	-	-	
	1000 V	220 kW	280 kW	355 kW	400 kW	-	-	-	-	-	
	Rated making capacity AC-3	10 x Ie AC-3 acc. to IEC 60947-4-1									
	Rated breaking capacity AC-3	8 x Ie AC-3 acc. to IEC 60947-4-1									
Short-circuit protection device for contactors		without thermal overload relay									
	Motor protection excluded (2)										
	Ue $\leq 500\text{ V AC}$ - gG type fuse	630 A	800 A	1000 A	1000 A	Please consult us for coordination with circuit-breaker					
Rated short-time withstand current Icw		at 40 °C ambient temperature, in free air from a cold state									
	1 s	4600 A	4600 A	7000 A	7000 A	8000 A	10000 A	12000 A	12000 A	12000 A	
	10 s	4400 A	4400 A	6400 A	6400 A	7200 A	8000 A	10000 A	10000 A	10000 A	
	30 s	3100 A	3100 A	4500 A	4500 A	5200 A	6000 A	7500 A	7500 A	7500 A	
	1 min	2500 A	2500 A	3500 A	3500 A	4000 A	4500 A	5500 A	5500 A	5500 A	
	15 min	840 A	840 A	1300 A	1300 A	1500 A	1600 A	2200 A	2200 A	2800 A	
Maximum breaking capacity		cos $\varphi = 0.45$									
	at 440 V	4000 A	5000 A	6000 A	7500 A	10000 A					
	at 690 V	3500 A	4500 A	5000 A	7000 A	-					
	(cos $\varphi = 0.35$ for Ie > 100 A)										
Power dissipation per pole		Ie / AC-1									
		30 W	42 W	32 W	50 W	80 W	80 W	80 W	125 W	200 W	
	Ie / AC-3	16 W	21 W	17 W	28 W	-	50 W	50 W	-	-	
Max. electrical switching frequency		AC-1									
		300 cycles/h			300 cycles/h			300 cycles/h		60 cycles/h	
	AC-3	300 cycles/h			300 cycles/h			-		60 cycles/h	
	AC-2, AC-4	60 cycles/h			60 cycles/h			-		-	

(1) For the corresponding kW/A or hp/A values of 1500 r.p.m, 50 Hz or 1800 r.p.m, 60 Hz, 3-phase motors, see "Motor rated operational powers and currents".

(2) For the protection of motor starters against short circuits, see "Coordination with short-circuit protection devices".

(3) Conductors with preparation.

(4) Max. connection bar width 50 mm.

(5) Max. connection bar width 100 mm.

AF09 ... AF38 3-pole contactors

Technical data

Main pole - Utilization characteristics according to UL / NEMA / CSA

Contactor types	AC / DC operated	AF09	AF12	AF16	AF26	AF30	AF38	
Standards		UL 60947-1 / 60947-4-1A and CSA 60947-1 / 60947-4-1A						
Max. operational voltage		600 V						
NEMA size		00	0	-	1	-	-	
NEMA continuous amp rating	Thermal current	9 A	18 A		27 A			
NEMA maximum horse power ratings 1-phase, 60 Hz	115 V AC	1/3 hp	1 hp		2 hp			
	230 V AC	1 hp	2 hp		3 hp			
NEMA maximum horse power ratings 3-phase, 60 Hz	200 V AC	1-1/2 hp	3 hp		7-1/2 hp			
	230 V AC	1-1/2 hp	3 hp		7-1/2 hp			
	460 V AC	2 hp	5 hp		10 hp			
	575 V AC	2 hp	5 hp		10 hp			
UL / CSA general use rating	600 V AC	25 A	28 A	30 A	45 A	50 A	50 A	
	With conductor cross-sectional area	AWG 10	AWG 10	AWG 10	AWG 8	AWG 8	AWG 8	
UL / CSA maximum 1-phase motor rating	Full load current	120 V AC	13.8 A	16 A	20 A	24 A	24 A	
		240 V AC	10 A	12 A	17 A	17 A	28 A	
	Horse power rating	120 V AC	3/4 hp	1 hp	1-1/2 hp	2 hp	2 hp	
		240 V AC	1-1/2 hp	2 hp	3 hp	3 hp	5 hp	
UL / CSA maximum 3-phase motor rating	Full load current (1)	200-208 V AC	7.8 A	11 A	17.5 A	25.3 A	32.2 A	32.2 A
		220-240 V AC	6.8 A	9.6 A	15.2 A	22 A	28 A	28 A
		440-480 V AC	7.6 A	11 A	14 A	21 A	27 A	27 A
		550-600 V AC	9 A	11 A	17 A	22 A	27 A (2)	27 A (2)
	Horse power rating (1)	200-208 V AC	2 hp	3 hp	5 hp	7-1/2 hp	10 hp	10 hp
		220-240 V AC	2 hp	3 hp	5 hp	7-1/2 hp	10 hp	10 hp
		440-480 V AC	5 hp	7-1/2 hp	10 hp	15 hp	20 hp	20 hp
		550-600 V AC	7-1/2 hp	10 hp	15 hp	20 hp	25 hp (2)	25 hp (2)
Short-circuit protection device for contactors								
without thermal overload relay - Motor protection excluded								
High fault current		100 kA						
Fuse rating		30 A	30 A	60 A	60 A	100 A	200 A	
Fuse type, 600 V		J						
Max. electrical switching frequency								
For general use		600 cycles/h						
For motor use		1200 cycles/h						

(1) For the corresponding kW/A or hp/A values of 1500 r.p.m, 50 Hz or 1800 r.p.m, 60 Hz, 3-phase motors, see "Motor rated operational powers and currents".

(2) For contactors produced since week 49-2011.

General technical data

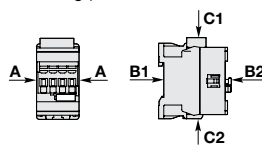
Contactor types	AC / DC operated	AF09	AF12	AF16	AF26	AF30	AF38
Rated insulation voltage Ui							
acc. to IEC 60947-4-1		690 V					
acc. to UL / CSA		600 V					
Rated impulse withstand voltage Uimp.		6 kV					
Electromagnetic compatibility		Devices complying with IEC 60947-1 / EN 60947-1 - Environment A					
Ambient air temperature close to contactor							
Operation	Fitted with thermal overload relay	-25...+60 °C					
	Without thermal overload relay	-40...+70 °C					
Storage		-60...+80 °C					
Climatic withstand		Category B according to IEC 60947-1 Annex Q					
Maximum operating altitude (without derating)		3000 m					
Mechanical durability							
Number of operating cycles		10 millions operating cycles					
Max. switching frequency		3600 cycles/h					
Shock withstand							
acc. to IEC 60068-2-27 and EN 60068-2-27							
Mounting position 1							
		Shock direction					
		1/2 sinusoidal shock for 11 ms: no change in contact position, closed or open position					
		A		30 g			
		B1		25 g closed position / 5 g open position			
		B2		15 g			
		C1		25 g			
C2		25 g					
Vibration withstand							
acc. to IEC 60068-2-6							
		5...300 Hz					
		4 g closed position / 2 g open position					

AF40 ... AF96 3-pole contactors

Technical data

Main pole - Utilization characteristics according to UL / NEMA / CSA

Contactor types	AC / DC operated	AF40	AF52	AF65	AF80	AF96
Standards		UL 60947-1 / 60947-4-1A and CSA 60947-1 / 60947-4-1A				
Maximum operational voltage		600 V				
NEMA size		2	-	-	3	-
NEMA continuous amp rating	Thermal current	45 A	-	-	90 A	-
NEMA maximum horse power ratings						
1-phase, 60 Hz	115 V AC	3 hp	-	-	-	-
	230 V AC	7.5 hp	-	-	-	-
NEMA maximum horse power ratings						
3-phase, 60 Hz	200 V AC	10 hp	-	-	25 hp	-
	230 V AC	15 hp	-	-	30 hp	-
	460 V AC	25 hp	-	-	50 hp	-
	575 V AC	25 hp	-	-	50 hp	-
UL / CSA general use rating						
600 V AC		60 A	80 A	90 A	105 A	115 A
With conductor cross-sectional area		AWG 6	AWG 4	AWG 3	AWG 2	AWG 2
UL / CSA maximum 1-phase motor rating						
Full load current	120 V AC	34 A	34 A	56 A	80 A	80 A
	240 V AC	40 A	50 A	68 A	68 A	88 A
Horse power rating	120 V AC	3 hp	3 hp	5 hp	7-1/2 hp	7-1/2 hp
	240 V AC	7-1/2 hp	10 hp	15 hp	15 hp	20 hp
UL / CSA maximum 3-phase motor rating						
Full load current (1)	200-208 V AC	32.2 A	48.3 A	62.1 A	78.2 A	92 A
	220-240 V AC	42 A	54 A	68 A	80 A	80 A
	440-480 V AC	40 A	52 A	65 A	77 A	77 A
	550-600 V AC	41 A	52 A	62 A	77 A	77 A
Horse power rating (1)	200-208 V AC	10 hp	15 hp	20 hp	25 hp	30 hp
	220-240 V AC	15 hp	20 hp	25 hp	30 hp	30 hp
	440-480 V AC	30 hp	40 hp	50 hp	60 hp	60 hp
	550-600 V AC	40 hp	50 hp	60 hp	75 hp	75 hp
Short-circuit protection device for contactors						
without thermal overload relay - Motor protection excluded						
High fault current		100 kA				
Fuse rating		150 A	150 A	150 A	200 A	200 A
Fuse type, 600 V		J				
Maximum electrical switching frequency						
For general use		600 cycles/h				
For motor use		1200 cycles/h				

(1) For the corresponding kW/A or hp/A values of 1500 r.p.m, 50 Hz or 1800 r.p.m, 60 Hz, 3-phase motors, see "Motor rated operational powers and currents".

General technical data

Contactor types	AC / DC operated	AF40	AF52	AF65	AF80	AF96
Rated insulation voltage Ui		690 V				
acc. to IEC 60947-4-1		600 V				
acc. to UL / CSA		1000 V				
Rated impulse withstand voltage Uimp.		6 kV				
Electromagnetic compatibility		8 kV				
Ambient air temperature close to contactor		Devices complying with IEC 60947-1 / EN 60947-1				
Operation	Fitted with thermal overload relay	(2)				
	Without thermal overload relay	-40...+70 °C				
Storage		-60...+80 °C				
Climatic withstand		Category B according to IEC 60947-1 Annex Q				
Maximum operating altitude (without derating)		3000 m				
Mechanical durability						
Number of operating cycles		10 millions operating cycles				
Maximum switching frequency		3600 cycles/h				
Shock withstand						
acc. to IEC 60068-2-27 and EN 60068-2-27						
Mounting position 1						
	Shock direction	1/2 sinusoidal shock for 11 ms: no change in contact position, closed or open position				

(2) On request.

AF116 ... AF370 3-pole contactors

Technical data

Main pole - Utilization characteristics according to UL / NEMA / CSA

Contactor types	AC / DC operated	AF116	AF140	AF146	AF190	AF205	AF265	AF305	AF370
Standards		UL 60947-1 / 60947-4-1A and CSA 60947-1 / 60947-4-1A							
Maximum operational voltage		600V							
NEMA size		—	4	—	—	—	5	—	—
NEMA continuous amp rating	Thermal current	—	135 A	—	—	—	270 A	—	—
NEMA maximum horse power ratings									
1-phase, 60 Hz									
	115 V AC	—	—	—	—	—	—	—	—
	230 V AC	—	—	—	—	—	—	—	—
NEMA maximum horse power ratings									
3-phase, 60 Hz									
	200 V AC	—	40 hp	—	—	—	75 hp	—	—
	230 V AC	—	50hp	—	—	—	100 hp	—	—
	460 V AC	—	100 hp	—	—	—	200 hp	—	—
	575 V AC	—	100 hp	—	—	—	200 hp	—	—
UL / CSA general use rating									
	600 V AC	160 A	200 A	200 A	230 A	250 A	300 A	350 A	400 A
	600 V AC (w/ LX.. terminal extensions)	160 A	200 A	200 A	250 A	300 A	350 A	400 A	520 A
	With conductor cross-sectional area	AWG 2/0	AWG 3/0	AWG 3/0	MCM 250	MCM 350 (2)	MCM 500	2//AWG 3/0	2//MCM 300
UL / CSA maximum 1-phase motor rating									
	Full load current								
	120 V AC	—	—	—	—	—	—	—	—
	240 V AC	—	—	—	—	—	—	—	—
	Horse power rating	—	—	—	—	—	—	—	—
	120 V AC	—	—	—	—	—	—	—	—
	240 V AC	—	—	—	—	—	—	—	—
UL / CSA maximum 3-phase motor rating									
	Full load current (1)								
	200-208 V AC	92 A	120 A	120 A	150 A	177 A	221 A	285 A	359 A
	220-240 V AC	104 A	130 A	130 A	154 A	192 A	248 A	312 A	360 A
	440-480 V AC	96 A	124 A	124 A	156 A	180 A	240 A	302 A	361 A
	550-600 V AC	99 A	125 A	125 A	144 A	192 A	242 A	289 A	336 A
	Horse power rating (1)								
	200-208 V AC	30 hp	40 hp	40 hp	50 hp	60 hp	75 hp	100 hp	125 hp
	220-240 V AC	40 hp	50 hp	50 hp	60 hp	75 hp	100 hp	125 hp	150 hp
	440-480 V AC	75 hp	100 hp	100 hp	125 hp	150 hp	200 hp	250 hp	300 hp
	550-600 V AC	100 hp	125 hp	125 hp	150 hp	200 hp	250 hp	300 hp	350 hp
Short-circuit protection device for contactors									
	without thermal overload relay - Motor protection excluded								
	High fault current	100 kA							
	Fuse rating	225 A	250 A	250 A	450 A	400 A	500 A	600 A	800 A
	Fuse type, 600 V	J							
Maximum electrical switching frequency									
	For general use	300 cycles/h							
	For motor use	300 cycles/h							

(1) For the corresponding kW/A or hp/A values of 1500 r.p.m, 50 Hz or 1800 r.p.m, 60 Hz, 3-phase motors, see "Motor rated operational powers and currents".

(2) For conductor cross-sectional area above MCM 300 use terminal enlargements LW205.

General technical data

Contactor types	AC / DC operated	AF116	AF140	AF146	AF190	AF205	AF265	AF305	AF370
Rated insulation voltage Ui		1000 V							
	acc. to IEC 60947-4-1	600 V							
	acc. to UL / CSA	600 V							
Rated impulse withstand voltage Uimp.		8 kV							
Electromagnetic compatibility		AF contactors comply with IEC 60947-1 / EN 60947-1 - Environment A							
Ambient air temperature close to contactor									
	Operation								
	Fitted with thermal overload relay	-25 to +55 °C							
	Without thermal overload relay	-40 to +70 °C							
	Storage	-40 to +70 °C							
Maximum operating altitude (without derating)		3000 m							
Mechanical durability									
	Number of operating cycles	5 million operating cycles							
	Maximum switching frequency	300 cycles/h							

AF400 ... AF2650 3-pole contactors

Technical data

Main pole - Utilization characteristics according to UL / NEMA / CSA

Contactor types	AC / DC operated	AF400	AF460	AF580	AF750	AF1250	AF1350	AF1650	AF2050	AF2650
Standards		UL 60947-1 / 60947-4-1A and CSA 60947-1 / 60947-4-1A								
Maximum operational voltage		600 V								
NEMA size		-	6	-	7	-	-	8	-	-
NEMA maximum horse power ratings										
1-phase, 60 Hz	115 V AC	-	-	-	-	-	-	-	-	-
	230 V AC	-	-	-	-	-	-	-	-	-
NEMA maximum horse power ratings										
3-phase, 60 Hz	200 V AC	-	150 hp	-	-	-	-	-	-	-
	230 V AC	-	200 hp	-	300 hp	-	-	450 hp	-	-
	460 V AC	-	400 hp	-	600 hp	-	-	900 hp	-	-
	575 V AC	-	400 hp	-	600 hp	-	-	900 hp	-	-
UL / CSA general use rating										
600 V AC		550 A	650 A	750 A	900 A	1210 A	1350 A	1650 A	2100 A	2700 A
UL / CSA maximum 1-phase motor rating										
Full load current	120 V AC	-	-	-	-	-	-	-	-	-
	240 V AC	-	-	-	-	-	-	-	-	-
Horse power rating	120 V AC	-	-	-	-	-	-	-	-	-
	240 V AC	-	-	-	-	-	-	-	-	-
UL / CSA maximum 3-phase motor rating										
Full load current (1)	200-208 V AC	358.8 A	414 A	552 A	692.3 A	-	-	954 A	1030 A	-
	220-240 V AC	360 A	480 A	604 A	722 A	-	-	954 A	1030 A	-
	440-480 V AC	414 A	477 A	590 A	722 A	-	-	954 A	1030 A	-
	550-600 V AC	382 A	472 A	578 A	672 A	-	-	944 A	1050 A	-
Horse power rating (1)	200-208 V AC	125 hp	150 hp	200 hp	250 hp	-	-	-	-	-
	220-240 V AC	150 hp	200 hp	250 hp	300 hp	-	-	400 hp	450 hp	-
	440-480 V AC	350 hp	400 hp	500 hp	600 hp	-	-	800 hp	900 hp	-
	550-600 V AC	400 hp	500 hp	600 hp	700 hp	-	-	1000 hp	1150 hp	-
Short-circuit protection device for contactors										
without thermal overload relay - Motor protection excluded										
Fuse rating		1000 A		1200 A		Please consult us for coordination with circuit-breaker				
Fuse type, 600 V		L								
Maximum electrical switching frequency										
For general use		300 cycles/h				60 cycles/h			15 cycles/h	
For motor use		300 cycles/h				60 cycles/h			-	

(1) For the corresponding kW/A or hp/A values of 1500 r.p.m, 50 Hz or 1800 r.p.m, 60 Hz, 3-phase motors, see "Motor rated operational powers and currents".

General technical data

Contactor types	AC / DC operated	AF400	AF460	AF580	AF750	AF1250	AF1350	AF1650	AF2050	AF2650
Rated insulation voltage Ui										
acc. to IEC 60947-4-1		1000 V								
acc. to UL		600 V								
Rated impulse withstand voltage Uimp.		8 kV								
Electromagnetic compatibility		AF contactors complying with IEC 60947-1 / EN 60947-1 - Environment A								
Ambient air temperature close to contactor										
Operation	Fitted with electronic overload relay	-25 to +70 °C								
	Without electronic overload relay	-40 to +70 °C								
Storage		-40 to +70 °C								
Maximum operating altitude (without derating)		3000 m								
Mechanical durability										
Number of operating cycles		3 millions operating cycles				0.5 million operating cycles			0.3 million operating cycles	
Max. switching frequency		300 cycles/h				60 cycles/h				
Shock withstand										
acc. to IEC 60068-2-27 and EN 60068-2-27										
Mounting position 1										
Shock direction		1/2 sinusoidal shock for 30 ms: no change in contact position, closed or open position								
A		5 g								
B1		5 g								
B2		5 g								
C1		5 g								
C2		5 g								

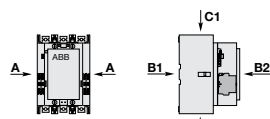

AF09 ... AF38 3-pole contactors

Technical data

Magnet system characteristics

Contactor types	AC / DC operated	AF09	AF12	AF16	AF26	AF30	AF38
Coil operating limits acc. to IEC 60947-4-1	AC supply	At $\theta \leq 60\text{ °C}$ $0.85 \times U_c \text{ min...} 1.1 \times U_c \text{ max.}$ At $\theta \leq 70\text{ °C}$ $0.85 \times U_c \text{ min...} U_c \text{ max.}$					
	DC supply	At $\theta \leq 60\text{ °C}$ $0.85 \times U_c \text{ min...} 1.1 \times U_c \text{ max.}$ At $\theta \leq 70\text{ °C}$ (AF) $0.85 \times U_c \text{ min...} U_c \text{ max.}$ - (AF..Z) $0.85 \times U_c \text{ min...} 1.1 \times U_c \text{ max.}$					
AC control voltage 50/60 Hz		24...500 V AC					
Rated control circuit voltage U_c Coil consumption	Average pull-in value	(AF) 50 VA - (AF..Z) 16 VA					
	Average holding value	(AF) 2.2 VA / 2 W - (AF..Z) 1.7 VA / 1.5 W					
DC control voltage		12...500 V DC					
Rated control circuit voltage U_c Coil consumption	Average pull-in value	(AF) 50 W - (AF..Z) 12...16 W					
	Average holding value	(AF) 2 W - (AF..Z) 1.7 W					
PLC-output control		(AF..Z) $\geq 500\text{ mA}$ 24 V DC					
Drop-out voltage		$\leq 60\%$ of $U_c \text{ min.}$					
Voltage sag immunity acc. to SEMI F47-0706		(AF..Z) conditions of use on request					
Dips withstand $-20\text{ °C} \leq \leq +60\text{ °C}$		(AF..Z) 22 ms average for $U_c \geq 24\text{ V}$ 50/60 Hz or $U_c \geq 20\text{ V}$ DC					
Operating time	Between coil energization and:	N.O. contact closing	40...95 ms				
		N.C. contact opening	38...90 ms				
	Between coil de-energization and:	N.O. contact opening	11...95 ms				
		N.C. contact closing	13...98 ms				

Mounting characteristics and conditions for use

Contactor types	AC / DC operated	AF09	AF12	AF16	AF26	AF30	AF38
Mounting positions							
Mounting distances		Max. N.C. built-in and add-on N.C. auxiliary contacts: see accessory fitting details for a 3-pole contactor AF09 ... AF38					
Fixing		The contactors can be assembled side by side					
On rail according to IEC 60715, EN 60715 By screws (not supplied)		35 x 7.5 mm or 35 x 15 mm					
		2 x M4 screws placed diagonally					

AF40 ... AF96 3-pole contactors

Technical data

Magnet system characteristics

Contactor types	AC / DC operated	AF40	AF52	AF65	AF80	AF96
Coil operating limits acc. to IEC 60947-4-1	AC supply	At $\theta \leq 70^\circ\text{C}$ $0.85 \times U_c \text{ min} \dots 1.1 \times U_c \text{ max.}$				
	DC supply	At $\theta \leq 70^\circ\text{C}$ $0.85 \times U_c \text{ min} \dots 1.1 \times U_c \text{ max.}$				
AC control voltage 50/60 Hz						
Rated control circuit voltage U_c		24...500 V AC				
Coil consumption	Average pull-in value	25 VA				40 VA
	Average holding value	4 VA / 2 W				
DC control voltage						
Rated control circuit voltage U_c		20...500 V DC				
Coil consumption	Average pull-in value	25 W				40 W
	Average holding value	2 W				
PLC-output control		-				
Drop-out voltage		$\leq 60\%$ of $U_c \text{ min.}$				
Voltage sag immunity acc. to SEMI F47-0706		conditions of use on request				
Dips withstand $-20^\circ\text{C} \leq \theta \leq +60^\circ\text{C}$		24 ms average				
Operating time						
Between coil energization and:	N.O. contact closing	42...100 ms				
	N.C. contact opening	38...95 ms				
Between coil de-energization and:	N.O. contact opening	17...100 ms				
	N.C. contact closing	19...105 ms				

Mounting characteristics and conditions for use

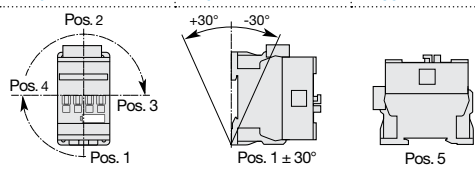
Contactor types	AC / DC operated	AF40	AF52	AF65	AF80	AF96
Mounting positions						
Mounting distances		Max. N.C. built-in and add-on N.C. auxiliary contacts: see accessory fitting details for a 3-pole contactor AF40 ... AF96				
Fixing		The contactors can be assembled side by side				
On rail according to IEC 60715, EN 60715		35 x 7.5 mm or 35 x 15 mm				35 x 15 mm
	By screws (not supplied)	2 x M4 or 2 x M6 screws placed diagonally				

AF116 ... AF370 3-pole contactors

Technical data

Magnet system characteristics

Contactor types	AC / DC operated	AF116	AF140	AF146	AF190	AF205	AF265	AF305	AF370
Coil operating limits	AC supply	At $\theta \leq 70^\circ\text{C}$ $0.85 \times U_c \text{ min} \dots 1.1 \times U_c \text{ max}$							
acc. to IEC 60947-4-1	DC supply	At $\theta \leq 70^\circ\text{C}$ $0.80 \times U_c \text{ min} \dots 1.1 \times U_c \text{ max}$							
Rated control circuit voltage U_c									
Coil consumption									
AC control voltage 50/60 Hz									
24...60 V AC	Average pull-in value	225 VA			165 VA		475 VA		
	Average holding value	5.5 VA			6 VA		8.5 VA		
48...130 V AC	Average pull-in value	170 VA			175 VA		340 VA		
	Average holding value	4 VA			4 VA		17 VA		
100...250 V AC	Average pull-in value	130 VA			220 VA		385 VA		
	Average holding value	6 VA			7 VA		17.5 VA		
250...500 V AC	Average pull-in value	200 VA			200 VA		400 VA		
	Average holding value	18 VA			18 VA		20 VA		
DC control voltage									
20...60 V DC	Average pull-in value	210 W			205 W		400 W		
	Average holding value	2.5 W			2.5 W		3 W		
48...130 V DC	Average pull-in value	130 W			130 W		360 W		
	Average holding value	2.5 W			2.5 W		2.5 W		
100...250 V DC	Average pull-in value	135 W			190 W		410 W		
	Average holding value	3 W			2.5 W		4.5 W		
250...500 V DC	Average pull-in value	180 W			160 W		270 W		
	Average holding value	3.5 W			3.5 W		4 W		
Drop-out voltage		55 % of $U_c \text{ min}$							
Operating time									
Coil supply between A1 - A2									
Between coil energization and:	N.O. contact closing	20...55 ms			25...60 ms		30...60 ms		
Between coil de-energization and:	N.O. contact opening	40...70 ms			45...80 ms		45...80 ms		

Mounting characteristics and conditions for use

Contactor types	AC / DC operated	AF116	AF140	AF146	AF190	AF205	AF265	AF305	AF370
Mounting positions									
		Max. add-on N.O. or N.C. auxiliary contacts: see accessory fitting details for 3-pole contactor AF116 ... AF370							
Mounting distances									
		The contactors can be assembled side by side							
Fixing									
On rail acc. to IEC 60715, EN 60715		-							
By screws (not supplied)		4 x M5							

AF400 ... AF2650 3-pole contactors

Technical data

Magnet system characteristics

Contactor types	AC / DC operated	AF400	AF460	AF580	AF750	AF1250	AF1350	AF1650	AF2050	AF2650	
Coil operating limits	AC supply	At $\theta \leq 70^\circ\text{C}$ $0.85 \times U_c \text{ min} \dots 1.1 \times U_c \text{ max}$									
acc. to IEC 60947-4-1	DC supply	At $\theta \leq 70^\circ\text{C}$ $0.80 \times U_c \text{ min} \dots 1.1 \times U_c \text{ max}$									
Rated control circuit voltage U_c											
Coil consumption											
AC control voltage 50/60 Hz											
24...60 V AC	Average pull-in value	900 VA		780 VA		-					
	Average holding value	12 VA		12 VA		-					
48...130 V AC	Average pull-in value	1215 VA		1100 VA		-					
	Average holding value	12 VA		12 VA		-					
100...250 V AC	Average pull-in value	955 VA		880 VA		2450 VA		-			
	Average holding value	12 VA		12 VA		48 VA		-			
250 ... 500 V AC	Average pull-in value	950 VA		985 VA		-					
	Average holding value	12 VA		12 VA		-					
DC control voltage											
20...60 V DC	Average pull-in value	900 VA		785 VA		-					
	Average holding value	5 VA		5.5 VA		-					
48...130 V DC	Average pull-in value	1150 VA		1020 VA		-					
	Average holding value	5 VA		5 VA		-					
100...250 V DC	Average pull-in value	895 VA		880 VA		2290 VA		-			
	Average holding value	5 VA		5 VA		20.5 VA		-			
250 ... 500 V AC	Average pull-in value	885 VA		910 VA		-					
	Average holding value	7.5 VA		7.5 VA		-					
Drop-out voltage	55 % of $U_c \text{ min.}$										
Voltage sag immunity	Conditions of use on request										
acc. to SEMI F47											
Dips withstand	$\geq 20 \text{ ms}$										
Operating time											
Coil supply between A1 - A2											
Between coil energization and:	Main contact closing	50...120 ms				50...80 ms		-			
Between coil de-energization and:	Main contact opening	33...70 ms				35...55 ms		-			
Control input for PLC's											
Between coil energization and:	Main contact closing	40...60 ms		40...90 ms		40...65 ms		-			
Between coil de-energization and:	Main contact opening	10...30 ms				10...30 ms		-			















Mounting characteristics and conditions for use

Contactor types	AC / DC operated	AF400	AF460	AF580	AF750	AF1250	AF1350	AF1650	AF2050	AF2650
Mounting positions										
Max. add-on N.O. or N.C. auxiliary contacts: see accessory fitting details for 3-pole contactor AF400 ... AF2650										
Mounting distances										
The contactors can be assembled side by side										
Fixing										
On rail according to IEC 60715, EN 60715										
By screws (not supplied)										
		4 x M5		4 x M6		4 x M8				

AF09 ... AF38 3-pole contactors

Technical data











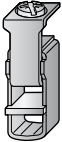
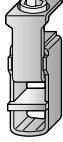



Connecting characteristics

Contactor types	AC / DC operated	AF09	AF12	AF16	AF26	AF30	AF38
Main terminals		 <p>Screw terminals with cable clamp</p>					
Connection capacity (min. ... max.)							
Main conductors (poles)							
	Rigid	Solid ($\leq 4 \text{ mm}^2$)	} 1 x	1...6 mm ²		2.5...10 mm ²	
		Stranded ($\geq 6 \text{ mm}^2$)		2 x	1...6 mm ²		2.5...10 mm ²
	Flexible with non insulated ferrule		1 x	0.75...6 mm ²		1.5...10 mm ²	
			2 x	0.75...6 mm ²		1.5...10 mm ²	
	Flexible with insulated ferrule		1 x	0.75...4 mm ²		1.5...10 mm ²	
			2 x	0.75...2.5 mm ²		1.5...4 mm ²	
	Bars or lugs		L <	9.6 mm		12.5 mm	
Connection capacity acc. to UL/CSA			1 or 2 x	AWG 16...10		AWG 14...8	
Stripping length				10 mm		14 mm	
Tightening torque				1.5 Nm / 13 lb.in		2.5 Nm / 22 lb.in	
Auxiliary conductors							
(built-in auxiliary terminals + coil terminals)							
	Rigid solid		1 x	1...2.5 mm ²			
			2 x	1...2.5 mm ²			
	Flexible with non insulated ferrule		1 x	0.75...2.5 mm ²			
			2 x	0.75...2.5 mm ²			
	Flexible with insulated ferrule		1 x	0.75...2.5 mm ²			
			2 x	0.75...1.5 mm ²			
	Lugs		L <	8 mm			
Connection capacity acc. to UL/CSA			1 or 2 x	AWG 18...14			
Stripping length				10 mm			
Tightening torque							
Coil terminals				1.2 Nm / 11 lb.in			
Built-in auxiliary terminals				1.2 Nm / 11 lb.in			
Degree of protection							
acc. to IEC 60947-1 / EN 60947-1 and IEC 60529 / EN 60529							
Main terminals		IP20					
Coil terminals		IP20					
Built-in auxiliary terminals		IP20					
Screw terminals		Delivered in open position, screws of unused terminals must be tightened					
Main terminals		M3.5			M4		
		Screwdriver type		Flat Ø 5.5 / Pozidriv 2		Flat Ø 6.5 / Pozidriv 2	
Coil terminals		M3.5					
		Screwdriver type		Flat Ø 5.5 / Pozidriv 2			
Built-in auxiliary terminals		M3.5					
		Screwdriver type		Flat Ø 5.5 / Pozidriv 2			

AF40 ... AF96 3-pole contactors

Technical data

Connecting characteristics

Contactor types	AC / DC operated	AF40	AF52	AF65	AF80	AF96
Main terminals						
		Screw terminals with double connector 2 x (9.3 width x 7.9/10.3 depth)			Screw terminals with double connector 2 x (12.4 width x 9.3/11.1 depth)	
Connection capacity (min. ... max.)						
Main conductors (poles)						
 Rigid	Solid ($\leq 4 \text{ mm}^2$)	} 1 x	6...35 mm ²			6...70 mm ²
 Stranded ($\geq 6 \text{ mm}^2$)			2 x 6...35 mm ²			6...50 mm ²
 Flexible with non insulated ferrule		1 x	4...35 mm ²			6...50 mm ²
 Flexible with insulated ferrule		2 x	4...35 mm ²			6...50 mm ²
 Flexible with insulated ferrule		1 x	4...35 mm ²			6...50 mm ²
 Flexible with insulated ferrule		2 x	4...35 mm ²			6...50 mm ²
 Bars or lugs		L <	9.2 mm			12.2 mm
Connection capacity acc. to UL/CSA		1 or 2 x	AWG 10...2			AWG 6...1
Stripping length			16 mm			17 mm
Tightening torque			4 Nm / 35 lb.in			6 Nm / 53 lb.in
Auxiliary conductors (built-in auxiliary terminals + coil terminals)						
 Rigid solid		1 x	1...2.5 mm ²			
 Rigid solid		2 x	1...2.5 mm ²			
 Flexible with non insulated ferrule		1 x	0.75...2.5 mm ²			
 Flexible with non insulated ferrule		2 x	0.75...2.5 mm ²			
 Flexible with insulated ferrule		1 x	0.75...2.5 mm ²			
 Flexible with insulated ferrule		2 x	0.75...1.5 mm ²			
 Lugs		L <	8 mm			
Connection capacity acc. to UL/CSA		1 or 2 x	AWG 18...14			
Stripping length			10 mm			
Tightening torque			1.2 Nm / 11 lb.in			
Coil terminals			1.2 Nm / 11 lb.in			
Built-in auxiliary terminals			1.2 Nm / 11 lb.in			
Degree of protection acc. to IEC 60947-1 / EN 60947-1 and IEC 60529 / EN 60529						
Main terminals			IP10			
Coil terminals			IP20			
Built-in auxiliary terminals			IP20			
Screw terminals						
Main terminals			Delivered in open position, screws of unused terminals must be tightened			
		Screwdriver type	M6			M8
Coil terminals		Screwdriver type	Flat Ø 6.5 / Pozidriv 2			Hexagon socket (s = 4 mm)
		Screwdriver type	M3.5			
Built-in auxiliary terminals		Screwdriver type	Flat Ø 5.5 / Pozidriv 2			
		Screwdriver type	M3.5			
		Screwdriver type	Flat Ø 5.5 / Pozidriv 2			

AF116 ... AF370 3-pole contactors

Technical data

Connecting characteristics

Contactor types	AC / DC operated	AF116	AF140	AF146	AF190	AF205	AF265	AF305	AF370
Main terminals									
Flat type									
Connection capacity (min. ... max.)									
Main conductors (poles)									
	Cu cable - Stranded	1 x	10...95 mm ²		6...150 mm ²		16...300 mm ²		
	Clamp type		LD... included (1)		1SDA066917R1		1SDA055016R1		
	Tightening torque		8 Nm		14 Nm		25 Nm		
	Cu cable - Stranded	2 x	10...95 mm ²		50...120 mm ²		70...185 mm ²		
	Clamp type		LD... included (1)		1SFN074709R1000, LZ185-2C/120		1SCA022194R0890, OZXB4		
	Tightening torque		8 Nm		16 Nm		22 Nm		
	Al cable - Stranded	1 x	-		95...185 mm ²		185...240 mm ²		
	Clamp type		-		1SDA054988R1		1SDA055020R1		
	Tightening torque		-		31 Nm		43 Nm		
	Cu cable - Flexible	1 x	10...70 mm ²		6...120 mm ²		16...240 mm ²		
	Clamp type		LD... included (1)		1SDA066917R1		1SDA055016R1		
	Tightening torque		8 Nm		14 Nm		25 Nm		
	Cu cable - Flexible	2 x	10...70 mm ²		50...95 mm ²		70...185 mm ²		
	Clamp type		LD... included (1)		1SFN074709R1000, LZ185-2C/120		1SCA022194R0890, OZXB4		
	Tightening torque		8 Nm		16 Nm		22 Nm		
	Lugs	W ≤	22 mm (.866 in)		24 mm (.945 in)		32 mm (1.260 in)		
		Ø >	6 mm (.236 in)		8 mm (.315 in)		10 mm (.394 in)		
	Socket type		LL... included		LL... included		LL... included		
	Tightening torque		9 Nm / 80 lb.in		18 Nm / 160 lb.in		28 Nm / 248 lb.in		
Connection capacity acc. to UL / CSA		1 x	AWG 6...3/0		6...300 MCM		4...400 MCM		
	Clamp type		LD... included (1)		ATK185 (2)		ATK300 (2)		
	Tightening torque		8 Nm / 71 lb.in		34 Nm / 301 lb.in		42 Nm / 372 lb.in		
Connection capacity acc. to UL / CSA		2 x	AWG 6...3/0		-		4...500 MCM		
	Clamp type		LD... included (1)		-		ATK300/2 (2)		
	Tightening torque		8 Nm / 71 lb.in		-		42 Nm / 372 lb.in		
Auxiliary conductors									
(coil terminals)									
	Solid / stranded	1 x	1...4 mm ²						
	Flexible	2 x	1...4 mm ²						
	Flexible	1 x	0.75...2.5 mm ²						
	Flexible	2 x	0.75...2.5 mm ²						
	Flexible with non insulated ferrule	1 x	0.75...2.5 mm ²						
	Flexible	2 x	0.75...2.5 mm ²						
	Flexible with insulated ferrule	1 x	0.75...2.5 mm ²						
	Flexible	2 x	0.75...2.5 mm ²						
	Lugs	L <	8 mm						
		L >	3.5 mm						
Connection capacity acc. to UL / CSA		1 or 2 x	AWG 18...14						
	Stripping length		9 mm						
	Tightening torque		1.00 Nm / 9 lb.in						
Degree of protection									
acc. to IEC 60947-1 / EN 60947-1 and IEC 60529 / EN 60529									
Main terminals			IP00						
Coil terminals			IP20						
Screw terminals									
Main terminals			M6		M8		M10		
	Screwdriver type		Screws and bolts						
Coil terminals (delivered in open position)			M3.5						
	Screwdriver type		Flat Ø 5.5 mm / Pozidriv 2						

(1) LD... not included for AF116 ... AF146-30...B.

(2) Available in North America only.

AF400 ... AF2650 3-pole contactors

Technical data

Connecting characteristics

Contactor types	AC / DC operated	AF400	AF460	AF580	AF750	AF1250	AF1350	AF1650	AF2050	AF2650	
Main terminals											
Flat type											
Connection capacity (min. ... max.)											
Main conductors (poles)											
	Cu cable - Stranded	2 x	240 mm ²		-		-				
	Clamp type		1SDA013922R1		-		-				
	Tightening torque		35 Nm		-		-				
	Cu cable - Stranded	3 x	-	185 mm ²		-		-			
	Clamp type		-	1SDA013956R1		-		-			
	Tightening torque		35 Nm	45 Nm		-		-			
	Al cable - Stranded	2 x	240 mm ²		-		-				
	Clamp type		1SDA013922R1		-		-				
	Tightening torque		35 Nm		-		-				
		3 x	-	185 mm ²		-		-			
	Clamp type		-	1SDA013956R1		-		-			
	Tightening torque		35 Nm	45 Nm		-		-			
	Lugs	W ≤	47 mm		50 mm		100 mm				
		Ø >	10 mm		12 mm						
	Tightening torque		35 Nm / 310 lb.in		45 Nm / 398 lb.in						
Connection capacity acc. to UL / CSA											
		2 x	250-500 MCM alt. 2/0 AWG-400 MCM		-		2// 3 x 0.25 in bars, use LW1250		4/0 AWG - 500 MCM		4//4 x 0.25 in
	Clamp type		K6TH alt. ATK580		-		K7TK		K7TK		bars
	Tightening torque		275 lb.in		-		375 lb.in		-		-
Connection capacity acc. to UL / CSA											
		3 x	2/0 AWG-400 MCM		2/0 AWG-500 MCM		1/0-750 MCM		-		-
	Clamp type		K6TJ		ATK750/3		K8TL, K8TM, ATK1650/4		K8TL, K8TM, ATK1650/4, ATK1650/6		-
	Tightening torque		275 lb.in		375 lb.in		500 lb.in		-		-
Auxiliary conductors (coil terminals)											
	Solid / stranded	1 x	1...4 mm ²		-		-				
		2 x	1...4 mm ²		-		-				
	Flexible	1 x	0.75...2.5 mm ²		-		-				
		2 x	0.75...2.5 mm ²		-		-				
	Flexible with non insulated ferrule	1 x	0.75...2.5 mm ²		-		-				
		2 x	0.75...2.5 mm ²		-		-				
	Flexible with insulated ferrule	1 x	0.75...2.5 mm ²		-		-				
		2 x	0.75...2.5 mm ²		-		-				
	Lugs	L ≤	8 mm		-		-				
		L >	3.7 mm		-		-				
Connection capacity acc. to UL / CSA											
		1 or 2 x	AWG 18...14		-		-				
	Tightening torque	Recommended	1.00 Nm / 9 lb.in		-		-				
		Max.	1.20 Nm		-		-				
Degree of protection											
acc. to IEC 60947-1 / EN 60947-1 and IEC 60529 / EN 60529											
Main terminals											
IP00											
Coil terminals											
IP20											
Screw terminals											
Main terminals											
M10											
Screws and bolts											
M12											
Coil terminals (delivered in open position)											
M3.5											
Screwdriver type											
Flat Ø 5.5 mm / Pozidriv 2											

2

AF09 ... AF96 3-pole contactors

Technical data

Built-in auxiliary contacts according to IEC

Contactor types	AC / DC operated	AF09	AF12	AF16	AF26	AF30	AF38	AF40	AF52	AF65	AF80	AF96
Rated operational voltage U _e max.		690 V										
Rated frequency (without derating)		50 / 60 Hz										
Conventional free air thermal current I _{th} - θ ≤ 40 °C		16 A										
le / Rated operational current AC-15 acc. to IEC 60947-5-1	24-127 V 50/60 Hz	6 A										
	220-240 V 50/60 Hz	4 A										
	400-440 V 50/60 Hz	3 A										
	500 V 50/60 Hz	2 A										
	690 V 50/60 Hz	2 A										
Making capacity AC-15		10 x I _e AC-15 acc. to IEC 60947-5-1										
Breaking capacity AC-15		10 x I _e AC-15 acc. to IEC 60947-5-1										
le / Rated operational current DC-13 acc. to IEC 60947-5-1	24 V DC	6 A / 144 W										
	48 V DC	2.8 A / 134 W										
	72 V DC	1 A / 72 W										
	110 V DC	0.55 A / 60 W										
	125 V DC	0.55 A / 69 W										
	220 V DC	0.27 A / 60 W										
	250 V DC	0.27 A / 68 W										
	400 V DC	0.15 A / 60 W										
	500 V DC	0.13 A / 65 W										
	600 V DC	0.1 A / 60 W										
Short-circuit protection device gG type fuse		10 A										
Rated short-time withstand current I _{ow}	for 1.0 s	100 A										
	for 0.1 s	140 A										
Minimum switching capacity with failure rate acc. to IEC 60947-5-4		12 V / 3 mA										
Non-overlapping time between N.O. and N.C. contacts		10 ⁻⁷										
Power dissipation per pole at 6 A		≥ 2 ms										
Max. electrical switching frequency	AC-15	0.1 W										
	DC-13	1200 cycles/h										
		900 cycles/h										
Mechanically linked contacts acc. to annex L of IEC 60947-5-1		Built-in N.O. or N.C. auxiliary contacts and additional N.O. or N.C. auxiliary contacts (CA4, CAL4, CAT4 aux. contact blocks) are mechanically linked contacts.										
Mirror contacts acc. to annex F of IEC 60947-4-1		Built-in N.C. auxiliary contacts or additional N.C. auxiliary contacts (CA4, CAL4, CAT4 aux. contact blocks) are mirror contacts.										



Built-in auxiliary contacts according to UL / CSA

Contactor types	AC / DC operated	AF09	AF12	AF16	AF26	AF30	AF38	AF40	AF52	AF65	AF80	AF96
Max. operational voltage		600 V AC, 600 V DC										
Pilot duty		A600, Q600										
AC thermal rated current		10 A										
AC maximum volt-ampere making		7200 VA										
AC maximum volt-ampere breaking		720 VA										
DC thermal rated current		2.5 A										
DC maximum volt-ampere making-breaking		69 VA										

AF09 ... AF38 4-pole contactors

Technical data

Main pole - Utilization characteristics according to IEC

Contactors types	AC / DC operated	AF09	AF16	AF26	AF38
Standards		IEC 60947-1 / 60947-4-1 and EN 60947-1 / 60947-4-1			
Rated operational voltage U_e max.		690 V			
Rated frequency (without derating)		50 / 60 Hz			
2 Conventional free-air thermal current I_{th}					
acc. to IEC 60947-4-1, open contactors, $\theta \leq 40^\circ\text{C}$		35 A	35 A	55 A	55 A
With conductor cross-sectional area		6 mm ²	6 mm ²	16 mm ²	16 mm ²
AC-1 Utilization category					
For air temperature close to contactor					
I_e / Rated operational current AC-1	$\theta \leq 40^\circ\text{C}$	25 A	30 A	45 A	55 A
U_e max. ≤ 690 V, 50/60 Hz	$\theta \leq 60^\circ\text{C}$	25 A	30 A	40 A	45 A
	$\theta \leq 70^\circ\text{C}$	22 A	26 A	32 A	37 A
With conductor cross-sectional area		4 mm ²	6 mm ²	10 mm ²	16 mm ²
AC-3 Utilization category					
For air temperature close to contactor $\theta \leq 60^\circ\text{C}$					
I_e / Max. rated operational current AC-3 (1)					
	220-230-240 V	9 A	18 A	23.2 A	23.2 A
	380-400 V	9 A	18 A	22 A	22 A
	415 V	9 A	18 A	21.2 A	21.2 A
	440 V	9 A	18 A	20 A	20 A
	500 V	9.5 A	15 A	17.6 A	17.6 A
	690 V	7 A	10.5 A	10.5 A	10.5 A
 3-phase motors					
Rated operational power AC-3 (1)					
	220-230-240 V	2.2 kW	4 kW	5.5 kW	5.5 kW
	380-400 V	4 kW	7.5 kW	11 kW (2)	11 kW (2)
	415 V	4 kW	9 kW	11 kW	11 kW
	440 V	4 kW	9 kW	11 kW	11 kW
	500 V	5.5 kW	9 kW	11 kW	11 kW
	690 V	5.5 kW	9 kW	9 kW	9 kW
 1500 r.p.m. 50 Hz 1800 r.p.m. 60 Hz 3-phase motors					
Rated making capacity AC-3		10 x I_e AC-3 acc. to IEC 60947-4-1			
Rated breaking capacity AC-3		8 x I_e AC-3 acc. to IEC 60947-4-1			
Short-circuit protection device for contactors					
Without thermal overload relay - Motor protection excluded					
$U_e \leq 500$ V AC - gG type fuse		25 A	32 A	50 A	63 A
Rated short-time withstand current I_{cw}					
At 40 °C ambient temperature, in free air from a cold state					
	1 s	300 A	300 A	450 A	450 A
	10 s	150 A	150 A	300 A	300 A
	30 s	80 A	80 A	225 A	225 A
	1 min	60 A	60 A	150 A	150 A
	15 min	35 A	35 A	55 A	55 A
Power dissipation per pole					
	I_e / AC-1	0.8 W	1.2 W	1.6 W	2.3 W
	I_e / AC-3	0.1 W	0.35 W	0.42 W	0.42 W
Max. electrical switching frequency					
	AC-1	600 cycles/h			
	AC-3	600 cycles/h			

(1) For the corresponding kW/A or hp/A values of 1500 r.p.m. 50 Hz or 1800 r.p.m. 60 Hz, 3-phase motors, see "Motor rated operational powers and currents".

(2) 400V 3-phase motor only.

Main pole - Utilization characteristics according to UL / CSA

Contactors types	AC / DC operated	AF09	AF16	AF26	AF38
Standards		UL 60947-1 / 60947-4-1A and CSA 60947-1 / 60947-4-1A			
Max. operational voltage		600 V			
UL / CSA general use rating					
600 V AC		25 A	30 A	45 A	55 A
With conductor cross-sectional area		AWG 10	AWG 10	AWG 8	AWG 6
Max. electrical switching frequency					
For general use		600 cycles/h			

Note: 4-pole contactors fitted with 2 N.O. + 2 N.C. main poles, see "General technical data".

AF09 ... AF38 4-pole contactors

Technical data

Magnet system characteristics

Contactor types	AC / DC operated	AF09	AF16	AF26	AF38
Coil operating limits acc. to IEC 60947-4-1	AC supply	At $\theta \leq 60\text{ }^\circ\text{C}$ $0.85 \times U_c \text{ min} \dots 1.1 \times U_c \text{ max.}$ At $\theta \leq 70\text{ }^\circ\text{C}$ $0.85 \times U_c \text{ min} \dots U_c \text{ max.}$			
	DC supply	At $\theta \leq 60\text{ }^\circ\text{C}$ $0.85 \times U_c \text{ min} \dots 1.1 \times U_c \text{ max.}$ At $\theta \leq 70\text{ }^\circ\text{C}$ (AF) $0.85 \times U_c \text{ min} \dots U_c \text{ max.}$ - (AF..Z) $0.85 \times U_c \text{ min} \dots 1.1 \times U_c \text{ max.}$			
AC control voltage 50/60 Hz		24...500 V AC			
Rated control circuit voltage U_c		24...500 V AC			
Coil consumption	Average pull-in value	(AF) 50 VA - (AF..Z) 16 VA			
	Average holding value	(AF) 2.2 VA / 2 W - (AF..Z) 1.7 VA / 1.5 W			
DC control voltage		12...500 V DC			
Rated control circuit voltage U_c		12...500 V DC			
Coil consumption	Average pull-in value	(AF) 50 W - (AF..Z) 12...16 W			
	Average holding value	(AF) 2 W - (AF..Z) 1.7 W			
PLC-output control		(AF..Z) $\geq 500\text{ mA}$ 24 V DC			
Drop-out voltage		$\leq 60\%$ of $U_c \text{ min.}$			
Voltage sag immunity acc. to SEMI F47-0706		(AF..Z) conditions of use on request			
Dips withstand $-20\text{ }^\circ\text{C} \leq \dots \leq +60\text{ }^\circ\text{C}$		(AF..Z) 22 ms average for $U_c \geq 24\text{ V}$ 50/60 Hz or $U_c \geq 20\text{ V}$ DC			
Operating time					
Between coil energization and:	N.O. contact closing	40...95 ms			
	N.C. contact opening	38...90 ms			
Between coil de-energization and:	N.O. contact opening	11...95 ms			
	N.C. contact closing	13...98 ms			

Mounting characteristics and conditions for use

Contactor types	AF09	AF16	AF26	AF38
Mounting positions				
Mounting distances	Max. add-on N.C. auxiliary contacts: see accessory fitting details for a 4-pole contactor AF09 ... AF38			
Fixing	The contactors can be assembled side by side			
On rail according to IEC 60715, EN 60715	35 x 7.5 mm or 35 x 15 mm			
By screws (not supplied)	2 x M4 screws placed diagonally			

AF09 ... AF38 4-pole contactors

Technical data

2

General technical data

Contactor types	AC / DC operated	AF09	AF16	AF26	AF38
Rated insulation voltage U_i					
acc. to IEC 60947-4-1		690 V			
acc. to UL / CSA		600 V			
Rated impulse withstand voltage U_{imp}		6 kV			
Electromagnetic compatibility		Devices complying with IEC 60947-1 / EN 60947-1 - Environment A			
Ambient air temperature close to contactor					
Operation		-40...+70 °C			
Storage		-60...+80 °C			
Climatic withstand		Category B according to IEC 60947-1 Annex Q			
Maximum operating altitude (without derating)		3000 m			
Mechanical durability					
Number of operating cycles		10 millions operating cycles			
Max. switching frequency		3600 cycles/h			
Shock withstand					
acc. to IEC 60068-2-27 and EN 60068-2-27					
Mounting position 1					
	Shock direction	1/2 sinusoidal shock for 11 ms: no change in contact position, closed or open position			
	4 N.O. Main poles	A	30 g		
		B1	25 g closed position / 5 g open position		
		B2	15 g		
		C1	25 g		
		C2	25 g		
	2 N.O. + 2 N.C. Main poles	A	30 g closed position / 25 g open position		
		B1	25 g closed position / 5 g open position		
		B2	15 g closed position / 10 g open position		
		C1	25 g closed position / 20 g open position		
		C2	25 g closed position / 20 g open position		
Vibration withstand					
acc. to IEC 60068-2-6		5...300 Hz			
		4 g closed position / 2 g open position			

Remark for 4-pole contactors fitted with 2 N.O. + 2 N.C. main poles

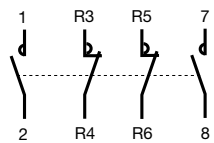

These contactors are suitable for controlling 2 separate circuits, i.e. 2 loads with 2 separate supplies, or 1 circuit comprising 2 separate loads with a single supply (see diagrams below). When the contactor operates there is no mechanical overlapping between the N.O. poles and the N.C. poles: BREAK before MAKE.



These contactors are not suitable for a reversing starter or for controlling a single load from 2 separate supplies.

Block diagrams

– Single supply and 2 separate loads

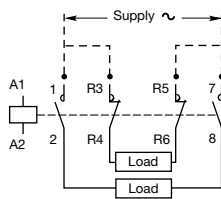



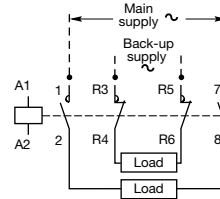







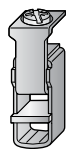



– 2 separate supplies and 2 separate loads



AF09 ... AF38 4-pole contactors

Technical data

Connecting characteristics

Contactor types	AF09	AF16	AF26	AF38
Main terminals				
	Screw terminals with cable clamp		Screw terminals with double connector 2 x (5.5 width x 6.8 depth)	
Connection capacity (min. ... max.)				
Main conductors (poles)				
 Rigid	Solid ($\leq 4 \text{ mm}^2$)	} 1 x	1...6 mm ²	1.5...16 mm ²
 Stranded ($\geq 6 \text{ mm}^2$)			2 x	1...6 mm ²
 Flexible with non insulated ferrule		1 x	0.75...6 mm ²	1.5...16 mm ²
 Flexible with non insulated ferrule		2 x	0.75...6 mm ²	1.5...16 mm ²
 Flexible with insulated ferrule		1 x	0.75...4 mm ²	1.5...16 mm ²
 Flexible with insulated ferrule		2 x	0.75...2.5 mm ²	1.5...16 mm ²
 Bars or lugs		L <	9.6 mm	-
Connection capacity acc. to UL/CSA	1 or 2 x		AWG 16...10	AWG 16...6
Stripping length			10 mm	12 mm
Tightening torque			1.5 Nm / 13 lb.in	2.5 Nm / 22 lb.in
Auxiliary conductors (coil terminals)				
 Rigid solid		1 x	1...2.5 mm ²	
 Rigid solid		2 x	1...2.5 mm ²	
 Flexible with non insulated ferrule		1 x	0.75...2.5 mm ²	
 Flexible with non insulated ferrule		2 x	0.75...2.5 mm ²	
 Flexible with insulated ferrule		1 x	0.75...2.5 mm ²	
 Flexible with insulated ferrule		2 x	0.75...1.5 mm ²	
 Lugs		L <	8 mm	
Connection capacity acc. to UL/CSA	1 or 2 x		AWG 18...14	
Stripping length			10 mm	
Tightening torque			1.2 Nm / 11 lb.in	
Degree of protection				
acc. to IEC 60947-1 / EN 60947-1 and IEC 60529 / EN 60529				
Main terminals	IP20			
Coil terminals	IP20			
Screw terminals	Delivered in open position, screws of unused terminals must be tightened			
Main terminals			M3.5	M4.5
	Screwdriver type	Flat Ø 5.5 / Pozidriv 2		
Coil terminals			M3.5	
	Screwdriver type	Flat Ø 5.5 / Pozidriv 2		

X-ON Electronics

Largest Supplier of Electrical and Electronic Components

Click to view similar products for [abb](#) manufacturer:

Other Similar products are found below :

[TV10-516R](#) [017667013](#) [RF727](#) [2CMA100178R1000](#) [5SDD 92Z0401](#) [ESV14-BS](#) [EZS-21-250](#) [F204AC-40/0.03](#) [F204AC-40/0.1](#) [F362-25/0.03](#) [GJL1211001R0011](#) [GJL1211201R8000](#) [GJL1211501R8000](#) [GJL1213001R0017](#) [GJL1213001R0101](#) [GJL1311001R0101](#) [GJL1311001R8010](#) [GJL1311201R0001](#) [GJL1313001R0011](#) [GJL1313001R0101](#) [GJL1317201R0001](#) [AF09-30-01-11](#) [AF460-30-11-68](#) [1455](#) [EF45-30](#) [ERG297](#) [HSC2-20](#) [1SAM201904R1001](#) [1SAM350000R1003](#) [1SAZ721201R1009](#) [1SAZ721201R1014](#) [1SAZ721201R1025](#) [1SFA611101R1002](#) [1SFA611130R1103](#) [1SFA611131R1101](#) [1SFA611143R1101](#) [1SFA611202R1108](#) [1SFA611203R1108](#) [1SFA611215R1001](#) [1SFA611216R1108](#) [1SFA611285R1002](#) [1SFA611702R6006](#) [1SFA616162R1025](#) [1SFA619100R3015](#) [1SVR730020R0200](#) [IPC4111](#) [OS30FACC12](#) [OS60GJ03](#) [OVR1N160277PS](#) [OXC1L48](#)