

IFX20002

Low Dropout Voltage Regulator

IFX20002MBV33
IFX20002MBV50

Data Sheet

Rev. 1.0, 2013-01-12

Standard Power



1 Overview

Features

- Two versions: 3.3 V, 5.0 V
- Low drop voltage ≤ 300 mV over the full temperature range
- Output current: 30 mA
- Inhibit input
- Low quiescent current
- Stable with ceramic output capacitor
- Input voltage up to 45 V
- Wide temperature range: $T_j = -40$ °C to $+125$ °C
- Output protected against short circuit
- Over temperature protection
- Reverse polarity protection
- Very small and thermally enhanced SMD-Package PG-SCT595-5
- Green Product (RoHS compliant)

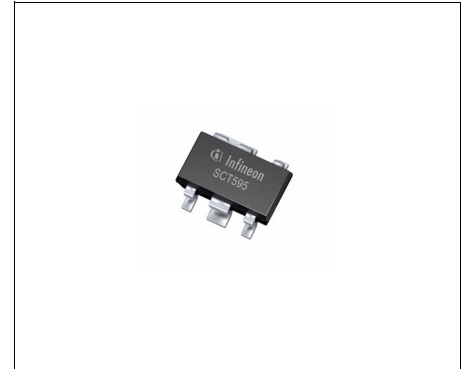

PG-SCT595-5

Applications

- Manufacturing Automation
- Appliances
- Network Routers

The **IFX20002** is not qualified and manufactured according to the requirements of Infineon Technologies with regards to automotive and/or transportation applications. For automotive applications please refer to the Infineon TLx (TLE, TLS, TLF.....) voltage regulator products.

Description

The **IFX20002** is a monolithic integrated low drop voltage regulator in a very small SMD package PG-SCT595-5. It is designed to supply e.g. micro controller, sensors, etc or may serve as standby supply under severe conditions. Therefore the device is equipped with additional protection functions against overload, short circuit and reverse polarity. At over temperature the regulator is automatically turned off by the integrated thermal protection circuit. Input voltages up to 40 V are regulated to $V_{Q,nom} = 3.3$ V (V33 version) or 5.0 V (V50 version). The output is able to drive a load of 30 mA while it regulates the output voltage within a 4% accuracy. To save energy the device can be switched in stand-by mode via an inhibit input which causes the current consumption to drop below 5 μ A.

Type	Package	Marking
IFX20002MBV33	PG-SCT595-5	E3
IFX20002MBV50	PG-SCT595-5	E5

2 Block Diagram

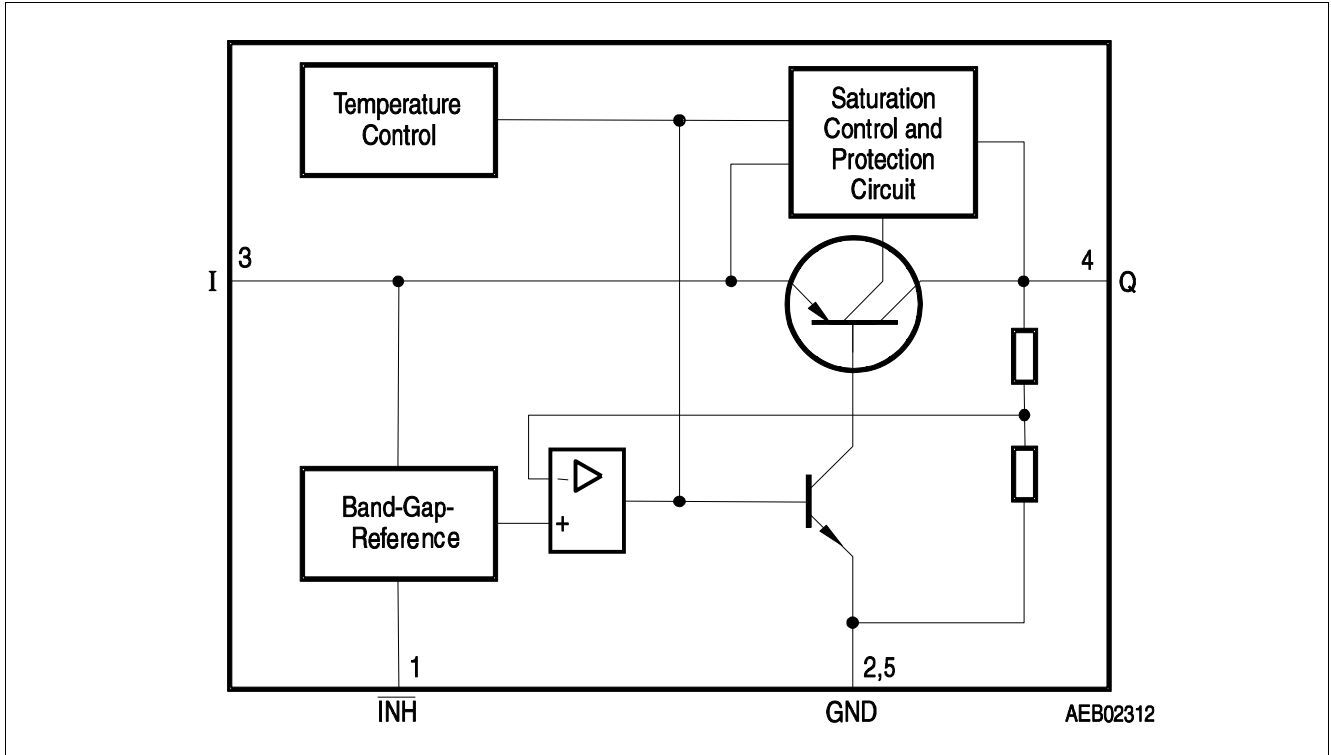

Figure 1 Block Diagram

3 Pin Configuration

3.1 Pin Assignment

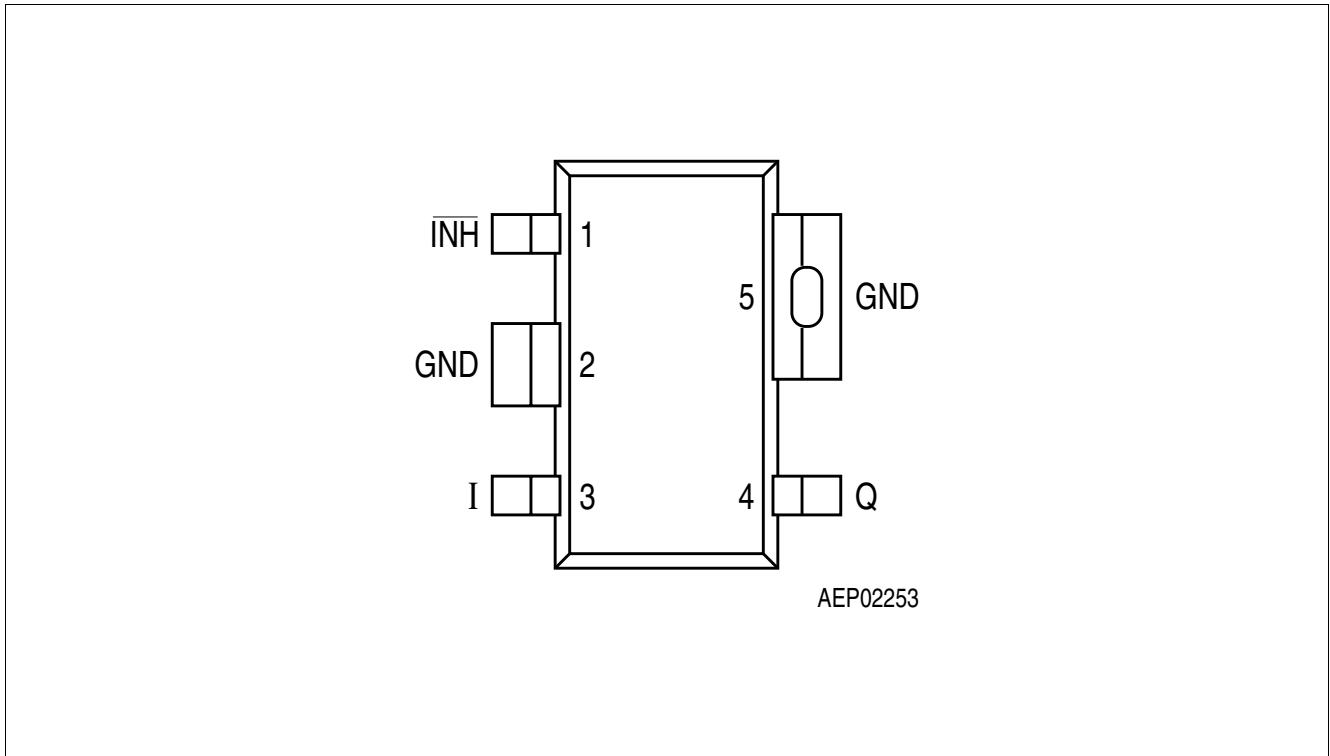

Figure 2 Pin Configuration (top view)

3.2 Pin Definitions and Functions

Pin	Symbol	Function
1	$\overline{\text{INH}}$	Inhibit Input: high level to turn on the IC
2	GND	Ground: connected to pin 5
3	I	Input Voltage
4	Q	Output voltage: must be blocked with a ceramic capacitor $C_Q \geq 3.3 \mu\text{F}$, $\text{ESR} \leq 2 \Omega$
5	GND	Ground: Connected to pin 2

4 General Product Characteristics

4.1 Absolute Maximum Ratings

Absolute Maximum Ratings ¹⁾

$T_j = -40\text{ °C}$ to $+125\text{ °C}$; all voltages with respect to ground, positive current flowing into pin (unless otherwise specified)

Pos.	Parameter	Symbol	Limit Values		Unit	Conditions
			Min.	Max.		
Input						
4.1.1	Voltage	V_I	-42	45	V	–
Output						
4.1.2	Voltage	V_Q	-0.3	30	V	–
Inhibit						
4.1.3	Voltage	$V_{\overline{\text{INH}}}$	-42	45	V	–
4.1.4	Current	$I_{\overline{\text{INH}}}$	-500	²⁾	μA	–
4.1.5	Current	$I_{\overline{\text{INH}}}$	-5	5	mA	$-0.3\text{ V} \leq V_I \leq 45\text{ V}$; $t_p < 1\text{ ms}$
Temperatures						
4.1.6	Junction Temperature	T_j	-40	150	°C	–
4.1.7	Storage Temperature	T_{stg}	-50	150	°C	–
ESD Susceptibility						
4.1.8	ESD Resistivity to GND	V_{ESD}	-2	2	kV	HBM ³⁾

1) Not subject to production test, specified by design.

2) Internally limited.

3) ESD susceptibility, HBM according to ANSI/ESDA/JEDEC JS-001 (1.5 kΩ, 100 pF).

Note: Stresses above the ones listed here may cause permanent damage to the device. Exposure to absolute maximum rating conditions for extended periods may affect device reliability.

Note: Integrated protection functions are designed to prevent IC destruction under fault conditions described in the data sheet. Fault conditions are considered as “outside” normal operating range. Protection functions are not designed for continuous repetitive operation.

4.2 Functional Range

Functional Range

Pos.	Parameter	Symbol	Limit Values		Unit	Conditions
			Min.	Max.		
4.2.1	Input Voltage	V_I	4.0	45	V	IFX20002MBV33
4.2.2			5.5	45	V	IFX20002MBV50
4.2.3	Inhibit Voltage	$V_{\overline{\text{INH}}}$	-0.3	40	V	–
4.2.4	Junction Temperature	T_j	-40	125	°C	–

Note: Within the functional or operating range, the IC operates as described in the circuit description. The electrical characteristics are specified within the conditions given in the Electrical Characteristics table.

4.3 Thermal Resistance

Note: This thermal data was generated in accordance with JEDEC JESD51 standards. For more information, go to www.jedec.org.

Pos.	Parameter	Symbol	Limit Values			Unit	Conditions
			Min.	Typ.	Max.		
4.3.5	Junction to Ambient	R_{thJA}	–	81	–	K/W	2s2p board ¹⁾
4.3.1			–	217	–	K/W	Footprint only ²⁾
4.3.2			–	117	–	K/W	300 mm ² PCB heatsink area ²⁾
4.3.3			–	103	–	K/W	600 mm ² PCB heatsink area ²⁾
4.3.4	Junction to Soldering Point	R_{thJSP}	–	30	–	K/W	Pins 2, 5 fixed to T_A

- 1) Specified R_{thJA} value is according to JESD51-2,-5,-7 at natural convection on FR4 2s2p board; The product (chip+package) was simulated on a 76.2 x 114.3 x 1.5 mm board with 2 inner copper layers (2 x 70µm Cu, 2 x 35µm Cu). Where applicable a thermal via array under the package contacted the first inner copper layer.
- 2) Package mounted on PCB FR4; 80 x 80 x 1.5 mm; 35 µm Cu, 5 µm Sn; horizontal position; zero airflow. Not subject to production test; specified by design.

5 Electrical Characteristics

5.1 Electrical Characteristics Voltage Regulator

Electrical Characteristics

$V_I = 13.5\text{ V}$; $V_{\overline{\text{INH}}} > 2.5\text{ V}$; $T_j = -40\text{ }^\circ\text{C}$ to $+125\text{ }^\circ\text{C}$; all voltages with respect to ground (unless otherwise specified)

Pos.	Parameter	Symbol	Limit Values			Unit	Measuring Condition
			Min.	Typ.	Max.		
5.1.1	Output Voltage	V_Q	3.17	3.3	3.43	V	$1\text{ mA} \leq I_Q \leq 30\text{ mA}$
5.1.2	IFX20002MBV33		3.17	3.3	3.43	V	$I_Q = 10\text{ mA}$; $4.3\text{ V} \leq V_I \leq 40\text{ V}$
5.1.1	Output Voltage	V_Q	4.80	5.00	5.20	V	$1\text{ mA} \leq I_Q \leq 30\text{ mA}$
5.1.2	IFX20002MBV50		4.80	5.00	5.20	V	$I_Q = 10\text{ mA}$; $6\text{ V} \leq V_I \leq 40\text{ V}$
5.1.3	Output Current Limitation	I_Q	30	–	–	mA	¹⁾
5.1.4	Dropout Voltage ¹⁾	V_{dr}	–	250	300	mV	$I_Q = 20\text{ mA}$
5.1.5	Output capacitor	C_Q	3.3	–	–	μF	$\text{ESR} \leq 2\ \Omega$ at 10 kHz
5.1.6	Current Consumption	I_q	–	2	5.2	mA	$I_Q < 30\text{ mA}$
5.1.7	$I_q = I_I - I_Q$		–	130	170	μA	$I_Q < 0.1\text{ mA}$; $T_j < 85\text{ }^\circ\text{C}$
5.1.8	Quiescent Current (stand-by)	I_q	–	–	1	μA	$V_{\overline{\text{INH}}} = 0.4\text{ V}$; $T_j < 85\text{ }^\circ\text{C}$
5.1.9	$I_q = I_I - I_Q$		–	–	5	μA	$V_{\overline{\text{INH}}} = 0.4\text{ V}$
5.1.10	Load Regulation	ΔV_Q	–	17	50	mV	$1\text{ mA} < I_Q < 25\text{ mA}$; $T_j = 25\text{ }^\circ\text{C}$; IFX20002MBV50
5.1.11			–	14	40	mV	$1\text{ mA} < I_Q < 25\text{ mA}$; $T_j = 25\text{ }^\circ\text{C}$; IFX20002MBV33
5.1.12	Line Regulation	ΔV_Q	–	10	25	mV	$V_I = (V_{Q,\text{nom}} + 0.5\text{ V})$ to 36 V ; $I_Q = 1\text{ mA}$; $T_j = 25\text{ }^\circ\text{C}$
5.1.13	Power Supply Ripple Rejection	PSRR	–	60	–	dB	$f_r = 100\text{ kHz}$; $V_r = 0.5\text{ Vpp}$

Logic Inhibit Input

5.1.14	Inhibit, Turn-on voltage	$V_{\overline{\text{INH}},\text{high}}$	–	–	2.2	V	$V_Q > 0.95 \cdot V_{Q,\text{nom}}$
5.1.15	Inhibit, Turn-off voltage	$V_{\overline{\text{INH}},\text{low}}$	0.4	–	–	V	$V_Q < 0.1\text{ V}$
5.1.16	H-input current	$I_{\overline{\text{INH}},\text{high}}$	–	8	12	μA	$V_{\overline{\text{INH}}} = 5\text{ V}$
5.1.17	L-input current	$I_{\overline{\text{INH}},\text{low}}$	-2	–	2	μA	$V_{\overline{\text{INH}}} = 0\text{ V}$

1) Measured when the output voltage V_Q has dropped 100 mV from the nominal value.

5.2 Typical Performance Characteristics Voltage Regulator

Output Voltage V_Q vs.
Input Voltage V_I

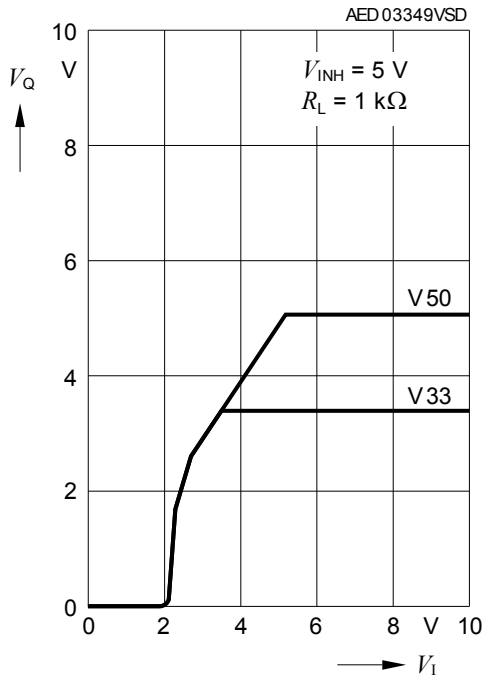

Current Consumption I_q vs.
Input Voltage V_I

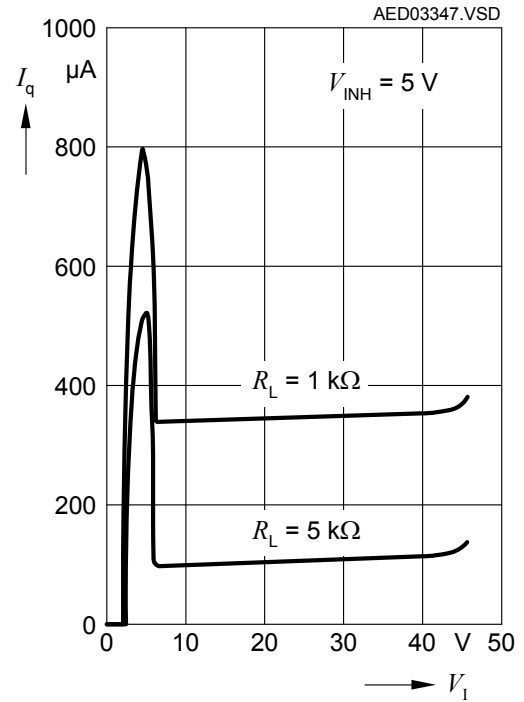

6 Application Information

Note: The following information is given as a hint for the implementation of the device only and shall not be regarded as a description or warranty of a certain functionality, condition or quality of the device.

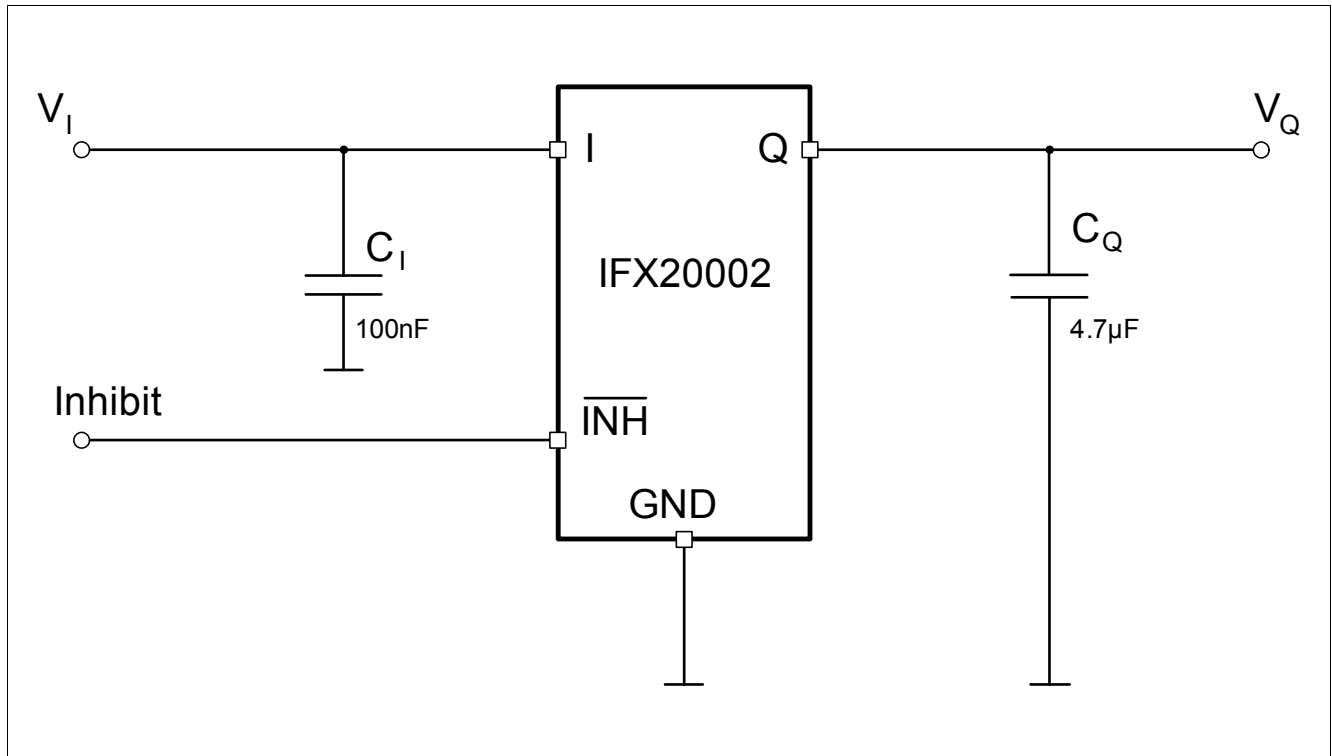

Figure 3 Application Diagram

The output voltage of the IFX20002 is divided and compared to an internal reference of 2.5 V typical. A regulation loop controls the output to achieve a stabilized output voltage.

Figure 3 shows a typical application circuit. In order to maintain the stability of the control loop the IFX20002 output requires an output capacitor C_Q of at least 3.3 μF with a maximum permissible ESR of 2 Ω . It is recommended to use a multi layer ceramic capacitor for C_Q , e.g. the TDK C3216X7R1C475M with a nominal capacitance of 4.7 μF . Aluminum electrolytic as well as tantalum capacitors do not cover the required ESR range over the full operating temperature range of $T_j = -40\text{ }^\circ\text{C}$ to $+125\text{ }^\circ\text{C}$.

At the input of the regulator an input capacitor is necessary for compensating line influences (100 nF ceramic capacitor recommended). A resistor of approx. 1 Ω in series with C_I can dampen oscillations that could occur due to the input inductivity and the input capacitor. If the regulator is sourced via long input lines of several meters it is recommended to place an additional electrolytic capacitor $\geq 47\text{ } \mu\text{F}$ at the input.

7 Package Outlines

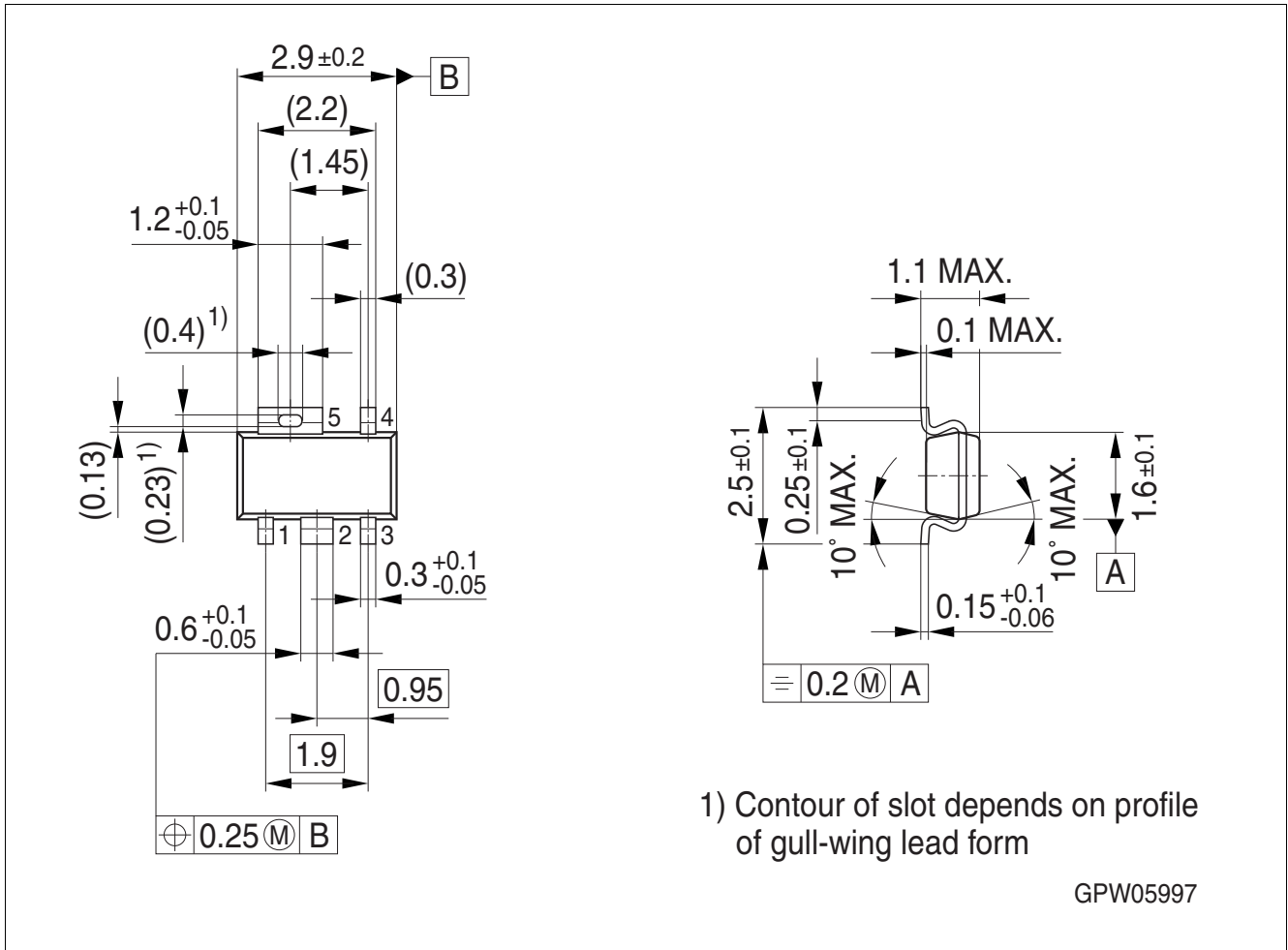

Figure 4 PG-SCT595-5 (Plastic Small Outline)

Green Product (RoHS compliant)

To meet the world-wide customer requirements for environmentally friendly products and to be compliant with government regulations the device is available as a green product. Green products are RoHS-Compliant (i.e Pb-free finish on leads and suitable for Pb-free soldering according to IPC/JEDEC J-STD-020).

For further information on alternative packages, please visit our website:

<http://www.infineon.com/packages>.

Dimensions in mm

8 Revision History

Revision	Date	Changes
Rev. 1.0	2013-01-12	Data Sheet – Initial Release

Edition 2013-01-12

**Published by
Infineon Technologies AG
81726 Munich, Germany**

**© 2013 Infineon Technologies AG
All Rights Reserved.**

Legal Disclaimer

The information given in this document shall in no event be regarded as a guarantee of conditions or characteristics. With respect to any examples or hints given herein, any typical values stated herein and/or any information regarding the application of the device, Infineon Technologies hereby disclaims any and all warranties and liabilities of any kind, including without limitation, warranties of non-infringement of intellectual property rights of any third party.

Information

For further information on technology, delivery terms and conditions and prices, please contact the nearest Infineon Technologies Office (www.infineon.com).

Warnings

Due to technical requirements, components may contain dangerous substances. For information on the types in question, please contact the nearest Infineon Technologies Office.

The Infineon Technologies component described in this Data Sheet may be used in life-support devices or systems and/or automotive, aviation and aerospace applications or systems only with the express written approval of Infineon Technologies, if a failure of such components can reasonably be expected to cause the failure of that life-support automotive, aviation and aerospace device or system or to affect the safety or effectiveness of that device or system. Life support devices or systems are intended to be implanted in the human body or to support and/or maintain and sustain and/or protect human life. If they fail, it is reasonable to assume that the health of the user or other persons may be endangered.

X-ON Electronics

Largest Supplier of Electrical and Electronic Components

Click to view similar products for [Switching Voltage Regulators](#) category:

Click to view products by [Infineon](#) manufacturer:

Other Similar products are found below :

[TLF30682QVS01XUMA1](#) [TPSM84209RKHR](#) [FAN53526UC106X](#) [FAN53526UC128X](#) [MP1587EN-LF](#) [FAN48610BUC33X](#)
[FAN48617UC50X](#) [FAN53526UC89X](#) [MIC45116-1YMP-T1](#) [NCV891234MW50R2G](#) [AST1S31PUR](#) [16017](#) [A6986FTR](#) [NCP81103MNTXG](#)
[NCP81203PMNTXG](#) [MAX17242ETPA+](#) [MAX16935RATEB/V+](#) [MP2313GJ-Z](#) [NCP81208MNTXG](#) [MP8759GD-Z](#) [FAN53526UC100X](#)
[FAN53526UC84X](#) [PCA9412AUKZ](#) [MP2314SGJ-Z](#) [AS1340A-BTDM-10](#) [MP3421GG-P](#) [NCP81109GMNTXG](#) [MP6003DN-LF-Z](#)
[MAX16935BAUES/V+](#) [LT8315IFE#PBF](#) [SCY1751FCCT1G](#) [NCP81109JMNTXG](#) [MAX16956AUBA/V+](#) [AP3409ADNTR-G1](#)
[FAN48623UC36FX](#) [MPQ2454GH](#) [MPQ2454GH-AEC1](#) [MP21148GQD-P](#) [AS3701B-BWLM-68](#) [MPQ2143DJ-P](#) [MP9942AGJ-P](#)
[MP8759GD-P](#) [MP5610GQG-P](#) [MP28200GG-P](#) [MP2451DJ-LF-Z](#) [MP2326GD-P](#) [MP2314SGJ-P](#) [MP2158AGQH-P](#) [MP2148GQD-18-P](#)
[MP1470HGJ-P](#)