

Amphenol®



ePower Connectors

www.amphenol-industrial.com

Amphenol® ePower Connectors are UL Recognized

Company Overview

Manufacturing connectors for over eight decades, we take pride that Amphenol Industrial Operations (AIO) is the undisputed leader in interconnect systems for harsh environment applications. Such applications require a high degree of engineering sophistication and precision manufacturing capability. Innovations like our RADSOK® contact technology can provide up to 50% more current through the same size pin. Connectors utilizing this RADSOK® technology will outperform similar products in the market hands down.

Amphenol Industrial, a division of the Amphenol Corporation, is a leading global manufacturer of cylindrical connectors. Amphenol Industrial's product lines consist of rectangular, standard miniature, fiber optic, EMI/EMP filter, and a variety of special application connectors.

Our manufacturing capabilities include state-of-the-art CNC machining, die-casting, molding, impact and extruding, plating, screw machining and process controls.

AIO also has a fully equipped material evaluation lab and an engineering support organization utilizing the latest in computer aided design software and analysis tools.

Our global manufacturing facilities include locations in Sidney, NY, Fraser, MI, Midland, TX, Shenzhen and Zhuhai, China, Winnipeg, Canada, and Nogales, Mexico.

The ePower Connector Series

This series of connectors is designed for the demanding requirements of hybrid, electric vehicles, and utility truck electrical systems, operating at 800VDC to 1000VDC with 200A, 400A, and 700A continuous current ratings. The product incorporates the patented RADSOK® technology for higher amperage, lower T-rise, less resistance and mating force. Meantime, it offers a 40% smaller footprint than three EMI shielding cable glands and easier operation of termination with shielded cable by a washer compressing the shield to the inside surface of the shell. The connector series covers 2 or 3 power contacts. As an example, one ePower 400A connector can replace three conventional connectors, saving space and cost.

The markets and application for the ePower Series include but are not limited to the following found in both the Military Aerospace and Industrial segments:

- Power converters
- Hybrid electric vehicles
- Heavy equipment electrification
- Two and three phase motors
- Starter generators

RADSOK® Technology Advantages

RADSOK'S twisted grid configuration allows for 50% more current to pass through the same size pin, while providing increased reliability, ampacity and cycle durability as well as lower insertion force, T-rise and voltage drop.

• HIGH RELIABILITY

Unique RADSOK® design and construction technology create an electrical contact interface that exceeds typical interconnect requirements. Applications in aerospace, medical, industrial, automotive, mining, offshore, and other harsh environments depend on the high reliability of Amphenol's RADSOK® technology.

• LOW CONTACT ENGAGEMENT/SEPARATION FORCES

The hyperbolic lamella socket contact construction distributes normal forces over a high percentage of the mating pin surface. This creates a smooth, even engagement effort. This force distribution also contributes to excellent performance in vibration applications with resistance to typical fretting corrosion.

• LOW CONTACT RESISTANCE

The large interface area between the socket lamella and pin surface result in very low contact resistance, enabling the RADSOK® contacts' high current ratings compared to traditional power contact designs.

• HIGH MATING CYCLE DURABILITY

RADSOK® contacts with typical silver plating finishes have demonstrated survival of 20,000 mating cycles. Specialized plating and contact lubricants can extend cycle life to 200,000 matings or higher. Even with continuous exposure to harsh environmental abuse (salt, sand, and high humidity), RADSOK® contacts have been tested to maintain low contact resistance beyond 10,000 mating cycles.

RADSOK® Derating Chart – Temperature vs. Current

Based on single conductors in free air. Wire cross-section same size as pin contact cross-sectional area.

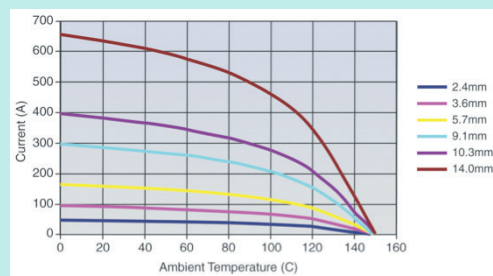

ePower Features

- Two or three circuit power
- Crimp, lug or bus bar termination
- IP2X on pin and socket
- Environmental IP67 rating
- Two HVIL circuits
- 1,000VDC rating
- Integrated EMI shielding
- 8.0mm, 11.1mm, & 18mm RADSOK® technology for 200, 400, & 700A continuous current capability
- Strain relief for jacketed cable incorporated into shell
- Excellent vibration resistance
- All aluminum shell
- RoHS Compliant



200 A 2 Way Receptacle and Plug

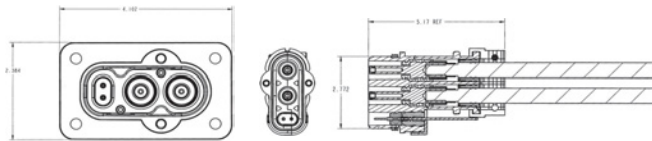

200 A 3 Way Receptacle and Plug

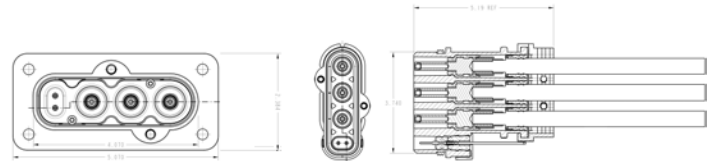

400 A 2 Way Receptacle and Plug

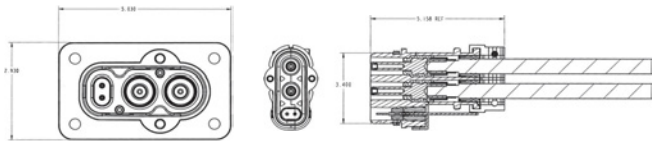

400 A 3 Way Receptacle and Plug

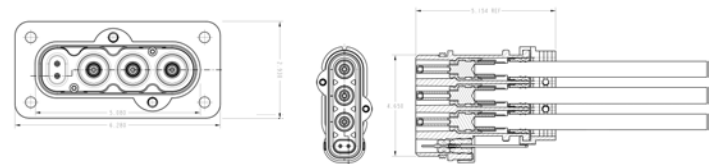

700 A 2 Way Receptacle and Plug

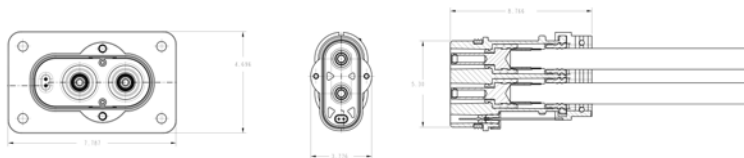

HOW TO ORDER

HOW TO ORDER															
1	2		3		4		5		6		7		8		
e	P		2		2		25		1		1		UL		
Product Line	Connector		Amp Level		Number of Poles		Wire Size		Key Position		Plating		Approval		
e	ePower	P	Plug	2	200A	2	2 Pole	BB	Busbar (Receptacle Only)	1	Available in 2 & 3 Pole	1	Electroless Nickel	UL	Sizes 1A and 40 Only
		R	Receptacle	4	400A	3	3 Pole	25	25mm ² (200A Only)	2	Available in 2 & 3 Pole	FL	Gray Zinc Nickel (500 hours)		
				7	700A			35	35mm ² (200A Only)	3	Available in 2 & 3 Pole				
								50	50mm ² (200A or 400A)	4	Available in 2 & 3 Pole				
								1A	1 AWG (200A or 400A)	5	Available in 3 Pole Only				
								70	70mm ² (400A Only)	6	Available in 3 Pole Only				
								95	95mm ² (400A Only)	7	Available in 3 Pole Only				
								40	4/0 (400A Only)	8	Available in 3 Pole Only				
								24	240mm ² (700A Only)						
								30	300mm ² (700A Only)						

ePower Accessories and Replacement Parts

Receptacle Cap



Plug Cap

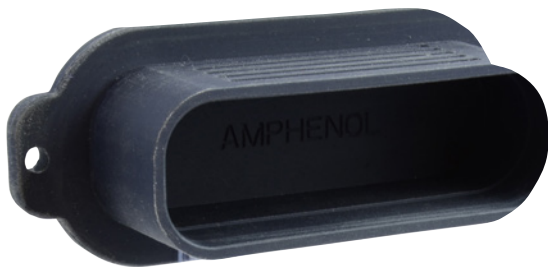

Cavity Plugs



CODED PN	DESCRIPTION
CVR-43R	Cover for 3way 400A Receptacle
CVR-43P	Cover for 3way 400A Plug
CVR-23R	Cover for 3way 200A Receptacle
CVR-23P	Cover for 3way 200A Plug
CVR-42R	Cover for 2way 400A Receptacle
CVR-42P	Cover for 2way 400A Plug
CVR-22R	Cover for 2way 200A Receptacle
CVP-400	Cavity Plug for 400A
CVP-200	Cavity Plug for 200A
HVIL-P-KIT	HVIL Plug side kit (signal grommet cover 10-643757-000, signal grommet 10-643754-000, signal contacts 10-040557-000, signal insert 10-643738-000)
HVIL-R-SOC	HVIL Receptacle side socket terminals
PIN-11-50	11.1mm pin contact asm 50mm2
PIN-11-70	11.1mm pin contact asm 70mm2
PIN-11-95	11.1mm pin contact asm 95mm2
CBL-GROM-11-50	11.1mm power cable grommet 50mm2
CBL-GROM-11-70	11.1mm power cable grommet 70mm2
CBL-GROM-11-95	11.1mm power cable grommet 95mm2
CBL-CLMP-50-42	Cable clamp 50mm2, 2WAY 400 AMP
CBL-CLMP-70-42	Cable clamp 70mm2, 2WAY 400 AMP
CBL-CLMP-95-42	Cable clamp 95mm2, 2WAY 400 AMP
CBL-CLMP-50-43	Cable clamp 50mm2, 3WAY 400 AMP
CBL-CLMP-70-43	Cable clamp 70mm2, 3WAY 400 AMP
CBL-CLMP-95-43	Cable clamp 95mm2, 3WAY 400 AMP
CBL-CLMP-25-22	Cable clamp 25mm2, 2WAY 200 AMP
CBL-CLMP-35-22	Cable clamp 35mm2, 2WAY 200 AMP
CBL-CLMP-50-22	Cable clamp 50mm2, 2WAY 200 AMP
CBL-CLMP-25-23	Cable clamp 25mm2, 3WAY 200 AMP
CBL-CLMP-35-23	Cable clamp 35mm2, 3WAY 200 AMP
CBL-CLMP-50-23	Cable clamp 50mm2, 3WAY 200 AMP
PIN-08-25	8.0mm pin contact asm 25mm2
PIN-08-35	8.0mm pin contact asm 35mm2
PIN-08-50	8.0mm pin contact asm 50mm2
CBL-GROM-08-25	8.0mm power cable grommet 25mm2
CBL-GROM-08-35	8.0mm power cable grommet 35mm2
CBL-GROM-08-50	8.0mm power cable grommet 50mm2
PIN-INSL-11	11.1mm pin insulation
PIN-INSL-08	8.0mm pin insulation
FG-42R	Flange gasket 400amp 2way receptacle
FG-43R	Flange gasket 400amp 3way receptacle
FG-22R	Flange gasket 200amp 2way receptacle
FG-23R	Flange gasket 200amp 3way receptacle
RAD-11-BB	11.0mm RADSOK® contact assembly, BUSBAR
RAD-11-50	11.0mm RADSOK® contact assembly, 50MM2
RAD-11-75	11.0mm RADSOK® contact assembly, 75MM2
RAD-11-95	11.0mm RADSOK® contact assembly, 95MM2
RAD-08-BB	8.0mm RADSOK® contact assembly, BUSBAR
RAD-08-25	8.0mm RADSOK® contact assembly, 25MM2
RAD-08-35	8.0mm RADSOK® contact assembly, 35MM2
RAD-08-50	8.0mm RADSOK® contact assembly, 50MM2

ePower Alternate Designs and Cable Assemblies

Right Angle Over Molded: ships as a cable assembly.
For more information, inquire about PN ePRAXX11.

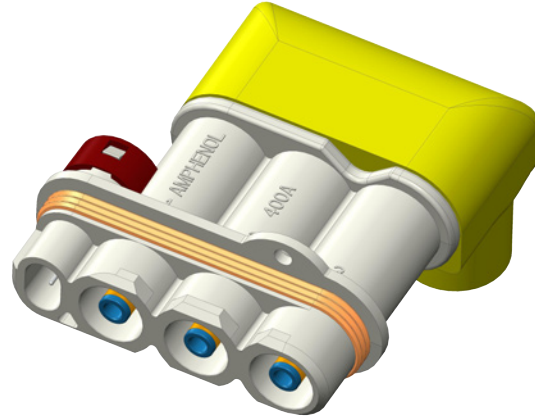
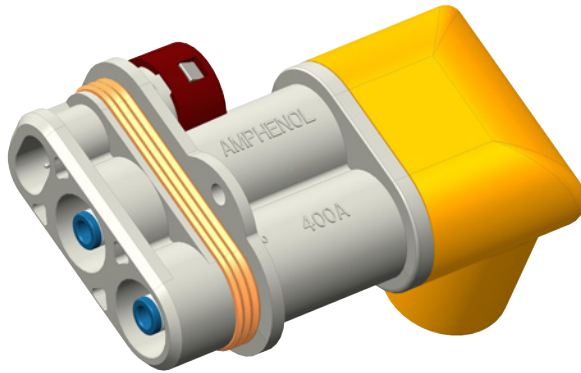

500 Amp

(3-pin design can also be done)

For more information, inquire about PN eP5XXX11.

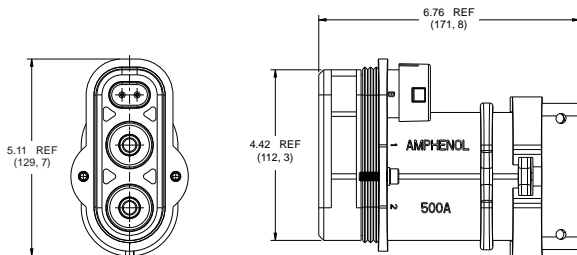

Sealed In-line Receptacle

(Available in 2 or 3 pole and 200A or 400A styles)

For more information, inquire about PN eSRXXX11.

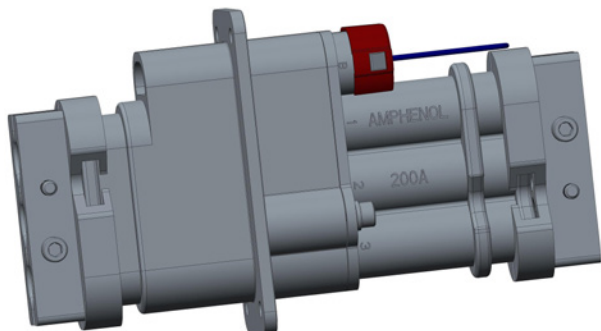

Cable assemblies:

Let Amphenol Industrial provide value added cable assemblies.

- We can design and build your ePower harnesses in Nogales Mexico or Zhuhai China.
- Ensures a quality harness with the people who know the components the best.
- Save on lead time and moving parts around with “one stop shopping”.
- We buy our own bulk cable, or we can purchase your required specification.
- We can add coverings, clips, and any components you need on the other end, or we can ship blunt cut leads.
- We can do any of your low voltage cable assemblies too.
- Let us show you that we are the lowest cost alternative and best value.

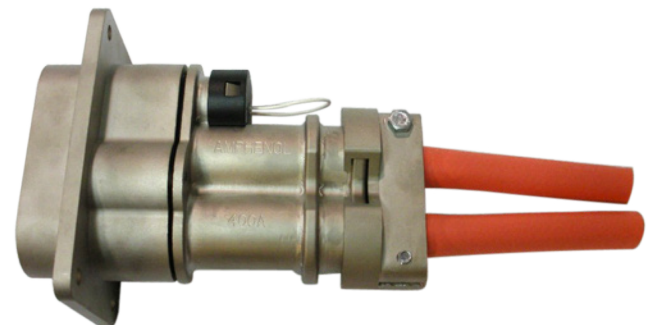



AMPHENOL CORPORATION
Amphenol Industrial

Phone: 607-563-5011
40-60 Delaware Avenue
Sidney, NY 13838-1395
www.amphenol-industrial.com

X-ON Electronics

Largest Supplier of Electrical and Electronic Components

Click to view similar products for [amphenol manufacturer](#):

Other Similar products are found below :

[CTV06RGQF-17-52P](#) [CTVPS00RGF-23-6P-LC](#) [GC835TY2S](#) [CF-509621-29P](#) [BF8-1218-31SV-Y70](#) [TVP00RGW-23-6SA\(LC\)](#)
[RNJ27CI1535P014](#) [10-553998-139](#) [21-033388-031](#) [10-507142-843](#) [GTS06G-32-7S](#) [GTC06-36-78PX-023](#) [ACC02E28-51S-003-B30-LC](#)
[TV06RL-13-35SD-LC](#) [TV06RL-13-35SD](#) [TV06RL-13-98SD-LC](#) [TV06RL-13-98SD](#) [GTC08AF32-15SX-B30-LC](#) [GTC06G32-76PZ](#)
[TVP00RW-23-53AD](#) [100-007-213-002-001](#) [5M30-61](#) [FSPP-103-00-004](#) [360031](#) [10-037090-161](#) [10-541504-001](#) [10-580902-409](#) [TV97RW-](#)
[9-9S\(S15\)](#) [TVPS00RGF-9-5P-LC](#) [TVPS00RGF-9-5PA-LC](#) [TVP00RGQW-21-75P-LC](#) [TV06RW-25-90AE](#) [97-3108B16S-5PW-417](#) [PT06J20-](#)
[24SW](#) [97-3108B16S-4PY-417](#) [97-3108B16S-4PX-417](#) [97-3108B16S-5PY-417](#) [97-3108B16S-4PW-417](#) [CS-DSDMDB37MF-025](#) [97-](#)
[3108B16S-5PZ-417](#) [TV06RW-25-46AE](#) [TVS07RF-21-16AA](#) [TVS07RF-21-39BA](#) [60261626SNCOND1](#) [SE00TVW09](#) [CF-5A9013-04N](#) [CF-](#)
[6A4615-06N](#) [GTS01-22-22PX-025-116](#) [GTS01-22-22P-025-116](#) [GTS01-22-22P-116](#)