

# 55 Raised design

## Illuminated pushbutton square 18 x 18 mm

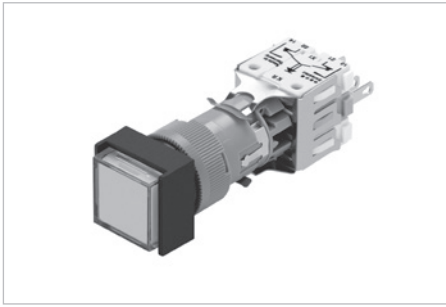

Product can differ from the current configuration.

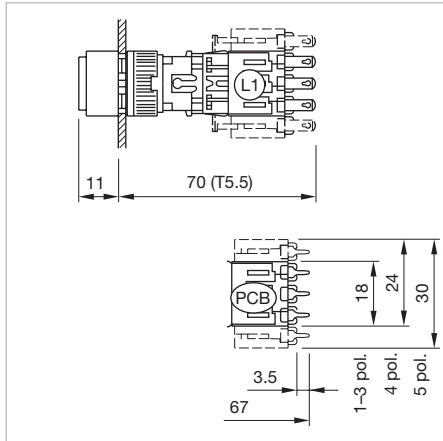

Dimensions [mm]  
L1 = Solder terminal 2.8 x 0.5 mm,  
PCB = Print terminal

### Equipment consisting of (schematic overview)

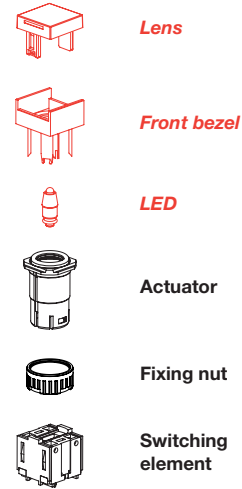

Each Part Number listed below includes all the black components shown in the 3D-drawing.

To obtain a complete unit, please select the red components from the pages shown.

### Additional Information

- For the flush design please order the additional front bezel set, see chapter «Accessories»
- Protection degree IP 40/IP 65 is determined by front bezel and lens
- Maintain to momentary action is switchable, reversible

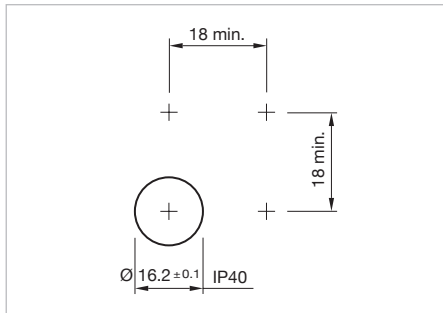

Mounting cut-outs [mm]

Switching system	Behind panel depth	Contacts	Switching action	Lamp socket	Terminal	Part No.	Wiring diagram	Weight
 <b>Illuminated pushbutton actuator square, Front dimension 18 x 18 mm</b>								
Snap-action switching element	70 mm	1 NC + 1 NO	C - B	T5.5	Solder 2.8 x 0.5 mm	<b>801F.000-00</b>	1	0.015 kg
		2 NC + 2 NO	C - B	T5.5	Solder 2.8 x 0.5 mm	<b>802F.000-00</b>	2	0.016 kg



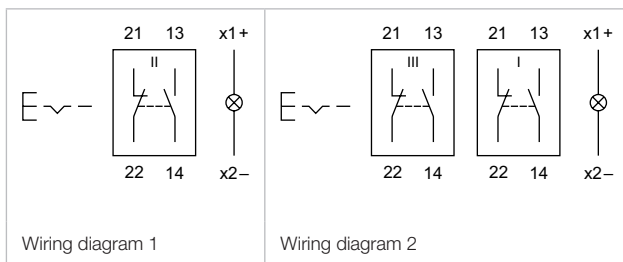

Contacts: NC = Normally closed, NO = Normally open  
Switching action: B = Momentary, C = Maintained



## Front bezel

### Additional Information

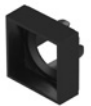
- Front bezel IP 65 is supplied with fitted sealing ring.

Product attribute	Front protection	Front bezel	Part No.	Weight
 <p><b>Front bezel square, 18 x 18 mm</b></p>	IP 40	Plastic grey	<b>200-3000-00</b>	0.002 kg
		Plastic black	<b>200-4000-00</b>	0.002 kg
 <p><b>Front bezel rectangular, 18 x 24 mm</b></p>	IP 40	Plastic grey	<b>200-5000-00</b>	0.002 kg
		Plastic black	<b>200-6000-00</b>	0.002 kg
 <p><b>Front bezel round, 18 mm</b></p>	IP 40	Plastic grey	<b>200-1000-00</b>	0.002 kg
		Plastic black	<b>200-2000-00</b>	0.002 kg
 <p><b>Front bezel square, 24 x 24 mm</b></p>	IP 40	Plastic grey	<b>200-9000-00</b>	0.002 kg
		Plastic black	<b>200-0000-00</b>	0.002 kg
	IP 65	Plastic grey	<b>200-9000-W0</b>	0.002 kg
		Plastic black	<b>200-0000-W0</b>	0.002 kg
 <p><b>Front bezel round, 24 mm</b></p>	IP 40	Plastic grey	<b>200-7000-00</b>	0.002 kg
		Plastic black	<b>200-8000-00</b>	0.002 kg
	IP 65	Plastic grey	<b>200-7000-W0</b>	0.002 kg
		Plastic black	<b>200-8000-W0</b>	0.002 kg

## X-ON Electronics

Largest Supplier of Electrical and Electronic Components

*Click to view similar products for [eao manufacturer](#):*

Other Similar products are found below :

[01-951.5](#) [21-931.0](#) [01-261.022](#) [02-072.001](#) [61-0029.0](#) [61-1300.0](#) [61-221.50D](#) [61-2601.0/D](#) [61-2701.0/D](#) [61-8640.11](#) [61-8720.17](#) [704.012.0](#)  
[704.062.218](#) [704.113.0](#) [704.117.0](#) [704.121.0](#) [704.411.018I](#) [704-6012](#) [704.901.1](#) [704.902.3](#) [704-9051](#) [704.950.0](#) [EUS-704.000.7](#) [82-](#)  
[4151.2144](#) [82-4153.1000](#) [84-8515.8640](#) [92-343.400](#) [95-900.005](#) [14-136.025K](#) [14-810.910](#) [200-4001-00](#) [22-212.011](#) [95-900.009](#) [22-225.011](#)  
[22-901.2](#) [31-426.036](#) [45-1231.21N6.000.101](#) [45-2134.4F10.000](#) [45-280X.1C90.003](#) [45-2C37.1920.000](#) [45-2T00.10E0.000](#) [51-401.036K](#) [51-](#)  
[901.4](#) [31-953.3](#) [31-955.4](#) [41-461.036](#) [41-908.5/5](#) [45-1131.3150.000.101](#) [45-2131.2150.000](#) [45-2231.31H0.000](#)