

# G3PE-Single-phase

**Compact, Slim-profile SSRs with Heat Sinks. Models with No Zero Cross for a Wide Range of Applications.**



- RoHS compliant.
- Models also available with no zero cross
- Surge pass protection improved surge dielectric strength for output currents. (OMRON testing)
- Compact with a slim profile.
- Mount to DIN Track or with screws.
- Conforms to UL, CSA, and EN standards (TÜV certification).



 Refer to *Safety Precautions for All G3PE Models.*

## Ordering Information

### List of Models

| Number of phases | Insulation method  | Operation indicator | Rated input voltage | Zero cross function | Applicable load *    | Model                     |
|------------------|--------------------|---------------------|---------------------|---------------------|----------------------|---------------------------|
| Single-phase     | Phototriac coupler | Yes (yellow)        | 12 to 24 VDC        | Yes                 | 15 A, 100 to 240 VAC | <b>G3PE-215B DC12-24</b>  |
|                  |                    |                     |                     |                     | 25 A, 100 to 240 VAC | <b>G3PE-225B DC12-24</b>  |
|                  |                    |                     |                     |                     | 35 A, 100 to 240 VAC | <b>G3PE-235B DC12-24</b>  |
|                  |                    |                     |                     |                     | 45 A, 100 to 240 VAC | <b>G3PE-245B DC12-24</b>  |
|                  |                    |                     |                     | No                  | 15 A, 100 to 240 VAC | <b>G3PE-215BL DC12-24</b> |
|                  |                    |                     |                     |                     | 25 A, 100 to 240 VAC | <b>G3PE-225BL DC12-24</b> |
|                  |                    |                     |                     |                     | 35 A, 100 to 240 VAC | <b>G3PE-235BL DC12-24</b> |
|                  |                    |                     |                     |                     | 45 A, 100 to 240 VAC | <b>G3PE-245BL DC12-24</b> |
|                  |                    |                     |                     | Yes                 | 15 A, 200 to 480 VAC | <b>G3PE-515B DC12-24</b>  |
|                  |                    |                     |                     |                     | 25 A, 200 to 480 VAC | <b>G3PE-525B DC12-24</b>  |
|                  |                    |                     |                     |                     | 35 A, 200 to 480 VAC | <b>G3PE-535B DC12-24</b>  |
|                  |                    |                     |                     |                     | 45 A, 200 to 480 VAC | <b>G3PE-545B DC12-24</b>  |
|                  |                    |                     |                     | No                  | 15 A, 200 to 480 VAC | <b>G3PE-515BL DC12-24</b> |
|                  |                    |                     |                     |                     | 25 A, 200 to 480 VAC | <b>G3PE-525BL DC12-24</b> |
|                  |                    |                     |                     |                     | 35 A, 200 to 480 VAC | <b>G3PE-535BL DC12-24</b> |
|                  |                    |                     |                     |                     | 45 A, 200 to 480 VAC | <b>G3PE-545BL DC12-24</b> |

\* The applicable load current depends on the ambient temperature. For details, refer to *Load Current vs. Ambient Temperature* in *Engineering Data* on page 3.

## Specifications

### Certification

UL508, CSA22.2 No.14, and EN60947-4-3

### Ratings

#### Input (at an Ambient Temperature of 25°C)

| Model      | Item | Rated voltage | Operating voltage range | Rated input current | Voltage level        |                      |
|------------|------|---------------|-------------------------|---------------------|----------------------|----------------------|
|            |      |               |                         |                     | Must operate voltage | Must release voltage |
| G3PE-□□□B  |      | 12 to 24 VDC  | 9.6 to 30 VDC           | 7 mA max.           | 9.6 VDC max.         | 1.0 VDC max.         |
| G3PE-□□□BL |      |               |                         | 15 mA max.          |                      |                      |

#### Output

| Item   | Model | G3PE-215B(L)                 | G3PE-225B(L)                 | G3PE-235B(L)              | G3PE-245B(L)             | G3PE-515B(L)                 | G3PE-525B(L)                 | G3PE-535B(L)              | G3PE-545B(L)             |
|--|-------|------------------------------|------------------------------|---------------------------|--------------------------|------------------------------|------------------------------|---------------------------|--------------------------|
| Rated load voltage                             |       | 100 to 240 VAC (50/60 Hz)    |                              |                           |                          | 200 to 480 VAC (50/60 Hz)    |                              |                           |                          |
| Load voltage range                             |       | 75 to 264 VAC (50/60 Hz)     |                              |                           |                          | 180 to 528 VAC (50/60 Hz)    |                              |                           |                          |
| Applicable load current *                      |       | 0.1 to 15 A<br>(at 40°C)     | 0.1 to 25 A<br>(at 40°C)     | 0.5 to 35 A<br>(at 25°C)  | 0.5 to 45 A<br>(at 25°C) | 0.1 to 15 A<br>(at 40°C)     | 0.1 to 25 A<br>(at 40°C)     | 0.5 to 35 A<br>(at 25°C)  | 0.5 to 45 A<br>(at 25°C) |
| Inrush current resistance                      |       | 150 A<br>(60 Hz,<br>1 cycle) | 220 A<br>(60 Hz,<br>1 cycle) | 440 A<br>(60 Hz, 1 cycle) |                          | 150 A<br>(60 Hz,<br>1 cycle) | 220 A<br>(60 Hz,<br>1 cycle) | 440 A<br>(60 Hz, 1 cycle) |                          |
| Permissible I <sup>2</sup> t (reference value) |       | 121A <sup>2</sup> s          | 260A <sup>2</sup> s          | 1,260A <sup>2</sup> s     |                          | 128A <sup>2</sup> s          | 1,350A <sup>2</sup> s        |                           | 6,600A <sup>2</sup> s    |
| Applicable load (resistive load)               |       | 3 kW<br>(at 200 VAC)         | 5 kW<br>(at 200 VAC)         | 7 kW<br>(at 200 VAC)      | 9 kW<br>(at 200 VAC)     | 6 kW<br>(at 400 VAC)         | 10 kW<br>(at 400 VAC)        | 14 kW<br>(at 400 VAC)     | 18 kW<br>(at 400 VAC)    |

\* The applicable load current depends on the ambient temperature. For details, refer to *Load Current vs. Ambient Temperature* in *Engineering Data* on page 3.

### Characteristics

| Item                          | Model | G3PE-215B  | G3PE-225B | G3PE-235B     | G3PE-245B | G3PE-215BL    | G3PE-225BL | G3PE-235BL    | G3PE-245BL |
|-------------------------------|-------|--|-----------|---------------|-----------|---------------|------------|---------------|------------|
| Operate time                  |       | 1/2 of load power source cycle + 1 ms max.   |           |               |           | 1 ms max.     |            |               |            |
| Release time                  |       | 1/2 of load power source cycle + 1 ms max.   |           |               |           |               |            |               |            |
| Output ON voltage drop        |       | 1.6 V (RMS) max.   |           |               |           |               |            |               |            |
| Leakage current               |       | 10 mA max. (at 200 VAC)  |           |               |           |               |            |               |            |
| Insulation resistance         |       | 100 MΩ min. (at 500 VDC)   |           |               |           |               |            |               |            |
| Dielectric strength           |       | 2,500 VAC, 50/60 Hz for 1 min  |           |               |           |               |            |               |            |
| Vibration resistance          |       | 10 to 55 to 10 Hz, 0.375-mm single amplitude (0.75-mm double amplitude) (Mounted to DIN track) |           |               |           |               |            |               |            |
| Shock resistance              |       | Destruction: 294 m/s <sup>2</sup> (Mounted to DIN track)                                       |           |               |           |               |            |               |            |
| Ambient storage temperature   |       | -30 to 100°C (with no icing or condensation)   |           |               |           |               |            |               |            |
| Ambient operating temperature |       | -30 to 80°C (with no icing or condensation)  |           |               |           |               |            |               |            |
| Ambient operating humidity    |       | 45% to 85%   |           |               |           |               |            |               |            |
| Weight                        |       | Approx. 240 g  |           | Approx. 400 g |           | Approx. 240 g |            | Approx. 400 g |            |

| Model | Item                          | G3PE-515B  | G3PE-525B | G3PE-535B     | G3PE-545B | G3PE-515BL    | G3PE-525BL | G3PE-535BL    | G3PE-545BL |
|-------|-------------------------------|--|-----------|---------------|-----------|---------------|------------|---------------|------------|
|       | Operate time                  | 1/2 of load power source cycle + 1 ms max.   |           |               |           | 1 ms max.     |            |               |            |
|       | Release time                  | 1/2 of load power source cycle + 1 ms max.   |           |               |           |               |            |               |            |
|       | Output ON voltage drop        | 1.8 V (RMS) max.   |           |               |           |               |            |               |            |
|       | Leakage current               | 20 mA max. (at 480 VAC)  |           |               |           |               |            |               |            |
|       | Insulation resistance         | 100 MΩ min. (at 500 VDC)   |           |               |           |               |            |               |            |
|       | Dielectric strength           | 2,500 VAC, 50/60 Hz for 1 min  |           |               |           |               |            |               |            |
|       | Vibration resistance          | 10 to 55 to 10 Hz, 0.375-mm single amplitude (0.75-mm double amplitude) (Mounted to DIN track) |           |               |           |               |            |               |            |
|       | Shock resistance              | Destruction: 294 m/s <sup>2</sup> (Mounted to DIN track)                                       |           |               |           |               |            |               |            |
|       | Ambient storage temperature   | -30 to 100°C (with no icing or condensation)   |           |               |           |               |            |               |            |
|       | Ambient operating temperature | -30 to 80°C (with no icing or condensation)  |           |               |           |               |            |               |            |
|       | Ambient operating humidity    | 45% to 85%   |           |               |           |               |            |               |            |
|       | Weight                        | Approx. 240 g  |           | Approx. 400 g |           | Approx. 240 g |            | Approx. 400 g |            |

# Engineering Data

## Input Voltage vs. Input Impedance and Input Voltage vs. Input Current

G3PE-2□□B

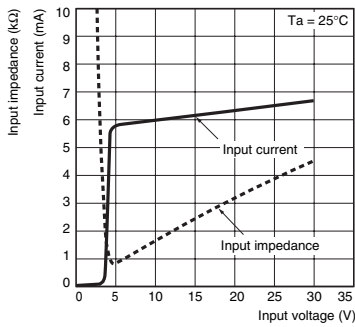

G3PE-2□□BL

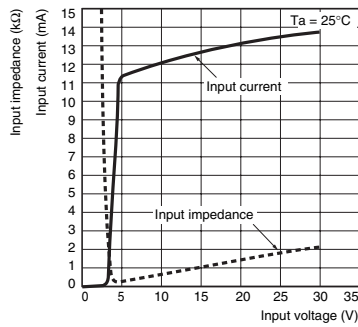

G3PE-5□□B

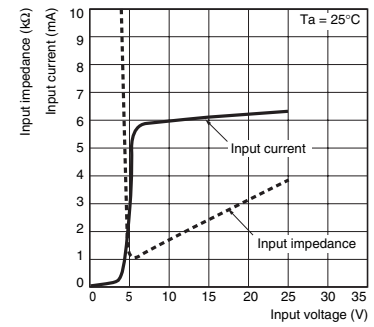

G3PE-5□□BL

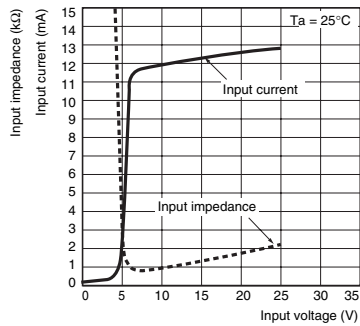

## Load Current vs. Ambient Temperature

G3PE-215B(L), G3PE-225B(L)  
G3PE-515B(L), G3PE-525B(L)

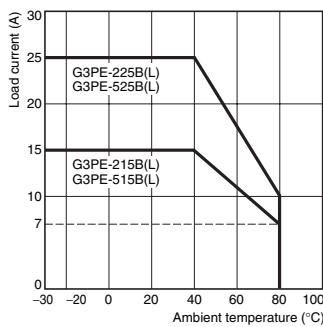

G3PE-235B(L), G3PE-245B(L)  
G3PE-535B(L), G3PE-545B(L)

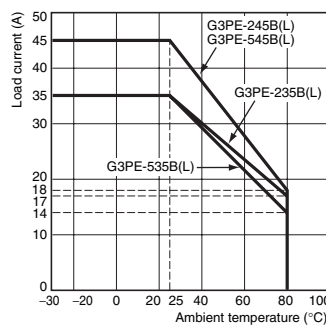

## Inrush Current Resistance: Non-repetitive

Keep the inrush current to below the inrush current resistance value (i.e., below the broken line) if it occurs repetitively.

G3PE-215B(L), G3PE-515B(L)

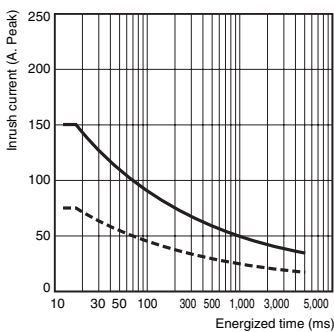

G3PE-225B(L), G3PE-525B(L)

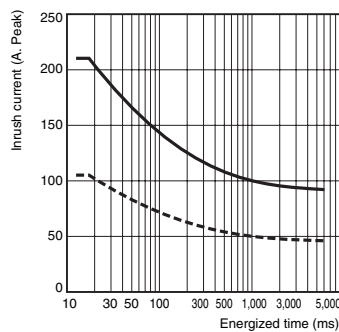

G3PE-235B(L), G3PE-245B(L)  
G3PE-535B(L), G3PE-545B(L)

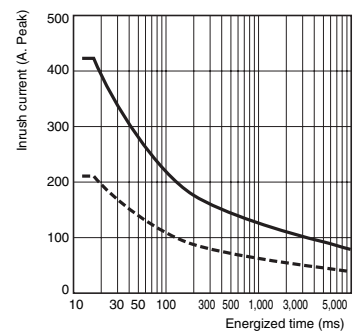

## Close Mounting (3 or 8 SSRs)

**G3PE-215B(L)**

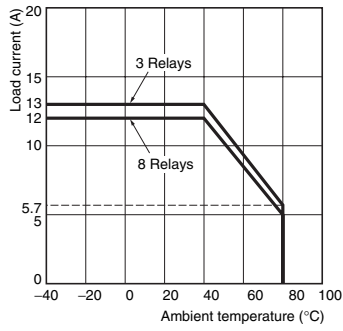

**G3PE-225B(L)**

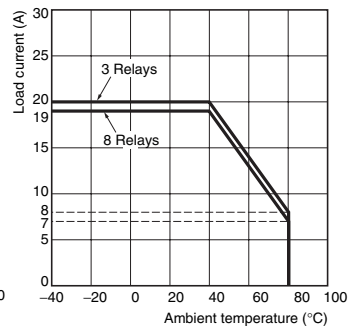

**G3PE-235B(L)**

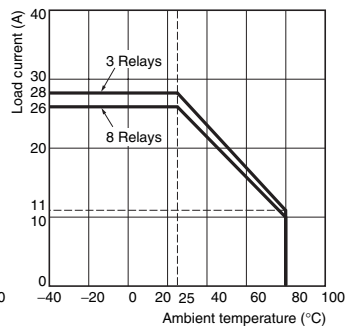

**G3PE-245B(L)**

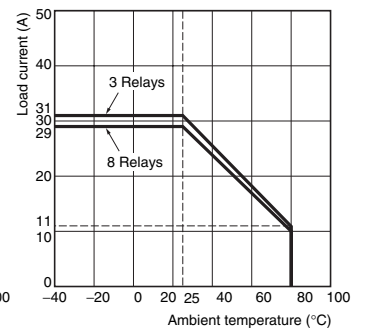

**G3PE-515B(L)**

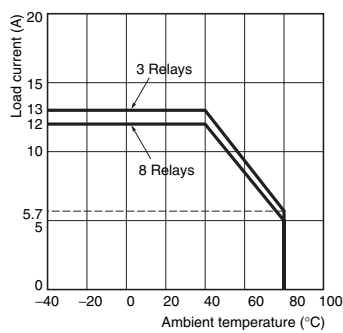

**G3PE-525B(L)**

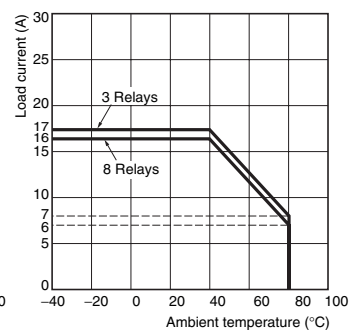

**G3PE-535B(L)**

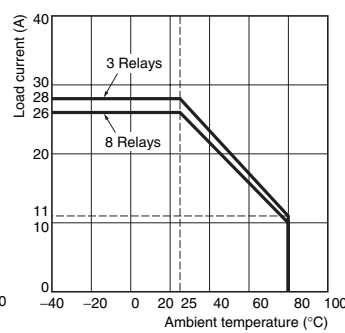

**G3PE-545B(L)**

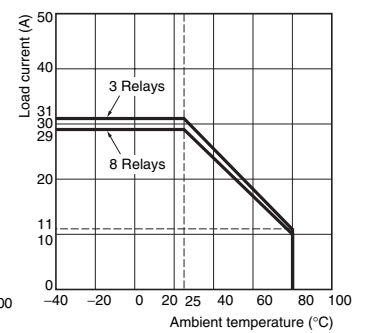

## Close Mounting Example

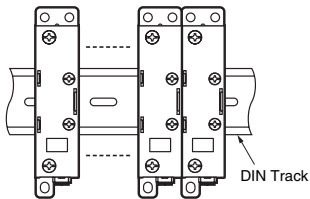

# Dimensions

Note: All units are in millimeters unless otherwise indicated.

## Solid State Relays

- G3PE-215B(L)
- G3PE-225B(L)
- G3PE-515B(L)
- G3PE-525B(L)

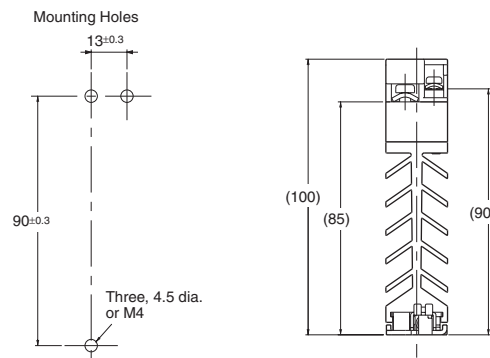
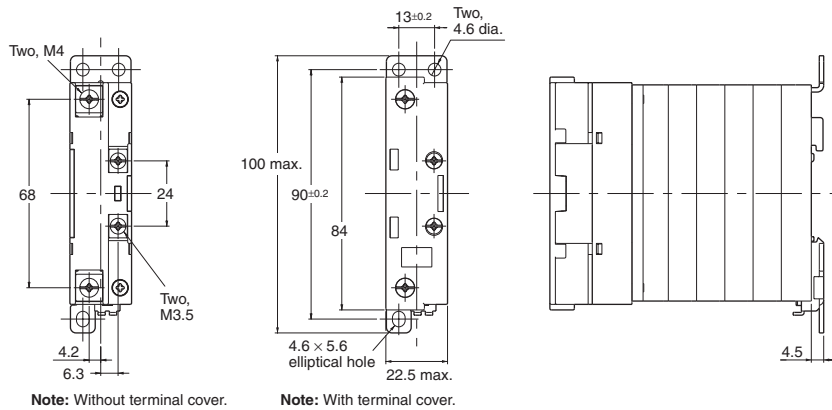

### Terminal Arrangement/Internal Circuit Diagram

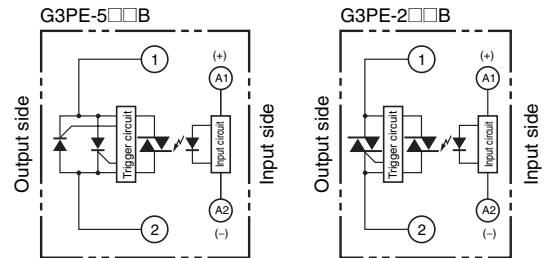

- G3PE-235B(L)
- G3PE-245B(L)
- G3PE-535B(L)
- G3PE-545B(L)

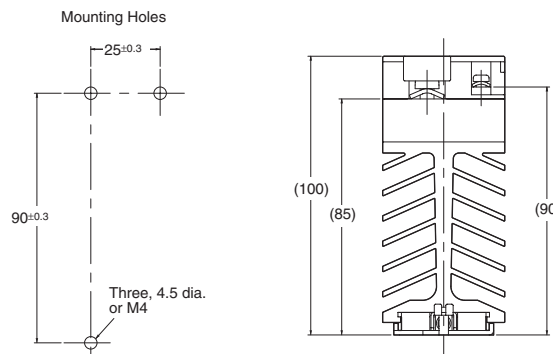
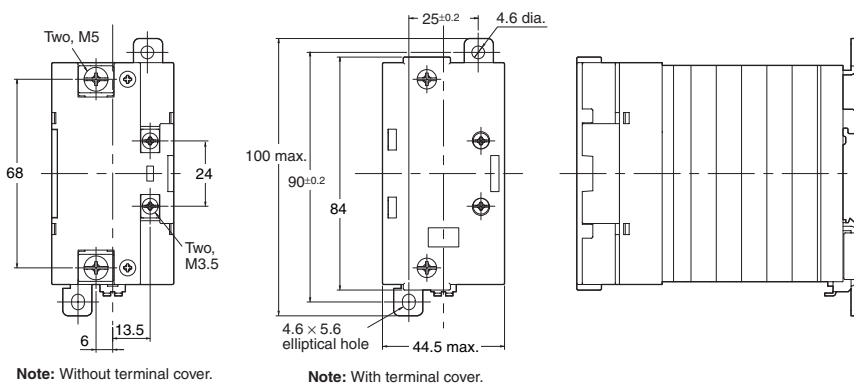

### Terminal Arrangement/Internal Circuit Diagram

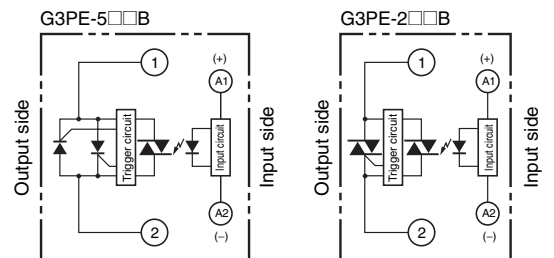

## Read and Understand This Catalog

Please read and understand this catalog before purchasing the products. Please consult your OMRON representative if you have any questions or comments.

## Warranty and Limitations of Liability

### WARRANTY

OMRON's exclusive warranty is that the products are free from defects in materials and workmanship for a period of one year (or other period if specified) from date of sale by OMRON.

OMRON MAKES NO WARRANTY OR REPRESENTATION, EXPRESS OR IMPLIED, REGARDING NON-INFRINGEMENT, MERCHANTABILITY, OR FITNESS FOR PARTICULAR PURPOSE OF THE PRODUCTS. ANY BUYER OR USER ACKNOWLEDGES THAT THE BUYER OR USER ALONE HAS DETERMINED THAT THE PRODUCTS WILL SUITABLY MEET THE REQUIREMENTS OF THEIR INTENDED USE. OMRON DISCLAIMS ALL OTHER WARRANTIES, EXPRESS OR IMPLIED.

### LIMITATIONS OF LIABILITY

OMRON SHALL NOT BE RESPONSIBLE FOR SPECIAL, INDIRECT, OR CONSEQUENTIAL DAMAGES, LOSS OF PROFITS OR COMMERCIAL LOSS IN ANY WAY CONNECTED WITH THE PRODUCTS, WHETHER SUCH CLAIM IS BASED ON CONTRACT, WARRANTY, NEGLIGENCE, OR STRICT LIABILITY.

In no event shall the responsibility of OMRON for any act exceed the individual price of the product on which liability is asserted.

IN NO EVENT SHALL OMRON BE RESPONSIBLE FOR WARRANTY, REPAIR, OR OTHER CLAIMS REGARDING THE PRODUCTS UNLESS OMRON'S ANALYSIS CONFIRMS THAT THE PRODUCTS WERE PROPERLY HANDLED, STORED, INSTALLED, AND MAINTAINED AND NOT SUBJECT TO CONTAMINATION, ABUSE, MISUSE, OR INAPPROPRIATE MODIFICATION OR REPAIR.

## Application Considerations

### SUITABILITY FOR USE

OMRON shall not be responsible for conformity with any standards, codes, or regulations that apply to the combination of products in the customer's application or use of the products.

At the customer's request, OMRON will provide applicable third party certification documents identifying ratings and limitations of use that apply to the products. This information by itself is not sufficient for a complete determination of the suitability of the products in combination with the end product, machine, system, or other application or use.

The following are some examples of applications for which particular attention must be given. This is not intended to be an exhaustive list of all possible uses of the products, nor is it intended to imply that the uses listed may be suitable for the products:

- Outdoor use, uses involving potential chemical contamination or electrical interference, or conditions or uses not described in this catalog.
- Nuclear energy control systems, combustion systems, railroad systems, aviation systems, medical equipment, amusement machines, vehicles, safety equipment, and installations subject to separate industry or government regulations.
- Systems, machines, and equipment that could present a risk to life or property.

Please know and observe all prohibitions of use applicable to the products.

NEVER USE THE PRODUCTS FOR AN APPLICATION INVOLVING SERIOUS RISK TO LIFE OR PROPERTY WITHOUT ENSURING THAT THE SYSTEM AS A WHOLE HAS BEEN DESIGNED TO ADDRESS THE RISKS, AND THAT THE OMRON PRODUCTS ARE PROPERLY RATED AND INSTALLED FOR THE INTENDED USE WITHIN THE OVERALL EQUIPMENT OR SYSTEM.

### PROGRAMMABLE PRODUCTS

OMRON shall not be responsible for the user's programming of a programmable product, or any consequence thereof.

## Disclaimers

### CHANGE IN SPECIFICATIONS

Product specifications and accessories may be changed at any time based on improvements and other reasons.

It is our practice to change model numbers when published ratings or features are changed, or when significant construction changes are made. However, some specifications of the products may be changed without any notice. When in doubt, special model numbers may be assigned to fix or establish key specifications for your application on your request. Please consult with your OMRON representative at any time to confirm actual specifications of purchased products.

### DIMENSIONS AND WEIGHTS

Dimensions and weights are nominal and are not to be used for manufacturing purposes, even when tolerances are shown.

### PERFORMANCE DATA

Performance data given in this catalog is provided as a guide for the user in determining suitability and does not constitute a warranty. It may represent the result of OMRON's test conditions, and the users must correlate it to actual application requirements. Actual performance is subject to the OMRON Warranty and Limitations of Liability.

### ERRORS AND OMISSIONS

The information in this document has been carefully checked and is believed to be accurate; however, no responsibility is assumed for clerical, typographical, or proofreading errors, or omissions.

2010.1

In the interest of product improvement, specifications are subject to change without notice.

**OMRON Corporation**  
Industrial Automation Company

<http://www.ia.omron.com/>

(c)Copyright OMRON Corporation 2010 All Right Reserved.

# G3PE-Three-phase

**Compact, Slim-profile SSRs with Heat Sinks.  
Solid State Contactors for Three-phase  
Heaters Reduced Installation Work  
with DIN Track Mounting.**



- RoHS compliant.
- Surge pass protection improved surge dielectric strength for output currents. (OMRON testing)
- Slim design with 3-phase output and built-in heat sinks.
- DIN Track mounting types and screw mounting types are available.  
All DIN Track mounting types mount to DIN Track (applicable DIN Track: TR35-15Fe (IEC 60715)).
- Conforms to UL, CSA, and EN standards (TÜV certification).

Refer to *Safety Precautions for All G3PE Models.*

## Ordering Information

### List of Models

#### Models with Built-in Heat Sinks

| Number of phases     | Insulation method  | Operation indicator | Rated input voltage | Zero cross function | Type                  | Applicable load *1   | Number of poles      | Model                |
|----------------------|--------------------|---------------------|---------------------|---------------------|-----------------------|----------------------|----------------------|----------------------|
| Three-phase          | Phototriac coupler | Yes (yellow)        | 12 to 24 VDC        | Yes                 | DIN track mounting *2 | 15 A, 100 to 240 VAC | 3                    | G3PE-215B-3N DC12-24 |
|                      |                    |                     |                     |                     |                       |                      | 2                    | G3PE-215B-2N DC12-24 |
|                      |                    |                     |                     |                     |                       | 25 A, 100 to 240 VAC | 3                    | G3PE-225B-3N DC12-24 |
|                      |                    |                     |                     |                     |                       |                      | 2                    | G3PE-225B-2N DC12-24 |
|                      |                    |                     |                     |                     |                       | 35 A, 100 to 240 VAC | 3                    | G3PE-235B-3N DC12-24 |
|                      |                    |                     |                     |                     |                       |                      | 2                    | G3PE-235B-2N DC12-24 |
|                      |                    |                     |                     |                     |                       | 45 A, 100 to 240 VAC | 3                    | G3PE-245B-3N DC12-24 |
|                      |                    |                     |                     |                     |                       |                      | 2                    | G3PE-245B-2N DC12-24 |
|                      |                    |                     |                     |                     |                       | 15 A, 200 to 480 VAC | 3                    | G3PE-515B-3N DC12-24 |
|                      |                    |                     |                     |                     |                       |                      | 2                    | G3PE-515B-2N DC12-24 |
|                      |                    |                     |                     |                     |                       | 25 A, 200 to 480 VAC | 3                    | G3PE-525B-3N DC12-24 |
|                      |                    |                     |                     |                     |                       |                      | 2                    | G3PE-525B-2N DC12-24 |
|                      |                    |                     |                     |                     | 35 A, 200 to 480 VAC  | 3                    | G3PE-535B-3N DC12-24 |                      |
|                      |                    |                     |                     |                     |                       | 2                    | G3PE-535B-2N DC12-24 |                      |
|                      |                    |                     |                     |                     | 45 A, 200 to 480 VAC  | 3                    | G3PE-545B-3N DC12-24 |                      |
|                      |                    |                     |                     |                     |                       | 2                    | G3PE-545B-2N DC12-24 |                      |
|                      |                    |                     |                     |                     | Screw mounting        | 15 A, 100 to 240 VAC | 3                    | G3PE-215B-3 DC12-24  |
|                      |                    |                     |                     |                     |                       |                      | 2                    | G3PE-215B-2 DC12-24  |
|                      |                    |                     |                     |                     |                       | 25 A, 100 to 240 VAC | 3                    | G3PE-225B-3 DC12-24  |
|                      |                    |                     |                     |                     |                       |                      | 2                    | G3PE-225B-2 DC12-24  |
|                      |                    |                     |                     |                     |                       | 35 A, 100 to 240 VAC | 3                    | G3PE-235B-3 DC12-24  |
|                      |                    |                     |                     |                     |                       |                      | 2                    | G3PE-235B-2 DC12-24  |
|                      |                    |                     |                     |                     |                       | 45 A, 100 to 240 VAC | 3                    | G3PE-245B-3 DC12-24  |
|                      |                    |                     |                     |                     |                       |                      | 2                    | G3PE-245B-2 DC12-24  |
| 15 A, 200 to 480 VAC | 3                  | G3PE-515B-3 DC12-24 |                     |                     |                       |                      |                      |                      |
|                      | 2                  | G3PE-515B-2 DC12-24 |                     |                     |                       |                      |                      |                      |
| 25 A, 200 to 480 VAC | 3                  | G3PE-525B-3 DC12-24 |                     |                     |                       |                      |                      |                      |
|                      | 2                  | G3PE-525B-2 DC12-24 |                     |                     |                       |                      |                      |                      |
| 35 A, 200 to 480 VAC | 3                  | G3PE-535B-3 DC12-24 |                     |                     |                       |                      |                      |                      |
|                      | 2                  | G3PE-535B-2 DC12-24 |                     |                     |                       |                      |                      |                      |
| 45 A, 200 to 480 VAC | 3                  | G3PE-545B-3 DC12-24 |                     |                     |                       |                      |                      |                      |
|                      | 2                  | G3PE-545B-2 DC12-24 |                     |                     |                       |                      |                      |                      |

\*1. The applicable load current depends on the ambient temperature. For details, refer to *Load Current vs. Ambient Temperature* in *Engineering Data* on page 5.

\*2. The applicable DIN Track is the TR35-15Fe (IEC 60715). For details, refer to the mounting information in the *Safety Precautions for All G3PE Models*.

## Models with Externally Attached Heat Sinks

| Number of phases | Insulation method  | Operation indicator | Rated input voltage | Zero cross function | Type                           | Applicable load *    | Number of poles | Model                |
|------------------|--------------------|---------------------|---------------------|---------------------|--------------------------------|----------------------|-----------------|----------------------|
| Three-phase      | Phototriac coupler | Yes (yellow)        | 12 to 24 VDC        | Yes                 | Externally attached heat sinks | 15 A, 100 to 240 VAC | 3               | G3PE-215B-3H DC12-24 |
|                  |                    |                     |                     |                     |                                |                      | 2               | G3PE-215B-2H DC12-24 |
|                  |                    |                     |                     |                     |                                | 25 A, 100 to 240 VAC | 3               | G3PE-225B-3H DC12-24 |
|                  |                    |                     |                     |                     |                                |                      | 2               | G3PE-225B-2H DC12-24 |
|                  |                    |                     |                     |                     |                                | 35 A, 100 to 240 VAC | 3               | G3PE-235B-3H DC12-24 |
|                  |                    |                     |                     |                     |                                |                      | 2               | G3PE-235B-2H DC12-24 |
|                  |                    |                     |                     |                     |                                | 45 A, 100 to 240 VAC | 3               | G3PE-245B-3H DC12-24 |
|                  |                    |                     |                     |                     |                                |                      | 2               | G3PE-245B-2H DC12-24 |
|                  |                    |                     |                     |                     |                                | 15 A, 200 to 480 VAC | 3               | G3PE-515B-3H DC12-24 |
|                  |                    |                     |                     |                     |                                |                      | 2               | G3PE-515B-2H DC12-24 |
|                  |                    |                     |                     |                     |                                | 25 A, 200 to 480 VAC | 3               | G3PE-525B-3H DC12-24 |
|                  |                    |                     |                     |                     |                                |                      | 2               | G3PE-525B-2H DC12-24 |
|                  |                    |                     |                     |                     |                                | 35 A, 200 to 480 VAC | 3               | G3PE-535B-3H DC12-24 |
|                  |                    |                     |                     |                     |                                |                      | 2               | G3PE-535B-2H DC12-24 |
|                  |                    |                     |                     |                     |                                | 45 A, 200 to 480 VAC | 3               | G3PE-545B-3H DC12-24 |
|                  |                    |                     |                     |                     |                                |                      | 2               | G3PE-545B-2H DC12-24 |

\* The rated load current depends on the heat sink or radiator that is mounted. It also depends on the ambient temperature. For details, refer to *Load Current vs. Ambient Temperature*.

## Accessories (Order Separately)

### Heat Sink

| Heat resistance Rth (s-a) (°C/W) | Model     |
|----------------------------------|-----------|
| 1.67                             | Y92B-P50  |
| 1.01                             | Y92B-P100 |
| 0.63                             | Y92B-P150 |
| 0.43                             | Y92B-P200 |
| 0.36                             | Y92B-P250 |



## Specifications

### Certification

UL508, CSA22.2 No.14, and EN60947-4-3

### Ratings (at an Ambient Temperature of 25°C)

#### Operating Circuit (All Models)

| Item                            | Model | Same for all models |
|---------------------------------|-------|---------------------|
| Rated operating voltage         |       | 12 to 24 VDC        |
| Operating voltage range         |       | 9.6 to 30 VDC       |
| Rated input current (impedance) |       | 10 mA max. (24 VDC) |
| Must-operate voltage            |       | 9.6 VDC max.        |
| Must-release voltage            |       | 1 VDC min.          |
| Insulation method               |       | Phototriac          |
| Operation indicator             |       | Yellow LED          |

#### Main Circuit of Models with Built-in Heat Sinks

| Item   | Model | G3PE-215B-3(N)            | G3PE-215B-2(N)            | G3PE-225B-3(N)            | G3PE-225B-2(N)          | G3PE-235B-3(N)          | G3PE-235B-2(N)          | G3PE-245B-3(N)            | G3PE-245B-2(N)          | G3PE-515B-3(N) | G3PE-515B-2(N) | G3PE-525B-3(N)            | G3PE-525B-2(N) | G3PE-535B-3(N) | G3PE-535B-2(N) | G3PE-545B-3(N) | G3PE-545B-2(N) |
|--|-------|---------------------------|---------------------------|---------------------------|-------------------------|-------------------------|-------------------------|---------------------------|-------------------------|----------------|----------------|---------------------------|----------------|----------------|----------------|----------------|----------------|
| Rated load voltage                             |       | 100 to 240 VAC            |                           |                           |                         |                         |                         |                           |                         | 200 to 480 VAC |                |                           |                |                |                |                |                |
| Operating voltage range                        |       | 75 to 264 VAC             |                           |                           |                         |                         |                         |                           |                         | 180 to 528 VAC |                |                           |                |                |                |                |                |
| Rated load current *1                          |       | 15 A (at 40°C)            | 25 A (at 40°C)            | 35 A (at 25°C)            | 45 A (at 25°C)          | 15 A (at 40°C)          | 25 A (at 40°C)          | 35 A (at 25°C)            | 45 A (at 25°C)          |                |                |                           |                |                |                |                |                |
| Minimum load current                           |       | 0.2 A                     |                           |                           |                         |                         |                         |                           |                         | 0.5 A          |                |                           |                |                |                |                |                |
| Inrush current resistance (peak value)         |       | 150 A<br>(60 Hz, 1 cycle) | 220 A<br>(60 Hz, 1 cycle) | 440 A<br>(60 Hz, 1 cycle) |                         |                         |                         | 220 A<br>(60 Hz, 1 cycle) |                         |                |                | 440 A<br>(60 Hz, 1 cycle) |                |                |                |                |                |
| Permissible I <sup>2</sup> t (reference value) |       | 121A <sup>2</sup> s       | 260A <sup>2</sup> s       | 1,260A <sup>2</sup> s     |                         |                         |                         | 260A <sup>2</sup> s       |                         |                |                | 1,260A <sup>2</sup> s     |                |                |                |                |                |
| Applicable load (resistive load: AC1 class) *2 |       | 5.1 kW<br>(at 200 VAC)    | 8.6 kW<br>(at 200 VAC)    | 12.1 kW<br>(at 200 VAC)   | 15.5 kW<br>(at 200 VAC) | 12.5 kW<br>(at 480 VAC) | 20.7 kW<br>(at 480 VAC) | 29.0 kW<br>(at 480 VAC)   | 37.4 kW<br>(at 480 VAC) |                |                |                           |                |                |                |                |                |

\*1. The applicable load current depends on the ambient temperature. For details, refer to *Load Current vs. Ambient Temperature* in *Engineering Data* on page 5.

\*2. Applicable Load

Use the following formula to calculate the maximum total capacity of a heater load for a three-phase balanced load with delta connections.

Maximum load capacity = Load current × Load voltage ×  $\sqrt{3}$

Example: 15 A × 200 V ×  $\sqrt{3}$  = 5,196 W ≅ 5.1 kW

Example: 15 A × 400 V ×  $\sqrt{3}$  = 10,392 W ≅ 10.3 kW

#### Main Circuit of Models with Externally Attached Heat Sinks

| Item   | Model | G3PE-215B-3H                                | G3PE-215B-2H              | G3PE-225B-3HH             | G3PE-225B-2H   | G3PE-235B-3H   | G3PE-235B-2H   | G3PE-245B-3H              | G3PE-245B-2H   | G3PE-515B-3H   | G3PE-515B-2H | G3PE-525B-3H              | G3PE-525B-2H | G3PE-535B-3H | G3PE-535B-2H | G3PE-545B-3H | G3PE-545B-2H |
|--|-------|---|---------------------------|---------------------------|----------------|----------------|----------------|---------------------------|----------------|----------------|--------------|---------------------------|--------------|--------------|--------------|--------------|--------------|
| Rated load voltage                             |       | 100 to 240 VAC                              |                           |                           |                |                |                |                           |                | 200 to 480 VAC |              |                           |              |              |              |              |              |
| Operating voltage range                        |       | 75 to 264 VAC                               |                           |                           |                |                |                |                           |                | 180 to 528 VAC |              |                           |              |              |              |              |              |
| Rated load current *                           |       | 15 A (at 40°C)                              | 25 A (at 40°C)            | 35 A (at 25°C)            | 45 A (at 25°C) | 15 A (at 40°C) | 25 A (at 40°C) | 35 A (at 25°C)            | 45 A (at 25°C) |                |              |                           |              |              |              |              |              |
| Minimum load current                           |       | 0.2 A                                       |                           |                           |                |                |                |                           |                | 0.5 A          |              |                           |              |              |              |              |              |
| Inrush current resistance (peak value)         |       | 150 A<br>(60 Hz, 1 cycle)                   | 220 A<br>(60 Hz, 1 cycle) | 440 A<br>(60 Hz, 1 cycle) |                |                |                | 220 A<br>(60 Hz, 1 cycle) |                |                |              | 440 A<br>(60 Hz, 1 cycle) |              |              |              |              |              |
| Permissible I <sup>2</sup> t (reference value) |       | 121A <sup>2</sup> s                         | 260A <sup>2</sup> s       | 1,260A <sup>2</sup> s     |                |                |                | 260A <sup>2</sup> s       |                |                |              | 1,260A <sup>2</sup> s     |              |              |              |              |              |
| Applicable load (resistive load: AC1 class)    |       | Refer to <i>Engineering Data</i> on page 5. |                           |                           |                |                |                |                           |                |                |              |                           |              |              |              |              |              |

\* The rated load current depends on the heat sink or radiator that is mounted. It also depends on the ambient temperature.

For details, refer to *Load Current vs. Ambient Temperature* in *Engineering Data* on page 5.

## Characteristics

### Models with Built-in Heat Sinks

| Model                         | G3PE-215B-3(N)   | G3PE-215B-2(N)  | G3PE-225B-3(N)  | G3PE-225B-2(N)  | G3PE-235B-3(N)  | G3PE-235B-2(N) | G3PE-245B-3(N)  | G3PE-245B-2(N)  | G3PE-515B-3(N)          | G3PE-515B-2(N)  | G3PE-525B-3(N)  | G3PE-525B-2(N)  | G3PE-535B-3(N) | G3PE-535B-2(N)  | G3PE-545B-3(N) | G3PE-545B-2(N)  |
|-------------------------------|--|-----------------|-----------------|-----------------|-----------------|----------------|-----------------|-----------------|-------------------------|-----------------|-----------------|-----------------|----------------|-----------------|----------------|-----------------|
| Operate time                  | 1/2 of load power source cycle + 1 ms max.   |                 |                 |                 |                 |                |                 |                 |                         |                 |                 |                 |                |                 |                |                 |
| Release time                  | 1/2 of load power source cycle + 1 ms max.   |                 |                 |                 |                 |                |                 |                 |                         |                 |                 |                 |                |                 |                |                 |
| Output ON voltage drop        | 1.6 V (RMS) max.   |                 |                 |                 |                 |                |                 |                 | 1.8 V (RMS) max.        |                 |                 |                 |                |                 |                |                 |
| Leakage current *             | 10 mA max. (at 200 VAC)  |                 |                 |                 |                 |                |                 |                 | 20 mA max. (at 480 VAC) |                 |                 |                 |                |                 |                |                 |
| Insulation resistance         | 100 MΩ min. (at 500 VDC)   |                 |                 |                 |                 |                |                 |                 |                         |                 |                 |                 |                |                 |                |                 |
| Dielectric strength           | 2,500 VAC, 50/60 Hz for 1 min  |                 |                 |                 |                 |                |                 |                 |                         |                 |                 |                 |                |                 |                |                 |
| Vibration resistance          | <ul style="list-style-type: none"> <li>DIN Track mounting: 10 to 55 to 10 Hz, 0.175-mm single amplitude (0.35-mm double amplitude)</li> <li>Screw mounting: 10 to 55 to 10 Hz, 0.375-mm single amplitude (0.75-mm double amplitude)</li> </ul> |                 |                 |                 |                 |                |                 |                 |                         |                 |                 |                 |                |                 |                |                 |
| Shock resistance              | 294 m/s <sup>2</sup> (reverse mounting: 98 m/s <sup>2</sup> )  |                 |                 |                 |                 |                |                 |                 |                         |                 |                 |                 |                |                 |                |                 |
| Ambient storage temperature   | -30 to 100°C (with no icing or condensation)   |                 |                 |                 |                 |                |                 |                 |                         |                 |                 |                 |                |                 |                |                 |
| Ambient operating temperature | -30 to 80°C (with no icing or condensation)  |                 |                 |                 |                 |                |                 |                 |                         |                 |                 |                 |                |                 |                |                 |
| Ambient operating humidity    | 45% to 85%   |                 |                 |                 |                 |                |                 |                 |                         |                 |                 |                 |                |                 |                |                 |
| Weight                        | Approx. 1.25 kg  | Approx. 1.45 kg | Approx. 1.25 kg | Approx. 1.65 kg | Approx. 1.45 kg | Approx. 2.0 kg | Approx. 1.65 kg | Approx. 1.25 kg | Approx. 1.45 kg         | Approx. 1.25 kg | Approx. 1.65 kg | Approx. 1.45 kg | Approx. 2.0 kg | Approx. 1.65 kg | Approx. 2.0 kg | Approx. 1.65 kg |

\* The leakage current of phase S will be approximately  $\sqrt{3}$  times larger if the 2-element model is used.

### Models with Externally Attached Heat Sinks

| Model                         | G3PE-215B-3H  | G3PE-215B-2H | G3PE-225B-3H | G3PE-225B-2H | G3PE-235B-3H | G3PE-235B-2H | G3PE-245B-3H | G3PE-245B-2H | G3PE-515B-3H            | G3PE-515B-2H | G3PE-525B-3H | G3PE-525B-2H | G3PE-535B-3H | G3PE-535B-2H | G3PE-545B-3H | G3PE-545B-2H |
|-------------------------------|---|--------------|--------------|--------------|--------------|--------------|--------------|--------------|-------------------------|--------------|--------------|--------------|--------------|--------------|--------------|--------------|
| Operate time                  | 1/2 of load power source cycle + 1 ms max.                              |              |              |              |              |              |              |              |                         |              |              |              |              |              |              |              |
| Release time                  | 1/2 of load power source cycle + 1 ms max.                              |              |              |              |              |              |              |              |                         |              |              |              |              |              |              |              |
| Output ON voltage drop        | 1.6 V (RMS) max.  |              |              |              |              |              |              |              | 1.8 V (RMS) max.        |              |              |              |              |              |              |              |
| Leakage current *             | 10 mA max. (at 200 VAC)   |              |              |              |              |              |              |              | 20 mA max. (at 480 VAC) |              |              |              |              |              |              |              |
| Insulation resistance         | 100 MΩ min. (at 500 VDC)  |              |              |              |              |              |              |              |                         |              |              |              |              |              |              |              |
| Dielectric strength           | 2,500 VAC, 50/60 Hz for 1 min   |              |              |              |              |              |              |              |                         |              |              |              |              |              |              |              |
| Vibration resistance          | 10 to 55 to 10 Hz, 0.375-mm single amplitude (0.75-mm double amplitude) |              |              |              |              |              |              |              |                         |              |              |              |              |              |              |              |
| Shock resistance              | Destruction: 294 m/s <sup>2</sup>                                       |              |              |              |              |              |              |              |                         |              |              |              |              |              |              |              |
| Ambient storage temperature   | -30 to 100°C (with no icing or condensation)                            |              |              |              |              |              |              |              |                         |              |              |              |              |              |              |              |
| Ambient operating temperature | -30 to 80°C (with no icing or condensation)                             |              |              |              |              |              |              |              |                         |              |              |              |              |              |              |              |
| Ambient operating humidity    | 45% to 85%  |              |              |              |              |              |              |              |                         |              |              |              |              |              |              |              |
| Weight                        | Approx. 300 g   |              |              |              |              |              |              |              |                         |              |              |              |              |              |              |              |

\* The leakage current of phase S will be approximately  $\sqrt{3}$  times larger if the 2-element model is used.

### Heat Sinks

| Model     | Weight          |
|-----------|-----------------|
| Y92B-P50  | Approx. 450 g   |
| Y92B-P100 | Approx. 450 g   |
| Y92B-P150 | Approx. 600 g   |
| Y92B-P200 | Approx. 850 g   |
| Y92B-P250 | Approx. 1,200 g |

## Engineering Data

### Input Voltage vs. Input Impedance and Input Voltage vs. Input Current

G3PE-2□□B-□□

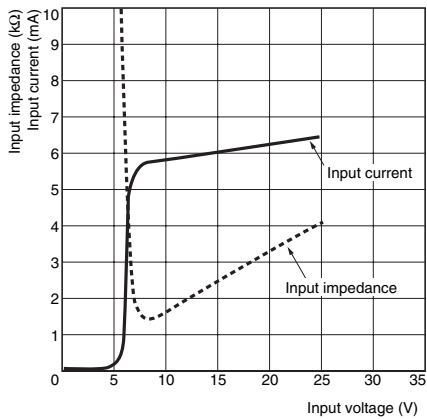

G3PE-5□□B-□□

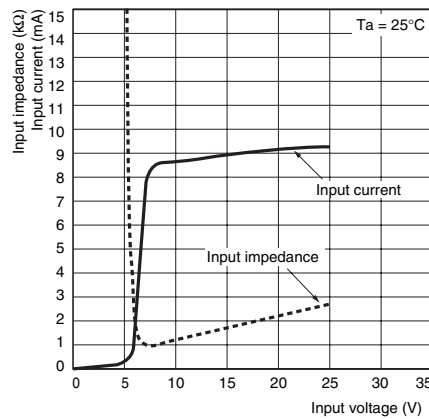

### Load Current vs. Ambient Temperature

#### Models with Built-in Heat Sinks

G3PE-215B-3(N), G3PE-225B-3(N)

G3PE-215B-2(N), G3PE-225B-2(N)

G3PE-515B-3(N), G3PE-525B-3(N)

G3PE-515B-2(N), G3PE-525B-2(N)

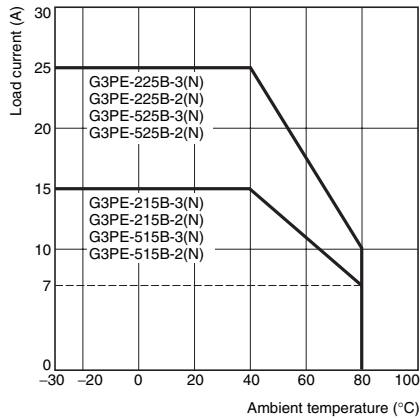

G3PE-235B-3(N), G3PE-245B-3(N)

G3PE-235B-2(N), G3PE-245B-2(N)

G3PE-535B-3(N), G3PE-545B-3(N)

G3PE-535B-2(N), G3PE-545B-2(N)

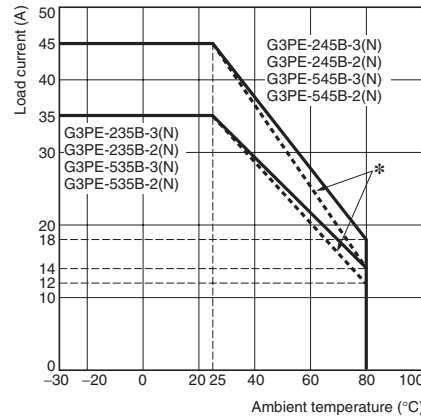

\* The dotted lines in the charts are the UL derating curves for the G3PE-235B-3(N), G3PE-245B-3(N), G3PE-235B-2(N), G3PE-245B-2(N), G3PE-535B-3(N), G3PE-545B-3(N), G3PE-535B-2(N), G3PE-545B-2(N).

#### Models with Externally Attached Heat Sinks

G3PE-215B-3H(-2H)

G3PE-225B-3H(-2H)

G3PE-515B-3H(-2H)

G3PE-525B-3H(-2H)

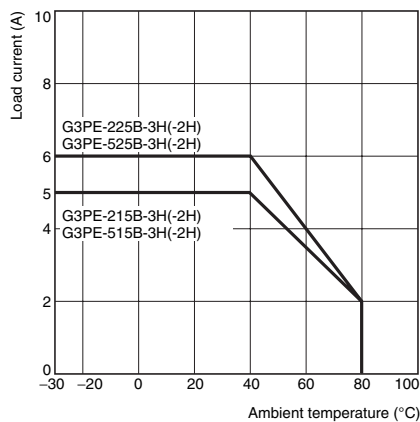

G3PE-235B-3H(-2H)

G3PE-245B-3H(-2H)

G3PE-535B-3H(-2H)

G3PE-545B-3H(-2H)

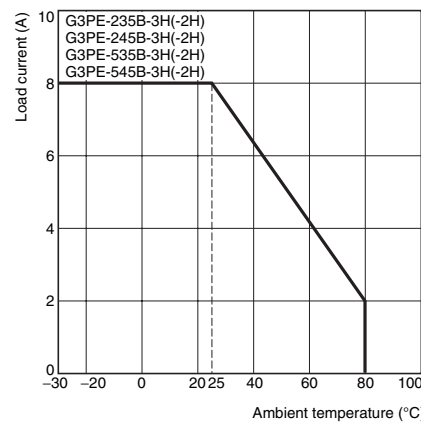

## Inrush Current Resistance: Non-repetitive

Keep the inrush current to below the inrush current resistance value (i.e., below the broken line) if it occurs repetitively.

G3PE-215B-3(N)(H)  
G3PE-215B-2(N)(H)

G3PE-225B-3(N)(H), G3PE-525B-3(N)(H)  
G3PE-225B-2(N)(H), G3PE-525B-2(N)(H)  
G3PE-515B-3(N)(H),  
G3PE-515B-2(N)(H),

G3PE-235B-3(N)(H), G3PE-535B-3(N)(H)  
G3PE-235B-2(N)(H), G3PE-535B-2(N)(H)  
G3PE-245B-3(N)(H), G3PE-545B-3(N)(H)  
G3PE-245B-2(N)(H), G3PE-545B-2(N)(H)

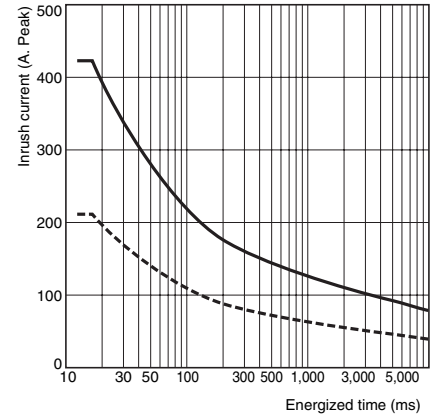
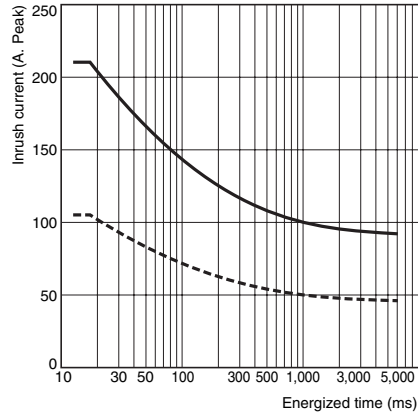
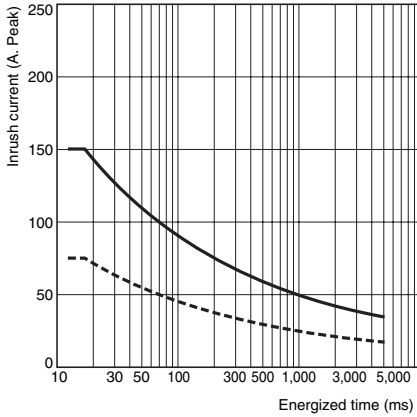

## Heat Sink Area vs. Load Current (40°C and 80°C)

G3PE-225B-3H

G3PE-525B-3H

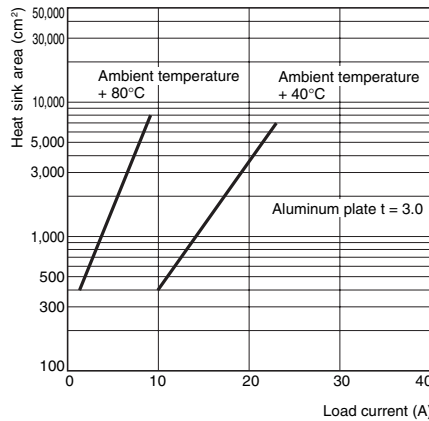
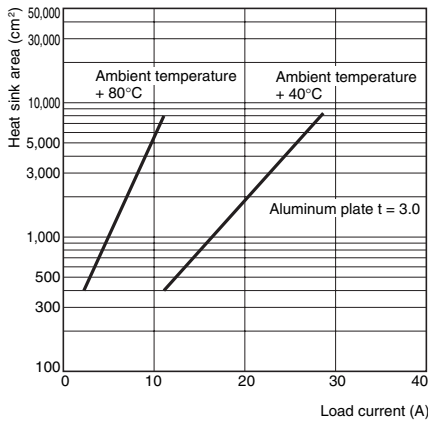

**Note:** The heat sink area is the combined area of all surfaces of the heat sink that radiate heat.  
For the G3PE-525B-3H, when a current of 18 A flows through the SSR at 40°C, the graph shows that a heat sink area of about 2,500 cm<sup>2</sup> would be required. Therefore, if the heat sink is square, one side of an aluminum plate in the heat sink must be 36 cm or longer ( $\sqrt{2,500 \text{ (cm}^2\text{)}/2} = 36 \text{ cm}$  (rounded to a whole number)).

## Models with Externally Attached Heat Sinks

### Heat Resistance R<sub>th</sub> (Junction/SSR Back Surface)

| Model        | R <sub>th</sub> (°C/W) |
|--------------|------------------------|
| G3PE-215B-3H | 1.05                   |
| G3PE-225B-3H | 0.57                   |
| G3PE-235B-3H | 0.57                   |
| G3PE-245B-3H | 0.57                   |

### Heat Resistance of Heat Sinks

| Model     | R <sub>th</sub> (°C/W) |
|-----------|------------------------|
| Y92B-P50  | 1.67                   |
| Y92B-P100 | 1.01                   |
| Y92B-P150 | 0.63                   |
| Y92B-P200 | 0.43                   |
| Y92B-P250 | 0.36                   |

**Note:** If a commercially available heat sink is used, use one that has a heat resistance equal to or lower than a standard OMRON Heat Sink.

# Dimensions

Note: All units are in millimeters unless otherwise indicated.

## Solid State Relays

### Models with DIN Track Mounting

- G3PE-215B-3N
- G3PE-215B-2N
- G3PE-225B-2N
- G3PE-515B-3N
- G3PE-515B-2N
- G3PE-525B-2N

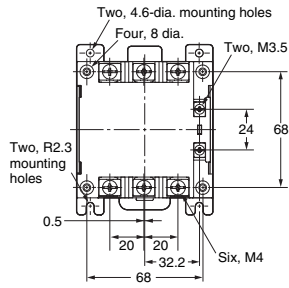

Note: Without terminal cover.

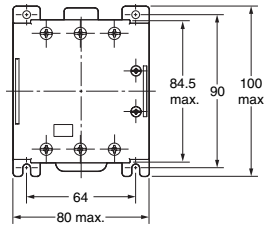

Note: With terminal cover.

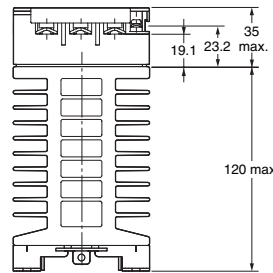
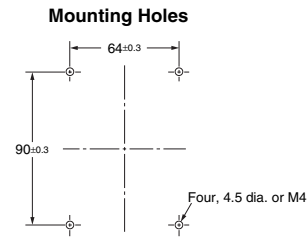
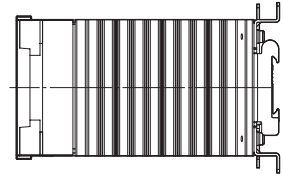

### Terminal Arrangement/Internal Circuit Diagram

G3PE-215B-3N

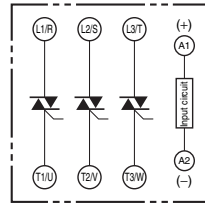

G3PE-2□5B-2N

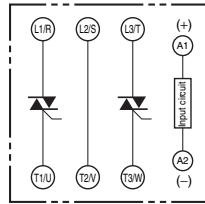

G3PE-515E-3N

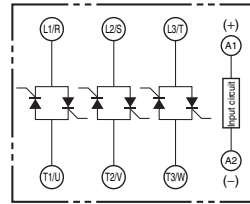

G3PE-5□5B-2N

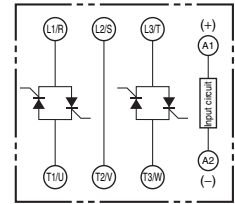

### Models with DIN Track Mounting

- G3PE-225B-3N
- G3PE-235B-2N
- G3PE-525B-3N
- G3PE-535B-2N

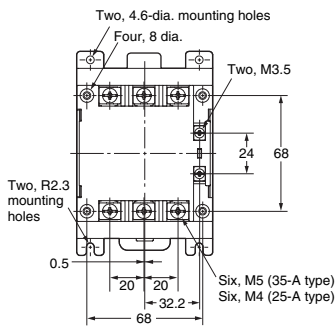

Note: Without terminal cover.

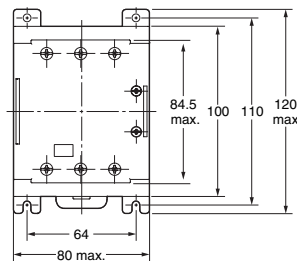

Note: With terminal cover.

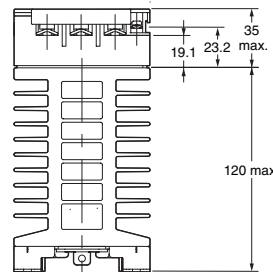
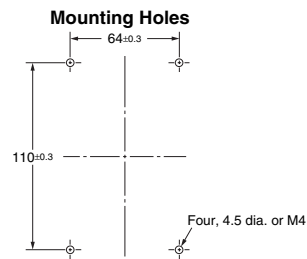
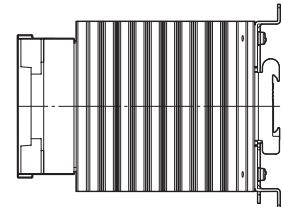

### Terminal Arrangement/Internal Circuit Diagram

G3PE-225B-3N

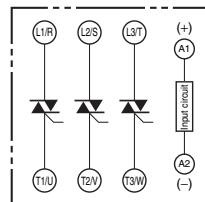

G3PE-235B-2N

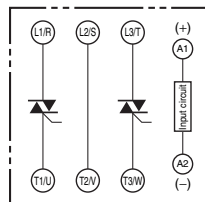

G3PE-525B-3N

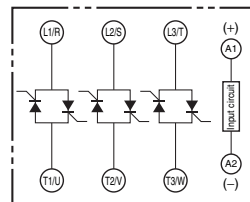

G3PE-535B-2N

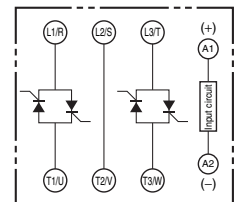

## Models with DIN Track Mounting

- G3PE-235B-3N
- G3PE-245B-2N
- G3PE-535B-3N
- G3PE-545B-2N

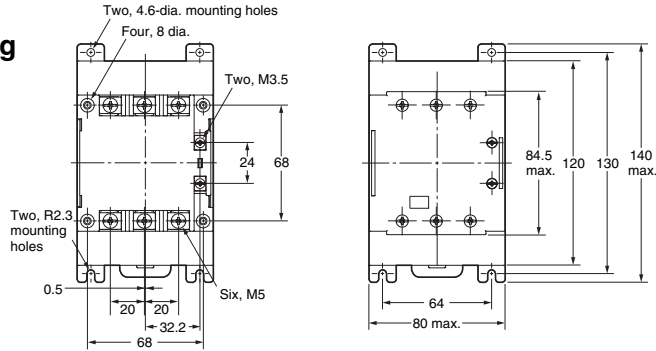

**Note:** Without terminal cover.

**Note:** With terminal cover.

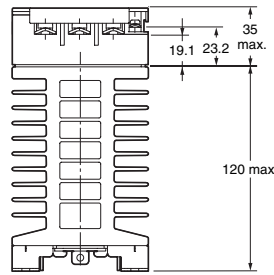
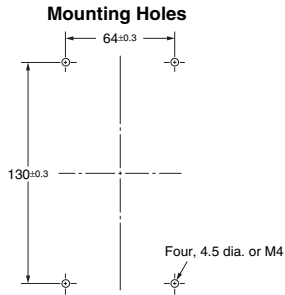

### Terminal Arrangement/Internal Circuit Diagram

G3PE-235B-3N

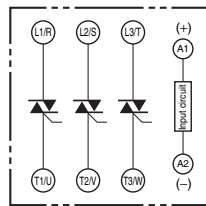

G3PE-245B-2N

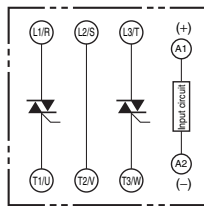

G3PE-535B-3N

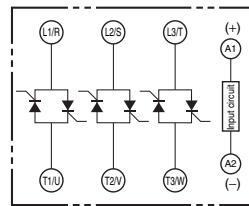

G3PE-545B-2N

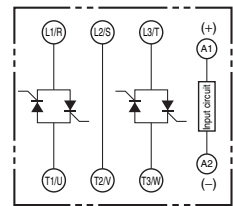

## Models with DIN Track Mounting

- G3PE-245B-3N
- G3PE-545B-3N

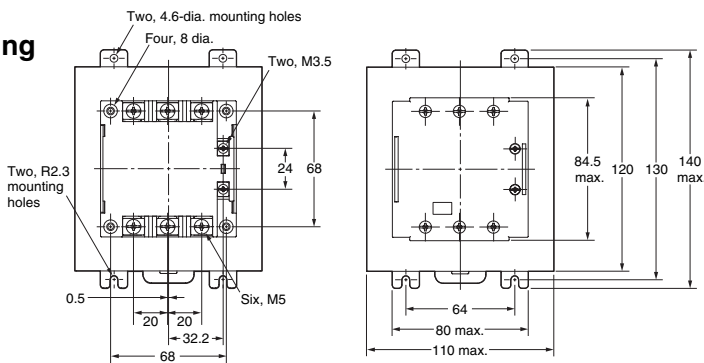

**Note:** Without terminal cover.

**Note:** With terminal cover.

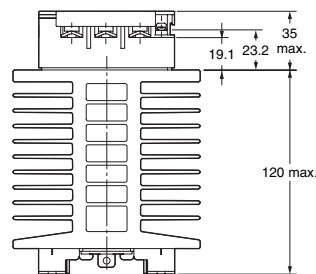
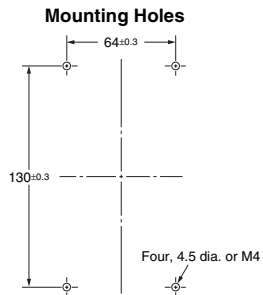

### Terminal Arrangement/Internal Circuit Diagram

G3PE245B-3N

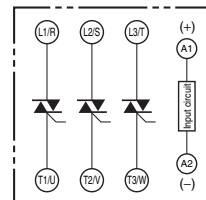

G3PE-545B-3N

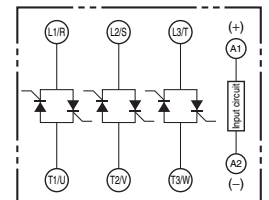

## Models with Screw Mounting

G3PE-215B-2  
G3PE-515B-2



DIN Track or screw mounting

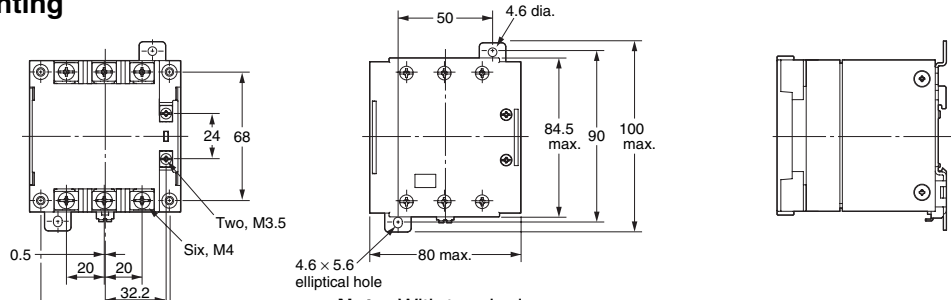

Note: Without terminal cover.

Note: With terminal cover.

### Mounting Holes

Two, 4.5 dia. or M4

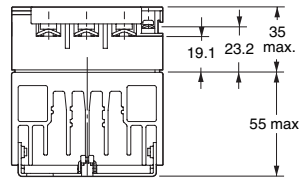
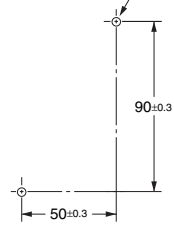

### Terminal Arrangement/Internal Circuit Diagram

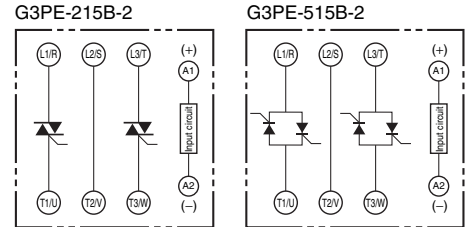

## Models with Screw Mounting

G3PE-215B-3  
G3PE-225B-2  
G3PE-515B-3  
G3PE-525B-2

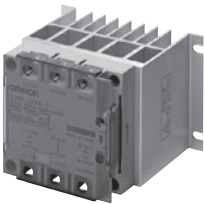

For screw mounting only

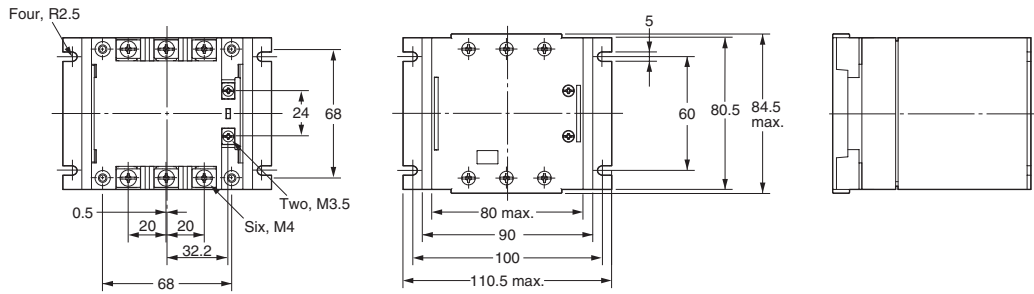

Note: Without terminal cover.

Note: With terminal cover.

### Mounting Holes

Four, 4.5 dia. or M4

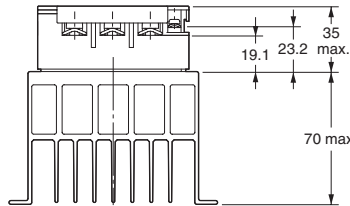
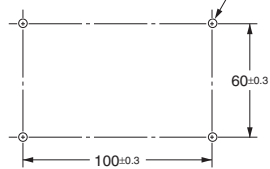

### Terminal Arrangement/Internal Circuit Diagram

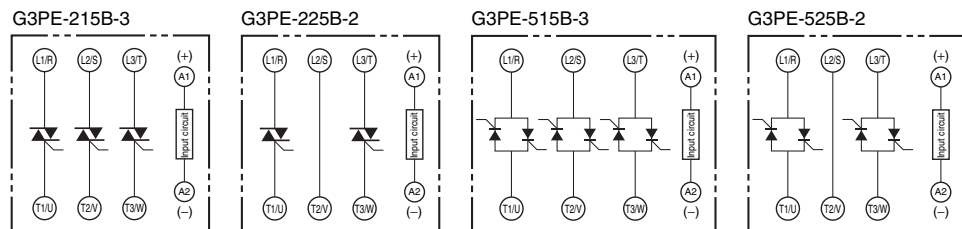

## Models with Screw Mounting

G3PE-225B-3  
G3PE-235B-2  
G3PE-525B-3  
G3PE-535B-2



For screw mounting only

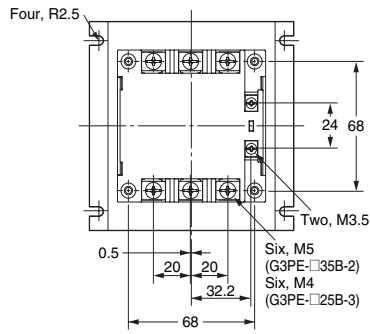

Note: Without terminal cover.

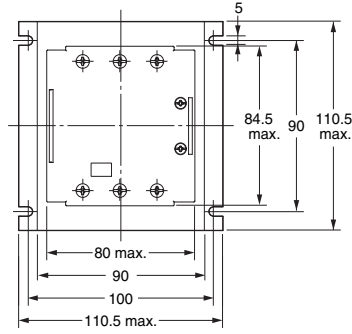

Note: With terminal cover.

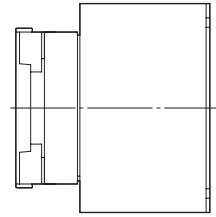

### Mounting Holes

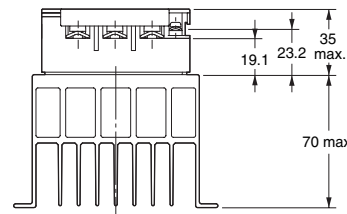
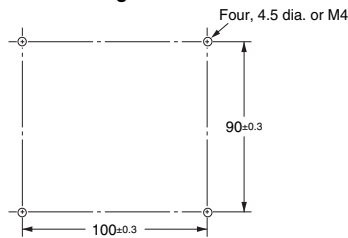

### Terminal Arrangement/Internal Circuit Diagram

G3PE-225B-3

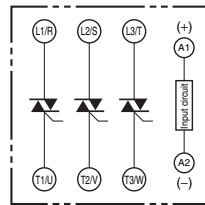

G3PE-235B-2

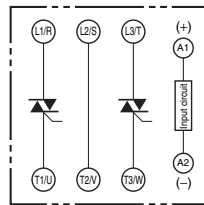

G3PE-525B-3

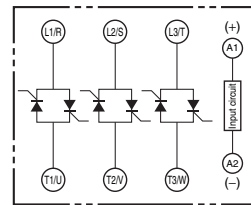

G3PE-535B-2

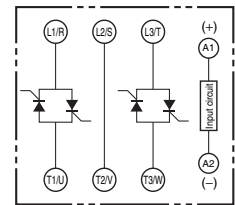

## Models with Screw Mounting

G3PE-235B-3  
G3PE-245B-2  
G3PE-535B-3  
G3PE-545B-2



For screw mounting only

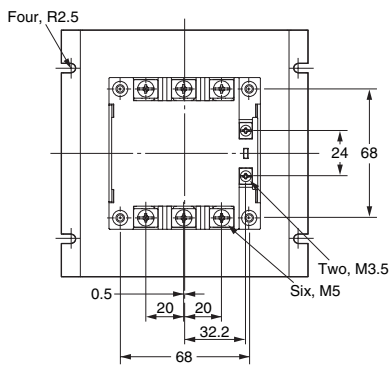

Note: Without terminal cover.

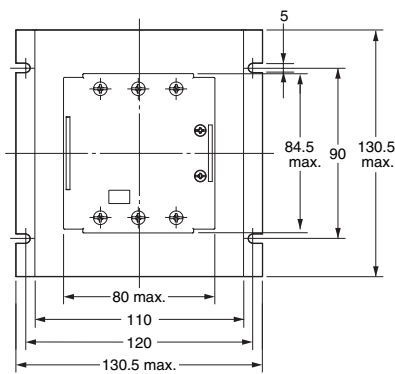

Note: With terminal cover.

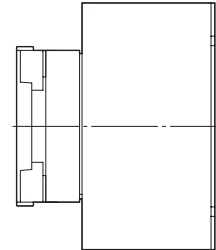

### Mounting Holes

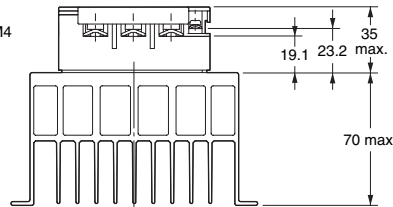
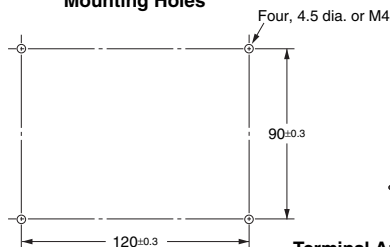

### Terminal Arrangement/Internal Circuit Diagram

G3PE-235B-3

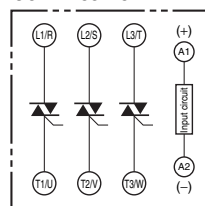

G3PE-245B-2

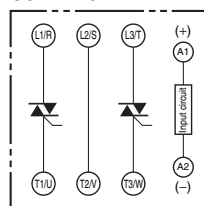

G3PE-535B-3

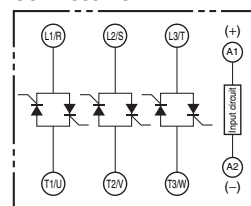

G3PE-545B-2

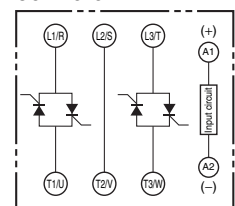



## Models with Screw Mounting

G3PE-245B-3  
G3PE-545B-3



For screw mounting only

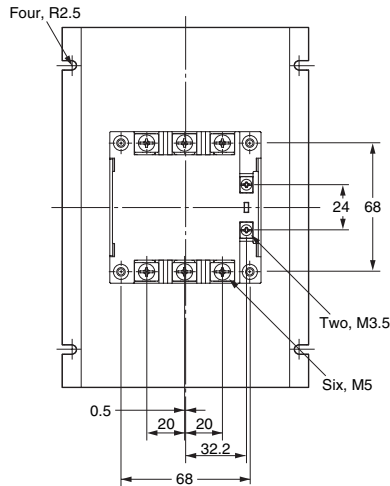

Note: Without terminal cover.

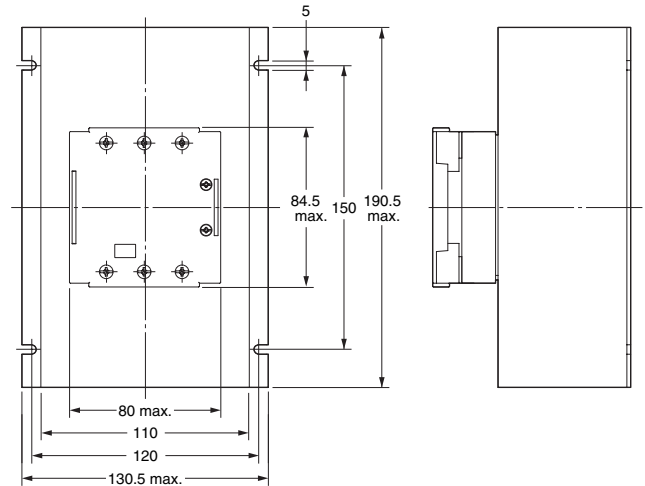

Note: With terminal cover.

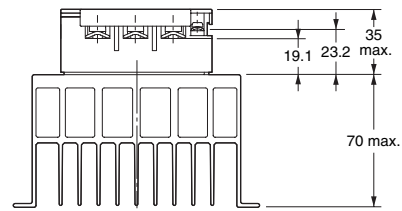
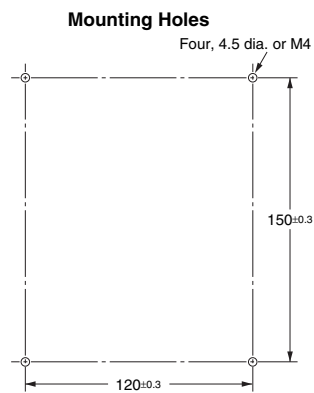

Terminal Arrangement/Internal Circuit Diagram

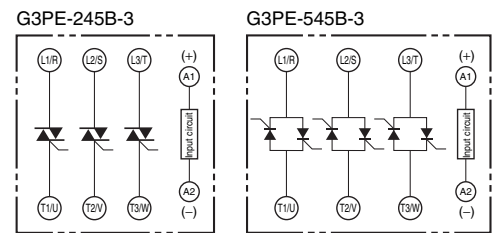

## Models with Externally Attached Heat Sinks

G3PE-215B-3H  
G3PE-215B-2H  
G3PE-225B-3H  
G3PE-225B-2H  
G3PE-235B-3H  
G3PE-235B-2H  
G3PE-245B-3H  
G3PE-245B-2H  
G3PE-515B-3H  
G3PE-515B-2H  
G3PE-525B-3H  
G3PE-525B-2H  
G3PE-535B-3H  
G3PE-535B-2H  
G3PE-545B-3H  
G3PE-545B-2H

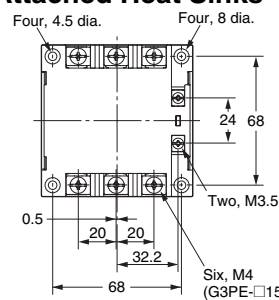

Note: Without terminal cover.

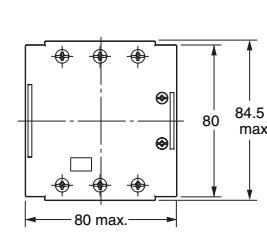

Note: With terminal cover.

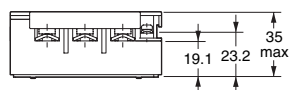
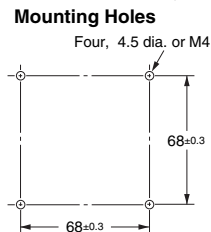
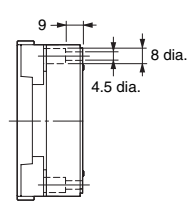

Terminal Arrangement/Internal Circuit Diagram

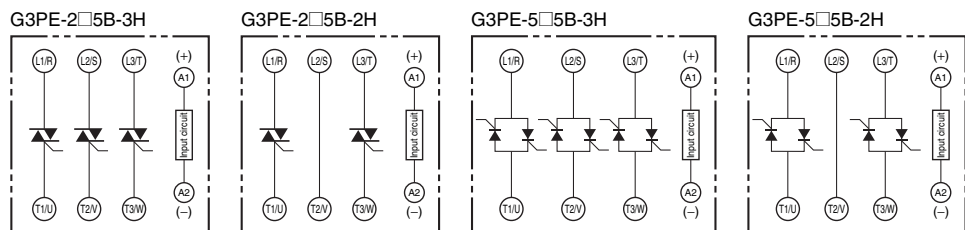

Accessories (Order Separately)

Heat Sink

Y92B-P50 (Mounts to DIN Track.)  
For G3PE-215B-2H and  
G3PE-515B-2H

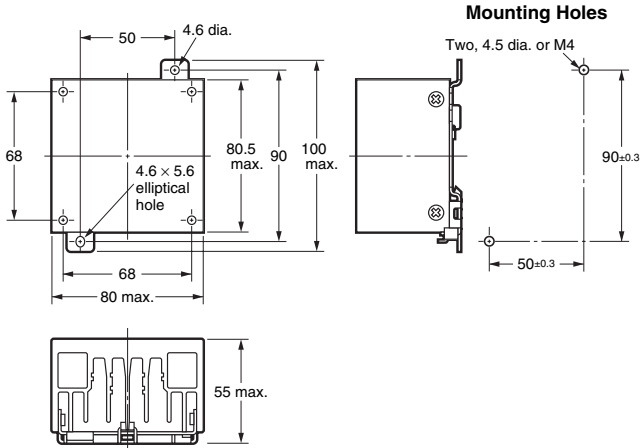

Heat Sink

Y92B-P100  
For G3PE-215B-3H,  
G3PE-225B-2H,  
G3PE-515B-3H, and  
G3PE-525B-2H

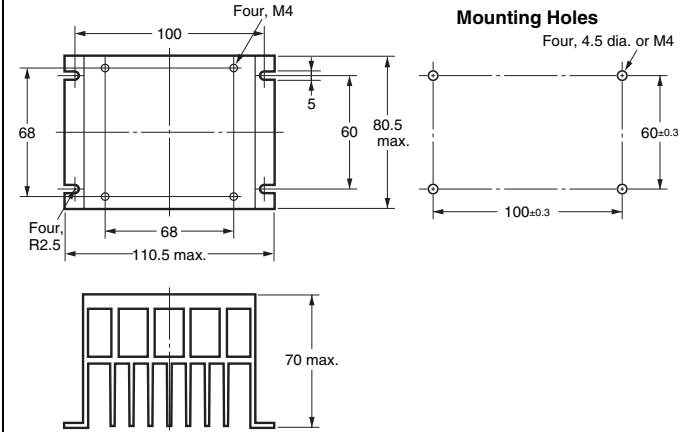

Heat Sink

Y92B-P150  
For G3PE-225B-3H,  
G3PE-235B-2H,  
G3PE-525B-3H, and  
G3PE-535B-2H

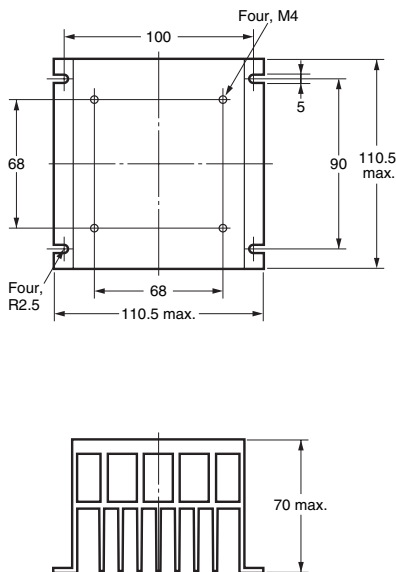

Mounting Holes

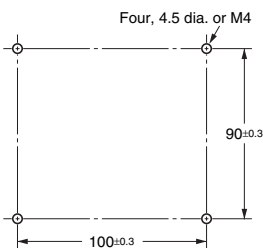

Heat Sink

Y92B-P200  
For G3PE-235B-3H,  
G3PE-245B-2H,  
G3PE-535B-3H, and  
G3PE-545B-2H

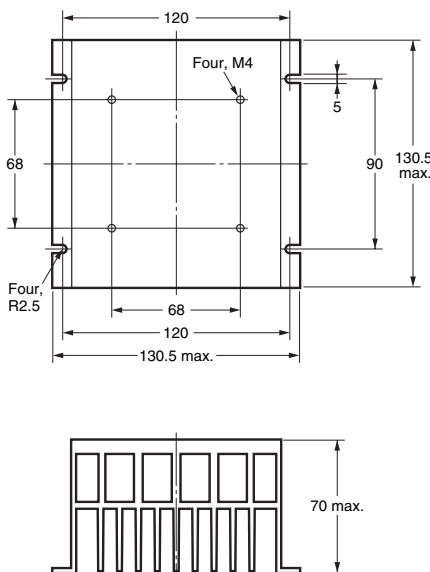

Mounting Holes

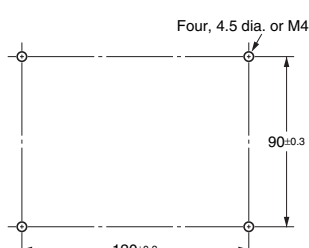

Heat Sink

Y92B-P250  
For G3PE-245B-3H and  
G3PE-545B-3H

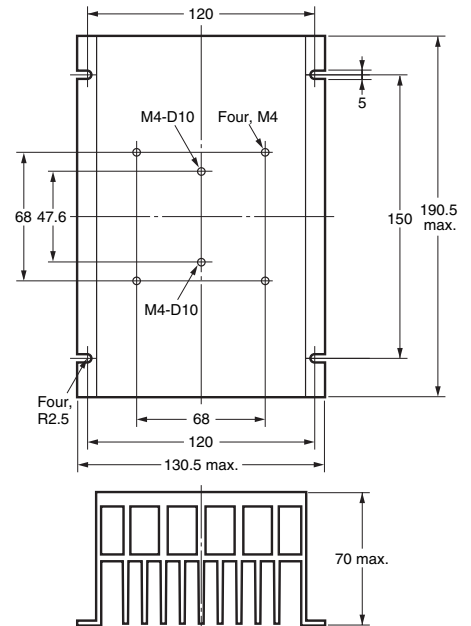

Mounting Holes

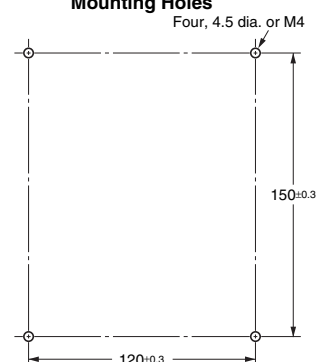

## Read and Understand This Catalog

Please read and understand this catalog before purchasing the products. Please consult your OMRON representative if you have any questions or comments.

## Warranty and Limitations of Liability

### WARRANTY

OMRON's exclusive warranty is that the products are free from defects in materials and workmanship for a period of one year (or other period if specified) from date of sale by OMRON.

OMRON MAKES NO WARRANTY OR REPRESENTATION, EXPRESS OR IMPLIED, REGARDING NON-INFRINGEMENT, MERCHANTABILITY, OR FITNESS FOR PARTICULAR PURPOSE OF THE PRODUCTS. ANY BUYER OR USER ACKNOWLEDGES THAT THE BUYER OR USER ALONE HAS DETERMINED THAT THE PRODUCTS WILL SUITABLY MEET THE REQUIREMENTS OF THEIR INTENDED USE. OMRON DISCLAIMS ALL OTHER WARRANTIES, EXPRESS OR IMPLIED.

### LIMITATIONS OF LIABILITY

OMRON SHALL NOT BE RESPONSIBLE FOR SPECIAL, INDIRECT, OR CONSEQUENTIAL DAMAGES, LOSS OF PROFITS OR COMMERCIAL LOSS IN ANY WAY CONNECTED WITH THE PRODUCTS, WHETHER SUCH CLAIM IS BASED ON CONTRACT, WARRANTY, NEGLIGENCE, OR STRICT LIABILITY.

In no event shall the responsibility of OMRON for any act exceed the individual price of the product on which liability is asserted.

IN NO EVENT SHALL OMRON BE RESPONSIBLE FOR WARRANTY, REPAIR, OR OTHER CLAIMS REGARDING THE PRODUCTS UNLESS OMRON'S ANALYSIS CONFIRMS THAT THE PRODUCTS WERE PROPERLY HANDLED, STORED, INSTALLED, AND MAINTAINED AND NOT SUBJECT TO CONTAMINATION, ABUSE, MISUSE, OR INAPPROPRIATE MODIFICATION OR REPAIR.

## Application Considerations

### SUITABILITY FOR USE

OMRON shall not be responsible for conformity with any standards, codes, or regulations that apply to the combination of products in the customer's application or use of the products.

At the customer's request, OMRON will provide applicable third party certification documents identifying ratings and limitations of use that apply to the products. This information by itself is not sufficient for a complete determination of the suitability of the products in combination with the end product, machine, system, or other application or use.

The following are some examples of applications for which particular attention must be given. This is not intended to be an exhaustive list of all possible uses of the products, nor is it intended to imply that the uses listed may be suitable for the products:

- Outdoor use, uses involving potential chemical contamination or electrical interference, or conditions or uses not described in this catalog.
- Nuclear energy control systems, combustion systems, railroad systems, aviation systems, medical equipment, amusement machines, vehicles, safety equipment, and installations subject to separate industry or government regulations.
- Systems, machines, and equipment that could present a risk to life or property.

Please know and observe all prohibitions of use applicable to the products.

NEVER USE THE PRODUCTS FOR AN APPLICATION INVOLVING SERIOUS RISK TO LIFE OR PROPERTY WITHOUT ENSURING THAT THE SYSTEM AS A WHOLE HAS BEEN DESIGNED TO ADDRESS THE RISKS, AND THAT THE OMRON PRODUCTS ARE PROPERLY RATED AND INSTALLED FOR THE INTENDED USE WITHIN THE OVERALL EQUIPMENT OR SYSTEM.

### PROGRAMMABLE PRODUCTS

OMRON shall not be responsible for the user's programming of a programmable product, or any consequence thereof.

## Disclaimers

### CHANGE IN SPECIFICATIONS

Product specifications and accessories may be changed at any time based on improvements and other reasons.

It is our practice to change model numbers when published ratings or features are changed, or when significant construction changes are made. However, some specifications of the products may be changed without any notice. When in doubt, special model numbers may be assigned to fix or establish key specifications for your application on your request. Please consult with your OMRON representative at any time to confirm actual specifications of purchased products.

### DIMENSIONS AND WEIGHTS

Dimensions and weights are nominal and are not to be used for manufacturing purposes, even when tolerances are shown.

### PERFORMANCE DATA

Performance data given in this catalog is provided as a guide for the user in determining suitability and does not constitute a warranty. It may represent the result of OMRON's test conditions, and the users must correlate it to actual application requirements. Actual performance is subject to the OMRON Warranty and Limitations of Liability.

### ERRORS AND OMISSIONS

The information in this document has been carefully checked and is believed to be accurate; however, no responsibility is assumed for clerical, typographical, or proofreading errors, or omissions.

2010.1

In the interest of product improvement, specifications are subject to change without notice.

**OMRON Corporation**  
Industrial Automation Company

<http://www.ia.omron.com/>

(c)Copyright OMRON Corporation 2010 All Right Reserved.

## X-ON Electronics

Largest Supplier of Electrical and Electronic Components

*Click to view similar products for [Solid State Relays - Industrial Mount](#) category:*

*Click to view products by [Omron](#) manufacturer:*

Other Similar products are found below :

[6225XXASRS-DC3](#) [D2440-C](#) [H10CA4890](#) [D4875C](#) [D53TP50DH-10](#) [1395831-1](#) [BR312BY](#) [A-1326](#) [AQY210SXE01](#) [AQY221N2SYD01](#)  
[AQY414SXE01](#) [26532764](#) [H10CA4850](#) [H12CA4890VL](#) [RA2410-D06](#) [RA2410-D06T](#) [D1202F](#) [D53TP50-10](#) [W230E-1-12](#) [W230T-3-12](#)  
[W6125ASX-1](#) [W6225DSX-2](#) [W6240DSX-4](#) [W6240DTX-2](#) [1-1617033-9](#) [MS2-D2420](#) [MS2-D2430](#) [A-1440](#) [RJ1P60V50E](#) [RN1F48I50](#)  
[70.362.1028.0](#) [7-1393030-8](#) [Z5.509.0828.0](#) [W230E-2-5](#) [G3RV-SR700-D AC110](#) [G3RV-SR700-D DC12](#) [G3PA-210BL-VD DC5-24](#) [G3RV-](#)  
[SR500-AL AC100](#) [G3RV-SR500-D ACDC24](#) [G3RV-SR500-AL ACDC24](#) [G3RV-SR700-D ACDC24](#) [G3RV-SR700-AL ACDC24](#) [G3RV-](#)  
[SR500-D DC12](#) [G3RV-SR700-A ACDC24](#) [G3RV-SR500-A ACDC24](#) [2912138](#) [2912141](#) [SSRDAC10](#) [1613353](#) [1613349](#)