

MOS FET Relays G3VM-353H/H1

Analog-switching MOS FET Relay with SPST-NC (Single-pole, Single-throw, Normally Closed) Contacts. General-purpose Series Added.

- New models in 350 load voltage with SPST-NC contacts and a 6-pin SOP package. General-purpose (high On-Resistance) series added.
- Continuous load current of 120 mA.
- Dielectric strength of 1,500 Vrms between I/O.
- RoHS Compliant.

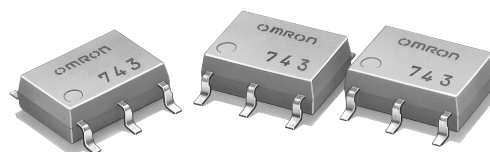

NEW

Application Examples

- Broadband systems
- Measurement devices and Data loggers
- Amusement machines

Note: The actual product is marked differently from the image shown here.

List of Models

Contact form	Terminals	Load voltage (peak value)	Model	Number per stick	Number per tape
SPST-NC	Surface-mounting terminals	350 VAC	G3VM-353H	75	---
			G3VM-353H1		
			G3VM-353H(TR)	---	2,500
			G3VM-353H1(TR)		

Dimensions

Note: All units are in millimeters unless otherwise indicated.

G3VM-353H/H1

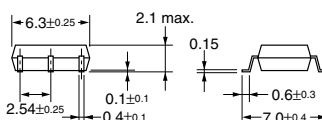
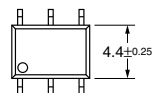
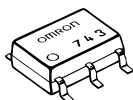

Weight: 0.13 g

Note: The actual product is marked differently from the image shown here.

Terminal Arrangement/Internal Connections (Top View)

G3VM-353H/H1

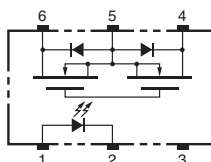

Actual Mounting Pad Dimensions (Recommended Value, Top View)

G3VM-353H/H1

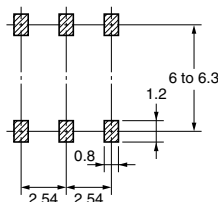

■ Absolute Maximum Ratings (Ta = 25°C)

Item		Symbol	Rating	Unit	Measurement conditions	
Input	LED forward current	I_F	50	mA		
	Repetitive peak LED forward current	I_{FP}	1	A	100 μ s pulses, 100 pps	
	LED forward current reduction rate	$\Delta I_F/^\circ\text{C}$	-0.5	mA/°C	$T_a \geq 25^\circ\text{C}$	
	LED reverse voltage	V_R	5	V		
	Connection temperature	T_j	125	°C		
Output	Load voltage (AC peak/DC)	V_{OFF}	350	V		
	Continuous load current	Connection A	I_O	120 (90)	mA	$T_a \geq 25^\circ\text{C}$
		Connection B		120 (90)		
		Connection C		240 (180)		
	ON current reduction rate	Connection A	$\Delta I_{ON}/^\circ\text{C}$	-1.2 (-0.9)	mA/°C	
Connection B			-1.2 (-0.9)			
Connection C			-2.4 (-1.8)			
Connection temperature	T_j	125	°C			
Dielectric strength between input and output (See note 1.)		V_{I-O}	1,500	V_{rms}	AC for 1 min	
Operating temperature		T_a	-40 to +85	°C	With no icing or condensation	
Storage temperature		T_{stg}	-55 to +125	°C	With no icing or condensation	
Soldering temperature (10 s)		---	260	°C	10 s	

Note: 1. The dielectric strength between the input and output was checked by applying voltage between all pins as a group on the LED side and all pins as a group on the light-receiving side.

Connection Diagram

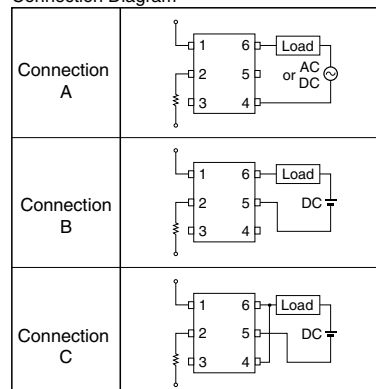

Values inside parentheses () are for G3VM-353H1

■ Electrical Characteristics (Ta = 25°C)

Item		Symbol	Minimum	Typical	Maximum	Unit	Measurement conditions	
Input	LED forward voltage	V_F	1.0	1.15	1.3	V	$I_F = 10 \text{ mA}$	
	Reverse current	I_R	---	---	10	μA	$V_R = 5 \text{ V}$	
	Capacity between terminals	C_T	---	30	---	pF	$V = 0, f = 1 \text{ MHz}$	
	Trigger LED forward current	I_{FT}	---	1.0	3.0	mA	$I_{OFF} = 10 \mu\text{A}$	
Output	Maximum resistance with output ON	Connection A	R_{ON}	---	15 (27)	25 (50)	Ω	$I_O = 120 \text{ mA}$
		Connection B		---	8 (20)	14 (43)	Ω	$I_O = 120 \text{ mA}$
		Connection C		---	4 (10)	---	Ω	$I_O = 240 \text{ mA}$
Current leakage when the relay is open		I_{LEAK}	---	0.0105 (0.003)	1.0	μA	$V_{OFF} = 350 \text{ V}, I_F = 5 \text{ mA}$	
Capacity between terminals A Connection		C_{OFF}	---	65 (30)	---	pF	$V = 0, f = 1(100) \text{ MHz}, I_F = 5 \text{ mA}$	
Capacity between I/O terminals		C_{I-O}	---	0.8	---	pF	$f = 1 \text{ MHz}, V_s = 0 \text{ V}$	
Insulation resistance		R_{I-O}	1,000	---	---	M Ω	$V_{I-O} = 500 \text{ VDC}, R_{oh} \leq 60\%$	
Turn-ON time		t_{ON}	---	0.15 (0.25)	1.0 (0.5)	ms	$I_F = 5 \text{ mA}, R_L = 200 \Omega, V_{DD} = 20 \text{ V}$ (See note 2.)	
Turn-OFF time		t_{OFF}	---	0.7 (0.5)	3.0 (1)	ms		

Note: 2. Turn-ON and Turn-OFF Times

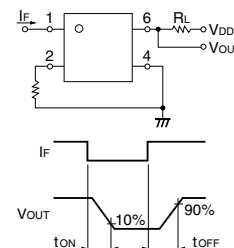

Values inside parentheses () are for G3VM-353H1

■ Recommended Operating Conditions

Use the G3VM under the following conditions so that the Relay will operate properly.

Item	Symbol	Minimum	Typical	Maximum	Unit
Load voltage (AC peak/DC)	V_{DD}	---	---	280	V
Operating LED forward current	I_F	5	---	25	mA
Continuous load current (AC peak/DC)	I_O	---	---	120 (90)	mA
Operating temperature	T_a	-20	---	65	°C

Values inside parentheses () are for G3VM-353H1

■ Engineering Data

G3VM-353H

LED forward current vs. Ambient temperature
I_F - T_a

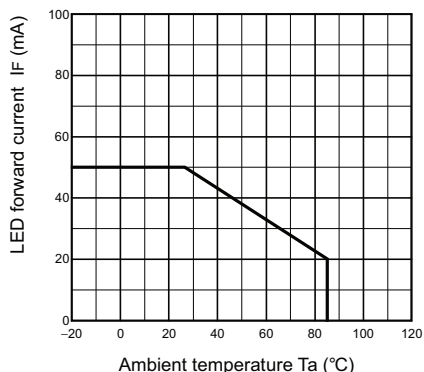

Continuous load current vs. Ambient temperature
I_O - T_a

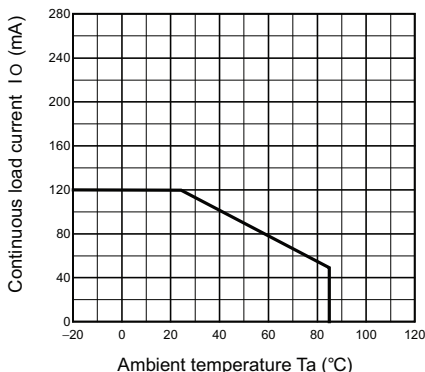

LED forward current vs. LED forward voltage
I_F - V_F

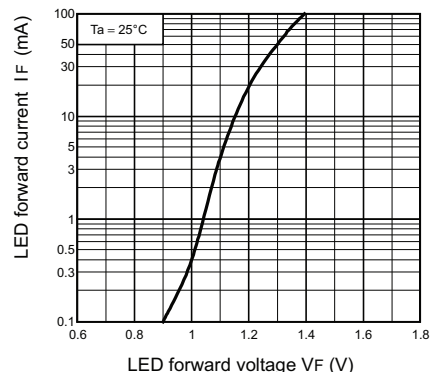

Continuous load current vs. On-state voltage
I_O - V_{ON}

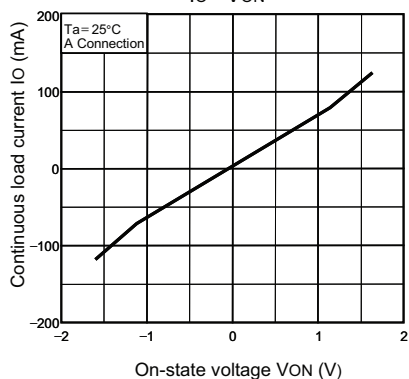

On-state resistance vs. Ambient temperature
R_{ON} - T_a

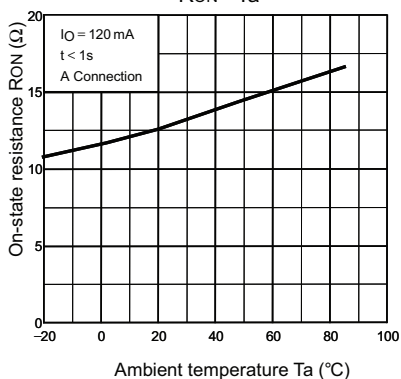

Trigger LED forward current vs. Ambient temperature
I_FC - T_a

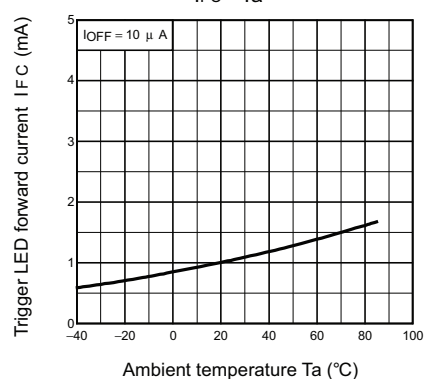

Turn ON, Turn OFF time vs. LED forward current
t_{ON}, t_{OFF} - I_F

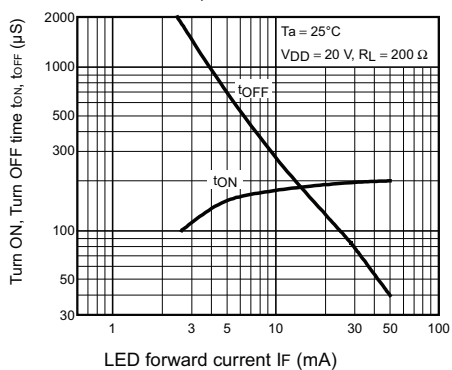

Turn ON, Turn OFF time vs. Ambient temperature
t_{ON}, t_{OFF} - T_a

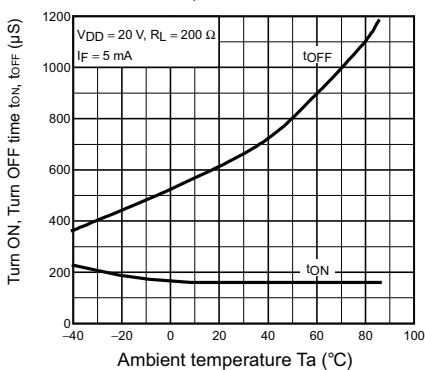

Current leakage vs. Ambient temperature
I_{LEAK} - T_a

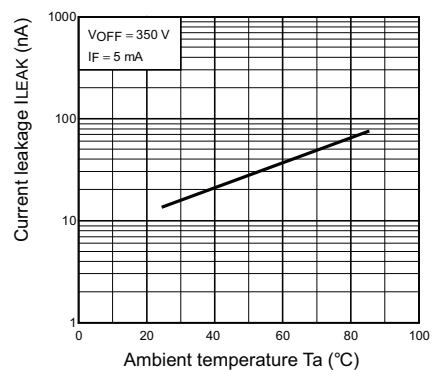

■ Engineering Data

G3VM-353H1

LED forward current vs. Ambient temperature
IF - Ta

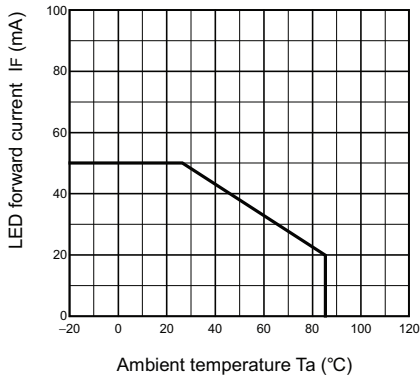

Continuous load current vs. Ambient temperature
IO - Ta

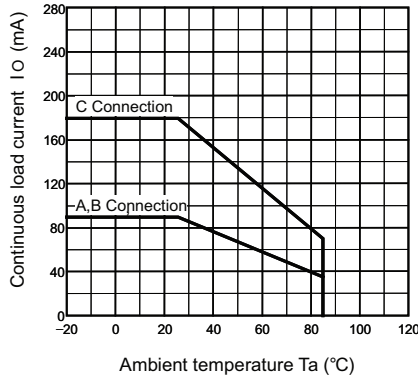

LED forward current vs. LED forward voltage
IF - VF

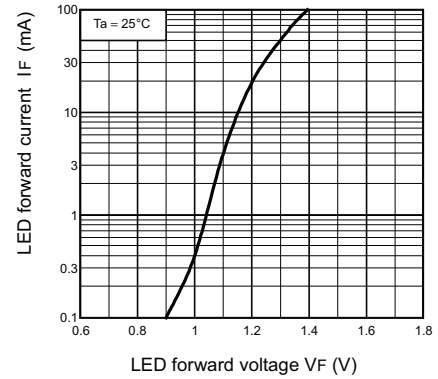

Continuous load current vs. On-state voltage
IO - VON

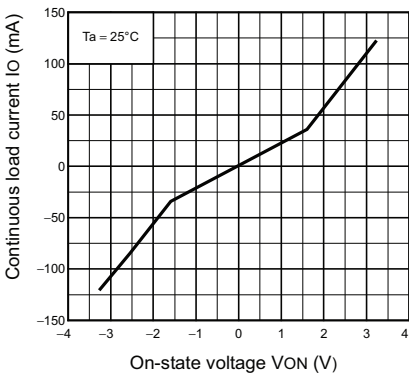

On-state resistance vs. Ambient temperature
RON - Ta

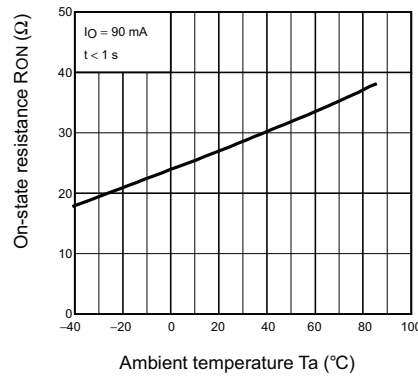

Trigger LED forward current vs. Ambient temperature
IFC - Ta

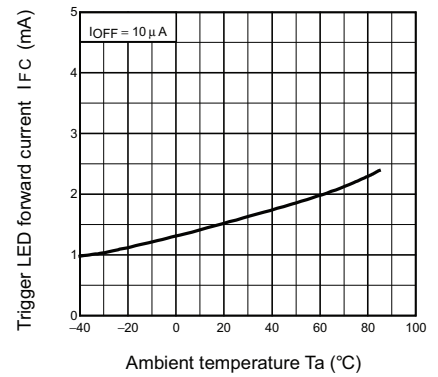

Turn ON, Turn OFF time vs. LED forward current
tON, tOFF - IF

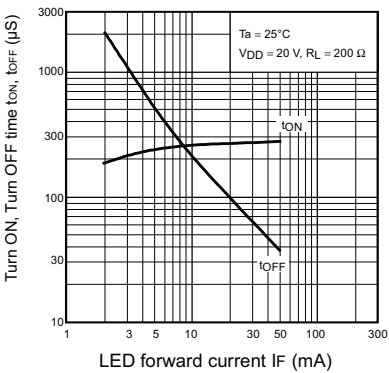

Turn ON, Turn OFF time vs. Ambient temperature
tON, tOFF - Ta

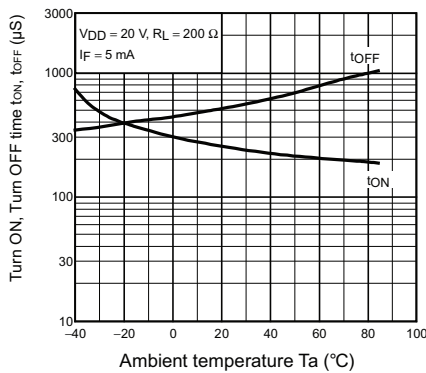

Current leakage vs. Ambient temperature
ILEAK - Ta

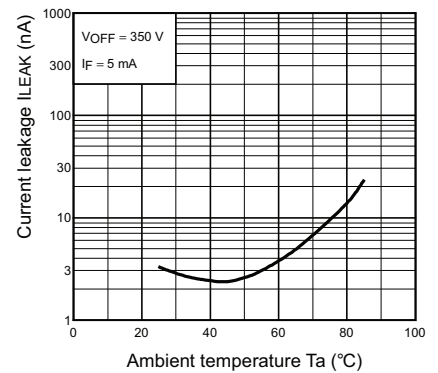

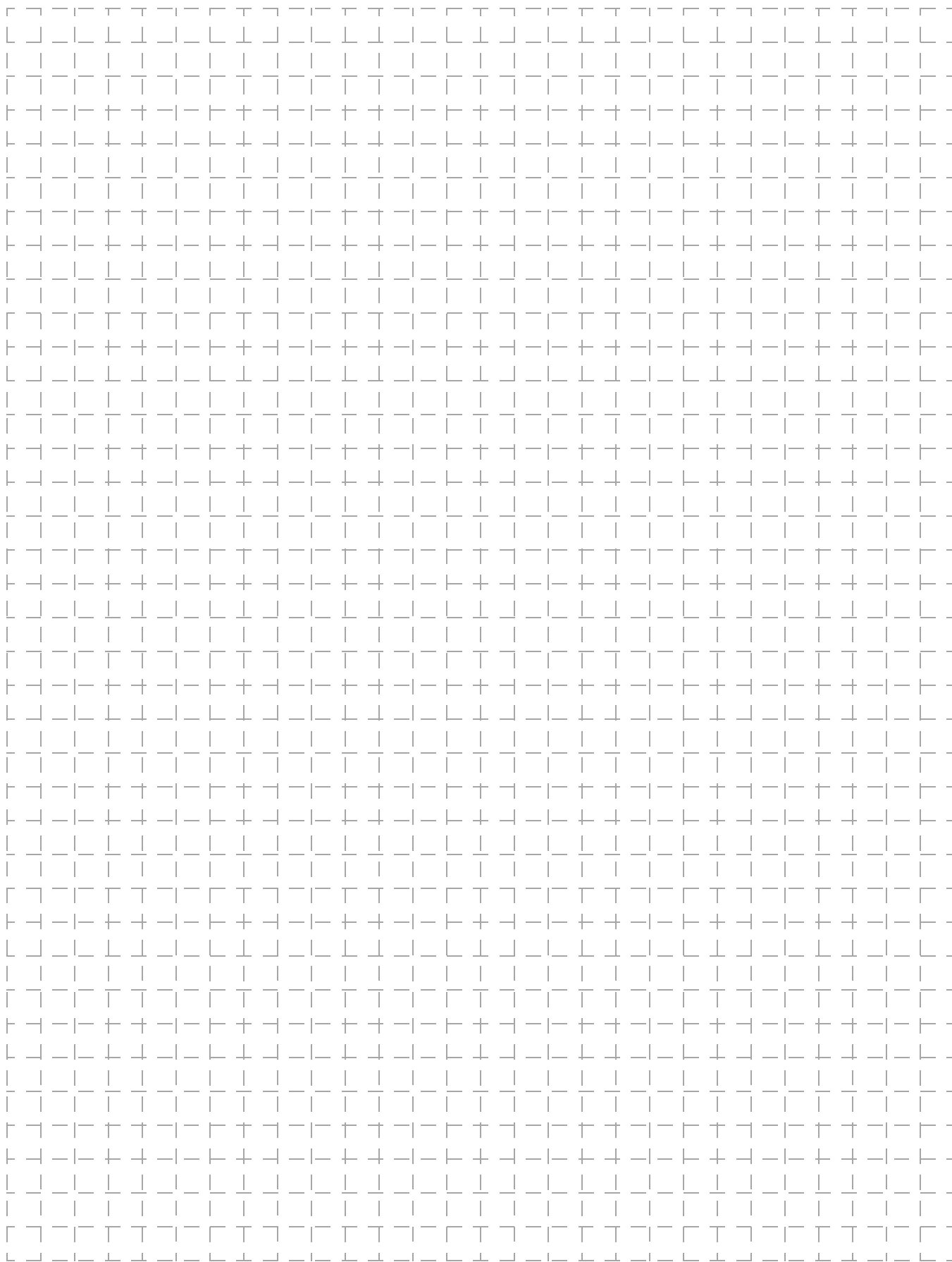

All sales are subject to Omron Electronic Components LLC standard terms and conditions of sale, which can be found at http://www.components.omron.com/components/web/webfiles.nsf/sales_terms.html

ALL DIMENSIONS SHOWN ARE IN MILLIMETERS.
To convert millimeters into inches, multiply by 0.03937. To convert grams into ounces, multiply by 0.03527.

OMRON[®]

**OMRON ELECTRONIC
COMPONENTS LLC**

55 E. Commerce Drive, Suite B
Schaumburg, IL 60173

847-882-2288

OMRON ON-LINE

Global - <http://www.omron.com>

USA - <http://www.components.omron.com>

Cat. No. X302-E-1

12/10

Specifications subject to change without notice

Printed in USA

X-ON Electronics

Largest Supplier of Electrical and Electronic Components

Click to view similar products for [Solid State Relays - PCB Mount](#) category:

Click to view products by [Omron](#) manufacturer:

Other Similar products are found below :

[M86F-2W](#) [M90F-2W](#) [G2-1A07-ST](#) [G2-1A07-TT](#) [G2-1B02-TT](#) [G2-DA06-ST](#) [G3CN-202PL-3-US DC12](#) [G3CN-203P DC3-28](#)
[G3RDX02SNUSDC12](#) [PLA134S](#) [DMP6202A](#) [DS11-1005](#) [AQ3A2-ZT432VDC](#) [AQV212J](#) [AQV214SD02](#) [AQV252GAJ](#) [AQW414EA](#)
[AQY221R2SJ](#) [EFR1200480A150](#) [LCA220](#) [LCB110S](#) [1618400-5](#) [SR75-1ST](#) [AQV212AJ](#) [AQV238AD01](#) [AQV252GAXJ](#) [AQW414TS](#)
[AQY210SXT](#) [AQY212ST](#) [AQY221N2V1YJ](#) [AQY275AXJ](#) [G2-1A02-ST](#) [G2-1A02-TT](#) [G2-1A03-ST](#) [G2-1A03-TT](#) [G2-1A05-ST](#) [G2-1A06-](#)
[TT](#) [G2-1A23-TT](#) [G2-1B01-ST](#) [G2-1B01-TT](#) [G2-1B02-ST](#) [G2-DA03-ST](#) [G2-DA03-TT](#) [G2-DA06-TT](#) [G3M-203PL-UTU-1 DC24](#)
[CPC2330N](#) [3-1617776-2](#) [CTA2425](#) [TS190](#) [LBB110S](#)