

# MOS FET Relays G3VM-41LR10

**SSOP Package MOS FET Relays with Low Leakage Current, Output Capacitance and ON Resistance ( $C \times R = 5.4 \text{ pF} \cdot \Omega$ ) in a 40-V Load Voltage Model.**

- Output capacitance of 0.45 pF (typical) allows high frequency applications.
- Leakage current of 0.2 nA max. (10 pA typ.) when relay is open
- Turn-on time = 0.026 ms (typ.)
- RoHS compliant

**Application Examples**

- Semiconductor inspection tools
- Measurement devices and Data loggers
- Broadband systems



**NEW**

**Note:** The actual product is marked differently from the image shown here.

**List of Models**

Contact form	Terminals	Load voltage (peak value)	Model	Number per tape
SPST-NO	Surface-mounting terminals	40 VAC	G3VM-41LR10	---
			G3VM-41LR10(TR05)	500
			G3VM-41LR10(TR)	1,500

**Dimensions**

**Note:** All units are in millimeters unless otherwise indicated.

G3VM-41LR10

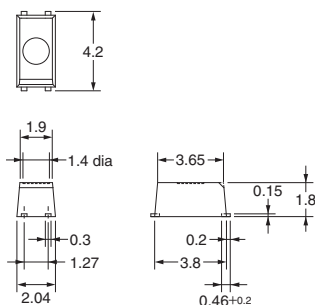
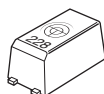

**Note:** A tolerance of  $\pm 0.1 \text{ mm}$  applies to all dimensions unless otherwise specified.

Weight: 0.03 g

**Note:** The actual product is marked differently from the image shown here.

**Terminal Arrangement/Internal Connections (Top View)**

G3VM-41LR10

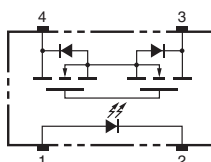

**Actual Mounting Pad Dimensions (Recommended Value, Top View)**

G3VM-41LR10

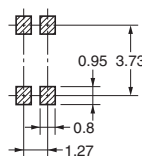

■ Absolute Maximum Ratings (Ta = 25°C)

Item	Symbol	Rating	Unit	Measurement Conditions	
Input	LED forward current	$I_F$	30	mA	
	LED forward current reduction rate	$\Delta I_F/^\circ\text{C}$	-0.3	mA/°C	$T_a \geq 25^\circ\text{C}$
	LED reverse voltage	$V_R$	5	V	
	Connection temperature	$T_j$	125	°C	
Output	Load voltage (AC peak/DC)	$V_{OFF}$	40	V	
	Continuous load current	$I_O$	120	mA	
	ON current reduction rate	$\Delta I_{ON}/^\circ\text{C}$	-1.2	mA/°C	$T_a \geq 25^\circ\text{C}$
	Connection temperature	$T_j$	125	°C	
Dielectric strength between input and output (See note 1.)		$V_{I-O}$	1,500	$V_{rms}$	AC for 1 min
Ambient operating temperature		$T_a$	-20 to +85	°C	With no icing or condensation
Storage temperature		$T_{stg}$	-40 to +125	°C	With no icing or condensation
Soldering temperature		---	260	°C	10 s

**Note:** 1. The dielectric strength between the input and output was checked by applying voltage between all pins as a group on the LED side and all pins as a group on the light-receiving side.

■ Electrical Characteristics (Ta = 25°C)

Item	Symbol	Minimum	Typical	Maximum	Unit	Measurement conditions	
Input	LED forward voltage	$V_F$	1.15	1.35	1.45	V	$I_F = 5 \text{ mA}$
	Reverse current	$I_R$	---	---	10	$\mu\text{A}$	$V_R = 5 \text{ V}$
	Capacity between terminals	$C_T$	---	70	---	pF	$V = 0, f = 1 \text{ MHz}$
	Trigger LED forward current	$I_{FT}$	---	---	3	mA	$I_O = 100 \text{ mA}$
Output	Maximum resistance with output ON	$R_{ON}$	---	12	14	$\Omega$	$I_F = 5 \text{ mA}, I_O = 120 \text{ mA}, t < 1 \text{ s}$
	Current leakage when the relay is open	$I_{LEAK}$	---	10	200	pA	$V_{OFF} = 35 \text{ V}, T_a = 25^\circ\text{C}$
	Capacity between terminals	$C_{OFF}$	---	0.45	0.8	pF	$V = 0, f = 100 \text{ MHz}, t < 1 \text{ s}$
Capacity between I/O terminals		$C_{I-O}$	---	0.3	---	pF	$f = 1 \text{ MHz}, V_s = 0 \text{ V}$
Insulation resistance between I/O terminals		$R_{I-O}$	1,000	---	---	M $\Omega$	$V_{I-O} = 500 \text{ VDC}, R_{OH} \leq 60\%$
Turn-ON time		$t_{ON}$	---	0.026	0.2	ms	$I_F = 5 \text{ mA}, R_L = 200 \Omega, V_{DD} = 10 \text{ V}$ (See note 2.)
Turn-OFF time		$t_{OFF}$	---	0.14	0.3	ms	

**Note:** 2. Turn-ON and Turn-OFF Times

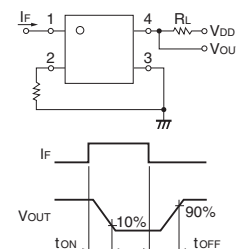

■ Recommended Operating Conditions

Use the G3VM under the following conditions so that the Relay will operate properly.

Item	Symbol	Minimum	Typical	Maximum	Unit
Load voltage (AC peak/DC)	$V_{DD}$	---	---	32	V
Operating LED forward current	$I_F$	---	---	20	mA
Continuous load current (AC peak/DC)	$I_O$	---	---	120	mA
Operating temperature	$T_a$	25	---	60	°C

■ Engineering Data

LED forward current vs. Ambient temperature

$I_F - T_a$

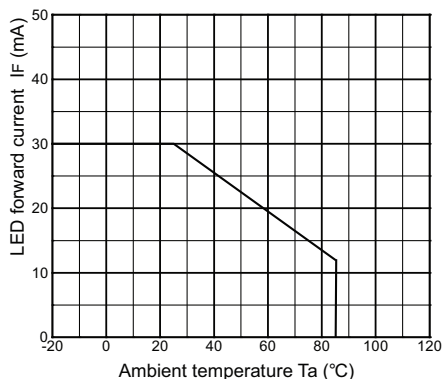

Continuous load current vs. Ambient temperature

$I_O - T_a$

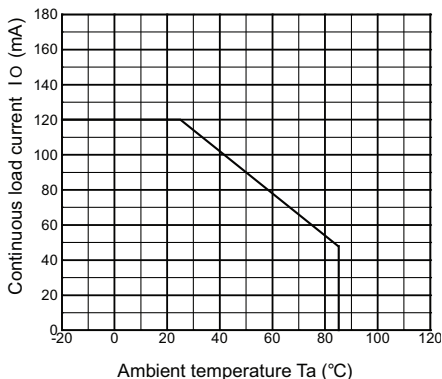

LED forward current vs. LED forward voltage

$I_F - V_F$

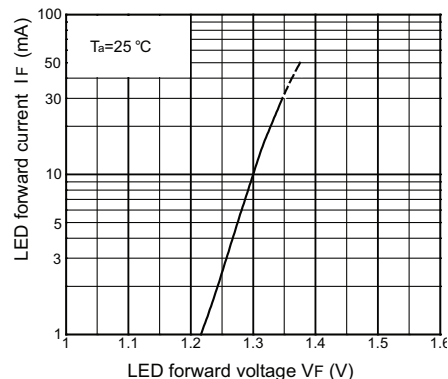

Continuous load current vs. On-state voltage

$I_O - V_{ON}$

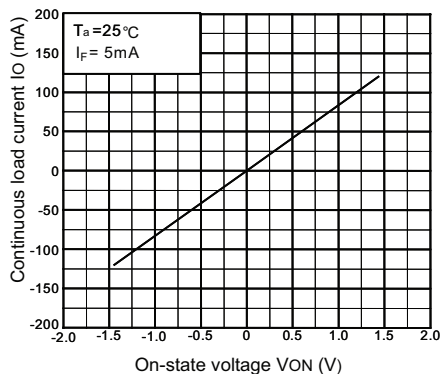

On-state resistance vs. Ambient temperature

$R_{ON} - T_a$

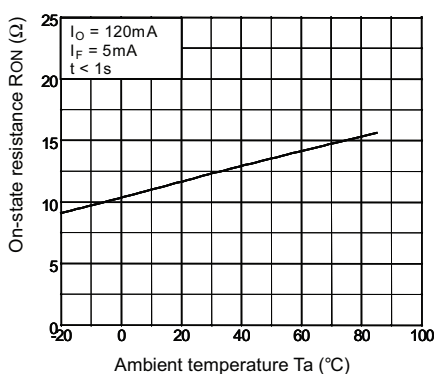

Trigger LED forward current vs. Ambient temperature

$I_{FT} - T_a$

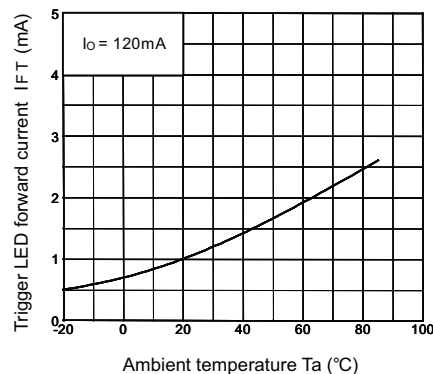

Turn ON, Turn OFF time vs. LED forward current

$t_{ON}, t_{OFF} - I_F$

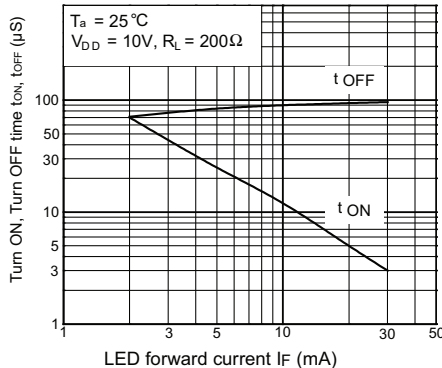

Turn ON, Turn OFF time vs. Ambient temperature

$t_{ON}, t_{OFF} - T_a$

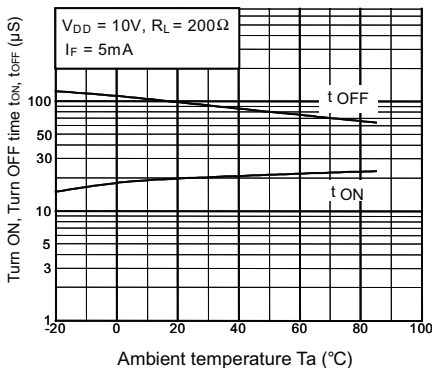

Current leakage vs. Ambient temperature

$I_{LEAK} - T_a$

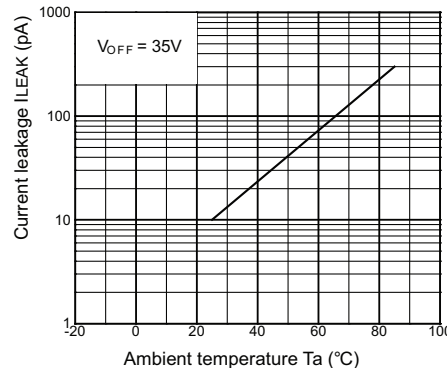

All sales are subject to Omron Electronic Components LLC standard terms and conditions of sale, which can be found at [http://www.components.omron.com/components/web/webfiles.nsf/sales\\_terms.html](http://www.components.omron.com/components/web/webfiles.nsf/sales_terms.html)

**ALL DIMENSIONS SHOWN ARE IN MILLIMETERS.**  
To convert millimeters into inches, multiply by 0.03937. To convert grams into ounces, multiply by 0.03527.

---

**OMRON**<sup>®</sup>

**OMRON ELECTRONIC  
COMPONENTS LLC**

55 E. Commerce Drive, Suite B  
Schaumburg, IL 60173

**847-882-2288**

**OMRON ON-LINE**

Global - <http://www.omron.com>

USA - <http://www.components.omron.com>

Cat. No. X302-E-1

12/10

Specifications subject to change without notice

Printed in USA

## X-ON Electronics

Largest Supplier of Electrical and Electronic Components

*Click to view similar products for [Solid State Relays - PCB Mount](#) category:*

*Click to view products by [Omron](#) manufacturer:*

Other Similar products are found below :

[M86F-2W](#) [M90F-2W](#) [G2-1A07-ST](#) [G2-1A07-TT](#) [G2-1B02-TT](#) [G2-DA06-ST](#) [G3CN-202PL-3-US DC12](#) [G3CN-203P DC3-28](#)  
[G3RDX02SNUSDC12](#) [PLA134S](#) [DMP6202A](#) [DS11-1005](#) [AQ3A2-ZT432VDC](#) [AQV212J](#) [AQV214SD02](#) [AQV252GAJ](#) [AQW414EA](#)  
[AQY221R2SJ](#) [EFR1200480A150](#) [LCA220](#) [LCB110S](#) [1618400-5](#) [SR75-1ST](#) [AQV212AJ](#) [AQV238AD01](#) [AQV252GAXJ](#) [AQW414TS](#)  
[AQY210SXT](#) [AQY212ST](#) [AQY221N2V1YJ](#) [AQY275AXJ](#) [G2-1A02-ST](#) [G2-1A02-TT](#) [G2-1A03-ST](#) [G2-1A03-TT](#) [G2-1A05-ST](#) [G2-1A06-](#)  
[TT](#) [G2-1A23-TT](#) [G2-1B01-ST](#) [G2-1B01-TT](#) [G2-1B02-ST](#) [G2-DA03-ST](#) [G2-DA03-TT](#) [G2-DA06-TT](#) [G3M-203PL-UTU-1 DC24](#)  
[CPC2330N](#) [3-1617776-2](#) [CTA2425](#) [TS190](#) [LBB110S](#)