

Power supply CP-E 12/10.0

Primary switch mode power supply

Data sheet

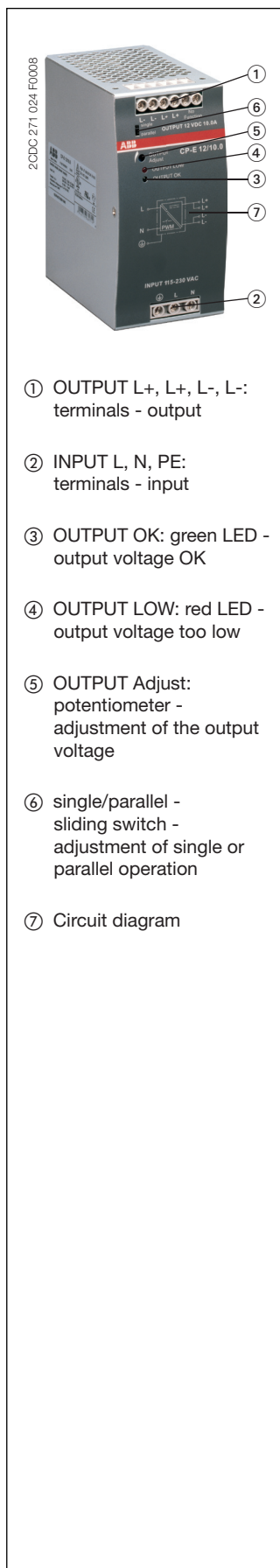

- ① OUTPUT L+, L+, L-, L-: terminals - output
- ② INPUT L, N, PE: terminals - input
- ③ OUTPUT OK: green LED - output voltage OK
- ④ OUTPUT LOW: red LED - output voltage too low
- ⑤ OUTPUT Adjust: potentiometer - adjustment of the output voltage
- ⑥ single/parallel - sliding switch - adjustment of single or parallel operation
- ⑦ Circuit diagram

Features

- Rated output voltage 12 V DC
- Output voltage adjustable via front-face rotary potentiometer “OUTPUT Adjust”
- Rated output current 10 A
- Rated output power 120 W
- Supply range 115/230 V AC (90-132 V AC, 180-264 V AC, 210-375 V DC), auto select
- Typical efficiency of 84 %
- Low power dissipation and low heating
- Free convection cooling (no forced cooling with ventilators)
- Ambient temperature range during operation -35...+70 °C
- Open-circuit, overload and short-circuit stable
- Integrated input fuse
- Redundancy unit CP-A RU offering true redundancy, available as accessory
- LEDs for status indication

Approvals

<ul style="list-style-type: none"> UL 508, CAN/CSA C22.2 No.14 ANSI/ISA-12.12 (Class I, Div. 2, hazardous locations) UL 60950, CAN/CSA C22.2 No.60950 GOST CCC 	<p>Approval refers to rated input voltage U_{in}</p> <p>Approval refers to rated input voltage U_{in}</p> <p>Approval refers to rated input voltage U_{in}</p>
--	---

Marks

- CE CE
- C-Tick C-Tick

Order data

Type	Input voltage range	Rated output voltage / current	Order code
CP-E 12/10.0	90-132 V AC / 180-264 V AC 210-375 V DC	12 V DC / 10 A	1SVR 427 035 R1000

Order data - Accessories

Type	Description	Order code
CP-A RU	Redundancy unit The CP-A RU provides decoupling of two CP-E power supply units ≤ 40 V and ≥ 5 A.	1SVR 427 071 R0000

Application

The primary switch mode power supply offers two voltage input ranges. This enables the supply with AC or DC. Furthermore it is equipped with two generous capacitors, which ensure mains buffering of at least 30 ms (at 230 V AC). That is why the devices can be used worldwide also in high fluctuating networks and battery-powered plants.

Power supply CP-E 12/10.0

Primary switch mode power supply

Data sheet

Operating mode

By means of the potentiometer „OUTPUT Adjust“ the output voltage can be adjusted within a range of 11.4 to 14.5 V DC. Thus, the power supply can be optimally adapted to the application, e.g. compensating the voltage drop caused by a long line length.

The green LED „OUTPUT OK“ is lightening during proper operation.

The red LED „OUTPUT LOW“ is lightening when the output voltage is too low.

Switch „single/parallel“ for selection of single or parallel operation.

Installation

Mounting

The switch mode power supply can be snapped on a DIN rail according to IEC/EN 60715 as shown in the accompanying picture. For that the device is set with its mounting rail slide on the upper edge of the mounting rail and locked by lifting it downwards.

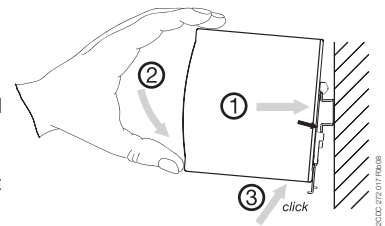

Demounting

Remove the switch mode power supply as shown in the accompanying picture. For that the latching lever is pulled downwards by means of the screwdriver. Alternatively you can press the unlock button to release the device. Then in both cases the device can be unhinged from the mounting rail edge and removed.

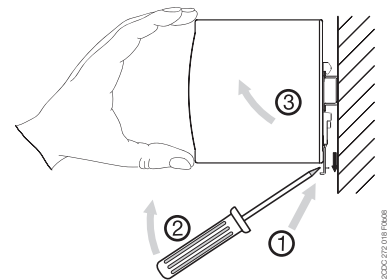

Mounting position

The devices have to be mounted horizontally with the input terminals on the bottom. In order to ensure a sufficient convection, the minimum distance to other modules should not be less than 25 mm in vertical and horizontal direction.

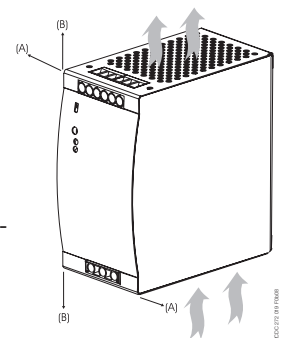

Electrical connection

Connect the input terminals L and N. The protective earth conductor PE must be connected. The installation must be executed acc. to EN 60950, provide a suitable disconnecting device (e. g. line protection switch) in the supply line. The input side is protected by an internal input fuse.

Rate the lines for the maximum output current (considering the short-circuit current) or provide a separate fuse protection. We recommend to choose the cable section as large as possible in order to minimize voltage drops. Observe the polarity. The device is overload, short-circuit and open-circuit proof. The secondary side of the power supply unit is electrically isolated from the input and internally not earthed (SELV) and can therefore be earthed by the user according to the needs with L+ or L- (PELV).

Power supply CP-E 12/10.0

Primary switch mode power supply

Data sheet

Connection diagram

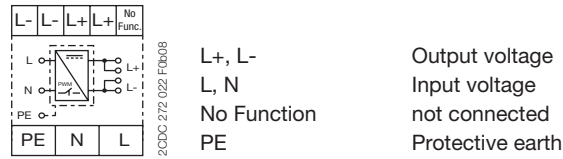

Safety instructions and warnings

The device must be installed by qualified persons only and in accordance with the specific national regulations (e.g., VDE, etc.). The devices are maintenance-free chassis-mounted units.

Disconnect system from supply network!

Before any installation, maintenance or modification work: Disconnect the system from the supply network and protect against switching on.

Before start of operation:

Attention! Improper installation/operation may impair safety and cause operational difficulties or destruction of the unit. Before operation the following must be ensured:

- Connect to main according to the specific national regulations.
- Power supply cables and unit must be sufficiently fused. A disconnecting device has to be provided for the power supply to disengage unit and supply cables from supply mains if required.
- The protective earth conductor must be connected to the terminal PE (Protection class I)
- The secondary side of the power supply unit is not earthed and can be earthed by the user according to the needs with L+ or L-.
- Rate the output lines for the output current of the power supply and connect them with the correct polarity.
- In order to ensure sufficient air-cooling the distance to other devices has to be considered.

In operation:

- Do not modify the installation (primary and secondary side)! High current! Risk of electric arcs and electric shocks (danger to life)!
- Risk of burns: Depending on the operation conditions the enclosure can become very hot.
- The internal fuse is not user-replaceable. If the internal fuse blows, most probably the device is defective. In this case, an examination of the switch mode power supply by the manufacturer is necessary.

Attention! High voltage! Danger to life!



The power supplies contain components with high stored energy and circuits with high voltage! Do not introduce any objects into the unit, and do not open the unit. With some units of this range the output is capable of providing hazardous energy. Ensure that the service personnel is protected against inadvertent contact with parts carrying energy.

Power supply CP-E 12/10.0

Primary switch mode power supply

Data sheet

Technical data

Data at $T_a = 25\text{ °C}$, $U_{in} = 230\text{ V AC}$ and rated values, unless otherwise indicated

Type		CP-E 12/10.0
Input circuit		L, N
Rated input voltage U_{in}		115 / 230 V AC auto select
Input voltage range		90-132 V AC, 180-264 V AC / 210-375 V DC
Frequency range AC		47-63 Hz
Typical current consumption	at 115 V AC	2.2 A
	at 230 V AC	0.83 A
Typical power consumption		143 W
Inrush current limiting	at 115 V AC	24 A (max. 5 ms)
	at 230 V AC	48 A (max. 5 ms)
Discharge current	input / output	0.25 mA
	input / PE	3.5 mA
Power failure buffering time	at 115 V AC	min. 25 ms
	at 230 V AC	min. 30 ms
Internal input fuse		3.15 A slow-acting / 250 V AC
Power factor correction (PFC)		yes, passive, 0.7
Indication of operational states		
Output voltage	OUTPUT OK: green LED	┌───┐: output voltage OK
	OUTPUT LOW: red LED	┌───┐: output voltage too low
Output circuit		L+, L+, L-, L-
Rated output voltage		12 V DC
Tolerance of the output voltage		0...+1 %
Adjustment range of the output voltage		11.4-14.5 V DC
Rated output power		120 W
Rated output current I_r	$T_a \leq 60\text{ °C}$	10 A
Derating of the output current	$60\text{ °C} < T_a \leq 70\text{ °C}$	2.5 %/°C
Maximum deviation with	load change statical	$\pm 1\%$ (single mode) $\pm 5\%$ (parallel mode)
	change of output voltage within the input voltage range	$\pm 0.5\%$
Control time		< 2 ms
Starting time after applying the supply voltage	at I_r	max. 1 s
	with 7000 μF	max. 1.5 s
Rise time	at I_r	max. 150 ms
	with 7000 μF	max. 500 ms
Fall time		max. 150 ms
Residual ripple and switching peaks	BW = 20 MHz	50 mV
Parallel connection		configurable, to increase power, up to 3 devices, min. 0.1 I_r - max. 0.9 I_r
Series connection		yes, to increase voltage, max. 2 devices
Resistance to reverse feed		max. 18 V DC
Output circuit - No-load, overload and short-circuit behaviour		
Characteristic curve of output		U/I characteristic curve
Short-circuit protection		continuous short-circuit proof
Short-circuit behaviour		continuation with output power limiting

Power supply CP-E 12/10.0

Primary switch mode power supply

Data sheet

Type		CP-E 12/10.0
Overload protection		output power limiting
No-load protection		continuous no-load stability
Starting of capacitive loads		7000 µF
General data		
Power dissipation		typ. 24 W
Efficiency		typ. 84 %
Duty time		100 %
Dimensions (W x H x D)		63.2 x 123.6 x 123.6 mm (2.49 x 4.87 x 4.87 in)
Weight		0.888 kg (1.958 lb)
Material of housing		metal
Mounting		DIN rail (IEC/EN 60715), snap-on mounting without any tool
Mounting position		horizontal
Minimum distance to other units	horizontal / vertical	25 mm / 25 mm (0.98 in / 0.98 in)
Degree of protection	housing / terminals	IP20 / IP20
Protection class		I
Electrical connection - input circuit / output circuit		
Wire size	fine-strand with wire end ferrule	0.2-4 mm ² (24-11 AWG)
	fine-strand without wire end ferrule	0.2-6 mm ² (24-10 AWG)
	rigid	
Stripping length		8 mm (0.31 in)
Tightening torque	input / output	1.0 Nm (9 lb.in) / 0.62 Nm (5.5 lb.in)
Environmental data		
Ambient temperature range	operation	-35...+70 °C
	rated load	-35...+60 °C
	storage	-40...+85 °C
Damp heat		95 % RH, without condensation
Vibration (sinusoidal) (IEC/EN 60068-2-6)		10-500 Hz, 2 G, along X, Y, Z each axis, 60 min. for each axis
Shock (half-sine) (IEC/EN 60068-2-27)		15 G, 11 ms, 3 axis, 6 faces, 3 times for each face
Isolation data		
Rated insulation voltage U _i	input / output	3 kV AC
	input / PE	1.5 kV AC
Pollution degree		2
Overvoltage category (UL/IEC/EN 60950-1)		II
Standards		
Product standard		EN 61204-3
Low Voltage Directive		2006/95/EC
EMC directive		2004/108/EC
RoHS directive		2002/95/EC
Electrical safety		EN 60950-1, UL 60950-1, UL 508, EN 61558-1, EN 61558-2-17, EN 60204-1
Protective low voltage		SELV (EN 60950)
Electromagnetic compatibility		
Interference immunity to		IEC/EN 61000-6-2
electrostatic discharge	IEC/EN 61000-4-2	Level 4 (air discharge 15 kV / contact discharge 8 kV)
radiated, radio-frequency, electro-magnetic field	IEC/EN 61000-4-3	Level 3 (10 V/m)
electrical fast transient / burst	IEC/EN 61000-4-4	Level 4 (4 kV / 5 kHz)
surge	IEC/EN 61000-4-5	L-L Level 3 (2 kV) / L-PE Level 4 (4 kV)

Power supply CP-E 12/10.0

Primary switch mode power supply

Data sheet

Type	CP-E 12/10.0	
conducted disturbances, induced by radio-frequency fields	IEC/EN 61000-4-6	Level 3 (10 V)
power frequency magnetic fields	IEC/EN 61000-4-8	Level 4 (30 A/m)
voltage dips, short interruptions and voltage variations	IEC/EN 61000-4-11	dip: >95 % 10 ms / >30 % 500 ms interruptions: >95 % 5000 ms
Interference emission	IEC/EN 61000-6-3	
high-frequency radiated	IEC/CISPR 22, EN 55022	Class B
high-frequency conducted	IEC/CISPR 22, EN 55022	Class B
limits for harmonic current emissions	IEC/EN 61000-3-2	Class D

Technical diagrams

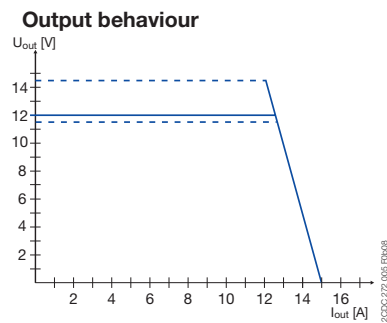

Characteristic curve of output at $T_a = 25\text{ °C}$

The switch mode power supply CP-E 12/10.0 is able to supply at 12 V DC output voltage and

- at an ambient temperature of:
 $\leq 60\text{ °C}$ a continuous output current of approx. 10 A
- at ambient temperatures of:
 $60\text{ °C} < T_a \leq 70\text{ °C}$ the output power has to be reduced by 2.5 % per °C temperature increase.

If the switch mode power supply is loaded with an output current $> 10\text{ A}$, the operating point is passing through the U/I characteristic curve shown.

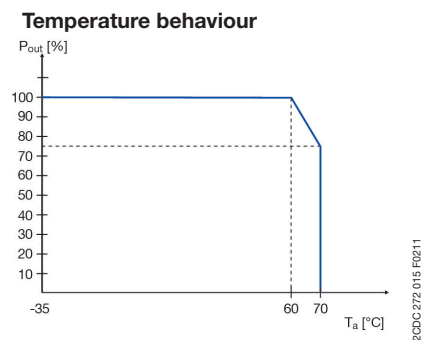

Characteristic curve of temperature at rated load

Power supply CP-E 12/10.0

Primary switch mode power supply

Data sheet

Dimensions

in mm

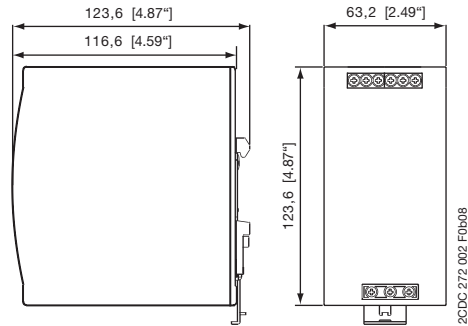

CP-E 12/10.0

Dimensions accessories

in mm

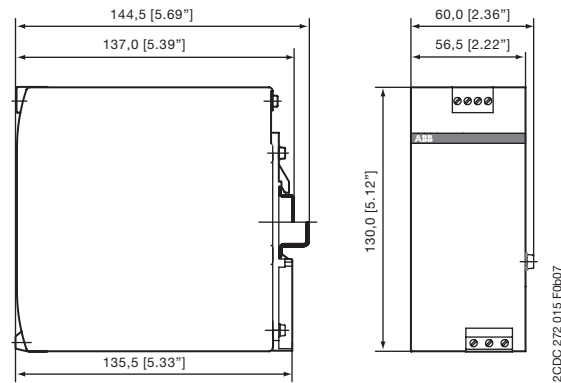

CP-A RU

Further Documentation

Document title	Document type	Document number
Electronic Products and Relays	Technical catalogue	2CDC 110 004 C020x
Power Supply Units	Application manual	2CDC 114 048 M020x
Redundancy unit CP-A RU	Data sheet	2CDC 114 036 D0202

You can find the documentation on the internet at www.abb.com/lowvoltage → Control Products → Power Supplies



As part of the on-going product improvement, ABB reserves the right to modify the characteristics of the products described in this document. The information given is non-contractual.

For further details please contact (www.abb.com/contacts) the ABB company marketing these products in your country.

Document number: 2CDC 114 059 D0201 (09/2011)

ABB STOTZ-KONTAKT GmbH

Eppelheimer Strasse 82, 69123 Heidelberg, Germany
Postfach 10 16 80, 69006 Heidelberg, Germany
Internet <http://www.abb.com/lowvoltage> → Control Products

Contact: <http://www.abb.com/contacts> → Low Voltage Products and Systems

X-ON Electronics

Largest Supplier of Electrical and Electronic Components

Click to view similar products for [abb](#) manufacturer:

Other Similar products are found below :

[TV10-516R](#) [017667013](#) [RF727](#) [2CMA100178R1000](#) [5SDD 92Z0401](#) [ESV14-BS](#) [EZS-21-250](#) [F204AC-40/0.03](#) [F204AC-40/0.1](#) [F362-25/0.03](#) [GJL1211001R0011](#) [GJL1211201R8000](#) [GJL1211501R8000](#) [GJL1213001R0017](#) [GJL1213001R0101](#) [GJL1311001R0101](#) [GJL1311001R8010](#) [GJL1311201R0001](#) [GJL1313001R0011](#) [GJL1313001R0101](#) [GJL1317201R0001](#) [AF09-30-01-11](#) [AF460-30-11-68](#) [1455](#) [EF45-30](#) [ERG297](#) [HSC2-20](#) [1SAM201904R1001](#) [1SAM350000R1003](#) [1SAZ721201R1009](#) [1SAZ721201R1014](#) [1SAZ721201R1025](#) [1SFA611101R1002](#) [1SFA611130R1103](#) [1SFA611131R1101](#) [1SFA611143R1101](#) [1SFA611202R1108](#) [1SFA611203R1108](#) [1SFA611215R1001](#) [1SFA611216R1108](#) [1SFA611285R1002](#) [1SFA611702R6006](#) [1SFA616162R1025](#) [1SFA619100R3015](#) [1SVR730020R0200](#) [IPC4111](#) [OS30FACC12](#) [OS60GJ03](#) [OVR1N160277PS](#) [OXC1L48](#)