

177013

# PF515 PF516 Heatsink - T03

Space saving design together with good thermal efficiency. Available in two fin heights.  
 Finish: Black anodised.

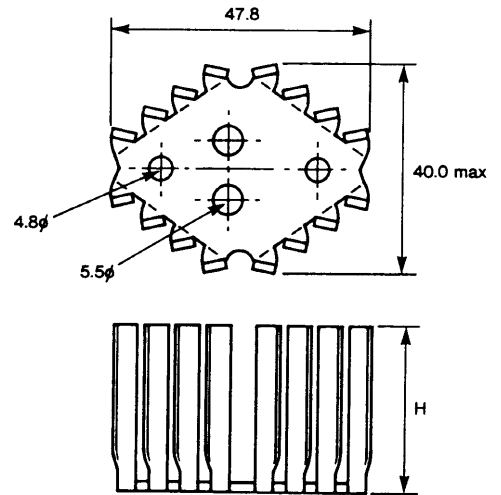
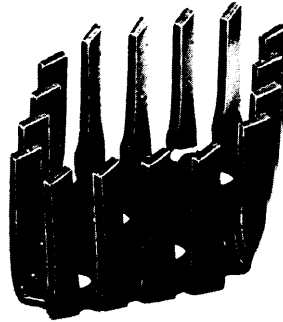
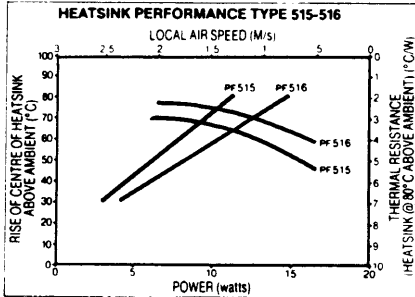

PF515 H = 25.4     $\Theta = 6.9^\circ \text{ C/W}$   
 PF516 H = 31.7     $\Theta = 5.3^\circ \text{ C/W}$

# PF523 PF526 PF527 Heatsink - T03

Space saving heatsinks clamp over T03 case without disturbing the device connections and using almost no additional board space.  
 Finish: Black anodised.

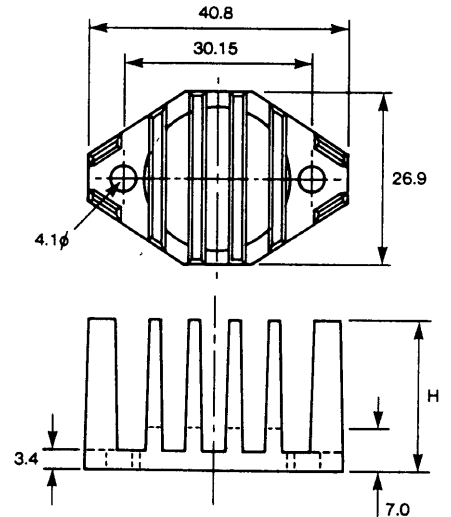
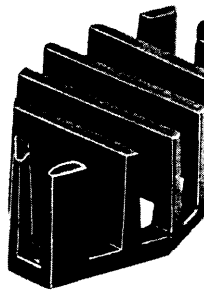
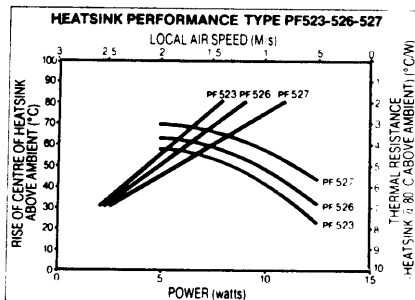

PF523 H = 12.5     $\Theta = 9.9^\circ \text{ C/W}$   
 PF526 H = 19     $\Theta = 8.8^\circ \text{ C/W}$   
 PF527 H = 25     $\Theta = 7.3^\circ \text{ C/W}$

# AV16 Heatsink - T03 AV17 Heatsink - T0220 (x 2)

4 sided heatsink with alternate sloping vanes designed for maximum dissipation surface and low unit cost.  
 Finish: Black anodised

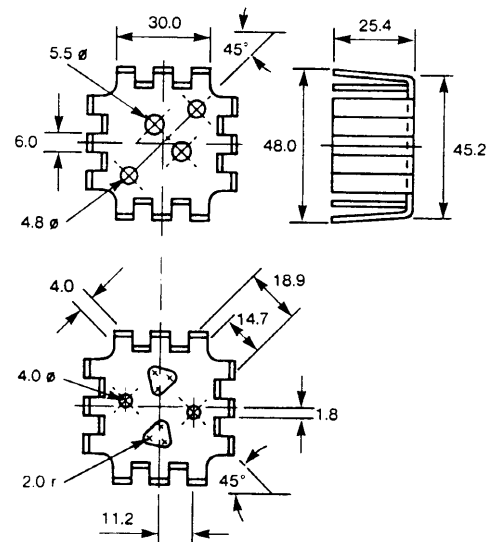
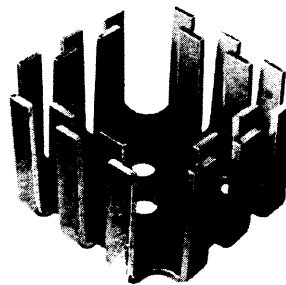
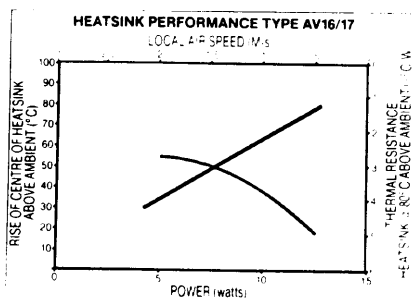

AV16 T03     $\Theta = 6^\circ \text{ C/W}$   
 AV17 T0220 (x2)     $\Theta = 6^\circ \text{ C/W}$

## Standard Hole Patterns

### TO3

Available in all standard lengths of the following powersink types:

L LA MA MB MD ME MH MK Q T W Y

To order, add -2 to the length/type code.  
e.g. 4L-2 6W-2 etc.

M type is also available but should be ordered as 2M-16 etc.

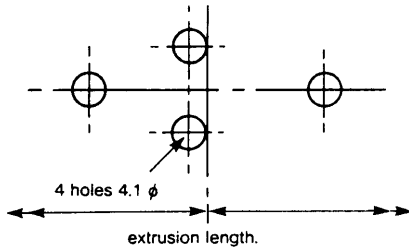

### 2 x T03

Length 'L'	Dimn 'A'
100mm	26.3
4"	27.1
6"/150mm	46.2

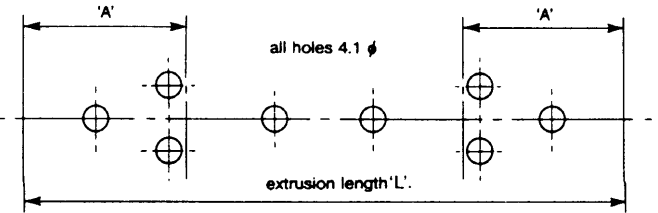

Available in standard lengths of the following types:

L LA M MA MB MD ME MH MK Q T W

To order, add -4 to the length/type code.  
e.g. 4Q-4 MK150-4 etc.

### 2 x T03 (Y)

	Dimn 'A'
3.5Y-4	21.5
4Y-4	27.8
6Y-4	43.6

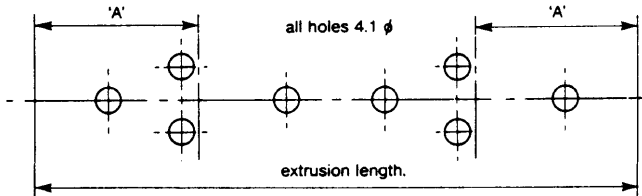

### TO3 (MG)

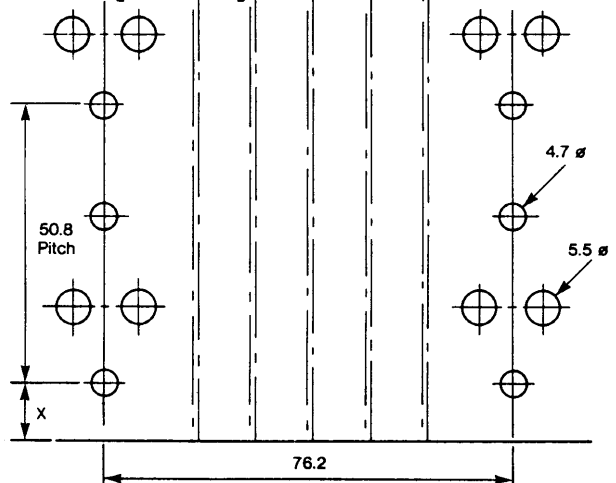

- 3MG-8 (2 x TO3) x = 23
- 4MG-10 (4 x TO3) x = 10.3
- 6MG-14 (6 x TO3) x = 10.3
- 8MG-22 (8 x TO3) x = 10.3

### TO66

3M-3 4M-3  
2Y-3 3Y-3 3.5Y-3 4Y-3

TO66 hole pattern in other lengths and extrusions to order.

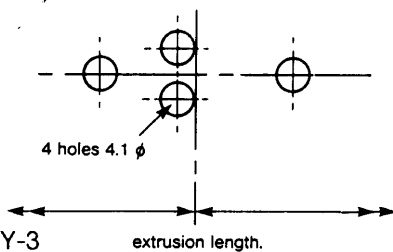

### TO220 (MC)

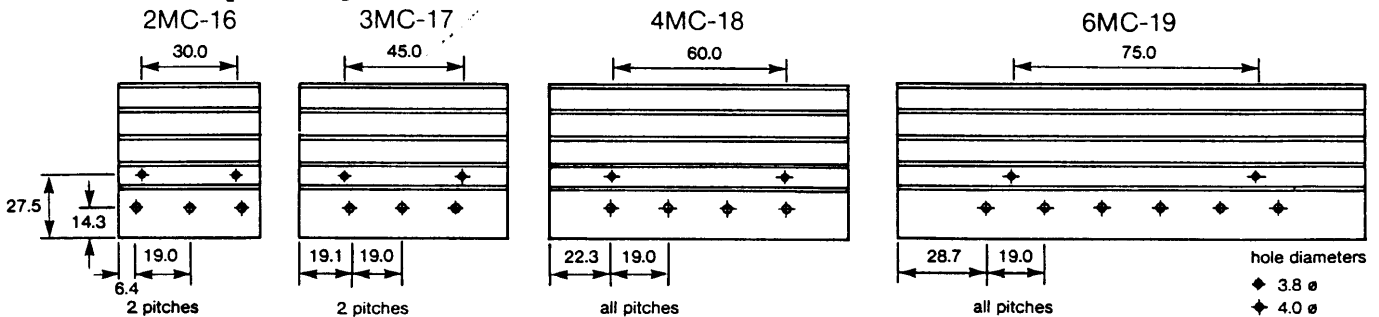

### Installation Notches

Standard installation notches available in types P PC and PD  
Number of notches and position to order.

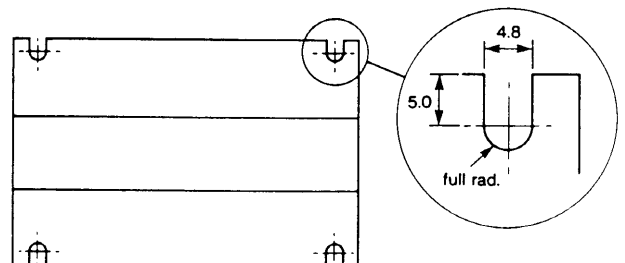

## X-ON Electronics

Largest Supplier of Electrical and Electronic Components

*Click to view similar products for [avid](#) manufacturer:*

Other Similar products are found below :

[4005G](#) [097995X](#) [593101B03600G](#) [0S509-140-U](#) [6W-1](#) [097987X](#) [098047EB](#) [358890](#) [2207/PR11B-2ASSYG](#) [780153U04600G](#)

[622852F00000G](#) [THM6070B](#) [782452F00000G](#) [520329A00000G](#) [241404B91200G318382](#) [025069A](#) [098067H](#) [7023B](#) [320105B00000G](#)

[623352F00000G](#) [607602F00000G](#) [098046G](#) [097990R](#) [358891](#) [654452F00000G](#) [780252F00000G](#) [SoftFlex-B016-20-01-4000-2000](#) [BS595-](#)

[50-B](#) [358894](#) [683601F00000](#) [7138DG](#) [4953G](#) [647061](#) [SW38-4](#) [THM6025B](#) [603402F00000G](#) [783452F00000G](#) [780802F00000G](#) [014379X](#)

[416301U00000G](#) [101800F00000G](#) [568103B00000G](#) [1130BG](#) [416601U00000G](#) [783502F00000G](#) [780652F00000G](#) [780302F00000G](#) [5901G](#)

[420932X](#) [725452F00000G](#)