

PCB Relay G5LE

A Cubic, Single-pole 10-A Power Relay

- High Capacity (-E) versions
- Subminiature “sugar cube” relay with universal footprint.
- Conforms to EN 61810-1. UL recognized/ CSA certified.
- UL class-F coil insulation model available (UL class-B coil insulation for standard model).
- Withstands impulse of up to 4,500 V.
- 400-mW and 360-mW coil power types available.
- RoHS Compliant



Ordering Information

| Enclosure ratings | Contact form/Style | Contact material | | |
|-------------------|--------------------|-------------------------|---------------------------------|---------------|
| | | AgSnO ₂ | AgSnIn | |
| | | Standard | Standard | High Capacity |
| Flux protection | SPDT | G5LE-1 G5LE-1-CF | G5LE-1-ASI G5LE-1-ASI-CF | G5LE-1-E |
| | SPST-NO | G5LE-1A G5LE-1A-CF | G5LE-1A-ASI G5LE-1A-ASI-CF | G5LE-1A-E |
| Fully sealed | SPDT | G5LE-14 G5LE-14-CF | G5LE-14-ASI G5LE-14-ASI-CF | --- |
| | SPST-NO | G5LE-1A4 G5LE-1A4-CF | G5LE-1A4-ASI G5LE-1A4-ASI-CF | --- |

Note: When ordering, add the rated coil voltage to the model number.

Example: G5LE-1 DC12
└─── Rated coil voltage

Model Number Legend

G5LE - - - - - - - - - - - DC

1 2 3 4 5 6 7 8 9 10

1. Number of Poles

1: 1 pole

2. Contact Form

None: SPDT
 A: SPST-NO

3. Enclosure Ratings

None: Flux protection
 4: Fully sealed
 (Not applicable with -E versions)

4. Contact Material

None: AgSnO₂ (AgSnIn for -E versions)
 ASI: AgSnIn

5. Insulation System

None: Class B (Class F for -E versions)
 CF: Class F (UL and CSA only)

6. Classification

E: High capacity type

7. Coil Power Consumption/Coil Characteristic

None: Approx. 400 mW (Approx. 700mW for -G versions)
 36: Approx. 360 mW (Not applicable for -G versions)

8. Approved Standards

None: UL, CSA, and VDE

9. Packaging

None: Standard polystyrene tray
 SP: Anti-static tube packaging

10. Rated Coil Voltage

5, 9, 12, 24, 48 VDC

Specifications

■ Coil Ratings

400-mW Type

| Rated voltage | 5 VDC | 9 VDC | 12 VDC | 24 VDC | 48 VDC |
|----------------------|--|-------|---------|---------|---------|
| Rated current | 79.4 mA | 45 mA | 33.3 mA | 16.7 mA | 8.33 mA |
| Coil resistance | 63 Ω | 200 Ω | 360 Ω | 1,440 Ω | 5,760 Ω |
| Must operate voltage | 75% max. of rated voltage (max.) | | | | |
| Must release voltage | 10% min. of rated voltage (min.) | | | | |
| Max. voltage | 130% of rated voltage at 85°C, 170% of rated voltage at 23°C | | | | |
| Power consumption | Approx. 400 mW | | | | |

Note: The rated current and coil resistance are measured at a coil temperature of 23°C with a tolerance of ±10%.

360-mW Type

| Rated voltage | 5 VDC | 9 VDC | 12 VDC | 24 VDC | 48 VDC |
|----------------------|--|-------|--------|---------|---------|
| Rated current | 72 mA | 40 mA | 30 mA | 15 mA | 7.5 mA |
| Coil resistance | 70 Ω | 225 Ω | 400 Ω | 1,600 Ω | 6,400 Ω |
| Must operate voltage | 75% max. of rated voltage (max.) | | | | |
| Must release voltage | 10% min. of rated voltage (min.) | | | | |
| Max. voltage | 130% of rated voltage at 85°C, 170% of rated voltage at 23°C | | | | |
| Power consumption | Approx. 360 mW | | | | |

Note: The rated current and coil resistance are measured at a coil temperature of 23°C with a tolerance of ±10%.

■ Contact Ratings

| | Standard | G5LE-E |
|-------------------------------------|--|---------------|
| Load | Resistive load (cosφ = 1) | |
| Rated load | 10 A at 120 VAC; 8 A at 30 VDC 10A at 240VAC (12 and 24 VDC coil) | 16A at 250VAC |
| Contact Material | AgSnO ₂ (AgSnIn optional) | AgSnIn |
| Rated carry current | 10 A | 16A |
| Max. switching voltage | 250 VAC, 125 VDC (30 VDC when UL/CSA standard is applied) | 250VAC |
| Max. switching current | AC: 10 A; DC: 8 A | AC: 16A |
| Max. switching power | 1,200 VA, 240 W | 4,000VA |
| Minimum Permissible Load (See note) | 100 mA at 5 VDC | |

Note: Reference value - P level: $\lambda_{60} = 0.1 \times 10^{-6}$ operations

■ Characteristics

| | | |
|----------------------------------|--|--|
| Contact resistance | 100 mΩ max. | |
| Operate time | 10 ms max. | |
| Release time | 5 ms max. | |
| Bounce Time | Operate: Approx. 0.6ms Release: Approx. 7.2ms | |
| Max. switching frequency | Mechanical: | 18,000 operations/hr |
| | Electrical: | 1,800 operations/hr at rated load |
| Insulation resistance | 100 MΩ min. (at 500 VDC) | |
| Dielectric strength | 2,000 VAC, 50/60 Hz for 1 min between coil and contacts 750 VAC, 50/60 Hz for 1 min between contacts of same polarity | |
| Impulse withstand voltage | 4,500 V (1.2 x 50 μs) between coil and contacts | |
| Insulation Distance | Creepage (Typ) | 3.3 mm |
| | Clearance (Typ) | 2.7 mm |
| Tracking Resistance (CTI) | 250 V | |
| Vibration resistance | Destruction: | 10 to 55 to 10 Hz, 0.75-mm single amplitude (1.5-mm double amplitude) |
| | Malfunction: | 10 to 55 to 10 Hz, 0.75-mm single amplitude (1.5-mm double amplitude) |
| Shock resistance | Destruction: | 1,000 m/s ² |
| | Malfunction: | 100 m/s ² |
| Endurance | Mechanical: | 10,000,000 operations min. (at 18,000 operations/hr) |
| | Electrical: | 100,000 operations min. (at 1,800 operations/hr) for standard type 36,000 operations min. (10A at 250VAC) 100,000 operations min. (at 1,800 operations/hr), 12A 250 VAC) - applicable for G5LE-1-E,NO contact only |
| Ambient temperature | Operating: -40°C to 85°C (with no icing) | |
| Ambient humidity | Operating: 5% to 85% | |
| Weight | Approx. 12 g | |

■ Approved Standards

UL Recognized (File No. E41643)

CSA Certified (File No. LR34815)

| Model | Coil rating | Contact rating |
|-------|---------------------------|--|
| G5LE | 3 to 48 VDC (Standard) | 10 A, 250 VAC (general use), 6,000 cycles, 40°C (excluding -G type) 10 A, 125 VAC (general use), 100,000 cycles, 40°C (excluding -E, -G types) 8 A, 30 VDC (resistive load), 6,000 cycles, 40°C (excluding -E, -G types) 125 VA, 125 VAC, pilot duty, 100,000 cycles, 105°C (excluding -G type) NO: 13 A, 120 VAC, resistive, 100,000 cycles, 85°C (AgSnO ₂ & -E types, only) 1/2 hp, 125 VAC, 100,000 cycles, 40°C (excluding -G type) 1/3 hp, 125 VAC, 30,000 cycles, 70°C (AgSnO ₂ type only, excluding -E, -G types) 400W-T (3.3A), 120 VAC, tungsten, 100,000 cycles (AgSnO ₂ type only, excluding -E, -G types) TV-5, 120 VAC, 40°C (-ASI type only, excluding -E, -G types) 12 A, 250 VAC, general use, 100,000 cycles, 1s=on, 1s=off, 105°C (-E type only) TV-8, 120 VAC, 25,000 cycles, 40°C (-E type only) 10 A, 35 VDC, resistive, 100,000 cycles, 1s=on, 1s=off, 40°C (-G type only) NC: 12 A, 250 VAC, general use, 30,000 cycles, 1s=on, 9s=off, 40°C (-E type only) 10 A, 35 VDC, resistive, 50,000 cycles, 5s=on, 5s=off, 40°C (-G type only) 1/8 hp, 120 VAC, 50,000 cycles, 40°C (AgSnO ₂ type only, excluding -E, -G types) |
| | 5 to 24 VDC (-E versions) | |

EN 61810-1, EN 60255, IEC (VDE TUV Reg No. R9151267, VDE Reg No. 6850UG)

| Model | Coil rating | Contact rating |
|-------|--|---|
| G5LE | Approx. 400 mW 3, 5, 6, 9, 12, 24, 48 VDC Approx. 360 mW 5, 6, 12, 24, 48 VDC | 10A, 250VAC (resistive load, 50,000 cycles at 85°C) 5A, 30VDC 2.5 A, 250 VAC (cosφ = 0.4) |

Engineering Data

For standard type

Max. Switching Capacity

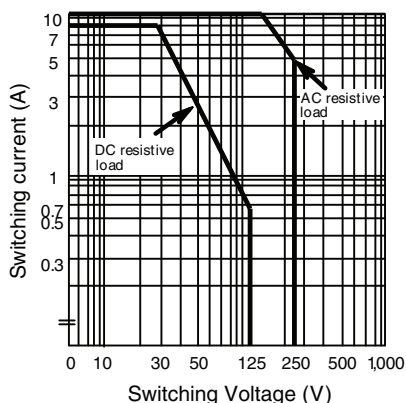

Life Expectancy

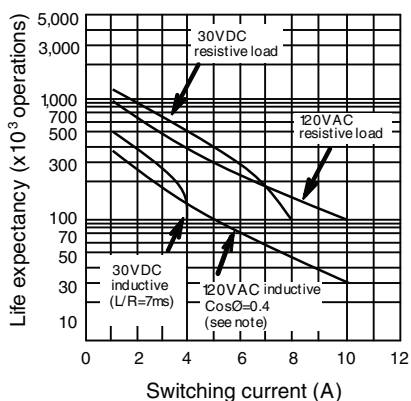

Note: Same curve as for 250-VAC resistive load

Ambient Temp. Vs. Max. Voltage

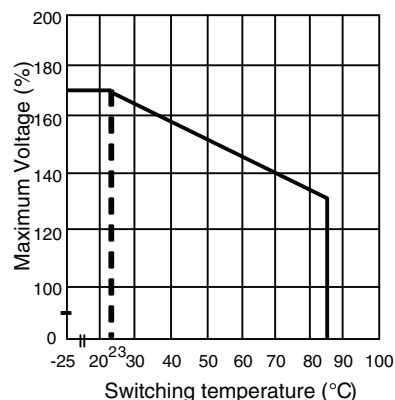

Note: The maximum coil voltage refers to the maximum value in a varying range of operating power voltage, not a continuous voltage.

For suffix -E

Max. Switching Capacity

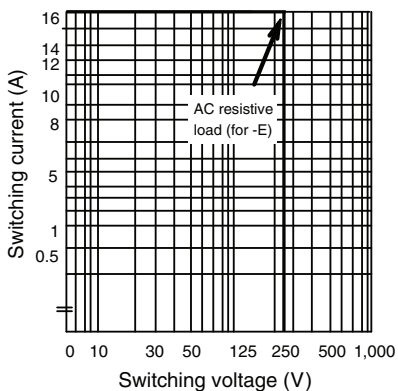

Life Expectancy

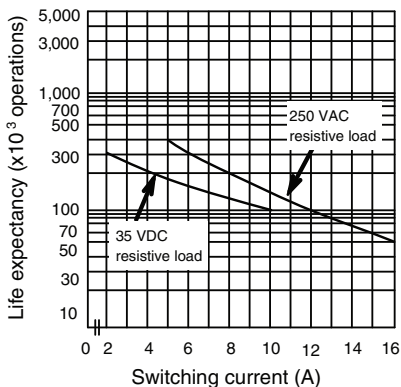

Ambient Temp. Vs. Max. Voltage

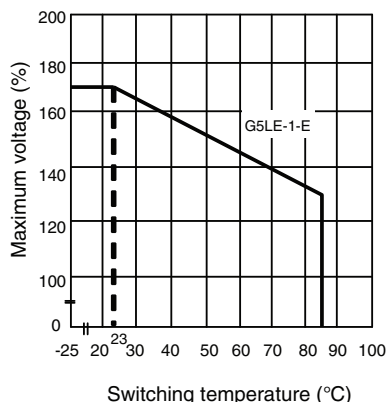

Note: The maximum coil voltage refers to the maximum value in a varying range of operating power voltage, not a continuous voltage.

Dimensions

Note: 1. All units are in millimeters unless otherwise indicated.
 2. Orientation marks are indicated as follows:

G5LE-1 G5LE-1A

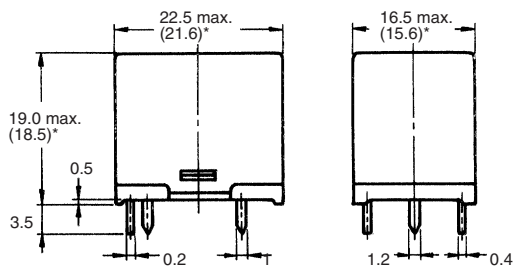
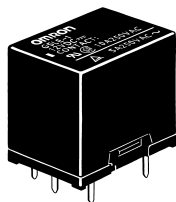

*Average value

G5LE-14 G5LE-1A4

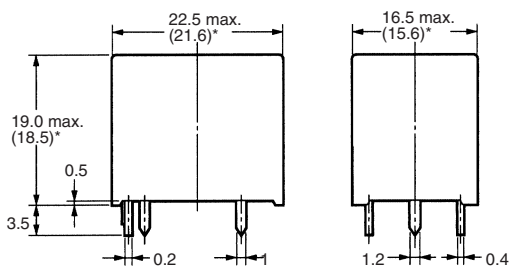
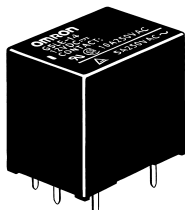

*Average value

Terminal Arrangement/Internal Connections (Bottom View)

SPDT

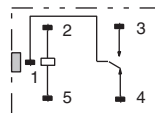

Mounting Holes (Bottom View)

Tolerance: ± 0.1 mm unless specified

SPDT

Five, $1.3^{+0.2}_0$ dia. holes

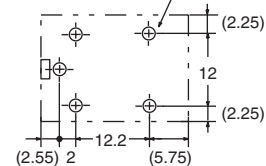

Terminal Arrangement/Internal Connections (Bottom View)

SPST-NO

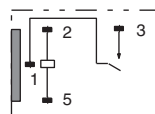

Mounting Holes (Bottom View)

Tolerance: ± 0.1 mm unless specified

SPST-NO

Four, $1.3^{+0.2}_0$ dia. holes

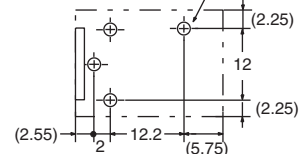

All sales are subject to Omron Electronic Components LLC standard terms and conditions of sale, which can be found at http://www.components.omron.com/components/web/webfiles.nsf/sales_terms.html

ALL DIMENSIONS SHOWN ARE IN MILLIMETERS.
To convert millimeters into inches, multiply by 0.03937. To convert grams into ounces, multiply by 0.03527.

OMRON[®]

**OMRON ELECTRONIC
COMPONENTS LLC**

55 E. Commerce Drive, Suite B
Schaumburg, IL 60173

847-882-2288

OMRON ON-LINE

Global - <http://www.omron.com>

USA - <http://www.components.omron.com>

Cat. No. X301-E-1d

08/13

Specifications subject to change without notice

Printed in USA

X-ON Electronics

Largest Supplier of Electrical and Electronic Components

Click to view similar products for [General Purpose Relays](#) category:

Click to view products by [Omron](#) manufacturer:

Other Similar products are found below :

[APF30318](#) [JVN1AF-4.5V-F](#) [PCN-105D3MHZ](#) [5JO-10000S-SIL](#) [5JO-1000CD-SIL](#) [5JO-400CD-SIL](#) [LY2S-AC220/240](#) [LYQ20DC12](#)
[6031007G](#) [6131406HQ](#) [6-1393099-3](#) [6-1393099-8](#) [6-1393122-4](#) [6-1393123-2](#) [6-1393767-1](#) [6-1393843-7](#) [6-1415012-1](#) [6-1419102-2](#) [6-](#)
[1423698-4](#) [6-1608051-6](#) [6-1608067-0](#) [6-1616170-6](#) [6-1616248-2](#) [6-1616282-3](#) [6-1616348-2](#) [6-1616350-1](#) [6-1616350-8](#) [6-1616358-7](#) [6-](#)
[1616359-9](#) [6-1616360-9](#) [6-1616931-6](#) [6-1617039-1](#) [6-1617052-1](#) [6-1617090-2](#) [6-1617090-5](#) [6-1617347-5](#) [6-1617353-3](#) [6-1617801-8](#) [6-](#)
[1617802-2](#) [6-1618107-9](#) [6-1618248-4](#) [M83536/1-027M](#) [CX-4014](#) [MAHC-5494](#) [MAVCD-5419-6](#) [703XCX-120A](#) [7-1393100-5](#) [7-1393111-7](#)
[7-1393144-5](#) [7-1393767-8](#)