

Interface relays and optocouplers

Product group picture

5

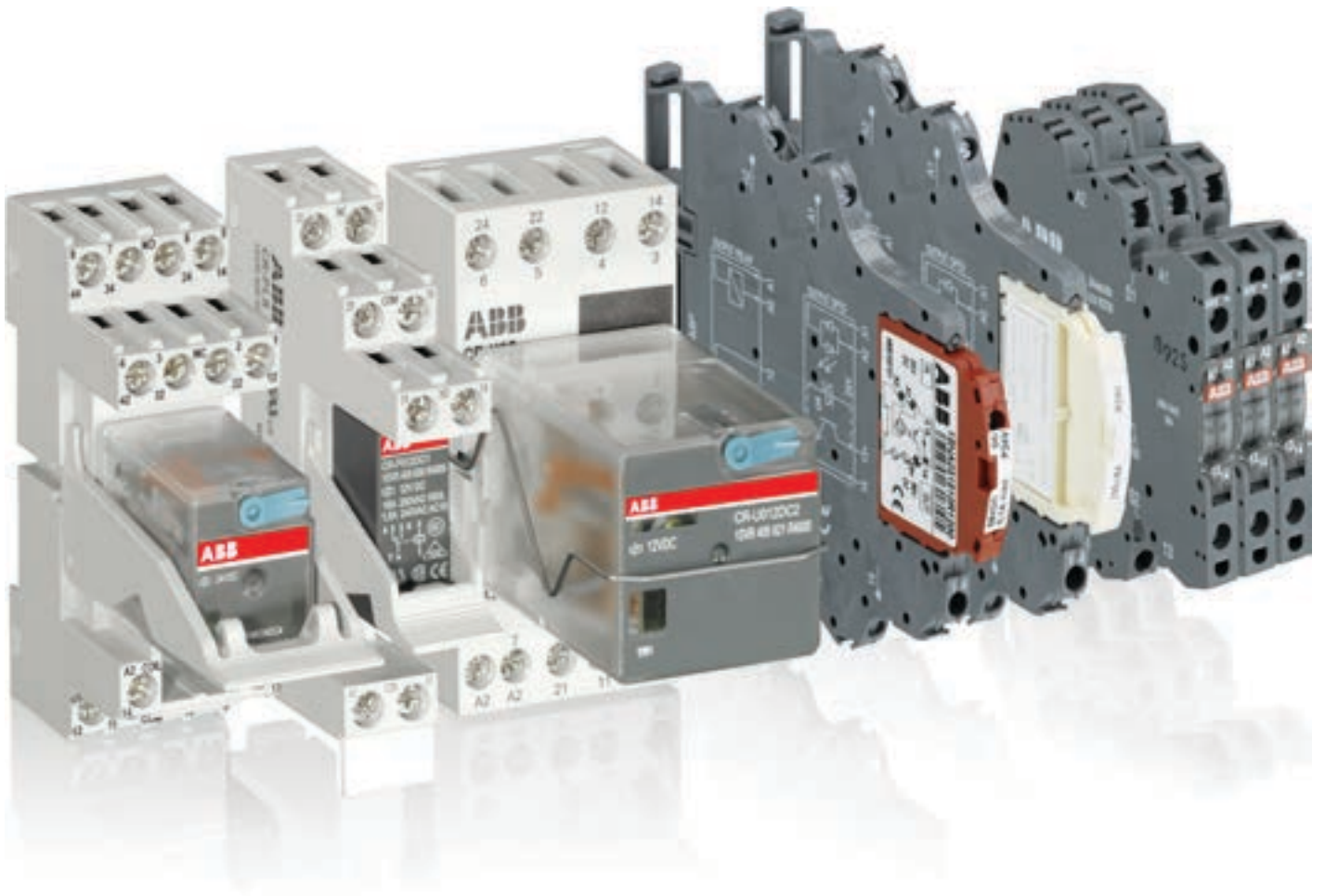

Interface relays and optocouplers

Table of contents

Interface Relays and Optocouplers	
Pluggable interface relays	5/3
Table of contents	5/4
Benefits and advantages	5/5
Approvals and marks	5/6
Ordering details	5/7
Technical data	5/14
Technical data, Load limit curves	5/16
Load limit curves	5/17
Connection diagrams	5/18
Interface relays and optocouplers R500 / R600 range	5/21
Table of contents	5/22
Benefits and advantages	5/23
Type designators	5/24
Interface relays and optocouplers R500 range	5/25
Table of contents	5/26
Interface relays R500 range	5/27
Table of contents	5/28
Selection	5/29
Ordering details	5/30
Technical information	5/31
Optocouplers R500 range	5/33
Table of contents	5/34
Selection	5/35
Ordering details	5/36
Connection diagrams	5/37
Technical data	5/38
Interface relays and optocouplers R600 range	5/45
Table of contents	5/46
Interface relays R600 range	5/47
Table of contents	5/48
Benefits and advantages	5/49
Selection	5/51
Ordering details	5/53
Connection diagrams	5/55
Technical data	5/56
General technical data	5/61
Dimensional drawings, Load limit curves	5/62
Optocouplers R600 range	5/63
Table of contents	5/64
Selection	5/65
Ordering details	5/67
Connection diagrams	5/68
Technical data	5/69

Pluggable interface relays

Product group picture

5

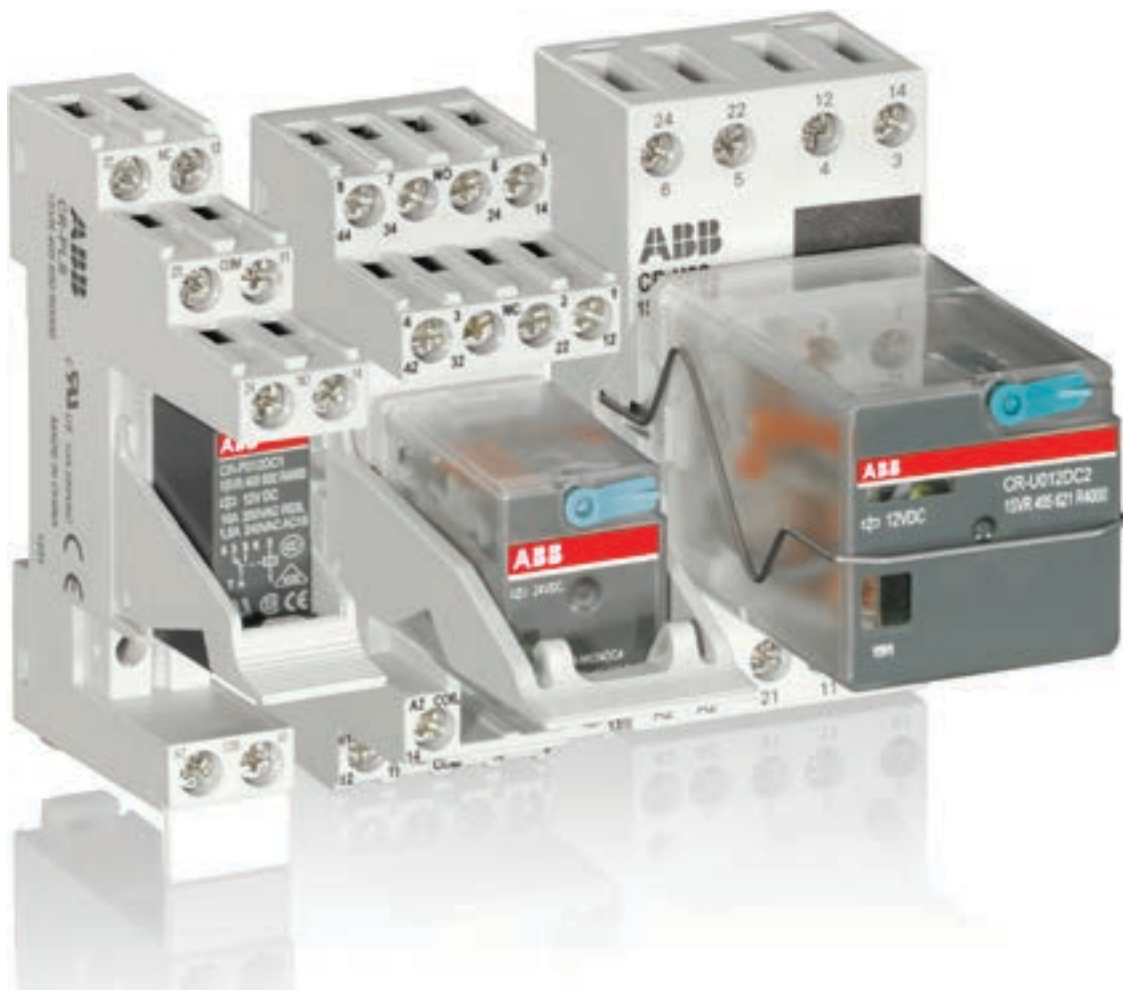

Pluggable interface relays

Table of contents

Pluggable interface relays	
Product group picture	5/3
Table of contents	5/4
Benefits and advantages	5/5
Approvals and marks	5/6
Ordering details	5/7
Technical data	5/14
Technical data, Load limit curves	5/16
Load limit curves	5/17
Connection diagrams	5/18

Pluggable interface relays

Benefits and advantages

Pluggable pcb relays CR-P

- 9 different coil voltages
 - DC versions: 12 V, 24 V, 48 V, 110 V
 - AC versions: 24 V, 48 V, 110 V, 120 V, 230 V
- Output contacts:
 - 1 c/o contact (16 A) or
 - 2 c/o contacts (8 A) optionally equipped with gold contacts
- Logical or standard sockets
- Cadmium-free contact material
- Width of socket: 15,5 mm
- Pluggable function modules
 - Reverse polarity protection/ Free wheeling diode
 - LED indication
 - RC elements
 - Overvoltage protection

Pluggable miniature relays CR-M

- 12 different coil voltages
 - DC versions: 12 V, 24 V, 48 V, 60 V, 110 V, 125 V, 220 V
 - AC versions: 24 V, 48 V, 110 V, 120 V, 230 V
- Output contacts
 - 2 c/o contacts (12 A) or
 - 3 c/o contacts (10 A) or
 - 4 c/o contacts (6 A) optionally equipped with gold contacts, LED and free wheeling diode
- Integrated test button for manual actuation and locking of the output contacts (blue = DC, orange = AC) that can be removed if necessary
- With or without integrated LED
- Logical or standard sockets
- Cadmium-free contact material
- Width on socket: 27 mm
- Pluggable function modules
 - Reverse polarity protection/ Free wheeling diode
 - LED indication
 - RC elements
 - Overvoltage protection

Pluggable universal relays CR-U

- 12 different coil voltages
 - DC versions: 12 V, 24 V, 48 V, 110 V, 125 V, 220 V
 - AC versions: 24 V, 48 V, 60 V, 110 V, 120 V, 230 V
- Output contacts
 - 2 c/o contacts (10 A) or
 - 3 c/o contacts (10 A)
- Integrated test button for manual actuation and locking of the output contacts (blue = DC, orange = AC) that can be removed if necessary
- With or without integrated LED
- Cadmium-free contact material
- Width on socket: 38 mm
- Pluggable function modules
 - Reverse polarity protection/ Free wheeling diode
 - LED indication
 - RC elements
 - Overvoltage protection
 - Multifunction time module

5

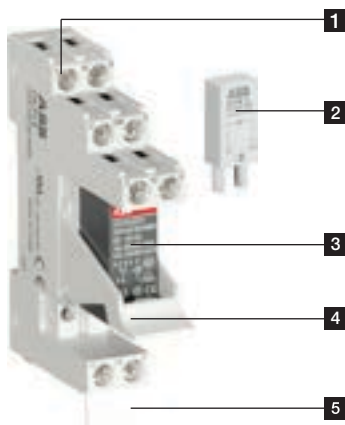

- 1** Socket
- 2** Pluggable function module
- 3** Interface relay
- 4** Holder
- 5** Marker label

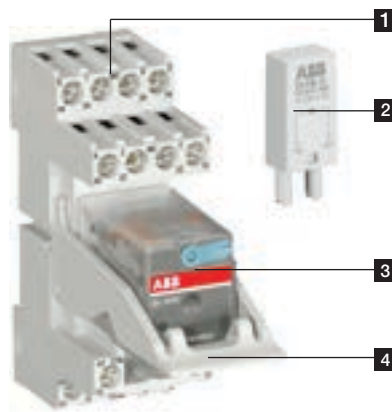

- 1** Socket
- 2** Pluggable function module
- 3** Interface relay
- 4** Holder

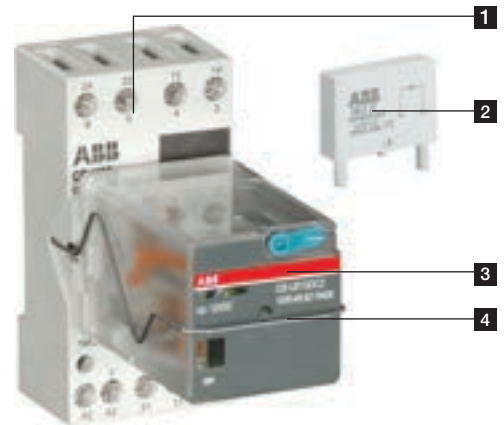

- 1** Socket
- 2** Pluggable function module
- 3** Interface relay
- 4** Holder

Pluggable interface relays

Approvals and marks

Kinds of sockets

Standard sockets - Position of connecting terminals:

Coil connection (A1-A2) on lower socket side, contact connections (n/o and n/c contacts) on the lower and upper socket side.

Logical sockets - Position of connecting terminals:

Coil connection (A1-A2) on lower socket side, all contact connections (common contacts, n/o and n/c contacts) on upper socket side.

Details see connection diagrams

Kind of connecting terminals

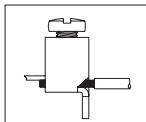

Screw type

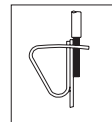

Spring type

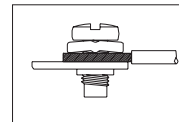

Fork type

Approvals and marks

		Relays			Sockets							Modules	
		CR-P	CR-M	CR-U	CR-PLS CR-PSS	CR-PLC	CR-M..L. CR-M..SS	CR-M..SF	CR-U..S CR-U..E	CR-U..SM	CR-P/M	CR-U	
■ existing	□ pending												
Approvals													
	UL 508	■	■ ¹⁾	■									
	CAN/CSA C22.2 No.14	■	■ ²⁾	■	■	■	■	■	■	■	■ ⁶⁾	■ ⁷⁾	
	CAN/CSA C22.2 No.14	■	■ ³⁾	■									
	VDE	■	■ ⁴⁾	■									
	GOST	■	■	■	■	■	■	■	■	■	■	■	■
	Lloyds Register		■ ⁵⁾	■									
	CCC	■	■	■									
	RMRS	■	■ ⁸⁾	■ ⁸⁾	■	■	■	■	■	■			
Marks													
	CE	■	■	■	■	■	■	■	■	■	■	■	■

¹⁾ except 60 V DC and 125 V DC devices with gold contacts

²⁾ except devices with gold contacts

³⁾ except 60 V DC and 125 V DC devices

⁴⁾ except 125 V DC devices

⁵⁾ only devices with 4 c/o contacts

⁶⁾ except CR-P/M 42B, CR-P/M 42BV, CR-P/M 42C, CR-P/M 42CV, CR-P/M 52D, CR-P/M 62E, CR-P/M 62EV, CR-P/M 62D, CR-P/M 62DV

⁷⁾ except CR-U 41B, CR-U 41BV, CR-U 41C, CR-U 41CV, CR-U 51D, CR-U 61CV, CR-U 61E, CR-U 61EV, CR-U 61D, CR-U 61DV, CR-U 91C, CR-U T

⁸⁾ except 60 V and 125 V devices

Pluggable interface relays

Ordering details



2CDC 291 045 F0004

CR-P

Description

Interface relays are widely used in various industrial applications:

As an interface they link the electronic controlling, e.g. PLC (programmable logic controller), PC or field bus systems, to the sensor / actuator level. Here, they take on various functions: Switching of AC or DC loads with different resistive, inductive and capacitive parts, switching voltages from a few mV up to 250 V, switching currents from a few mA up to 16 A, amplification of weak control signals, electrical isolation of control and load circuits, and signal multiplying. In contrast to electronic switching devices, interface relays don't use additional internal protective circuits and thus are overload-proof against short-time variations like current or voltage peaks.

Ordering details - CR-P range

Rated control supply voltage	Outputs	Contact ratings	Type	Order code	Price	Pkg	Weight (1 pce)
						qty	kg (lb)
12 V DC	1 c/o (SPDT)	250 V, 16 A	CR-P012DC1	1SVR405600R4000		10	0.014 (0.031)
24 V DC			CR-P024DC1	1SVR405600R1000			
48 V DC			CR-P048DC1	1SVR405600R6000			
110 V DC			CR-P110DC1	1SVR405600R8000			
24 V AC			CR-P024AC1	1SVR405600R0000			
48 V AC			CR-P048AC1	1SVR405600R5000			
110 V AC			CR-P110AC1	1SVR405600R7000			
120 V AC			CR-P120AC1	1SVR405600R2000			
230 V AC			CR-P230AC1	1SVR405600R3000			
12 V DC	2 c/o (SPDT)	250 V, 8 A	CR-P012DC2	1SVR405601R4000		10	0.014 (0.031)
24 V DC			CR-P024DC2	1SVR405601R1000			
48 V DC			CR-P048DC2	1SVR405601R6000			
110 V DC			CR-P110DC2	1SVR405601R8000			
24 V AC			CR-P024AC2	1SVR405601R0000			
48 V AC			CR-P048AC2	1SVR405601R5000			
110 V AC			CR-P110AC2	1SVR405601R7000			
120 V AC			CR-P120AC2	1SVR405601R2000			
230 V AC			CR-P230AC2	1SVR405601R3000			
24 V DC	2 c/o (SPDT) gold contact	250 V, 8 A	CR-P024DC2G	1SVR405606R1000		10	0.014 (0.031)
24 V AC			CR-P024AC2G	1SVR405606R0000			
110 V AC			CR-P110AC2G	1SVR405606R7000			
230 V AC			CR-P230AC2G	1SVR405606R3000			



2CDC 291 006 F0011

CR-PLS



2CDC 291 004 F0007

CR-PJ

Ordering details - Accessories

Version	Connection terminal	Type	Order code	Price	Pkg	Weight (1 pce)
					qty	kg (lb)
Logical socket with protective separation	screw	CR-PLS	1SVR405650R0000		10	0.045 (0.099)
	screw	CR-PLSx	1SVR405650R0100			0.043 (0.095)
Logical socket	spring	CR-PLC	1SVR405650R0200		10	0.042 (0.093)
	screw	CR-PSS	1SVR405650R1000			0.038 (0.084)
Standard socket					10	0.002 (0.004)
Plastic holder for socket		CR-PH	1SVR405659R0000		10	0.018 (0.040)
Jumper bar for sockets with screw connection		CR-PJ	1SVR405658R5000		10	0.0002 (0.0004)
Marker		CR-PM	1SVR405658R0000		10	

Bold printed products = stocked products

Pluggable interface relays

Ordering details



2CDC 291 046 F0004

CR-M

Description

Interface relays are widely used in various industrial applications:

As an interface they link the electronic controlling, e.g. PLC (programmable logic controller), PC or field bus systems, to the sensor / actuator level. Here, they take on various functions: Switching of AC or DC loads with different resistive, inductive and capacitive parts, switching voltages from a few mV up to 250 V, switching currents from a few mA up to 16 A, amplification of weak control signals, electrical isolation of control and load circuits, and signal multiplying. In contrast to electronic switching devices, interface relays don't use additional internal protective circuits and thus are overload-proof against short-time variations like current or voltage peaks.

Ordering details - CR-M range without LED

Rated control supply voltage	Outputs	Contact ratings	Type	Order code	Price	Pkg qty	Weight (1 pce) kg (lb)				
12 V DC	2 c/o (SPDT)	250 V, 12 A	CR-M012DC2	1SVR405611R4000		10	0.033 (0.073)				
24 V DC			CR-M024DC2	1SVR405611R1000							
48 V DC			CR-M048DC2	1SVR405611R6000							
60 V DC			CR-M060DC2	1SVR405611R4200							
110 V DC			CR-M110DC2	1SVR405611R8000							
125 V DC			CR-M125DC2	1SVR405611R8200							
220 V DC			CR-M220DC2	1SVR405611R9000							
24 V AC			CR-M024AC2	1SVR405611R0000							
48 V AC			CR-M048AC2	1SVR405611R5000							
110 V AC			CR-M110AC2	1SVR405611R7000							
120 V AC			CR-M120AC2	1SVR405611R2000							
230 V AC			CR-M230AC2	1SVR405611R3000							
12 V DC			3 c/o (SPDT)	250 V, 10 A	CR-M012DC3			1SVR405612R4000		10	0.033 (0.073)
24 V DC					CR-M024DC3			1SVR405612R1000			
48 V DC	CR-M048DC3	1SVR405612R6000									
60 V DC	CR-M060DC3	1SVR405612R4200									
110 V DC	CR-M110DC3	1SVR405612R8000									
125 V DC	CR-M125DC3	1SVR405612R8200									
220 V DC	CR-M220DC3	1SVR405612R9000									
24 V AC	CR-M024AC3	1SVR405612R0000									
48 V AC	CR-M048AC3	1SVR405612R5000									
60 V AC	CR-M060AC3	1SVR405612R5200									
110 V AC	CR-M110AC3	1SVR405612R7000									
120 V AC	CR-M120AC3	1SVR405612R2000									
230 V AC	CR-M230AC3	1SVR405612R3000									
12 V DC	4 c/o (SPDT)	250 V, 6 A			CR-M012DC4	1SVR405613R4000		10	0.033 (0.073)		
24 V DC			CR-M024DC4	1SVR405613R1000							
48 V DC			CR-M048DC4	1SVR405613R6000							
60 V DC			CR-M060DC4	1SVR405613R4200							
110 V DC			CR-M110DC4	1SVR405613R8000							
125 V DC			CR-M125DC4	1SVR405613R8200							
220 V DC			CR-M220DC4	1SVR405613R9000							
24 V AC			CR-M024AC4	1SVR405613R0000							
48 V AC			CR-M048AC4	1SVR405613R5000							
110 V AC			CR-M110AC4	1SVR405613R7000							
120 V AC			CR-M120AC4	1SVR405613R2000							
230 V AC			CR-M230AC4	1SVR405613R3000							

Bold printed products = stocked products

Pluggable interface relays

Ordering details



CR-M

2CDC 291 046 F0004

Ordering details - CR-M range

Rated control supply voltage	Outputs	Contact ratings	Type	Order code	Price	Pkg qty	Weight (1 pce)				
							kg (lb)				
12 V DC	2 c/o (SPDT) with LED	250 V, 12 A	CR-M012DC2L	1SVR405611R4100		10	0.033 (0.073)				
24 V DC			CR-M024DC2L	1SVR405611R1100							
48 V DC			CR-M048DC2L	1SVR405611R6100							
60 V DC			CR-M060DC2L	1SVR405611R4300							
110 V DC			CR-M110DC2L	1SVR405611R8100							
125 V DC			CR-M125DC2L	1SVR405611R8300							
220 V DC			CR-M220DC2L	1SVR405611R9100							
24 V AC			CR-M024AC2L	1SVR405611R0100							
48 V AC			CR-M048AC2L	1SVR405611R5100							
110 V AC			CR-M110AC2L	1SVR405611R7100							
120 V AC			CR-M120AC2L	1SVR405611R2100							
230 V AC			CR-M230AC2L	1SVR405611R3100							
12 V DC			3 c/o (SPDT) with LED	250 V, 10 A	CR-M012DC3L			1SVR405612R4100		10	0.033 (0.073)
24 V DC					CR-M024DC3L			1SVR405612R1100			
48 V DC	CR-M048DC3L	1SVR405612R6100									
60 V DC	CR-M060DC3L	1SVR405612R4300									
110 V DC	CR-M110DC3L	1SVR405612R8100									
125 V DC	CR-M125DC3L	1SVR405612R8300									
220 V DC	CR-M220DC3L	1SVR405612R9100									
24 V AC	CR-M024AC3L	1SVR405612R0100									
48 V AC	CR-M048AC3L	1SVR405612R5100									
110 V AC	CR-M110AC3L	1SVR405612R7100									
120 V AC	CR-M120AC3L	1SVR405612R2100									
230 V AC	CR-M230AC3L	1SVR405612R3100									
12 V DC	4 c/o (SPDT) with LED	250 V, 6 A			CR-M012DC4L	1SVR405613R4100		10	0.033 (0.073)		
24 V DC					CR-M024DC4L	1SVR405613R1100					
48 V DC			CR-M048DC4L	1SVR405613R6100							
60 V DC			CR-M060DC4L	1SVR405613R4300							
110 V DC			CR-M110DC4L	1SVR405613R8100							
125 V DC			CR-M125DC4L	1SVR405613R8300							
220 V DC			CR-M220DC4L	1SVR405613R9100							
24 V AC			CR-M024AC4L	1SVR405613R0100							
48 V AC			CR-M048AC4L	1SVR405613R5100							
110 V AC			CR-M110AC4L	1SVR405613R7100							
120 V AC			CR-M120AC4L	1SVR405613R2100							
230 V AC2			CR-M230AC4L	1SVR405613R3100							
24 V DC			4 c/o (SPDT), LED and free-wheeling diode	250 V, 6 A	CR-M024DC4LD	1SVR405614R1100				10	0.033 (0.073)
24 V DC			4 c/o (SPDT), gold contacts	250 V, 6 A	CR-M024DC4G	1SVR405618R1000				10	0.033 (0.073)
24 V AC	CR-M024AC4G	1SVR405618R0000									
110 V AC	CR-M110AC4G	1SVR405618R7000									
230 V AC	CR-M230AC4G	1SVR405618R3000									

Bold printed products = stocked products

Pluggable interface relays

Ordering details



CR-M

2CDC 291 046 F0004

Rated control supply voltage	Outputs	Contact ratings	Type	Order code	Price	Pkg	Weight (1 pce)
						qty	kg (lb)
12 V DC	4 c/o (SPDT) with gold contacts and LED	250 V / 6 A	CR-M012DC4LG	1SVR405618R4100		10	0.033 (0.073)
24 V DC			CR-M024DC4LG	1SVR405618R1100			
48 V DC			CR-M048DC4LG	1SVR405618R6100			
60 V DC			CR-M060DC4LG	1SVR405618R4300			
110 V DC			CR-M110DC4LG	1SVR405618R8100			
125 V DC			CR-M125DC4LG	1SVR405618R8300			
220 V DC			CR-M220DC4LG	1SVR405618R9100			
24 V AC			CR-M024AC4LG	1SVR405618R0100			
48 V AC			CR-M048AC4LG	1SVR405618R5100			
110 V AC			CR-M110AC4LG	1SVR405618R7100			
120 V AC	CR-M120AC4LG	1SVR405618R2100					
230 V AC	CR-M230AC4LG	1SVR405618R3100					
12 V DC	4 c/o (SPDT) with gold contacts, LED and free-wheeling diode		CR-M012DC4LDG	1SVR405618R4400		10	0.033 (0.073)
24 V DC			CR-M024DC4LDG	1SVR405618R1400			

5



CR-M4SS

2CDC 291 009 F0011

Ordering details - Accessories

Version	Connection terminal	Type	Order code	Price	Pkg	Weight (1 pce)
					qty	kg (lb)
Logical socket for 2 c/o	screw	CR-M2LS	1SVR405651R1100		10	0.055 (0.121)
Logical socket for 3 c/o		CR-M3LS	1SVR405651R2100			0.062 (0.137)
Logical socket for 2/4 c/o		CR-M4LS	1SVR405651R3100			0.066 (0.146)
Logical socket for 2 c/o	spring	CR-M2LC	1SVR405651R1200		10	0.065 (0.143)
Logical socket for 2/4 c/o		CR-M4LC	1SVR405651R3200			0.066 (0.146)
Standard socket for 2 c/o	screw	CR-M2SS	1SVR405651R1000		10	0.066 (0.146)
Standard socket for 3 c/o		CR-M3SS	1SVR405651R2000			0.068 (0.150)
Standard socket for 2/4 c/o		CR-M4SS	1SVR405651R3000			0.070 (0.154)
Standard socket for 2 c/o	fork type	CR-M2SF	1SVR405651R1300		10	0.040 (0.088)
Standard socket for 2/4 c/o		CR-M4SF	1SVR405651R3300			0.048 (0.106)
Plastic holder		CR-MH	1SVR405659R1000		10	0.003 (0.007)
Metal holder		CR-MH1	1SVR405659R1100		10	0.0005 (0.001)
Jumper bar for sockets with screw connection		CR-MJ	1SVR405658R6000		10	0.029 (0.064)
Marker		CR-MM	1SVR405658R1000		10	0.0005 (0.001)

Bold printed products = stocked products



CR-MJ

Pluggable interface relays

Ordering details



2CDC291 005 S0011

CR-P/M ...

Ordering details - CR-P/M range (all products stocked)

Rated control supply voltage	Description	Version	Type	Order code	Price	Pkg qty	Weight (1 pce)	
							kg	lb
6-220 V DC	Diode - Reverse polarity protection/ free wheeling diode	A1+, A2-	CR-P/M 22	1SVR405651R0000		10	0.003	(0.007)
6-24 V DC	Diode and LED - Reverse polarity protection/ free wheeling diode	red, A1+, A2-	CR-P/M 42	1SVR405652R0000		10	0.003	(0.007)
24-60 V DC		green, A1+, A2-	CR-P/M 42V	1SVR405652R1000				
24-60 V DC		red, A1+, A2-	CR-P/M 42B	1SVR405652R4000				
24-60 V DC		green, A1+, A2-	CR-P/M 42BV	1SVR405652R4100				
110 V DC		red, A1+, A2-	CR-P/M 42C	1SVR405652R9000				
6-24 V AC		green, A1+, A2-	CR-P/M 42CV	1SVR405652R9100				
24-60 V AC	Spark quenching		CR-P/M 52B	1SVR405653R0000		10	0.003	(0.007)
110-230 V AC/DC			CR-P/M 52D	1SVR405653R4000				
110-230 V AC/DC			CR-P/M 52C	1SVR405653R1000				
6-24 V AC/DC	Diode, LED and reverse polarity protection	red, for DC A1+, A2-	CR-P/M 62	1SVR405654R0000		10	0.003	(0.007)
		green, for DC A1+, A2-	CR-P/M 62V	1SVR405654R1000				
24-60 V AC/DC		red, for DC A1+, A2-	CR-P/M 62E	1SVR405654R4000				
24-60 V AC/DC		green, for DC A1+, A2-	CR-P/M 62EV	1SVR405654R4100				
110 V DC		red, for DC A1+, A2-	CR-P/M 92	1SVR405654R0100				
110-230 V AC		green, for DC A1+, A2-	CR-P/M 92V	1SVR405654R1100				
6-24 V AC/DC	Varistor and LED Overvoltage protection	red, for DC A1+, A2-	CR-P/M 62C	1SVR405655R0000		10	0.003	(0.007)
		green, for DC A1+, A2-	CR-P/M 62CV	1SVR405655R1000				
24-60 V AC/DC		red, for DC A1+, A2-	CR-P/M 62D	1SVR405655R4000				
24-60 V AC/DC		green, for DC A1+, A2-	CR-P/M 62DV	1SVR405655R4100				
110 V DC		red, for DC A1+, A2-	CR-P/M 92C	1SVR405655R0100				
110-230 V AC		green, for DC A1+, A2-	CR-P/M 92CV	1SVR405655R1100				
24 V AC	Overvoltage protection		CR-P/M 72	1SVR405656R0000		10	0.002	(0.004)
115 V AC			CR-P/M 72A	1SVR405656R1000				
230 V AC			CR-P/M 82	1SVR405656R2000				

Connection diagrams

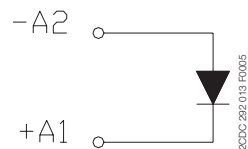

CR-P/M 22

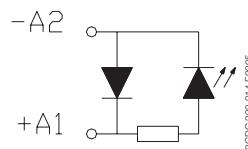

CR-P/M 42, CR-P/M 42C, CR-P/M 42BV, CR-P/M 42B, CR-P/M 42V, CR-P/M 42CV

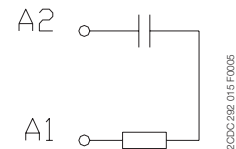

CR-P/M 52B, CR-P/M 52D, CR-P/M 52C

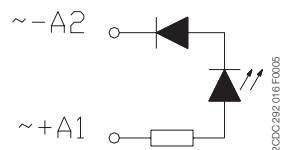

CR-P/M 62, CR-P/M 92, CR-P/M 62E, CR-P/M 62V, CR-P/M 62EV, CR-P/M 92V

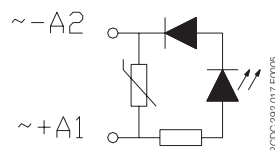

CR-P/M 62C, CR-P/M 92C, CR-P/M 62D, CR-P/M 62CV, CR-P/M 62DV, CR-P/M 92CV

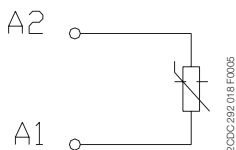

CR-P/M 72, CR-P/M 72A, CR-P/M 82

Pluggable interface relays

Ordering details



2CDC 291 047 F0004

CR-U

Description

Interface relays are widely used in various industrial applications:

As an interface they link the electronic controlling, e.g. PLC (programmable logic controller), PC or field bus systems, to the sensor / actuator level. Here, they take on various functions: Switching of AC or DC loads with different resistive, inductive and capacitive parts, switching voltages from a few mV up to 250 V, switching currents from a few mA up to 16 A, amplification of weak control signals, electrical isolation of control and load circuits, and signal multiplying. In contrast to electronic switching devices, interface relays don't use additional internal protective circuits and thus are overload-proof against short-time variations like current or voltage peaks.

Ordering details - CR-U range

Rated control supply voltage	Outputs	Contact ratings	Type	Order code	Price	Pkg qty	Weight (1 pce) kg (lb)				
12 V DC	2 c/o without LED	250 V, 10 A	CR-U012DC2	1SVR405621R4000		10	0.083 (0.183)				
24 V DC			CR-U024DC2	1SVR405621R1000							
48 V DC			CR-U048DC2	1SVR405621R6000							
110 V DC			CR-U110DC2	1SVR405621R8000							
220 V DC			CR-U220DC2	1SVR405621R9000							
24 V AC			CR-U024AC2	1SVR405621R0000							
48 V AC			CR-U048AC2	1SVR405621R5000							
110 V AC			CR-U110AC2	1SVR405621R7000							
120 V AC			CR-U120AC2	1SVR405621R2000							
230 V AC			CR-U230AC2	1SVR405621R3000							
12 V DC			3 c/o without LED	250 V, 10 A	CR-U012DC3			1SVR405622R4000		10	0.083 (0.183)
24 V DC					CR-U024DC3			1SVR405622R1000			
48 V DC					CR-U048DC3			1SVR405622R6000			
110 V DC					CR-U110DC3			1SVR405622R8000			
125 V DC	CR-U125DC3	1SVR405622R8200									
220 V DC	CR-U220DC3	1SVR405622R9000									
24 V AC	CR-U024AC3	1SVR405622R0000									
48 V AC	CR-U048AC3	1SVR405622R5000									
60 V AC	CR-U060AC3	1SVR405622R5200									
110 V AC	CR-U110AC3	1SVR405622R7000									
120 V AC	CR-U120AC3	1SVR405622R2000									
230 V AC	CR-U230AC3	1SVR405622R3000									
12 V DC	2 c/o with LED	250 V, 10 A			CR-U012DC2L	1SVR405621R4100		10	0.083 (0.183)		
24 V DC					CR-U024DC2L	1SVR405621R1100					
48 V DC			CR-U048DC2L	1SVR405621R6100							
110 V DC			CR-U110DC2L	1SVR405621R8100							
220 V DC			CR-U220DC2L	1SVR405621R9100							
24 V AC			CR-U024AC2L	1SVR405621R0100							
48 V AC			CR-U048AC2L	1SVR405621R5100							
110 V AC			CR-U110AC2L	1SVR405621R7100							
120 V AC			CR-U120AC2L	1SVR405621R2100							
230 V AC			CR-U230AC2L	1SVR405621R3100							
12 V DC			3 c/o with LED	250 V, 10 A	CR-U012DC3L	1SVR405622R4100				10	0.083 (0.183)
24 V DC					CR-U024DC3L	1SVR405622R1100					
48 V DC					CR-U048DC3L	1SVR405622R6100					
110 V DC					CR-U110DC3L	1SVR405622R8100					
220 V DC	CR-U220DC3L	1SVR405622R9100									
24 V AC	CR-U024AC3L	1SVR405622R0100									
48 V AC	CR-U048AC3L	1SVR405622R5100									
110 V AC	CR-U110AC3L	1SVR405622R7100									
120 V AC	CR-U120AC3L	1SVR405622R2100									
230 V AC	CR-U230AC3L	1SVR405622R3100									



2CDC 291 007 S0011

CR-U2S

Ordering details - Accessories

Version	Type	Order code	Price	Pkg qty	Weight (1 pce) kg (lb)
Socket for 2 c/o and module	CR-U2S	1SVR405670R0000		10	
Socket for 3 c/o and module	CR-U3S	1SVR405660R0000			
Socket for 3 c/o	CR-U3E	1SVR405660R0100			
Socket small for 2 c/o	CR-U2SM	1SVR405670R1100			
Socket small for 3 c/o	CR-U3SM	1SVR405660R1100			
Holder for CR-U socket	CR-UH	1SVR405669R0000			

Bold printed products = stocked products

Pluggable interface relays

Ordering details



CR-U...

2CDC 291 004 S0011

5

Ordering details - CR-U range (all products stocked)

Rated control supply voltage	Description	Version	Type	Order code	Price	Pkg	Weight (1 pce)	
							qty	kg (lb)
6-220 V DC	Diode - Reverse polarity protection/ free wheeling diode	A1+, A2-	CR-U 21	1SVR405661R0000		10	0.007	(0.015)
6-24 V DC	Diode and LED - Reverse polarity protection/ free wheeling diode	red, A1+, A2-	CR-U 41	1SVR405662R0000		10	0.007	(0.015)
24-60 V DC		green, A1+, A2-	CR-U 41V	1SVR405662R1000				
110 V DC		red, A1+, A2-	CR-U 41B	1SVR405662R4000				
6-24 V AC/DC		green, A1+, A2-	CR-U 41BV	1SVR405662R4100				
24-60 V AC/DC	Spark quenching	red, A1+, A2-	CR-U 41C	1SVR405662R9000		10	0.007	(0.015)
110-230 V AC/DC		green, A1+, A2-	CR-U 41CV	1SVR405662R9100				
6-24 V AC/DC			CR-U 51B	1SVR405663R0000				
24-60 V AC/DC	Diode and LED		CR-U 51D	1SVR405663R4000		10	0.007	(0.015)
110-230 V AC/DC			CR-U 51C	1SVR405663R1000				
6-24 V AC/DC		red, for DC A1+, A2-	CR-U 61	1SVR405664R0000				
24-60 V AC/DC	Diode and LED	green, for DC A1+, A2-	CR-U 61V	1SVR405664R1000		10	0.007	(0.015)
110 V DC		red, for DC A1+, A2-	CR-U 61E	1SVR405664R4000				
110-230 V AC		green, for DC A1+, A2-	CR-U 61EV	1SVR405664R4100				
6-24 V AC/DC		red, for DC A1+, A2-	CR-U 91	1SVR405664R0100				
24-60 V AC/DC	Varistor and LED Overvoltage protection	green, for DC A1+, A2-	CR-U 91V	1SVR405664R1100		10	0.007	(0.015)
110 V DC		red, for DC A1+, A2-	CR-U 61C	1SVR405665R0000				
110-230 V AC		green, for DC A1+, A2-	CR-U 61CV	1SVR405665R1000				
24 V AC		red, for DC A1+, A2-	CR-U 61D	1SVR405665R4000				
115 V AC	Overvoltage protection, varistor	green, for DC A1+, A2-	CR-U 61DV	1SVR405665R4100		10	0.007	(0.015)
230 V AC		red, for DC A1+, A2-	CR-U 91C	1SVR405665R0100				
24 V AC		green, for DC A1+, A2-	CR-U 91CV	1SVR405665R1100				
24-240 V AC/DC	Multifunction time module	pluggable onto CR-U2S and CR-U3S	CR-U T	1SVR405667R0000		10	0.014	(0.031)



CR-U T

2CDC 291 032 F0005

Connection diagrams

All CR-U modules can be plugged onto sockets CR-U2S and CR-U3S.

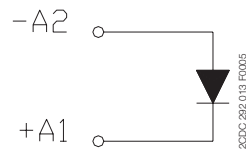

CR-U 21

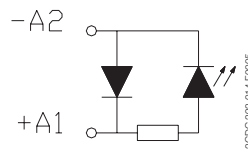

CR-U 41, CR-U 41B, CR-U 41C, CR-U 41V, CR-U 41BV, CR-U 41CV

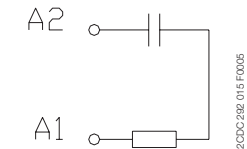

CR-U 51B, CR-U 51C CR-U 51D,

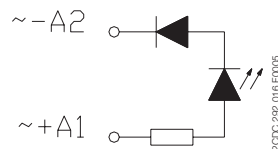

CR-U 61, CR-U 61E, CR-U 91, CR-U 61V, CR-U 61EV, CR-U 91V

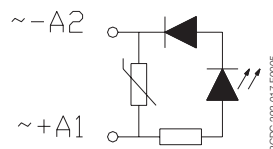

CR-U 61C, CR-U 61D, CR-U 91C, CR-U 61CV, CR-U 61DV CR-U 91CV

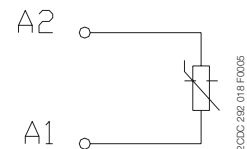

CR-U 71, CR-U 81 CR-U 71A,

Pluggable interface relays

Technical data

Input circuit - coil data

CR-P range

	Rated control supply voltage U_s	Rated frequency	Make voltage (at 20 °C)	Maximum voltage (at 55 °C)	Break voltage	Rated power	Coil resistance (at 20 °C)	Tolerance of coil resistance
DC coils	12 V DC	-	8.4 V DC	30.6 V DC	$\geq 0.1 U_s$	0.4-0.48 W	360 Ω	$\pm 10\%$
	24 V DC	-	16.8 V DC	61.2 V DC	$\geq 0.1 U_s$	0.4-0.48 W	1440 Ω	$\pm 10\%$
	48 V DC	-	33.6 V DC	122.4 V DC	$\geq 0.1 U_s$	0.4-0.48 W	5700 Ω	$\pm 10\%$
	110 V DC	-	77 V DC	280 V DC	$\geq 0.1 U_s$	0.4-0.48 W	25200 Ω	$\pm 10\%$
AC coils	24 V AC	50 / 60 Hz	19.2 V AC	28.8 V AC	$\geq 0.15 U_s$	0.75 VA	400 Ω	$\pm 10\%$
	48 V AC	50 / 60 Hz	38.4 V AC	57.6 V AC	$\geq 0.15 U_s$	0.75 VA	1550 Ω	$\pm 10\%$
	110 V AC	50 / 60 Hz	88 V AC	132 V AC	$\geq 0.15 U_s$	0.75 VA	8900 Ω	$\pm 10\%$
	120 V AC	50 / 60 Hz	96 V AC	144 V AC	$\geq 0.15 U_s$	0.75 VA	10200 Ω	$\pm 10\%$
	230 V AC	50 / 60 Hz	184 V AC	276 V AC	$\geq 0.15 U_s$	0.75 VA	38500 Ω	$\pm 10\%$

CR-M range

	Rated control supply voltage U_s	Rated frequency	Make voltage (at 20 °C)	Maximum voltage (at 55 °C)	Break voltage	Rated power	Coil resistance (at 20 °C)	Tolerance of coil resistance
DC coils	12 V DC	-	9.6 V DC	13.2 V DC	$\geq 0.1 U_s$	0.9 W	160 Ω	$\pm 10\%$
	24 V DC	-	19.2 DC	26.4 V DC	$\geq 0.1 U_s$	0.9 W	640 Ω	$\pm 10\%$
	48 V DC	-	38.4 V DC	52.8 V DC	$\geq 0.1 U_s$	0.9 W	2600 Ω	$\pm 10\%$
	60 V DC	-	48.0 V DC	66.0 V DC	$\geq 0.1 U_s$	0.9 W	4000 Ω	$\pm 10\%$
	110 V DC	-	88 V DC	121 V DC	$\geq 0.1 U_s$	0.9 W	13600 Ω	$\pm 10\%$
	125 V DC	-	100 V DC	137.5 V DC	$\geq 0.1 U_s$	0.9 W	16000 Ω	$\pm 10\%$
	220 V DC	-	176 V DC	242 V DC	$\geq 0.1 U_s$	0.9 W	54000 Ω	$\pm 10\%$
AC coils	24 V AC	50 / 60 Hz	19.2 V AC	26.4 V AC	$\geq 0.2 U_s$	1.6 VA	158 Ω	$\pm 10\%$
	48 V AC	50 / 60 Hz	38.4 V AC	52.8 V AC	$\geq 0.2 U_s$	1.6 VA	640 Ω	$\pm 10\%$
	60 V AC	50 / 60 Hz	48.0 V AC	66.0 V AC	$\geq 0.2 U_s$	1.6 VA	930 Ω	$\pm 10\%$
	110 V AC	50 / 60 Hz	88 V AC	121 V AC	$\geq 0.2 U_s$	1.6 VA	3450 Ω	$\pm 10\%$
	120 V AC	50 / 60 Hz	96 V AC	132 V AC	$\geq 0.2 U_s$	1.6 VA	3770 Ω	$\pm 10\%$
	230 V AC	50 / 60 Hz	184 V AC	253 V AC	$\geq 0.2 U_s$	1.6 VA	16100 Ω	$\pm 10\%$

CR-U range

	Rated control supply voltage U_s	Rated frequency	Make voltage (at 20 °C)	Maximum voltage (at 55 °C)	Break voltage	Rated power	Coil resistance (at 20 °C)	Tolerance of coil resistance
DC coils	12 V DC	-	9.6 V DC	13.2 V DC	$\geq 0.1 U_s$	1.5 W	110 Ω	$\pm 10\%$
	24 V DC	-	19.2 V DC	26.4 V DC	$\geq 0.1 U_s$	1.5 W	430 Ω	$\pm 10\%$
	48 V DC	-	38.4 V DC	52.8 V DC	$\geq 0.1 U_s$	1.5 W	1750 Ω	$\pm 10\%$
	110 V DC	-	88.0 V DC	121.0 V DC	$\geq 0.1 U_s$	1.5 W	9200 Ω	$\pm 10\%$
	125 V DC	-	96.0 V DC	132.0 V DC	$\geq 0.1 U_s$	1.5 W	11000 Ω	$\pm 10\%$
	220 V DC	-	176.0 V DC	242.0 V DC	$\geq 0.1 U_s$	1.5 W	37000 Ω	$\pm 10\%$
AC coils	24 V AC	50 / 60 Hz	19.2 V AC	26.4 V AC	$\geq 0.15 U_s$	2.8 VA (50 Hz) 2.5 VA (60 Hz)	75 Ω	$\pm 10\%$
	48 V AC	50 / 60 Hz	38.4 V AC	52.8 V AC	$\geq 0.15 U_s$	2.8 VA (50 Hz) 2.5 VA (60 Hz)	305 Ω	$\pm 10\%$
	60 V AC	50 / 60 Hz	48.0 V AC	66.0 V AC	$\geq 0.15 U_s$	2.8 VA (50 Hz) 2.5 VA (60 Hz)	475 Ω	$\pm 10\%$
	110 V AC	50 / 60 Hz	88.0 V AC	121.0 V AC	$\geq 0.15 U_s$	2.8 VA (50 Hz) 2.5 VA (60 Hz)	1700 Ω	$\pm 10\%$
	120 V AC	50 / 60 Hz	96.0 V AC	132.0 V AC	$\geq 0.15 U_s$	2.8 VA (50 Hz) 2.5 VA (60 Hz)	1910 Ω	$\pm 10\%$
	230 V AC	50 / 60 Hz	184.0 V AC	253.0 V AC	$\geq 0.15 U_s$	2.8 VA (50 Hz) 2.5 VA (60 Hz)	7080 Ω	$\pm 10\%$

Pluggable interface relays

Technical data

Type		CR-P...1	CR-P...2	CR-M...2	CR-M...3	CR-M...4	CR-U...2	CR-U...3
Output circuit(s)		11-12/14	11-12/14 21-22/24	11-12/14 21-22/24	11-12/14 21-22/24 31-32/34	11-12/14 21-22/24 31-32/34 41-42/44	11-12/14 31-32/34	11-12/14 21-22/24 31-32/34
Kind of output		Relay, 1 c/o	Relay, 2 c/o	Relay, 2 c/o	Relay, 3 c/o	Relay, 4 c/o	Relay, 2 c/o	Relay, 3 c/o
Contact material		AgNi	AgNi AgNi/Au 5 µm	AgNi	AgNi	AgNi AgNi/Au 5 µm	AgNi	
Rated operational voltage U _e (VDE 0110, IEC 60947-1)		250 V						
Minimum switching voltage		5 V		10 V	10 V	5 V	10 V	
Maximum switching voltage	DC	300 V DC		250 V DC				
	AC	440 V AC		250 V AC			440 V AC	
Minimum switching current		5 mA (AgNi)	2 mA (AgNi/Au)	5 mA (AgNi)	5 mA (AgNi)	2 mA (AgNi/Au)	5 mA	
Rated free air thermal current I _{th}		16 A	8 A	12 A	10 A	6 A	10 A	
Rated operational current (IEC 60947-5-1)	AC12 (resistive) 230 V	16 A	8 A	12 A	10 A	6 A	10 A	
	AC15 (inductive) 230 V	1.5 A	1.5 A	1.5 A	1.5 A	1 A	1.5 A	
	AC15 (inductive) 120 V	3 A						
	DC12 (resistive) 24 V	16 A	8 A	12 A	10 A	6 A	10 A	
	DC13 (inductive) 24 V	2.5 A	2 A	2.5 A	2.5 A	2 A	2 A	
	DC13 (inductive) 120 V	0.22 A						
	DC13 (inductive) 250 V	0.1 A						
AC rating (UL 508)	Utilization category (pilot duty) (Contact rating code designation)	B300		B300				B300
	max. rated operational voltage	300 V AC		300 V AC				300 V AC
	Max. continuous thermal current at utilization category	5 A		5 A	5 A	2.5 A		5 A
	Max. making / breaking apparent power at utilization category	3600 / 360 VA		3600 / 360 VA		1800 / 180 VA		3600/360 VA
	Utilization category (resistive) (CSA22.2 No.14....)	16 A, 250 V AC	8 A, 250 V AC	10 A, 250 V AC 12 A, 150 V AC	6 A, 250 V AC 10 A, 150 V AC	5 A, 250 V AC 10 A, 150 V AC	10 A, 250 V AC	
	DC rating * (UL 508; NEMA ICS-5)	Utilization category (pilot duty) (Contact rating code designation)	R300					
	Max. rated operational voltage	300 V DC						
	Max. continuous thermal current at utilization category	1 A						
	Max. making / breaking apparent power at utilization category	28 VA						
	Utilization category (resistive) (CSA22.2 No.14....)		10 A, 24 V DC				10 A, 28 V DC	
Maximum making (inrush) current		30 A		24 A	20 A	12 A	20 A	
Minimum switching power		0.3 W (AgNi), 0.05 W (AgNi/Au)		0.3 W (AgNi), 0.1 W (AgNi/Au)			0.3 W	
Maximum switching (breaking) power	AC1 (resistive)	4000 VA	2000 VA	3000 VA	2500 VA	1500 VA	2500 VA	
Contact resistance		≤ 100 mΩ						
Maximum operating frequency	rated load AC-1	600 switching cycles/h		1200 switching cycles/h			12000 switching cycles/h	
	without load	72000 switching cycles/h		18000 switching cycles/h			12000 switching cycles/h	
Mechanical lifetime		> 3 x 10 ⁷ switching cycles		> 2 x 10 ⁷ switching cycles				
Electrical lifetime	electrical AC1 (resistive)	> 0.7 x 10 ⁵ switching cycles (16 A, 250 V)	> 10 ⁵ switching cycles (8 A, 250 V)	(12 A, 250 V)	(10 A, 250 V)	(6 A, 250 V)	> 10 ⁵ switching cycles (10 A, 250 V)	
		cos φ see reduction factor F						
			typ. 7 ms		typ. 13 ms (DC), 10 ms (AC)			typ. 18 ms (DC), 12 ms (AC)
Release time		typ. 3 ms		typ. 3 ms (DC), 8 ms (AC)			typ. 7 ms (DC), 10 ms (AC)	
Isolation data								
Rated insulation voltage		400 V AC		250 V AC				
Insulation class		C250 / B400		C250 / B250			C250	
Rated impulse withstand voltage U _{imp}	between coil and contacts	5 kV AC		2.5 kV AC				
	between open contacts	1 kV AC		1.5 kV AC				
	between c/o (SPDT) contacts		2.5 kV AC	2.5 kV AC		≥ 2 kV AC	2 kV AC	

* Those ratings are based on different type tests but they are not covered by the cULus or CSA approvals.

Pluggable interface relays

Technical data, Load limit curves

Type		CR-P...1	CR-P...2	CR-M...2	CR-M...3	CR-M...4	CR-U...2	CR-U...3
Clearance	between coil and contacts	≥ 10 mm		≥ 2.5 mm		≥ 1.6 mm	≥ 3 mm	
Creepage distance	between coil and contacts	≥ 10 mm		≥ 4 mm		≥ 3.2 mm	≥ 4.2 mm	
Overvoltage category		III		III		II	III	
Pollution degree		3		3		2	3	
General data								
Dimensions (W x H x D) when mounted		12.7 x 29 x 15.7 mm		21.2 x 27.5 x 35.6 mm			35 x 35 x 54.4 mm	
Weight		14 g (0.031 lb)		35 g (0.077 lb)			83 g (0.18 lb)	
Mounting		on socket (see accessories)						
Mounting position		any						
Degree of protection		IP 67		IP 40				
Electrical connection								
Connection		by socket						
Environmental data								
Ambient temperature range	operation	DC: -40...+85 °; AC: -40...+70 °C		DC: -40...+70 °; AC: -40...+55 °C				
	storage	-40 ... +85 °C						
Vibration resistance 10-150 Hz	n/o contact	10 g		5 g			5 g	
	n/c contact	10 g		5 g			5 g	
Shock resistance	n/o contact	30 g		20 g			10 g	
	n/c contact	30 g		20 g			10 g	
Standards								
Product standard		EN 61810-1, EN 60255-23 IEC 60664-1		EN 60810-1, EN 60255-23, IEC 61810-7			EN 60255-1-00	
Low Voltage Directive		2006/95/EC						

Approvals see page 5/6.

Load limit curves - Maximum switching power at resistive DC load

CR-P with 1 c/o contact

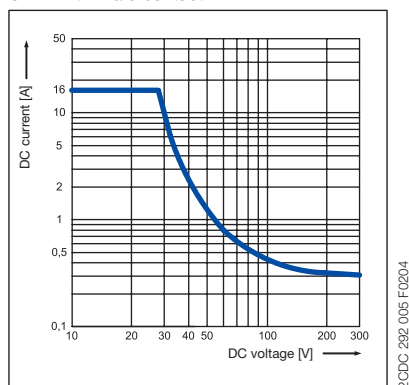

CR-P with 2 c/o contacts

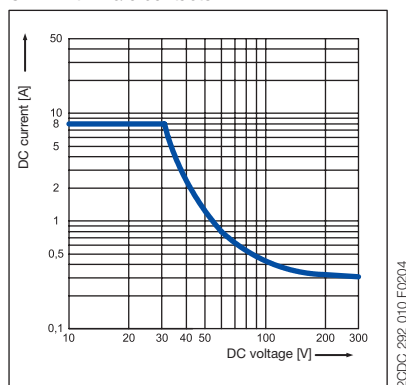

CR-U with 2 and 3 c/o contacts

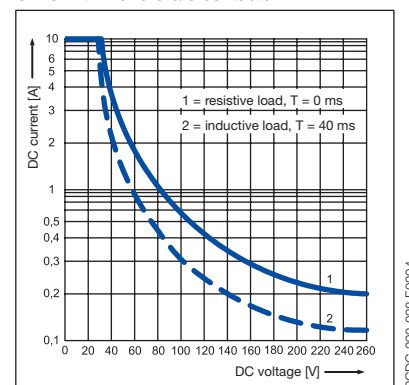

CR-M with 2 c/o contacts

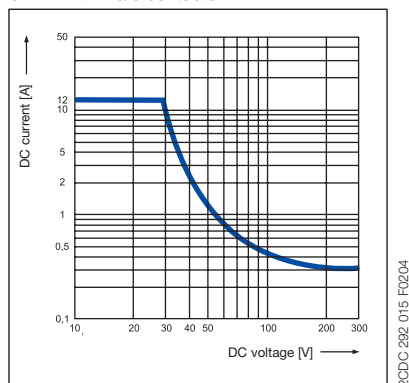

CR-M with 3 c/o contacts

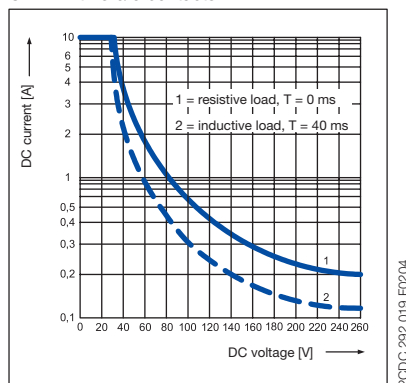

CR-M with 4 c/o contacts

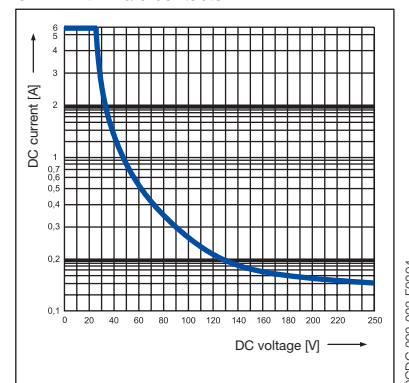

Pluggable interface relays

Load limit curves

Load limit curves - Electrical lifetime at resistive AC load

5

CR-P with 1 c/o contact

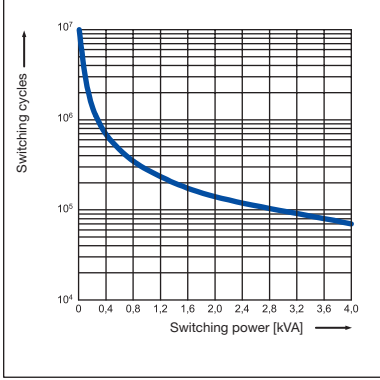

CR-P with 2 c/o contacts

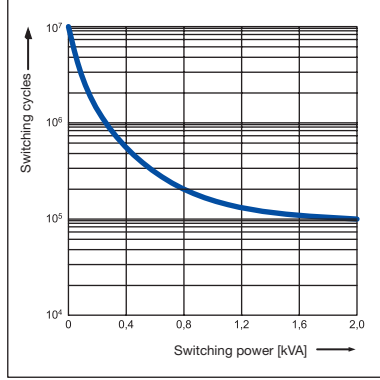

CR-U with 2 and 3 c/o contacts

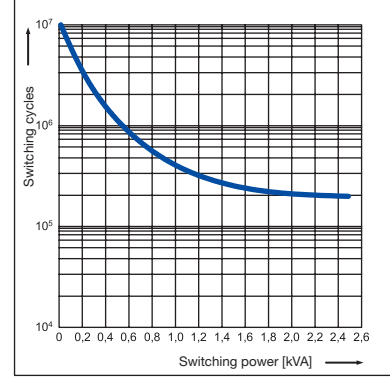

CR-M with 2 c/o contacts

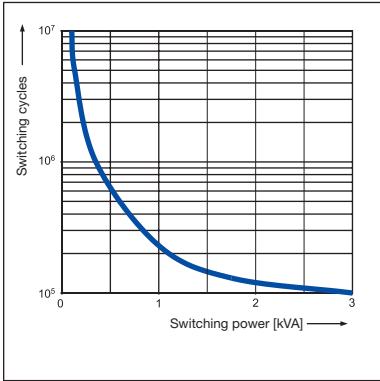

CR-M with 3 c/o contacts

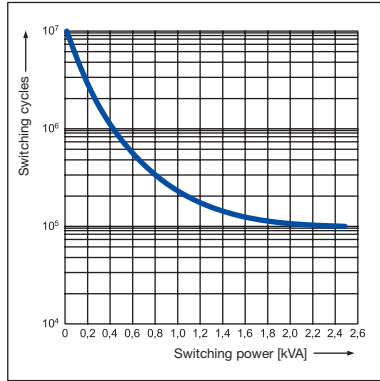

CR-M with 4 c/o contacts

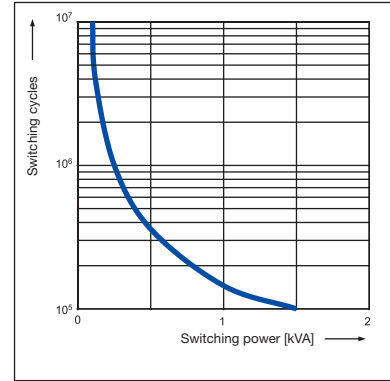

Reduction factor F at inductive AC load

CR-P

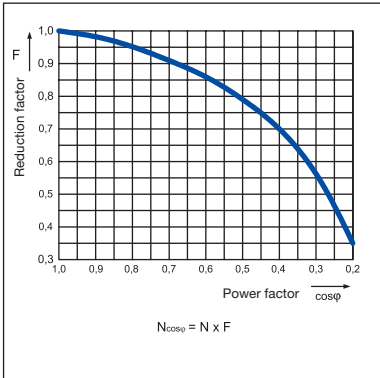

CR-M

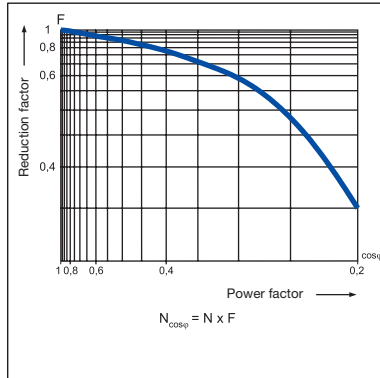

CR-U

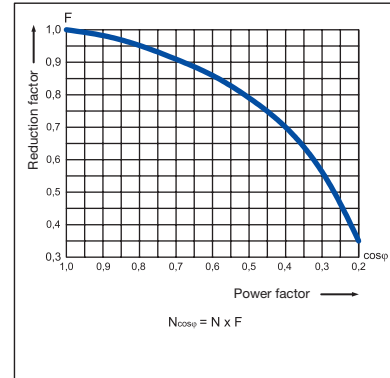

Pluggable interface relays

Connection diagrams

Connection diagrams

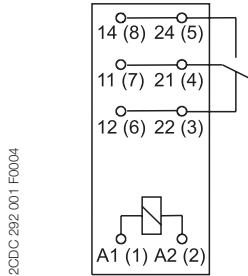

CR-P with 1 c/o contact

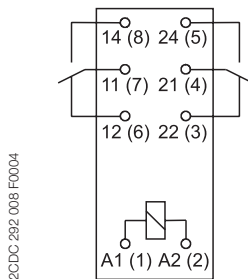

CR-P with 2 c/o contacts

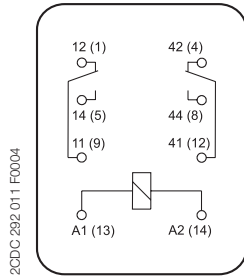

CR-M with 2 c/o contacts

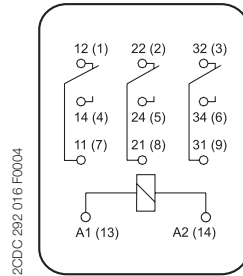

CR-M with 3 c/o contacts

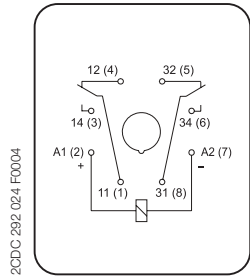

CR-U with 2 c/o contacts

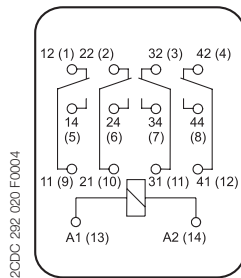

CR-M with 4 c/o contacts

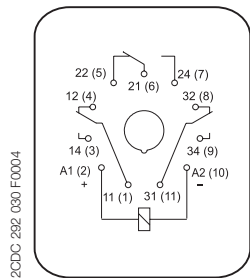

CR-U with 3 c/o contacts

Dimensional drawings

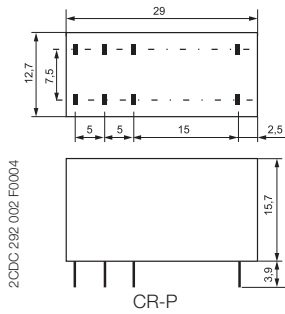

CR-P

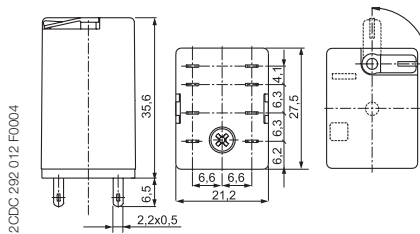

CR-M with 2 c/o contacts

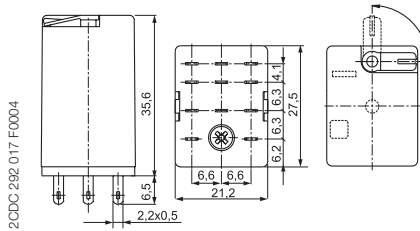

CR-M with 3 c/o contacts

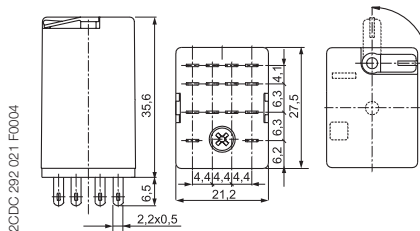

CR-M with 4 c/o contacts

Dimensions in mm and inches

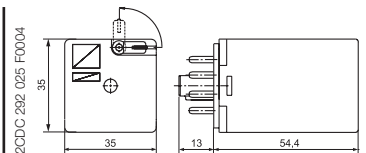

CR-U with 2 c/o contacts

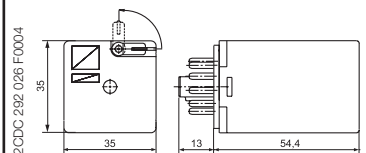

CR-U with 3 c/o contacts

Pluggable interface relays

Connection diagrams

Dimensional drawings

Sockets for screw connection

Dimensions in mm and inches

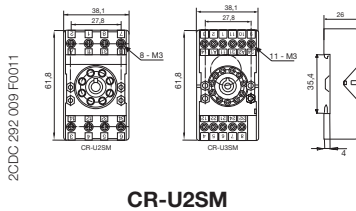
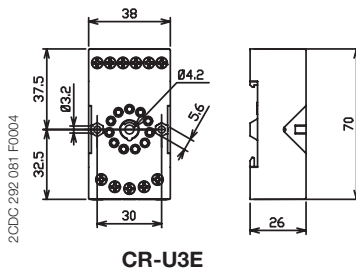
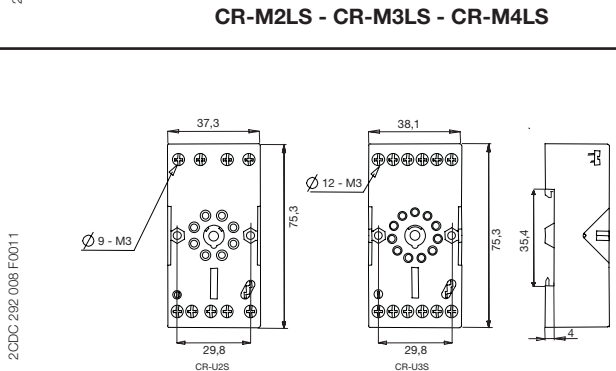
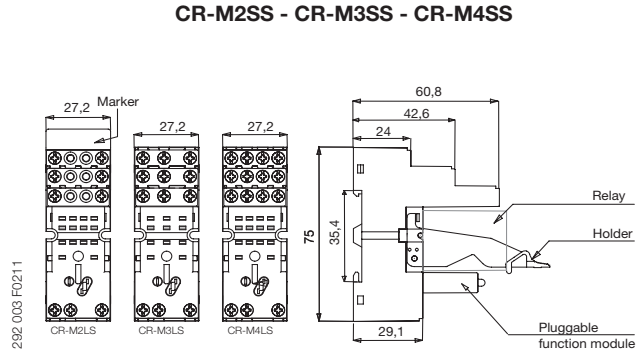
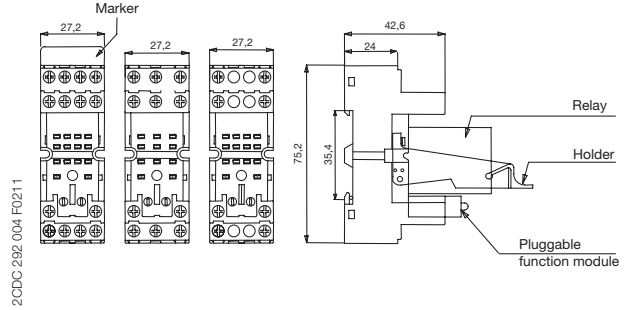
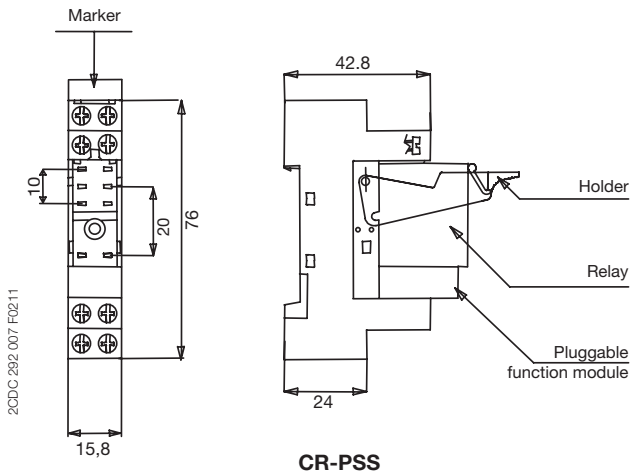
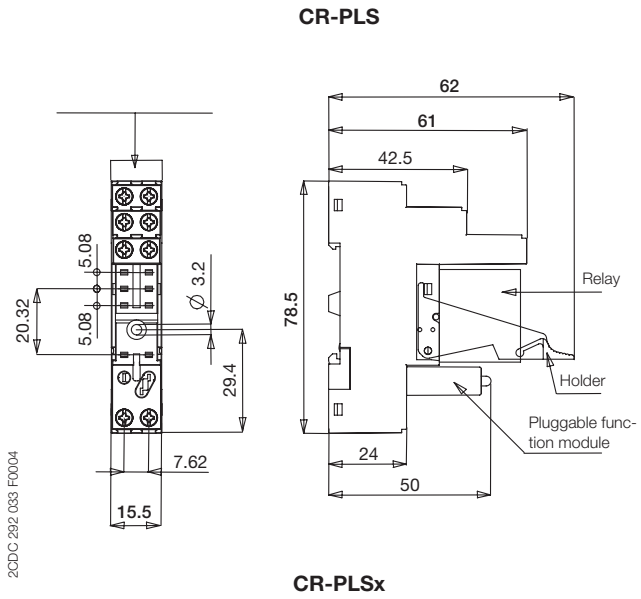
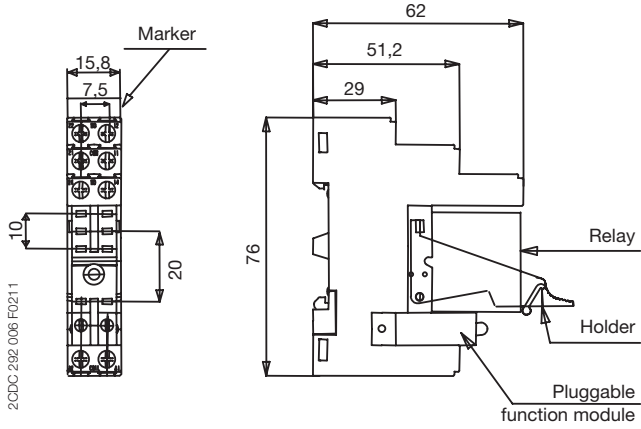

Pluggable interface relays

Connection diagrams

Dimensional drawings

Dimensions in mm and inches

Sockets for spring connection

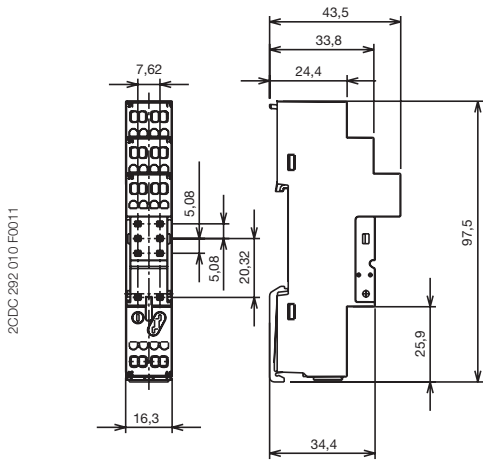

CR-PLC

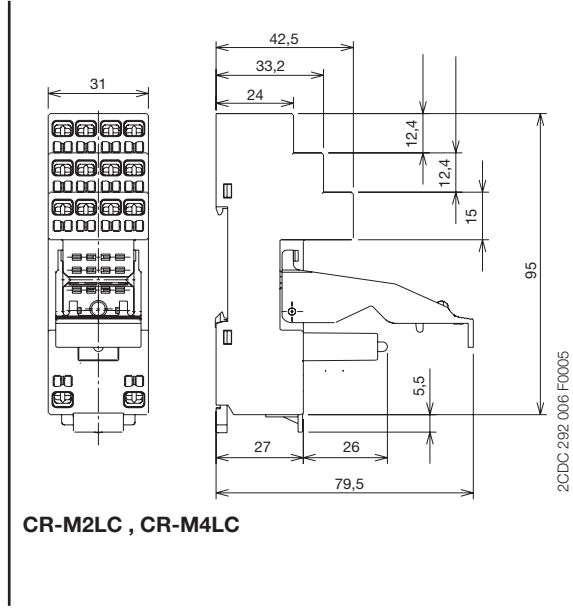

CR-M2LC , CR-M4LC

Jumper

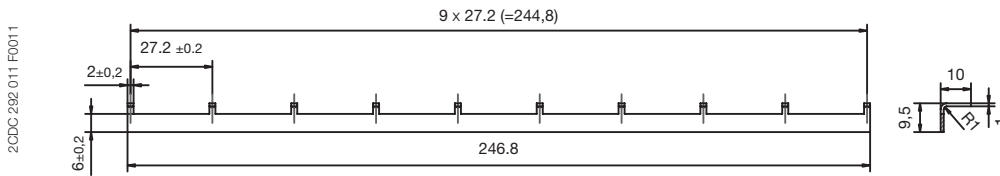

CR-PJ

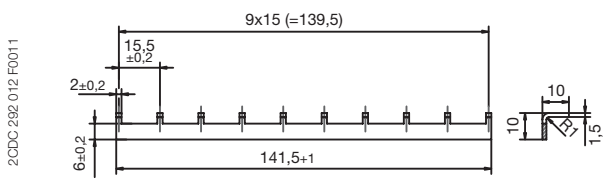

CR-MJ

Interface relays and optocouplers R500 / R600 range

Product group picture

5

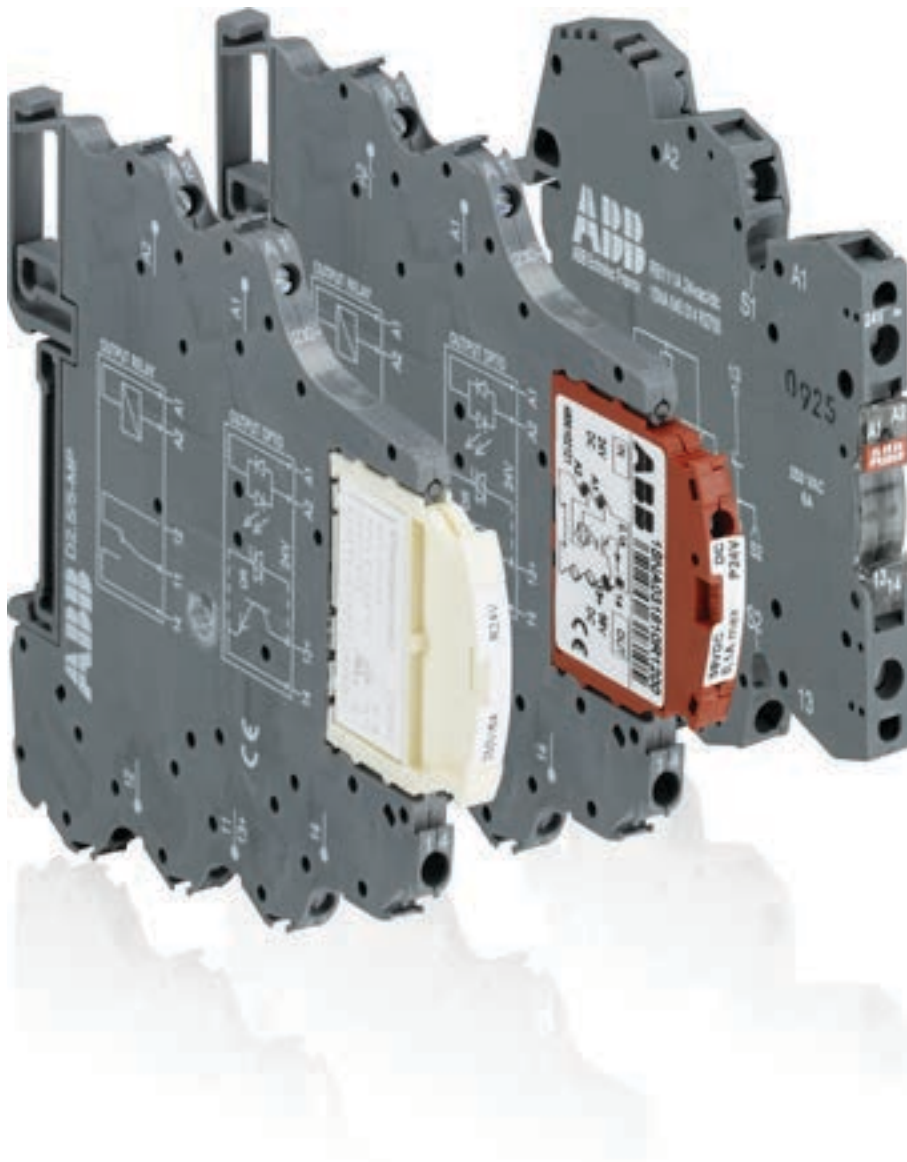

Interface relays and optocouplers R500 / R600 range

Table of contents

Interface relays and optocouplers R500/R600 range	
Table of contents	5/22
Benefits and advantages	5/23
Type designators	5/24
Interface relays and optocouplers R500 range	5/25
Table of contents	5/26
Interface relays R500 range	5/27
Table of contents	5/28
Selection	5/29
Ordering details	5/30
Technical information	5/31
Notes	5/32
Optocouplers R500 range	5/33
Table of contents	5/34
Selection	5/35
Ordering details	5/36
Connection diagrams	5/37
Technical data	5/38
Interface relays and optocouplers R600 range	5/45
Table of contents	5/46
Interface relays R600 range	5/47
Table of contents	5/48
Benefits and advantages	5/49
Selection	5/51
Ordering details	5/53
Connection diagrams	5/55
Technical data	5/56
General technical data	5/61
Dimensional drawings, Load limit curves	5/62
Optocouplers R600 range	5/63
Table of contents	5/64
Selection	5/65
Ordering details	5/67
Connection diagrams	5/68
Technical data	5/69

Interface relays and optocouplers R500 / R600 range

Benefits and advantages



2C2DC 281 012 F0013

R500 series

It is our range offering pluggable functions

- Spacing : 5.08 mm (the smallest in the market)
- Wire size : 2.5 mm² (4 mm² solid)
- Contact type : 1 SPDT from 10 mA to 6 A / 250 V



2C2DC 281 024 F0013

R600 series

Standard range in screw clamp or spring clamp versions

- Spacing : 6 mm or 12 mm
- Wire size : 2.5 mm² (4 mm² solid wire)
- Contact type : 1 NO, 1 NC, 1 SPDT, 1 DPDT from 1 mA to 8 A / 250 V

In today's automation systems, PLCs are the core of industry. They link sensors and actuators to the process, which are connected to the PLC via conventional wires.



However these PLCs are not completely isolated from the industrial environment, hence over voltage picks and transient currents can affect their operating functions. And additionally, their application field is often limited to 24 VDC / 100 mA.

So, with the aim to adapt application voltage and/or current and provide as well the right electrical isolation to the PLC, it is recommended to install per I/O the right interface providing both voltage-current level adaptation and isolation protection.

This interfacing is possible thanks to ABB's relays and optocouplers ranges, which offer wide adaptation in both voltage (from 5 to 400 V) and current (from 10-7 to 16 A) as well as high isolation between input and output from 2 to 4 KV.

Interface relays and optocouplers R500 / R600 range

Type designators

SERIES	CODE	NB OF RELAYS	CONTACT TYPE	NB OF CONTACTS PER RELAY	PARTICULARITIES			
R 600 	<table border="1"><tr><td>R</td><td>B</td></tr></table>	R	B	<input type="checkbox"/>	<input type="checkbox"/>	<input type="checkbox"/>	<input type="checkbox"/>	
R	B							
R 600 	<table border="1"><tr><td>R</td><td>B</td><td>R</td></tr></table>	R	B	R	<input type="checkbox"/>	<input type="checkbox"/>	<input type="checkbox"/>	<input type="checkbox"/>
R	B	R						
R 500	<table border="1"><tr><td>D</td><td>2,5/5</td><td>R</td></tr></table>	D	2,5/5	R	<input type="checkbox"/>	<input type="checkbox"/>	<input type="checkbox"/>	<input type="checkbox"/>
D	2,5/5	R						
		↓ 1	↓ 0 1 2	↓ 1 2	↓ None A B R I			

Description of contact types



Features

None Input voltage DC
A Input voltage AC/DC

R



RC circuit protection :
 - Input protection against leakage current



- Increases relay contacts life

I Switch to force the coil for maintenance and/or installation purposes

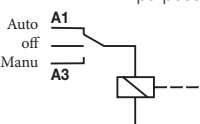

Auto A1
 off
 Manu A3

Interface relays and optocouplers R500 range

Product group picture

5

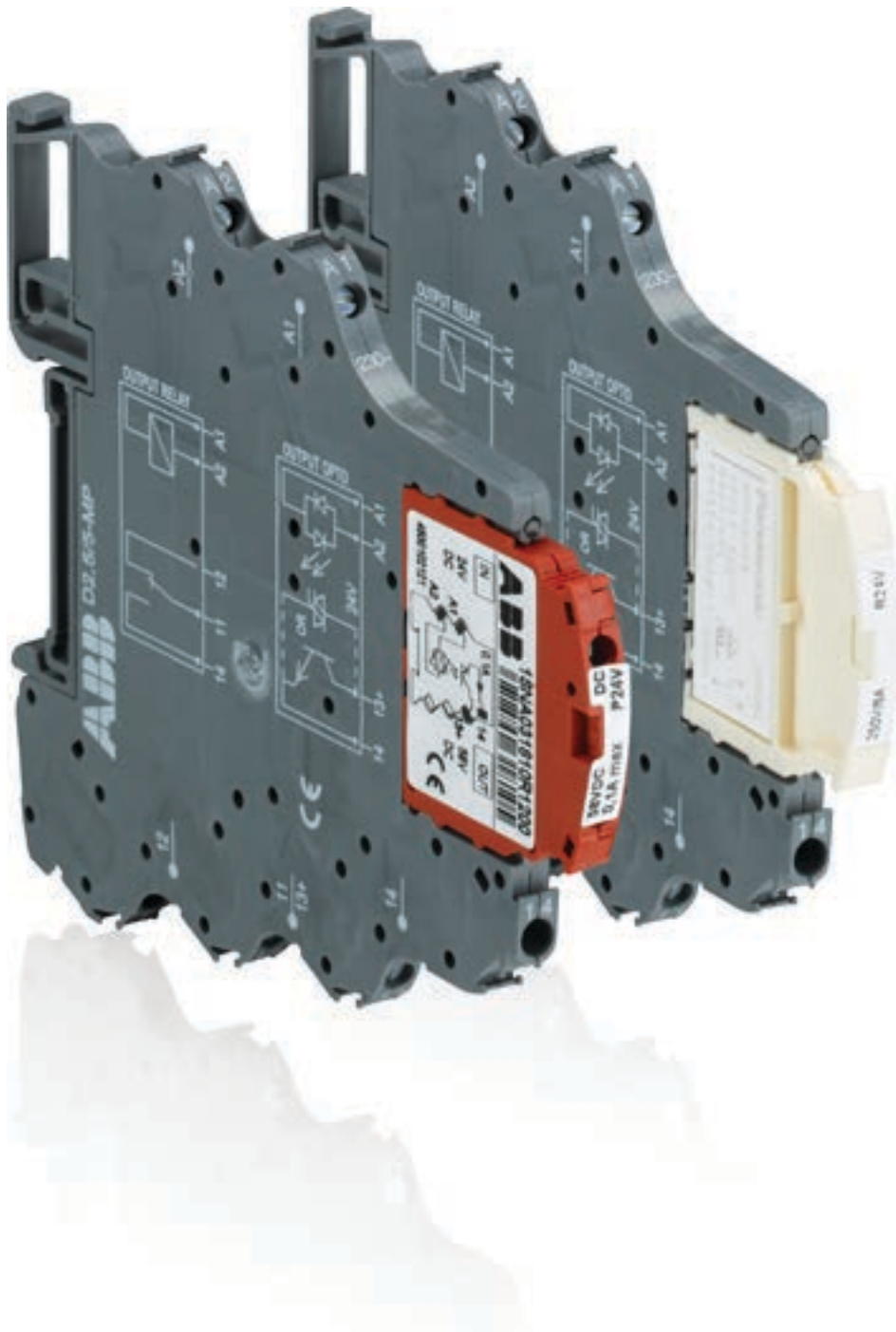

Interface relays and optocouplers R500 range

Table of contents

Interface relays and optocouplers R500 range	
Product group picture	5/25
Table of contents	5/26
Interface relays R500 range	5/27
Product group picture	5/27
Table of contents	5/28
Selection	5/29
Ordering details	5/30
Technical information	5/31
Optocouplers R500 range	5/33
Product group picture	5/33
Table of contents	5/34
Selection	5/35
Ordering details	5/36
Connection diagrams	5/37
Technical data	5/38

Interface relays R500 range

Product group picture

5

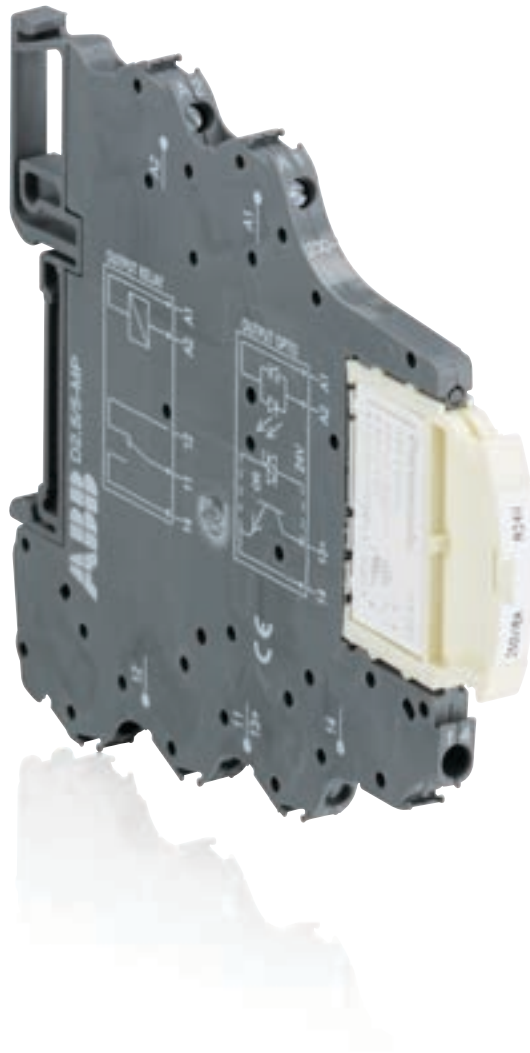

Interface relays R500 range

Table of contents

Interface relays R500 range	
Table of contents	5/28
Selection	5/29
Ordering details	5/30
Technical information	5/31
Notes	5/32

Interface relays R500 range

Selection

Type	Order number
D 2,5/5-R121-24VDC	1SNA 645 047 R0000
D 2,5/5-R121L-24VDC	1SNA 645 547 R0200
D 2,5/5-R121AL-24VAC/DC	1SNA 645 021 R2600
D 2,5/5-R121AL-48VAC/DC	1SNA 645 521 R2000
D 2,5/5-R121BL-110VAC	1SNA 645 049 R1200
D 2,5/5-R121BL-230VAC	1SNA 645 549 R1400

Input voltage	
24 V DC	■ ■ ■
48 V DC	■
24 V AC	■
48 V AC	■
110 V AC	■
230 V AC	■

Output rating	
10 mA - 6 A	■ ■ ■ ■ ■ ■

Output contacts	
c/o	1 1 1 1 1 1

Type	
with LED	■ ■ ■ ■ ■
without LED	■

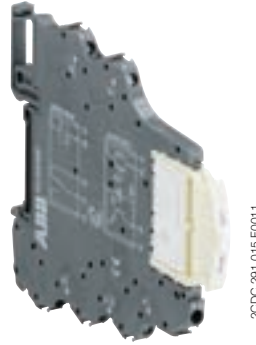

2CDC 281 015 F0011

R500 series

Characteristics

- Spacing : 5.08 mm (the smallest in the market)
- Wire size : 2.5 mm² (4 mm² solid)
- Contact type : 1 SPDT from 10 mA to 6 A / 250 V

Interface relays R500 range

Ordering details

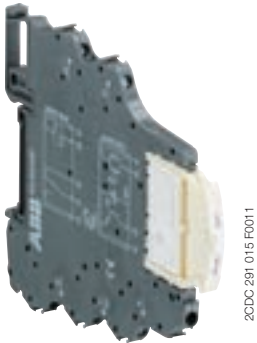

2CDC 291 015 R0011

R500

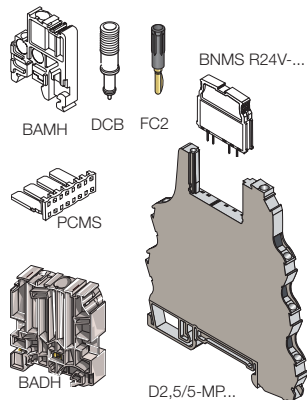

Description of R500 Relay	Type	Order code	Price	Pkg qty	Weight (1 pce) kg (lb)
Relay module 1 SPDT high level	D 2,5/5-R121-24VDC	1SNA607217R0200		10	0.032 (0.071)
	D 2,5/5-R121L-24VDC	1SNA607201R1300			
Relay module with LED 1 SPDT high level	D 2,5/5-R121AL-24VAC/DC	1SNA607231R0000			
	D 2,5/5-R121AL-48VAC/DC	1SNA607232R0100			
	D 2,5/5-R121BL-110VAC	1SNA607264R1100			
	D 2,5/5-R121BL-230VAC	1SNA607265R1200			

R500 Accessories	Type	Order code	Price	Pkg qty	Weight (1 pce) kg (lb)
High end stop	BAMH 9,1 mm	1SNA114836R0000		50	
	BAMH V0 9,1 mm	1SNA194836R0100			
	BADH 12 mm	1SNA116900R2700			
Comb type jumper bar 2 to 22 poles		consult us			
Jumper bar 10 poles grey □	PCMS V0	1SNA205523R2200		8	
Relay / Opto base	D 2,5/5-MP	1SNA607224R0100		10	0.028 (0.062)
Relay / Opto base with LED 24 VDC	D 2,5/5-MP-24VDC	1SNA607222R0700			
Relay / Opto base with LED 24 VAC/VDC	D 2,5/5-MP-24VAC/DC	1SNA607260R2100			
Relay / Opto base with LED 48 VAC/VDC	D 2,5/5-MP-48VAC/DC	1SNA607261R1600			
Relay / Opto base with LED 110 VAC	D 2,5/5-MP-110VAC	1SNA607266R1300			
Relay / Opto base with LED 230 VAC	D 2,5/5-MP-230VAC	1SNA607267R1400			
Plug relay 24 V 1 SPDT 10 mA to 6 A	BNMS R24V-1	1SNA031820R1400		4	
Plug relay 24 V 1 SPDT 1 mA to 6 A	BNMS R24V-2	1SNA031847R1300			
Test device blue ■	DCB ¹⁾	1SNA105028R2100		10	
Test plug DIA. 2 mm	FC2	1SNA007865R2600			
Marking method	RC55	see marking			

¹⁾ Only on top decks

Connection diagrams

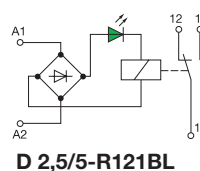
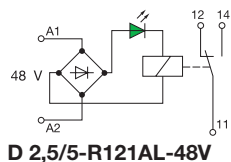
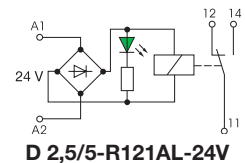
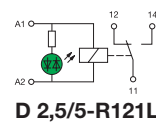
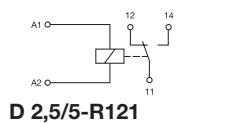

Interface relays R500 range

Technical information

Technical data

Relay : 1 SPDT high level with contact 10 mA to 6 A - 5.08mm 0.200" spacing

	D 2.5/5-R121	D 2.5/5-R121L	D 2.5/5-R121AL				D 2.5/5-R121BL	
Relay characteristics coil								
Rated voltage: +20%, -15% on DC ; 10%, -10% on AC	24 V DC	24 V DC	24 V AC	24 V DC	48 V AC	48 V DC	110 V AC	230 V AC
Frequency			50/60 Hz		50/60 Hz		50/60 Hz	50/60 Hz
Power	0.17 W	0.3 W	0.35 W	0.35 W	0.44 W	0.47 W	1.08 W	2.13 W
Rated current	7 mA	12 mA	12.4 mA	10 mA	7.6 mA	6.8 mA	8.4 mA	8 mA
Drop-out voltage at 20°C	2.4 V	2.4 V	4.8 V	4.8 V	10 V	10 V	25 V	45 V
Status device	green LED							

Relay characteristics contact

Type	1 SPDT								
Voltage switching range min./max.	12 V / 250 V AC								
Current switching range min./max.	10 mA / 6 A								
Load switching range	AC1 min./max.	0.6 VA / 1500 VA (ohmic load)							
	DC1 min./max.	0.6 W / 140 W							
Number of on-load operations	10 ⁵ on AC15								
Number of off-load operations	10 x 10 ⁷								
Operation speed	F	5 ms	5 ms	5 ms	5 ms	5 ms	5 ms	6 ms	7 ms
	O	8 ms	8 ms	15 ms	15 ms	15 ms	15 ms	15 ms	15 ms
Insulation coil / contact	4000 V RMS								
Resistance to shock coil / contact	4000 V RMS								
Insulation contact / contact	1000 V RMS								
Ambient temperature	storage	-40 °C to -80 °C							
	operating	See derating curves							

Other characteristics

Body material	grey	UL 94 V0
Wire size	Solid wire	0.2 - 4 mm ² (24-12 AWG)
	Stranded wire	0.22 - 2.5 mm ² (24-12 AWG)
Rated wire size	2.5 mm ² (12 AWG)	
Wire stripping length	10 mm (0.394 in)	
Recommended screwdriver	3.5 mm (0.137 in)	
Protection	IP20 NEMA1	
Recommended torque	0.4-0.6 Nm (3.5-5.3 lb.in)	
Approvals	cULus (pending) , CE	
Reference standards	CEI 947-7-1 / CEI 947-1 / CEI 1131-2 (in relevant parts) / CEI 60664-1 / CEM : IEC 1000-4-2, 3, 4, 5, 6.	

	DC12	AC12	DC13	AC15
24 V	6 A	6 A	1 A	3 A
110/120 V	0,3 A	6 A	0,2 A	3 A
220/230 V	0,2 A	6 A	0,1 A	3 A

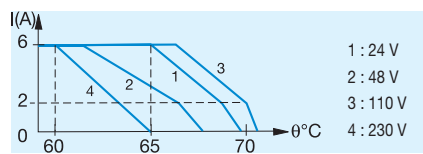
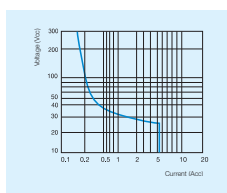

D 2,5/5-R121

Dimensional drawings

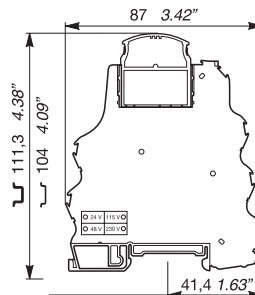

Optocouplers R500 range

Product group picture

5



Optocouplers R500 range

Table of contents

Optocouplers R500 range	
Product group picture	5/33
Table of contents	5/34
Selection	5/35
Ordering details	5/36
Connection diagrams	5/37
Technical data	5/38
Notes	5/44

Optocouplers R500 range Selection

Type	Order number
D 2,5/5-OBIC-0030-5VDC	1SNA 607 274 R1300
D 2,5/5-OBIC-0030-24VDC	1SNA 607 210 R1700
D 2,5/5-OBIC-0030-48VDC	1SNA 607 211 R0400
D 2,5/5-OBIC-0030-125VDC	1SNA 607 275 R1400
D 2,5/5-OBIA-0030-24VAC	1SNA 607 212 R0500
D 2,5/5-OBIA-0030-48VAC	1SNA 607 213 R0600
D 2,5/5-OBIA-0030-115VAC	1SNA 607 214 R0700
D 2,5/5-OBIA-0030-230VAC	1SNA 607 215 R0000
D 2,5/5-OBOC-0100-5VDC	1SNA 607 203 R1500
D 2,5/5-OBOC-0100-24VDC	1SNA 607 204 R1600
D 2,5/5-OBOC-0100-48VDC	1SNA 607 205 R1700
D 2,5/5-OBOC-1000-5VDC	1SNA 607 206 R1000
D 2,5/5-OBOC-1000-24VDC	1SNA 607 207 R1100
D 2,5/5-OBOC-1000-24VAC/DC	1SNA 607 250 R2700
D 2,5/5-OBOC-1000-48VAC/DC	1SNA 607 251 R1400
D 2,5/5-OBOC-1000-110VAC	1SNA 607 270 R2300
D 2,5/5-OBOC-1000-230VAC	1SNA 607 271 R1000
D 2,5/5-OBOC-2000-5VDC	1SNA 607 208 R2200
D 2,5/5-OBOC-2000-24VDC	1SNA 607 209 R2300
D 2,5/5-OBOC-2000-24VAC/DC	1SNA 607 255 R1000
D 2,5/5-OBOC-2000-48VAC/DC	1SNA 607 256 R1100
D 2,5/5-OBOC-2000-110VAC	1SNA 607 272 R1100
D 2,5/5-OBOC-2000-230VAC	1SNA 607 273 R1200
D 2,5/5-OB0A-1000-24VDC	1SNA 607 238 R1700
D 2,5/5-OB0A-1000-24VAC/DC	1SNA 607 240 R2500
D 2,5/5-OB0A-1000-48VAC/DC	1SNA 607 241 R1200
D 2,5/5-OB0A-1000-110VAC	1SNA 607 268 R2500
D 2,5/5-OB0A-1000-230VAC	1SNA 607 269 R2600

Input voltage	
5 V DC	■
24 V DC	■
48 V DC	■
125 V DC	■
24 V AC	■
48 V AC	■
110 V AC	■
115 V AC	■
230 V AC	■

Output rating	
30 mA	■
100 mA	■
2 A	■
1 A	■

Output voltage	
30 V DC	■
58 V DC	■
253 V AC	■

Type	
input optocoupler	■
output optocoupler	■

Optocouplers R500 range

Ordering details

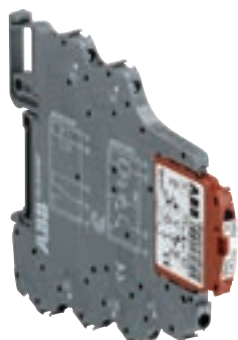

2CDC291 002 F01/3

Description of R600 Optocoupler	Type	Order code	Price	Pkg qty	Weight (1 pce) kg (lb)
Optocoupler module 30 mA/DC Transistor	D 2,5/5-OBIC-0030-5VDC	1SNA607274R1300		1	0.032 (0.071)
	D 2,5/5-OBIC-0030-24VDC	1SNA607210R1700			
	D 2,5/5-OBIC-0030-48VDC	1SNA607211R0400			
Optocoupler module 30 mA/DC Transistor	D 2,5/5-OBIC-0030-125VDC	1SNA607275R1400		1	0.032 (0.071)
	D 2,5/5-OBIA-0030-24VAC	1SNA607212R0500			
	D 2,5/5-OBIA-0030-48VAC	1SNA607213R0600			
	D 2,5/5-OBIA-0030-115VAC	1SNA607214R0700			
Optocoupler module 100 mA/DC Transistor	D 2,5/5-OBIA-0030-230VAC	1SNA607215R0000		1	0.032 (0.071)
	D 2,5/5-OBOC-0100-5VAC	1SNA607203R1500			
	D 2,5/5-OBOC-0100-24VDC	1SNA607204R1600			
Optocoupler module 1 A/DC MOS-FET	D 2,5/5-OBOC-0100-48VAC	1SNA607205R1700		1	0.04 (0.088)
	D 2,5/5-OBOC-1000-5VDC	1SNA607206R1000			
	D 2,5/5-OBOC-1000-24VDC	1SNA607207R1100			
	D 2,5/5-OBOC-1000-24VAC/DC	1SNA607250R2700			
	D 2,5/5-OBOC-1000-48VAC/DC	1SNA607251R1400			
	D 2,5/5-OBOC-1000-110VAC	1SNA607270R2300			
Optocoupler module 2 A/DC MOS-FET	D 2,5/5-OBOC-1000-230VAC	1SNA607271R1000		1	0.04 (0.088)
	D 2,5/5-OBOC-2000-5VDC	1SNA607208R2200			
	D 2,5/5-OBOC-2000-24VDC	1SNA607209R2300			
	D 2,5/5-OBOC-2000-24VAC/DC	1SNA607255R1000			
Optocoupler module 1 A/AC Thyristor	D 2,5/5-OBOC-2000-48VAC/DC	1SNA607256R1100		1	0.04 (0.088)
	D 2,5/5-OBOC-2000-110VAC	1SNA607272R1100			
	D 2,5/5-OBOC-2000-230VAC	1SNA607273R1200			
	D 2,5/5-OBOA-1000-24VDC	1SNA607238R1700			
	D 2,5/5-OBOA-1000-24VAC/DC	1SNA607240R2500			
Optocoupler module 1 A/AC Thyristor	D 2,5/5-OBOA-1000-48VAC/DC	1SNA607241R1200		1	0.04 (0.088)
	D 2,5/5-OBOA-1000-110VAC	1SNA607268R2500			
	D 2,5/5-OBOA-1000-230VAC	1SNA607269R2600			

5

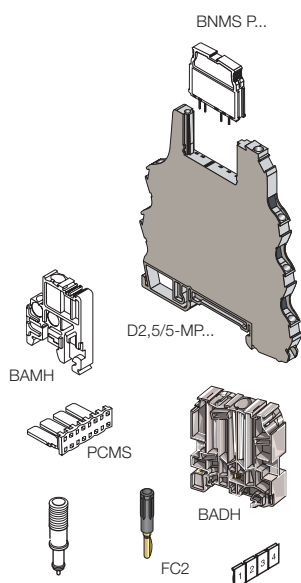

Description of Accessories	Type	Order code	Price	Pkg qty	Weight (1 pce) kg (lb)
High end stop	BAMH 9.1 mm	1SNA114836R0000		50	
	BAMH V0 9.1 mm	1SNA194836R0100			
	BADH 12 mm	1SNA116900R2700			
Comb type jumper bar 2 to 22 poles		consult us			
Jumper bar 10 poles grey	PCMS V0	1SNA205523R2200		8	
Input opto base	D 2.5-5-MP1	1SNA607223R0000		10	0.028 (0.062)
Plug OBIC 5 V white	BNMS T5V-1	1SNA031831R0300		4	
Plug OBIC 24 V white	BNMS T24V-1	1SNA031800R2100			
Plug OBIC 48 V white	BNMS T48V-1	1SNA031801R1600			
Plug OBIC 125 V white	BNMS T125V-1	1SNA031845R1100			
Test device blue	DCB (1)	1SNA105028R2100		10	
Test plug DIA 2 mm	FC2	1SNA105028R2100			
Marking method	RC55	see marking			

Optocouplers R500 range

Connection diagrams

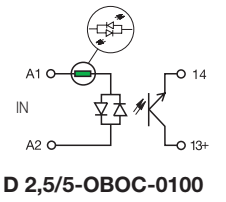
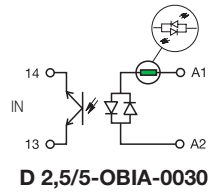
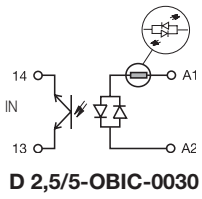

5

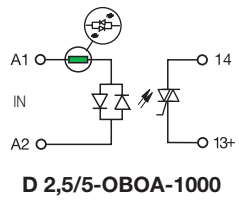
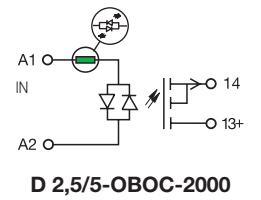
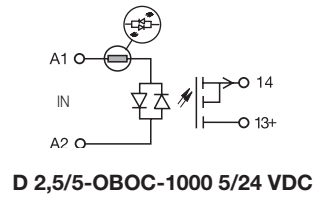
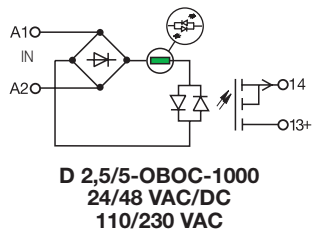



Optocouplers R500 range

Technical data

Technical data

Pluggable optocoupler : 5 to 58 V DC output / 30 mA - 5.08 mm 0.200" spacing

		D 2,5/5-OBIC-0030			
Input					
Input voltage		4.5 V to 5.5 VDC	19.2 V to 27.6 VDC	38.4 V to 55.2 VDC	93.5 V to 140 VDC
Input current		6 mA	5 mA	4.1 mA	3 mA
Pull-in voltage at Is=100%		3.5 V	12 V	21 V	50 V
Switching time C / O		20 μ s / 1.3 ms			
Operating frequency		400 Hz			
Permissible leakage current			1 mA	0.8 mA	
Output					
Output voltage		4.5 to 58 V DC			
Output current min.		0.5 mA			
Output current max.		30 mA			
Output leakage current at U _{max}		< 50 μ A			
Redidual voltage at I max and U rated	typical	2.3 V DC			
	max	2.7 V DC			
Frequency on inductive load					
Isolation Input / Output	input / Output	2500 V RMS			
Ambient temperature	storage	-40...+80 °C			
	operating	See derating curve			
Other characteristics					
Body material	grey	UL 94 V0			
Wire size	Solid wire	0.2 - 4 mm ² (24-12 AWG)			
	Stranded wire	0.22 - 2.5 mm ² (24-12 AWG)			
Rated wire size		2.5 mm ² (12 AWG)			
Wire stripping length		9 mm (0.354 in)			
Recommended screwdriver		3.5 mm (0.137 in)			
Protection		IP20 NEMA1			
Recommended torque		0.4-0.6 Nm (3.5-5.3 lb.in)			
Approvals		c  us (pending), 			
Reference standards		CEI 947-1 / CEI 947-1 / CEI 1131-2 (in relevant parts) / CEI 60664-1 / CEM : IEC 1000-4-2, 3, 4, 5, 6.			

5

Derating curve

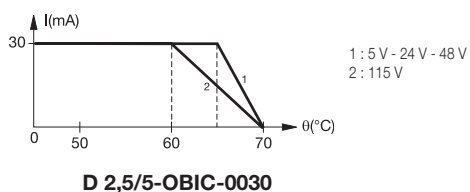

Dimensional drawings

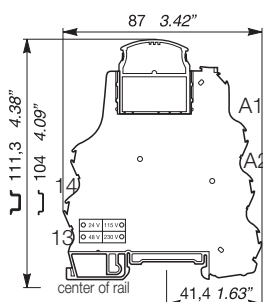

Optocouplers R500 range

Technical data

Technical data

Pluggable optocoupler : 5 to 58 V DC output / 30 mA - 5.08 mm 0.200" spacing

D 2,5/5-OBIA-0030

Input				
Input voltage	20.4 to 26.4 V AC	40.8 V to 52.8 V AC	98 V to 126.5 V AC	195.5 V to 253 V AC
Input current	8.5 mA	4.5 mA	8 mA	7 mA
Pull-in voltage at Is=100%	13 V	22 V	50 V	95 V
Switching time C / O	6 ms / 10 ms			
Operating frequency	30 Hz			
Permissible leakage current	1 mA		2 mA	

Output	
Output voltage	4.5 V to 58 V DC
Output current min.	0.5 mA
Output current max.	30 mA
Output leakage current at U_{max}	< 50 μ A
Residual voltage at I max and U rated	typical
	max
Frequency on inductive load	2500 V RMS
Isolation Input / Output	input / Output

Temperature	
Ambient temperature	storage
	operating

Other characteristics	
Body material	grey
Wire size	Solid wire
	Stranded wire
Rated wire size	
Wire stripping length	
Recommended screwdriver	
Protection	
Recommended torque	
Approvals	
Reference standards	

Derating curve

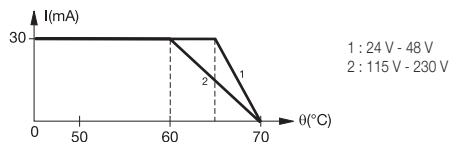

D 2,5/5-OBIA-0030

Dimensional drawings

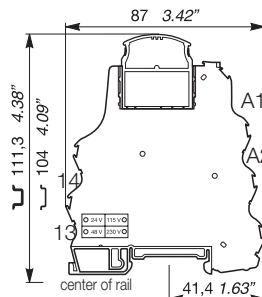



Optocouplers R500 range

Technical data

Technical data

Pluggable optocoupler : 5 to 58 V DC output / 100 mA - 5.08 mm 0.200" spacing

	D 2,5/5-OB0C-0100 5 V DC / 24 V DC		D 2,5/5-OB0C-0100 48 V DC
Input			
Input voltage	4.5 V to 5.5 V DC	20.4 V to 28.8 V DC	40.8 V to 57.6 V DC
Frequency			
Input current	8.5 mA	4.8 mA	3.9 mA
Pull-in voltage at Is=100%	2.9 V DC	16 V DC	26 V DC
Switching time C / O	20 µs / 1.3 ms		
Operating frequency	400 Hz		
Permissible leakage current	1 mA		
Output			
Output voltage	4.5 V to 58 V DC		
Output current min.	1 mA		
Output current max.	100 mA		
Output leakage current at U _{rmax}	< 50 µA		
Redidual voltage at I max and U rated	typical	1 V DC	
	max	1.3 V DC	
Frequency on inductive load	See Note 1		
Isolation Input / Output	input / Output	2500 V RMS	
Temperature			
Ambient temperature	storage	-40...+80 °C	
	operating	See derating curve	
Other characteristics			
Body material	grey	UL 94 V0	
Wire size	Solid wire	0.2 - 4 mm ² (24-12 AWG)	
	Stranded wire	0.22 - 2.5 mm ² (24-12 AWG)	
Rated wire size		2.5 mm ² (12 AWG)	
Wire stripping length		9 mm (0.354 in)	
Recommended screwdriver		3.5 mm (0.137 in)	
Protection		IP20 NEMA1	
Recommended torque		0.4-0.6 Nm (3.5-5.3 lb.in)	
Approvals		c  us (pending), 	
Reference standards		CEI 947-7-1 / CEI 947-1 / CEI 1131-2 (in relevant parts) / CEI 60664-1 / CEM : IEC 1000-4-2, 3, 4, 5, 6.	

Note 1 :

$$F_{max} = (1 - 0,007 \times U_s) / (L \times I_s^2)$$

or

$$F_{max} = (1 - 0,007 \times U_s) / (P \times \frac{L}{R})$$

- U_s = Output voltage
- I_s = Output current
- L = Inductance of load
- P = Power of load
- R = Resistance of load

Derating curve

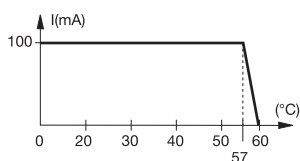

D 2,5/5-OB0C-0100 5 V DC / 24 V DC

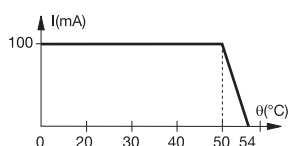

D 2,5/5-OB0C-0100 48 V DC

Dimensional drawings

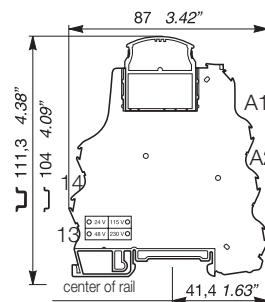

Optocouplers R500 range

Technical data

Technical data

Pluggable optocoupler : 5 to 58 V DC output / 1 A - 5.08 mm 0.200" spacing

	D 2,5/5-OBOC-1000 5/24 V DC		D 2,5/5-OBOC-1000 24/48 V AC/DC				D 2,5/5-OBOC-1000 110/230 V AC	
	5 V DC	24 V DC	24 V AC	24 V DC	48 V AC	48 V DC	110 V AC	230 V AC
Input								
Input voltage	4.5 - 5.5 V DC	20.4 - 28.8 V DC	24 ± 10 %	20.4 - 28.8 V DC	48 ± 10 %	40.8 to 57.6 V DC	110 ± 10 %	230 ± 10 %
Frequency			50 / 60 Hz		50 / 60 Hz		50 / 60 Hz	50 / 60 Hz
Input current	12.3 mA	6.7 mA	10.5 mA	8 mA	6.8 mA	5.8 mA	8.5 mA	7.5 mA
Pull-in voltage at Is=100%	3.5 V DC	10 V DC						
Switching time C / O	20 / 250 µs	50 / 350 µs	15 / 13 ms	5 / 13 ms	15 / 15 ms	6 / 25 ms	15 / 15 ms	15 / 15 ms
Operating frequency	2000 Hz	1500 Hz	20 Hz					
Permissible leakage current								
Output								
Output voltage	4.5 V to 58 V DC							
Output current min.	1 mA							
Output current max.	1 A							
Output leakage current at U _{max}	< 50 µA							
Residual voltage at I _{max} and U _{rated}	typical	0.1 V DC						
	max	0.5 V DC						
Frequency on inductive load	See Note 1							
Isolation Input / Output	input / Output	2500 V RMS						
Temperature								
Ambient temperature	storage	-40...+80 °C						
	operating	See derating curve						
Other characteristics								
Body material	grey	UL 94 V0						
Wire size	Solid wire	0.2 - 4 mm ² (24-12 AWG)						
	Stranded wire	0.22 - 2.5 mm ² (24-12 AWG)						
Rated wire size		2.5 mm ² (12 AWG)						
Wire stripping length		10 mm (0.394 in)						
Recommended screwdriver		3.5 mm (0.137 in)						
Protection		IP20 NEMA1						
Recommended torque		0.4-0.6 Nm (3.5-5.3 lb.in)						
Approvals		cULus (pending), CE						
Reference standards		CEI 947-7-1 / CEI 947-1 / CEI 1131-2 (in relevant parts) / CEI 60664-1 / CEM : IEC 1000-4-2, 3, 4, 5, 6.						

Note 1 :

$$I_{max} = (1 - 0,007 \times U_s) / (L \times I_s^2)$$

or

$$I_{max} = (1 - 0,007 \times U_s) / (P \times \frac{L}{R})$$

U_s = Output voltage
I_s = Output current
L = Inductance of load
P = Power of load
R = Resistance of load

Derating curve

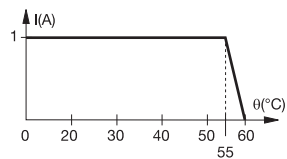

Dimensional drawings

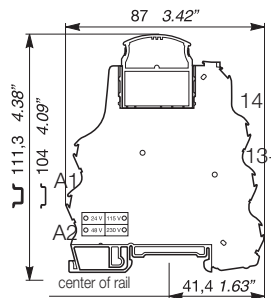



Optocouplers R500 range

Technical data

Technical data

Pluggable optocoupler : 5 to 30 V DC output / 2 A - 5.08 mm 0.200" spacing

	D 2,5/5-OB0C-2000 5/24 V DC		D 2,5/5-OB0C-2000 24/48 V AC/DC				D 2,5/5-OB0C-2000 110/230 V AC	
Input	5 V DC	24 V DC	24 V AC	24 V DC	48 V AC	48 V DC	110 V AC	230 V AC
Input voltage	4.5 - 5.5 V DC	20.4 - 28.8 V DC	24 ± 10 %	20.4 - 28.8 V DC	48 ± 10 %	40.8 to 57.6 V DC	110 ± 10 %	230 ± 10 %
Frequency			50 / 60 Hz		50 / 60 Hz		50 / 60 Hz	50 / 60 Hz
Input current	12.3 mA	6.7 mA	10.5 mA	8 mA	6.8 mA	5.8 mA	8.5 mA	7.5 mA
Pull-in voltage at Is=100%	3.5 V DC	10 V DC						
Switching time C / O	20 / 250 µs	50 / 350 µs	15 / 13 ms	5 / 13 ms	15 / 15 ms	6 / 25 ms	15 / 15 ms	15 / 15 ms
Operating frequency	2000 Hz	1500 Hz	20 Hz					
Permissible leakage current								
Output								
Output voltage	4.5 V to 30 V DC							
Output current min.	1 mA							
Output current max.	2 A							
Output leakage current at U _{max}	< 50 µA							
Residual voltage at I _{max} and U rated	typical 0.1 V DC							
	max 0.5 V DC							
Frequency on inductive load	See Note 1							
Isolation Input / Output	input / Output	2500 V RMS						
Temperature								
Ambient temperature	storage	-40...+80 °C						
	operating	See derating curve						
Other characteristics								
Body material	grey	UL 94 V0						
Wire size	Solid wire	0.2 - 4 mm ² (24-12 AWG)						
	Stranded wire	0.22 - 2.5 mm ² (24-12 AWG)						
Rated wire size	2.5 mm ² (12 AWG)							
Wire stripping length	10 mm (0.394 in)							
Recommended screwdriver	3.5 mm (0.137 in)							
Protection	IP20 NEMA1							
Recommended torque	0.4-0.6 Nm (3.5-5.3 lb.in)							
Approvals	c  us (pending), 							
Reference standards	CEI 947-7-1 / CEI 947-1 / CEI 1131-2 (in relevant parts) / CEI 60664-1 / CEM : IEC 1000-4-2, 3, 4, 5, 6.							

Note 1 :

$$F_{max} = (1 - 0,012 \times U_s) / (L \times I_s^2)$$

or

$$F_{max} = (1 - 0,012 \times U_s) / (P \times \frac{L}{R})$$

- U_s = Output voltage
- I_s = Output current
- L = Inductance of load
- P = Power of load
- R = Resistance of load

Derating curve

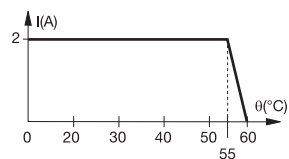

Dimensional drawings

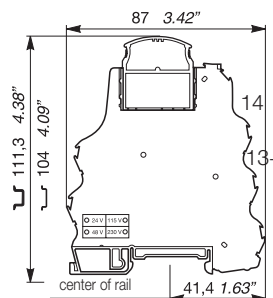

Optocouplers R500 range

Technical data

Technical data

Pluggable optocoupler : 24 to 253 V AC output / 1 A - 5.08 mm 0.200" spacing

	D 2,5/5-... 24 V DC	D 2,5/5-OBOA-1000 24 V AC/DC - 48 V AC/DC				D 2,5/5-OBOA-1000 110 V AC - 230 V AC	
Input	24 V DC	24 V AC	24 V DC	48 V AC	48 V DC	110 V AC	230 V AC
Input voltage	20.4 - 28.8 V DC	24 ± 10 %	20.6 - 28.8 V DC	48 ± 10 %	40.8 - 57.6 V DC	110 ± 10 %	230 ± 10 %
Frequency		50 / 60 Hz		50 / 60 Hz		50 / 60 Hz	50 / 60 Hz
Input current	4 mA	10 mA	7 mA	6 mA	5 mA	8 mA	7.5 mA
Pull-in voltage at Is=100%							
Switching time C / O	10/20 ms	20/20 ms	10/20 ms	20/20 ms	10/20 ms	20/20 ms	20/20 ms
Operating frequency	15 Hz						
Permissible leakage current							
Output	24-253 V AC - 50/60 Hz						
Output voltage	24-253 V AC - 50/60 Hz						
Output current min.	25 mA						
Output current max.	1 A						
Output leakage current at U _{max}	< 0.50 mA						
Residual voltage at I max and U rated	typical	1 V					
	max	1.6 V					
Frequency on inductive load	See Note 1						
Isolation Input / Output	input / Output	2500 V RMS					
Temperature							
Ambient temperature	storage	-40...+80 °C					
	operating	See derating curve					
Other characteristics							
Body material	grey	UL 94 V0					
Wire size	Solid wire	0.2 - 4 mm ² (24-12 AWG)					
	Stranded wire	0.22 - 2.5 mm ² (24-12 AWG)					
Rated wire size	2.5 mm ² (12 AWG)						
Wire stripping length	10 mm (0.394 in)						
Recommended screwdriver	3.5 mm (0.137 in)						
Protection	IP20 NEMA1						
Recommended torque	0.4-0.6 Nm (3.5-5.3 lb.in)						
Approvals	cULus (pending), CE						
Reference standards	CEI 947-7-1 / CEI 947-1 / CEI 1131-2 (in relevant parts) / CEI 60664-1 / CEM : IEC 1000-4-2, 3, 4, 5, 6.						

Note 1 :

$$F_{max} = (1 - 0,012 \times U_s) / (L \times I_s^2)$$

or

$$F_{max} = (1 - 0,012 \times U_s) / (P \times \frac{L}{R})$$

U_s = Output voltage
I_s = Output current
L = Inductance of load
P = Power of load
R = Resistance of load

Derating curve

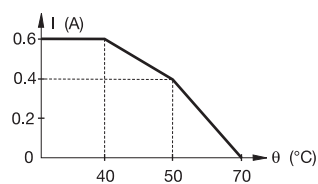

Dimensional drawings

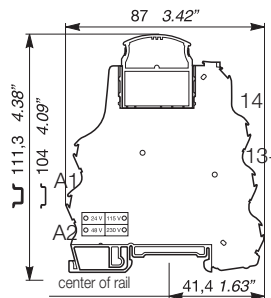

Interface relays and optocouplers R600 range
Product group picture

5

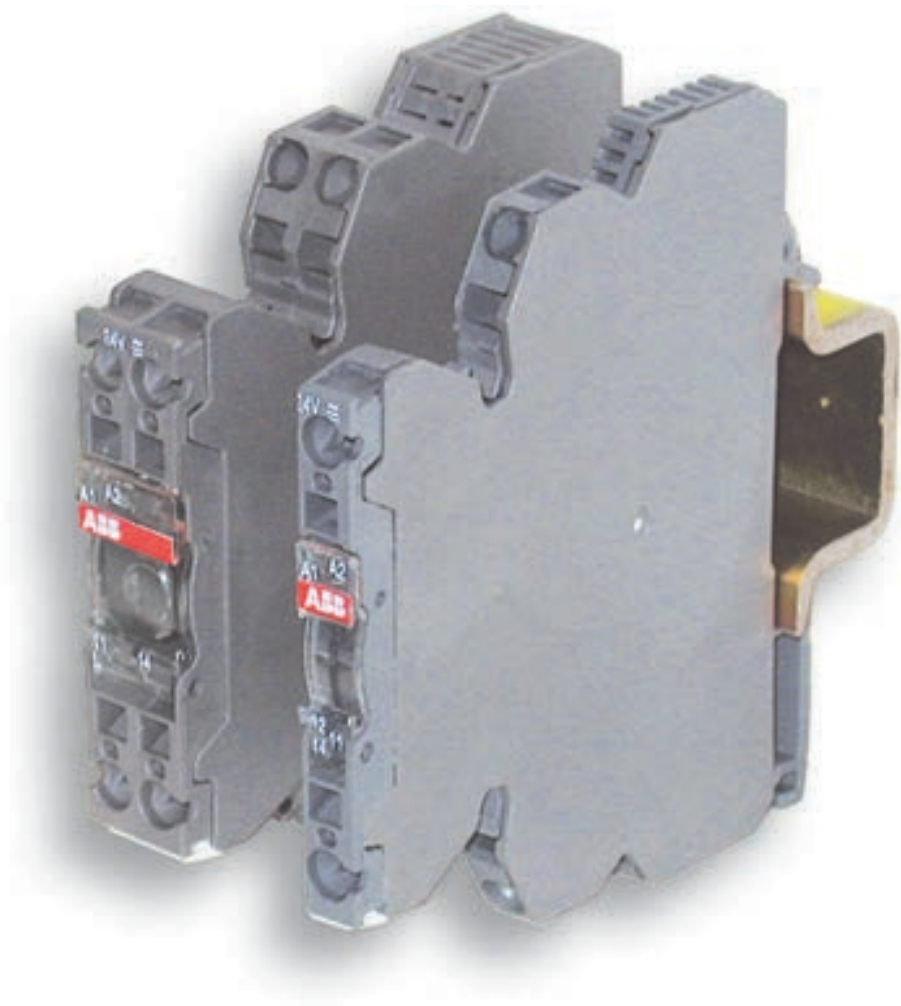

Interface relays and optocouplers R600 range

Table of contents

Interface relays and optocouplers R600 range	
Product group picture	5/45
Table of contents	5/46
Interface relays R600 range	5/47
Product group picture	5/47
Table of contents	5/48
Benefits and advantages	5/49
Selection	5/51
Ordering details	5/53
Connection diagrams	5/55
Technical data	5/56
General technical data	5/61
Dimensional drawings, Load limit curves	5/62
Optocouplers R600 range	5/63
Product group picture	5/63
Table of contents	5/64
Selection	5/65
Ordering details	5/67
Connection diagrams	5/68
Technical data	5/69

Interface relays R600 range
Product group picture

5

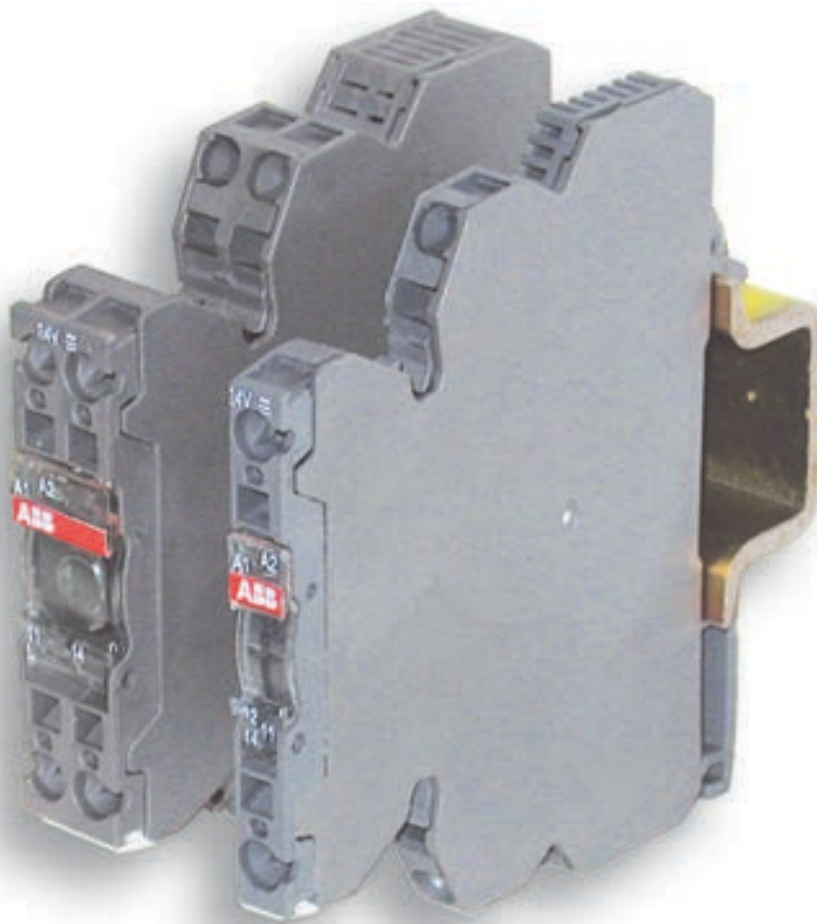

Interface relays R600 range

Table of contents

Interface relays R600 range	
Product group picture	5/47
Table of contents	5/48
Benefits and advantages	5/49
Selection	5/51
Ordering details	5/53
Connection diagrams	5/55
Technical data	5/56
General technical data	5/61
Dimensional drawings, Load limit curves	5/62

Interface relays R600 range

Benefits and advantages

Characteristics

- Standard range available with screw or spring-type terminals
- 8 different rated control supply voltages:
 - DC versions: 5 V, 12 V, 24 V
 - AC/DC versions: 24 V, 48-60 V, 115 V, 230 V, 60-230 V
- Output: 1 n/c contact, 1 n/o contact, 1 c/o (SPDT) contact, 2 c/o (SPDT) contacts
- Devices with output contacts protected by built in RC circuit, which result in increased contact life
- Devices with leakage current protection on the input side
- Available with visible or covered switch on the front of the unit, for the configuration of manual or automatic actuation
- With connection for jumper bar, except 2 c/o devices and some discontinued devices
- Width: 6 mm (0.236 in) or 12 mm (0.472 in)
- LED for the indication of the operational state
- Accessories: Jumper bars, separator end section and distribution blocks

5

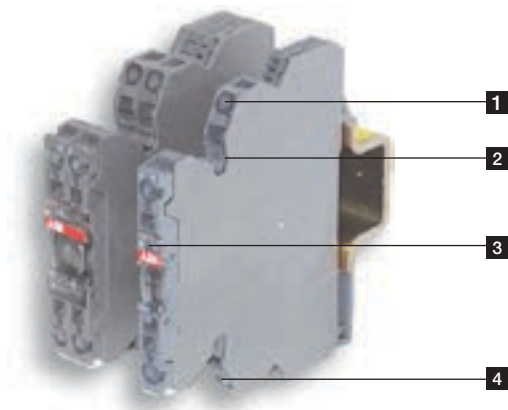

- 1** Input - Control supply voltage
- 2** Jumper bar connection
- 3** Indication of operational states (green LED)
- 4** Output

Excellent adaption and conversion of digital signals

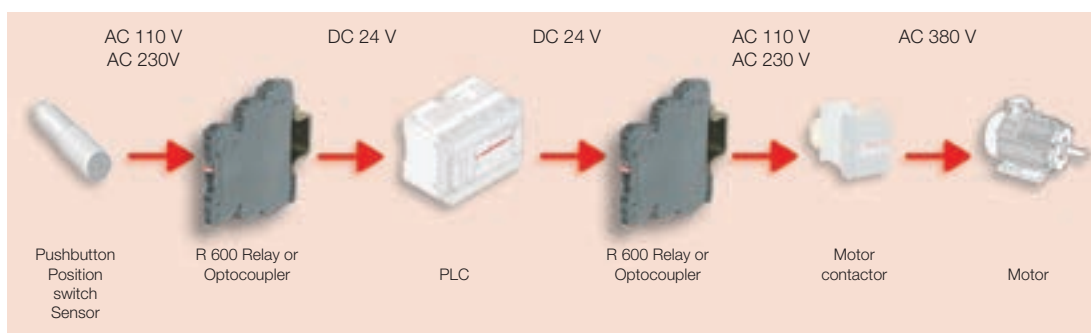

Interface relays R600 range

Benefits and advantages

Interface relays are electromechanic and electronic input and output modules for electrical isolation, levelling, noise suppression or signal amplification between control unit and process.

Boxed interface relays are used for electrical isolation, amplification and signal matching between the electronic controlling, e.g. PLC (programmable logic controller), PC or field bus systems and the sensor / actuator level. The compact design and different connection terminal possibilities optimize your panel installation.

Increased contact life

The contacts of some devices are protected by built in RC-circuits which result in increased contact life.

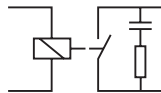

Variety of connections

R600 relays and optocouplers are available with both screw terminals or spring terminals.

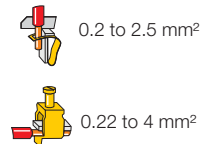

Space saving

With a width of only 6 mm or 12 mm the compact design saves space in each cabinet.

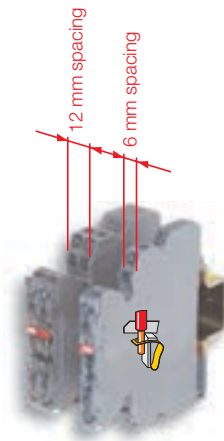

Functioning status

Functioning display through a green LED.



Only one part number AC/DC

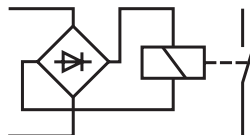

Measurement & Test

Holes for holding DIA. 2 mm test plugs to simplify any measury or test.



Approvals

 UL 508
CAN/CSA C22.2 No.14

 Lloyds Register

pending

Marks

 CE

Interface relays R600 range

Selection

Type	Order number
RB 121-5VDC	1SNA 645 034 R2300
RB 121-5VDC	1SNA 645 036 R2500
RBR 121-5VDC	1SNA 645 534 R2500
RBR 121-5VDC	1SNA 645 536 R2700
RB 121-12VDC	1SNA 645 069 R0000
RB 121-12VDC	1SNA 645 037 R2600
RBR 121-12VDC	1SNA 645 537 R2000
RB 101AR-24VAC/DC	1SNA 645 019 R0400
RBR 101AR-24VAC/DC	1SNA 645 519 R0600
RB 111A-24VAC/DC	1SNA 645 014 R2700
RB 111AI-24VAC/DC	1SNA 645 063 R0000
RB 111AR-24VAC/DC	1SNA 645 018 R0300
RBR 111A-24VAC/DC	1SNA 645 514 R2100
RBR 111AI-24VAC/DC	1SNA 645 563 R0200
RBR 111AR-24VAC/DC	1SNA 645 518 R0500
RB 121-24VDC	1SNA 645 064 R0100
RB 121-24VDC	1SNA 645 065 R0200
RB 121A-24VAC/DC	1SNA 645 001 R0300
RB 121A-24VAC/DC	1SNA 645 005 R0700
RB 121AI-24VAC/DC	1SNA 645 032 R2100
RB 121AI-24VAC/DC	1SNA 645 009 R1300
RB 121AI-24VAC/DC	1SNA 645 033 R2200
RB 121AI-24VAC/DC	1SNA 645 010 R0700
RBR 121-24VDC	1SNA 645 564 R0300
RBR 121-24VDC	1SNA 645 565 R0400
RBR 121A-24VAC/DC	1SNA 645 501 R0500
RBR 121A-24VAC/DC	1SNA 645 505 R0100
RBR 121AI-24VAC/DC	1SNA 645 532 R2300
RBR 121AI-24VAC/DC	1SNA 645 509 R1500
RBR 121AI-24VAC/DC	1SNA 645 533 R2400
RBR 121AI-24VAC/DC	1SNA 645 510 R0100
RB 122A-24VAC/DC	1SNA 645 012 R2500
RBR 122A-24VAC/DC	1SNA 645 512 R2700

Input voltage																									
5 V DC	■	■	■	■																					
12 V DC					■	■	■																		
24 V DC								■	■	■	■	■	■	■	■	■	■	■	■	■	■	■	■	■	■
48 - 60 V DC																									
115 V DC																									
230 V DC																									
60 - 230 V DC																									
24 V AC								■	■	■	■	■	■	■	■	■	■	■	■	■	■	■	■	■	■
48 - 60 V AC																									
115 V AC																									
230 V AC																									
60 - 230 V AC																									

Output rating																									
10 mA - 6 A	■	■	■	■	■	■	■	■	■	■	■	■	■	■	■	■	■	■	■	■	■	■	■	■	■
1 mA - 6 A		■	■	■	■	■																			
1 mA - 8 A																								■	■

Output contacts																									
c/o	1	1	1	1	1	1	1																		
n/o																									
n/c								1	1																

Terminal type																									
Screw	■	■			■	■			■	■	■	■	■	■	■	■	■	■	■	■	■	■	■	■	■
Spring			■	■			■																		

Interface relays R600 range

Selection

RB 111A-48-60VAC/DC	1SNA 645 015 R2000
RBR 111A-48-60VAC/DC	1SNA 645 515 R2200
RB 121A-48-60VAC/DC	1SNA 645 002 R0400
RB 121A-48-60VAC/DC	1SNA 645 006 R0000
RBR 121A-48-60VAC/DC	1SNA 645 502 R0600
RBR 121A-48-60VAC/DC	1SNA 645 506 R0200
RB 122A-48-60VAC/DC	1SNA 645 040 R1500
RBR 122A-48-60VAC/DC	1SNA 645 540 R1700
RB 121A-115VAC/DC	1SNA 645 003 R0500
RB 121A-115VAC/DC	1SNA 645 007 R0100
RB 121AR-115VAC/DC	1SNA 645 046 R0700
RBR 121A-115VAC/DC	1SNA 645 503 R0700
RBR 121A-115VAC/DC	1SNA 645 507 R0300
RBR 121AR-115VAC/DC	1SNA 645 546 R0100
RB 122A-115VAC/DC	1SNA 645 041 R0200
RBR 122A-115VAC/DC	1SNA 645 541 R0400
RB 111A-115VAC/DC	1SNA 645 016 R2100
RBR 111A-115VAC/DC	1SNA 645 516 R2300
RB 111A-230VAC/DC	1SNA 645 017 R2200
RBR 111A-230VAC/DC	1SNA 645 517 R2400
RB 121A-230VAC/DC	1SNA 645 004 R0400
RB 121A-230VAC/DC	1SNA 645 008 R1200
RB 121AR-230VAC/DC	1SNA 645 011 R2400
RBR 121A-230VAC/DC	1SNA 645 504 R0000
RBR 121A-230VAC/DC	1SNA 645 508 R1400
RBR 121AR-230VAC/DC	1SNA 645 511 R2600
RB 122A-230VAC/DC	1SNA 645 013 R2600
RBR 122A-230VAC/DC	1SNA 645 513 R2000
RB 121A 60-230VUC	1SNA 645 020 R0100
RBR 121A 60-230VUC	1SNA 645 520 R0300

Interface relays R600 range

Ordering details



2CDC 291 024 50013

5

R600

R600 Relay	Type	Order code	Price	Pkg qty	Weight (1 pce) kg (lb)
Relay module 1 NO high level 6 mm spacing	RB 111 A-24VAC/DC	1SNA645014R2700		10	0.02 (0.44)
	RB 111 A-48-60VAC/DC	1SNA645015R2000			
	RB 111 A-115VAC/DC	1SNA645016R2100			
	RB 111 A-230VAC/DC	1SNA645017R2200			
Relay mod. 1 NO high level w/safety switch 6 mm spacing	RB 111 AI-24VAC/DC	1SNA645063R0000			
Relay mod. 1 NO high level w/contact protection 12 mm spacing	RB 111 AR-24VAC/DC	1SNA645018R0300		5	0.03 (0.44)
Relay mod. 1 NC high level w/contact protection 12 mm spacing	RB 101 AR-24VAC/DC	1SNA645019R0400			
Relay module 1 NO high level 6 mm spacing	RBR 111 A-24VAC/DC	1SNA645514R2100		10	0.02 (0.44)
	RBR 111 A-48-60VAC/DC	1SNA645515R2200			
	RBR 111 A-115VAC/DC	1SNA645516R2300			
Relay mod. 1 NO high level w/safety switch 6 mm spacing	RBR 111 AI-24VAC/DC	1SNA645563R0200			
Relay mod. 1 NO high level w/contact protection 12 mm spacing	RBR 111 AR-24VAC/DC	1SNA645518R0500		5	0.03 (0.44)
Relay mod. 1 NC high level w/contact protection 12 mm spacing	RBR 101 AR-24VAC/DC	1SNA645519R0600			
Relay module 1 SPDT high level	RB 121-5VDC	1SNA645034R2300		10	0.02 (0.44)
	RB 121-12VDC	1SNA645069R0100			
	RB 121-24VDC	1SNA645064R0100			
	RB 121 A-24VAC/DC	1SNA645001R0300			
	RB 121 A-48-60VAC/DC	1SNA645002R0400			
	RB 121 A-115VAC/DC	1SNA645003R0500			
Relay module 1 SPDT high level	RB 121 A-230VAC/DC	1SNA645004R0400		10	0.02 (0.44)
	RB 121-5VDC	1SNA645534R2500			
	RB 121-12VDC	1SNA645569R0000			
	RB 121-24VDC	1SNA645564R0300			
	RB 121 A-24VAC/DC	1SNA645501R0500			
	RB 121 A-48-60VAC/DC	1SNA645502R0600			
Relay module 1 SPDT low level	RB 121 A-115VAC/DC	1SNA645503R0700		10	0.02 (0.44)
	RB 121 A-230VAC/DC	1SNA645504R0000			
	RB 121-5VDC	1SNA645036R2500			
	RB 121-12VDC	1SNA645037R2600			
	RB 121-24VDC	1SNA645065R0200			
	RB 121 A-24VAC/DC	1SNA645005R0700			
Relay module 1 SPDT low level	RB 121 A-48-60VAC/DC	1SNA645006R0000		10	0.02 (0.44)
	RB 121 A-115VAC/DC	1SNA645007R0100			
	RB 121 A-230VAC/DC	1SNA645008R1200			
	RB 121-5VDC	1SNA645536R2700			
	RB 121-12VDC	1SNA645537R2000			
	RB 121-24VDC	1SNA645565R0400			
Relay module 1 SPDT low level	RB 121 A-24VAC/DC	1SNA645505R0100		10	0.02 (0.44)
	RB 121 A-48-60VAC/DC	1SNA645506R0200			
	RB 121 A-115VAC/DC	1SNA645507R0300			
	RB 121 A-230VAC/DC	1SNA645508R1400			

Interface relays R600 range

Ordering details



R600

R600 Relay	Type	Order code	Price	Pkg qty	Weight (1 pce) kg (lb)
Relay mod. 1SPDT high level w/ leakage current protec.	RB 121 AR-115VAC/DC	1SNA645046R0700		5	0.03 (0.066)
	RB 121 AR-230VAC/DC	1SNA645011R2400			
Relay mod. 1SPDT high level w/ large coil voltage range	RB 121 A 60-230VAC/DC	1SNA645020R0100			
Relay mod. 1SPDT high level with switch	RB 121 AI-24VAC/DC	1SNA645032R2100			
Relay mod. 1SPDT high level with safety switch	RB 121 AI-24VAC/DC	1SNA645009R1300			
Relay module 1SPDT low level with switch	RB 121 AI-24VAC/DC	1SNA645033R2200			
Relay module 1SPDT low level with safety switch	RB 121 AI-24VAC/DC	1SNA645010R0700			
Relay mod. 1SPDT high level w/ leakage current protec.	RB 121 AR-115VAC/DC	1SNA645546R0100			
	RB 121 AR-230VAC/DC	1SNA645511R2600			
Relay mod. 1SPDT high level w/ large coil voltage range	RB 121 A 60-230VAC/DC	1SNA645520R0300			
Relay mod. 1SPDT high level with switch	RB 121 AI-24VAC/DC	1SNA645532R2300			
Relay mod. 1SPDT high level with safety switch	RB 121 AI-24VAC/DC	1SNA645509R1500			
Relay module 1SPDT low level with switch	RB 121 AI-24VAC/DC	1SNA645533R2400			
Relay module 1SPDT low level with safety switch	RB 121 AI-24VAC/DC	1SNA645510R0100			
Relay module 1 DPDT low level	RB 122 A-24VAC/DC	1SNA645012R2500			
	RB 122 A-48-60VAC/DC	1SNA645040R1500			
	RB 122 A-115VAC/DC	1SNA645041R0200			
	RB 122 A-230VAC/DC	1SNA645013R2600			
Relay module 1 DPDT low level	RBR 122 A-24VAC/DC	1SNA645512R2700			
	RBR 122 A-48-60VAC/DC	1SNA645540R1700			
	RBR 122 A-115VAC/DC	1SNA645541R0400			
	RBR 122 A-230VAC/DC	1SNA645513R2000			

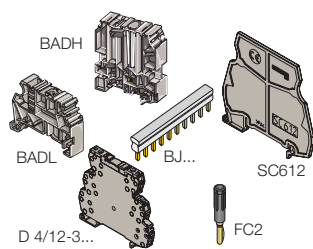

Accessories R600	Type	Order code	Price	Pkg qty	Weight (1 pce) kg (lb)
End section	BADH V0	1SNA116900R2700		50	
	BADL V0	1SNA399903R0200		50	
	BAM2 V0	1SNA399967R0100		50	
Seperator end section	SC 612	1SNA290474R0200		10	
Divisible shunt 10 poles	BJ 612-10	1SNA290488R0100		10	
Divisible shunt 20 poles	BJ 612-20	1SNA206754R0000		10	
Screw clamp distribution block sp. 12 mm	D4/12-3-3	1SNA645031R2000		5	
Spring clamp distribution block sp. 12 mm	D4/12-3R-3R	1SNA645531R2200		5	
Test plug DIA. 2 mm	FC2	1SNA645531R2200		10	
Marking method	RC65 / RC610	see marking			

Interface relays R600 range

Connection diagrams

11-12 n/c contact
 13-14 n/o contact
 11-12/14 1st c/o contact
 21-22/24 2nd c/o contact

A1-A2 Control supply voltage
 S1 Connection for jumper bar (input side)
 S2 Connection for jumper bar (output side)

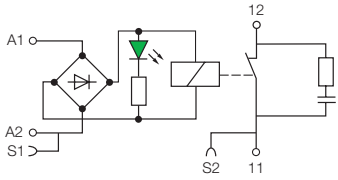

2CDC 292 030 F0013

RB/RBR 101 AR

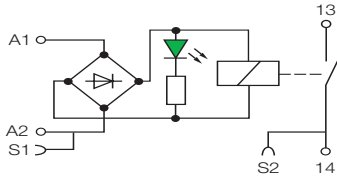

2CDC 292 031 F0013

RB/RBR 111 A - 24 V AC/DC

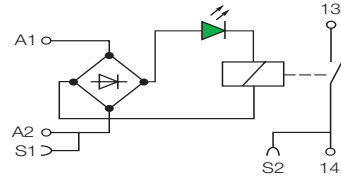

2CDC 292 033 F0013

RB/RBR 111 A - 48/60/115/230 V AC/DC

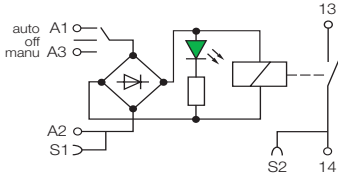

2CDC 292 034 F0013

RB/RBR 111 AI

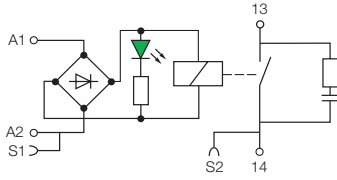

2CDC 292 035 F0013

RB/RBR 111 AR

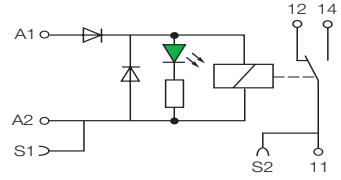

2CDC 292 036 F0013

RB/RBR 121
 - 5 V DC, A1-A2 polarized
 - 12 V DC, A1-A2 polarized, i.e. only:
 1SNA645035R2400, 1SNA645535R2600
 1SNA645037R2600, 1SNA645537R2000

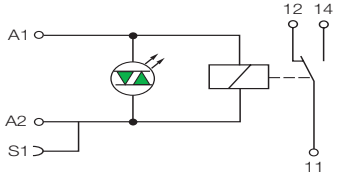

2CDC 292 037 F0013

RB/RBR 121
 - 12/24 V DC, only discontinued versions:
 1SNA645069R0000
 1SNA645064R0100, 1SNA645564R0300
 1SNA645065R0200, 1SNA645565R0400

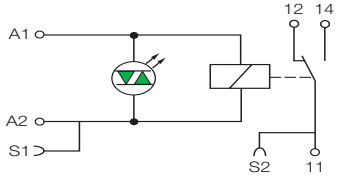

2CDC 292 038 F0013

RB/RBR 121 (AU)
 - 12/24 V DC, except:
 1SNA645035R2400, 1SNA645535R2600
 1SNA645037R2600, 1SNA645537R2000
 see connection diagram RB...121-5VDC

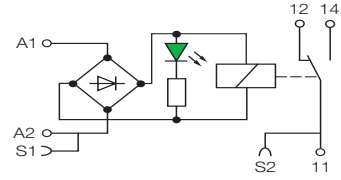

2CDC 292 039 F0013

RB/RBR 121 A
 - 24 V AC/DC

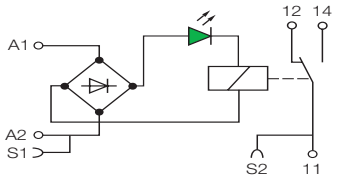

2CDC 292 040 F0013

RB/RBR 121 A - 48/60/115/230 V AC/DC

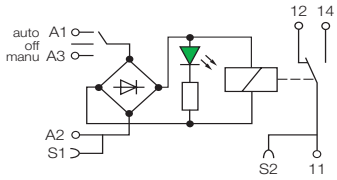

2CDC 292 041 F0013

RB/RBR 121 AI

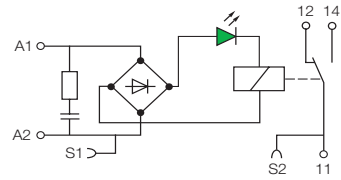

2CDC 292 042 F0013

RB/RBR 121 AR

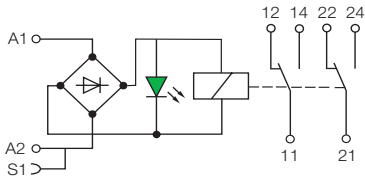

2CDC 292 043 F0013

RB/RB 122 A - 24/48/60 V AC/DC

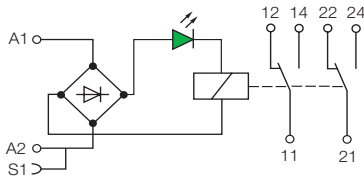

2CDC 292 044 F0013

RB/RBR 122 A - 115/230 V AC/DC

Interface relays R600 range

Technical data

Technical data

		RB 111 A				RB 111 AI	
Input circuit							
Rated control supply voltage U _s		24 V AC/DC	48 V AC/DC	60 V AC/DC	115 V AC/DC	230 V AC/DC	24 V AC/DC
Rated control supply voltage U _s tolerance	DC	-15 %, +20 %				-15 %, +10 %	-15 %, +20 %
	AC	-/+ 10 %					
Rated frequency		50/60 Hz					
Typical power consumption		0.24 W	0.34 W	0.54 W	0.46 W	0.8 W	0.24 W
Typical current		10 mA	7 mA	9 mA	4 mA	3.5 mA	10 mA
Drop-out voltage		4.5 V	8 V	8 V	17 V	27 V	4.5 V
Indication of operational states	green LED	┌ ───┐ : control supply voltage applied					
Output circuit							
Kind of output	13-14	relay, 1 n/o contact					
Rated operational voltage U _a (IEC/EN 60947-1)		250 V AC					
Minimum switching voltage		12 V					
Maximum switching voltage		250 V AC					
Minimum switching current		10 mA					
Rated operational current (IEC/EN 60947-5-1)	AC12 (resistive) 230 V	6 A					
	AC15 (inductive) 230 V	1.5 A					
	AC15 (inductive) 120 V	3 A					
	DC12 (resistive) 24 V	6 A					
	DC13 (inductive) 24 V	1 A					
	DC13 (inductive) 120 V	0.2 A					
	DC13 (inductive) 230 V	0.1 A					
AC rating (UL 508; NEMA ICS-5)	Utilization category (pilot duty)	B300					
DC rating (UL 508; NEMA ICS-5)	Utilization category (pilot duty)	R300					
Minimum switching power		0.6 W / 0.6 VA					
Mechanical lifetime		1 x 10 ⁷ switching cycles					
Electrical lifetime	at AC15	1 x 10 ⁵ switching cycles					
Response time		5 ms	5 ms	5 ms	6 ms	7 ms	5 ms
Release time		8 ms	8 ms	8 ms	15 ms	15 ms	8 ms
Dimensions and weight		RB 111 A / RB 111 AI high level			RBR 111 A / RBR 111 AI high level		
Weight	net weight	0.02 kg (0.044 lb)					
Dimension	product dimension	6 x 75 x 75 mm (0.236 x 2.95 x 2.95 in)					
	packaging dimension						

Interface relays R600 range

Technical data

Technical data

		RB... 111AR high level	RB... 101AR high level
Input circuit			
Rated control supply voltage U _s		24 V AC/DC	
Rated control supply voltage U _s tolerance	DC	-15 %, +20 %	
	AC	-/+ 10 %	
Rated frequency		50/60 Hz	
Typical power consumption		0.24 W	
Typical current		10 mA	
Drop-out voltage		4.5 V	
Indication of operational states	green LED	┌───┐: control supply voltage applied	
Output circuit			
Kind of output	11-12	-	relay, 1 n/c contact
	13-14	relay, 1 n/o contact	-
Rated operational voltage U _B (IEC/EN 60947-1)		250 V AC	
Minimum switching voltage		12 V	
Maximum switching voltage		250 V AC	
Minimum switching current		10 mA	
Rated operational current (IEC/EN 60947-5-1)	AC12 (resistive) 230 V	6 A	
	AC15 (inductive) 230 V	1.5 A	
	AC15 (inductive) 120 V	3 A	
	DC12 (resistive) 24 V	6 A	
	DC13 (inductive) 24 V	1 A	
	DC13 (inductive) 120 V	0.2 A	
	DC13 (inductive) 230 V	0.1 A	
AC rating (UL 508; NEMA ICS-5)	Utilization category (pilot duty)	B300	
DC rating (UL 508; NEMA ICS-5)	Utilization category (pilot duty)	R300	
Minimum switching power		0.6 W / 0.6 VA	
Mechanical lifetime		1 x 10 ⁷ switching cycles	
Electrical lifetime	at AC15	1 x 10 ⁸ switching cycles	
Response time		5 ms	
Release time		8 ms	
Dimensions and weight			
Weight	net weight	RB 111AR / RB 101AR high level	RBR 111A / RBR 111AR high level
Dimension	product dimension	12 x 70 x 75 mm (0.472 x 2.76 x 2.95 in)	
	packaging dimension	12 x 75 x 75 mm (0.472 x 2.95 x 2.95 in)	

5

Interface relays R600 range

Technical data

Technical data

		RB... 121 / RB... 121A high level							
Input circuit									
Rated control supply voltage U _s		5 V DC	12 V DC	24 V AC/DC	48 V AC/DC	60 V AC/DC	115 V AC/DC	230 V AC/DC	
Rated control supply voltage U _s tolerance	DC	-15 %, +20 %						-15 %, +10 %	
	AC				-/+ 10 %				
Rated frequency					50/60 Hz				
Typical power consumption		0.2 W	0.2 W	0.24 W	0.33 W	0.54 W	0.46 W	0.8 W	
Typical current		40 mA	16 mA	10 mA	7 mA	9 mA	4 mA	3.5 mA	
Drop-out voltage		1.2 V	2.2 V	4.5 V	8 V	8 V	17 V	27 V	
Indication of operational states	green LED	 : control supply voltage applied							
Output circuit									
Kind of output	11-12/14	relay, 1 c/o (SPDT) contact							
Rated operational voltage U _a (IEC/EN 60947-1)		250 V AC							
Minimum switching voltage		12 V							
Maximum switching voltage		250 V AC							
Minimum switching current		10 mA							
Rated operational current (IEC/EN 60947-5-1)	AC12 (resistive) 230 V	6 A							
	AC15 (inductive) 230 V	1.5 A							
	AC15 (inductive) 120 V	3 A							
	DC12 (resistive) 24 V	6 A							
	DC13 (inductive) 24 V	1 A							
	DC13 (inductive) 120 V	0.2 A							
	DC13 (inductive) 230 V	0.1 A							
AC rating (UL 508; NEMA ICS-5)	Utilization category (pilot duty)	B300							
DC rating (UL 508; NEMA ICS-5)	Utilization category (pilot duty)	R300							
Minimum switching power		0.6 W / 0.6 VA							
Mechanical lifetime		1 x 10 ⁷ switching cycles							
Electrical lifetime	at AC15	1 x 10 ⁵ switching cycles							
Response time		5 ms	5 ms	5 ms	5 ms	5 ms	6 ms	7 ms	
Release time		8 ms						15 ms	16 ms
Dimensions and weight		RB 121 / RB 121A high level			RBR 122 / RBR 122A high level				
Weight	net weight	0.02 kg (0.044 lb)							
Dimension	product dimension	6 x 70 x 75 mm (0.236 x 2.76 x 2.95 in)			6 x 75 x 75 mm (0.236 x 2.95 x 2.95 in)				
	packaging dimension								

Interface relays R600 range

Technical data

Technical data

		RB... 121 / RB... 121A low level						
Input circuit								
Rated control supply voltage U _s		5 V DC	12 V DC	24 V AC/DC	48 V AC/DC	60 V AC/DC	115 V AC/DC	230 V AC/DC
Rated control supply voltage U _s tolerance	DC	-15 %, +20 %						-15 %, +10 %
	AC	-						-/+ 10 %
Rated frequency		50/60 Hz						
Typical power consumption		0.2 W	0.2 W	0.24 W	0.33 W	0.54 W	0.46 W	0.8 W
Typical current		40 mA	16 mA	10 mA	7 mA	9 mA	4 mA	3.5 mA
Drop-out voltage		1.2 V	2.2 V	4.5 V	8 V	8 V	17 V	27 V
Indication of operational states	green LED	┌ ───┐: control supply voltage applied						
Output circuit								
Kind of output	11-12/14	relay, 1 c/o (SPDT) contact						
Rated operational voltage U _e (IEC/EN 60947-1)		250 V AC						
Minimum switching voltage		5 V						
Maximum switching voltage		250 V AC						
Minimum switching current		1 mA						
Rated operational current (IEC/EN 60947-5-1)	AC12 (resistive) 230 V	6 A						
	AC15 (inductive) 230 V	1.5 A						
	AC15 (inductive) 120 V	3 A						
	DC12 (resistive) 24 V	6 A						
	DC13 (inductive) 24 V	1 A						
	DC13 (inductive) 120 V	0.2 A						
	DC13 (inductive) 230 V	0.1 A						
AC rating (UL 508; NEMA ICS-5)	Utilization category (pilot duty)	B300						
DC rating (UL 508; NEMA ICS-5)	Utilization category (pilot duty)	R300						
Minimum switching power		0.05 W / 0.05 VA						
Mechanical lifetime		1 x 10 ⁷ switching cycles						
Electrical lifetime	at AC15	1 x 10 ⁹ switching cycles						
Response time		5 ms	5 ms	5 ms	5 ms	5 ms	6 ms	7 ms
Release time		8 ms					15 ms	16 ms
Dimensions and weight		RB 121 / RB 121A low level			RBR 122 / RBR 122A low level			
Weight	net weight	0.02 kg (0.044 lb)						
Dimension	product dimension	6 x 70 x 75 mm (0.236 x 2.76 x 2.95 in)			6 x 75 x 75 mm (0.236 x 2.95 x 2.95 in)			
	packaging dimension							

5

Interface relays R600 range

Technical data

Technical data

		RB... 121AR / RB... 121AI low level			RB... 121AI low level
Input circuit					
Rated control supply voltage U _s		115 V AC/DC	230 V AC/DC	24 V AC/DC	24 V AC/DC
Rated control supply voltage U _s tolerance	DC	-20%, +15%	-10%, +15%	-20%, +15%	
	AC	-/+ 10 %			
Rated frequency		50/60 Hz			
Typical power consumption		2 W	2.8 W	0.24 W	0.24 W
Typical current		18 mA	12 mA	10 mA	10 mA
Drop-out voltage		17 V	27 V	4.5 V	
Indication of operational states	green LED	 : control supply voltage applied			
Output circuit					
Kind of output	11-12/14	relay, 1 c/o (SPDT) contact			
Rated operational voltage U _a (IEC/EN 60947-1)		250 V AC			
Minimum switching voltage		12 V			
				5 V	
Maximum switching voltage		250 V AC			
Minimum switching current		10 mA			
				1 mA	
Rated operational current (IEC/EN 60947-5-1)	AC12 (resistive) 230 V	6 A			
	AC15 (inductive) 230 V	1.5 A			
	AC15 (inductive) 120 V	3 A			
	DC12 (resistive) 24 V	6 A			
	DC13 (inductive) 24 V	1 A			
	DC13 (inductive) 120 V	0.2 A			
	DC13 (inductive) 230 V	0.1 A			
AC rating (UL 508; NEMA ICS-5)	Utilization category (pilot duty)	B300			
DC rating (UL 508; NEMA ICS-5)	Utilization category (pilot duty)	R300			
Minimum switching power		0.6 W / 0.6 VA			0.05 W / 0.05 VA
Mechanical lifetime		1 x 10 ⁷ switching cycles			
Electrical lifetime	at AC15	1 x 10 ⁵ switching cycles			
Response time		6 ms	7 ms	5 ms	5 ms
Release time		15 ms	16 ms	8 ms	8 ms
Dimensions and weight		RB 121AR/RB 121AI low/high level		RB 121AR/RBR 121AI low/high level	
Weight	net weight	0.03 kg (0.066 lb)			
Dimension	product dimension	12 x 70 x 75 mm (0.472 x 2.76 x 2.95 in)		12 x 75 x 75 mm (0.472 x 2.95 x 2.95 in)	
	packaging dimension				

5

Technical data

		RB... 122A low level				
Input circuit						
Rated control supply voltage U _s		24 V AC/DC	48 V AC/DC	60 V AC/DC	115 V AC/DC	230 V AC/DC
Rated control supply voltage U _s tolerance	DC	-15 %, +20 %				-15 %, +10 %
	AC	-/+ 10 %				
Rated frequency		50/60 Hz				
Typical power consumption		0.48 W	0.62 W	0.96 W	0.58 W	1.15 W
Typical current		20 mA	13 mA	16 mA	5 mA	5 mA
Drop-out		5.4 V	8.8 V	8.8 V V	20 V	10 V
Indication of operational states	green LED	 : control supply voltage applied				
Output circuit						
Kind of output	11-12/14	relay, 1st c/o (SPDT) contact				
	21-22/24	relay, 2nd c/o (SPDT) contact				
Rated operational voltage U _a (IEC/EN 60947-1)		250 V AC				
Minimum switching voltage		5 V				
Maximum switching voltage		250 V DC - 250 V AC				
Minimum switching current		1 mA				
Rated operational current (IEC/EN 60947-5-1)	AC12 (resistive) 230 V	8 A		5 A		
Minimum switching power		5 mW / 5 mA				
Mechanical lifetime		2 x 10 ⁷ switching cycles				
Electrical lifetime	at AC15	1 x 10 ⁵ switching cycles				
Response time		6 ms	10 ms	10 ms	6 ms	6 ms
Release time		10 ms	14 ms	14 ms	15 ms	15 ms
Dimensions and weight		RB 122A low level			RBR 122A low level	
Weight	net weight	0.03 kg (0.066 lb)				
Dimension	product dimension	12 x 70 x 75 mm (0.472 x 2.76 x 2.95 in)			12 x 75 x 75 mm (0.472 x 2.95 x 2.95 in)	
	packaging dimension					

Interface relays R600 range

General technical data

Technical data

		RB	RBR
General data			
Material of housing		UL 94 V0	
Degree of protection	housing / terminals	IP20 NEMA1	
Electrical connection		Screw terminal	Spring-type terminal
Wire size	fine-stranded	0.22-2.5 mm ² (24-14 AWG)	
	rigid	0.2-4 mm ² (24-12 AWG)	0.2-2.5 mm ² (24-14 AWG)
Stripping length		9 mm / 0.354 in	
Tightening torque		0.4-0.6 Nm (3.5-5.3 lb.in)	
Environmental data			
Ambient temperature ranges	storage	-40...+80 °C	
	operation	-20...+70 °C	
Isolation data			
Rated insulation voltage U _i (IEC/EN 60950-1, EN 50178)		4000 V RMS	
Rated impulse withstand voltage U _{imp} (EN 50178)	input / output	4000 V RMS (RB122A: 3800 V RMS, RB111AR: 3500 V RMS)	
	shock coil / output	4000 V RMS	
	output / output	1000 V RMS	

Interface relays R600 range

Dimensional drawings, Load limit curves

All interface relays of R600 range

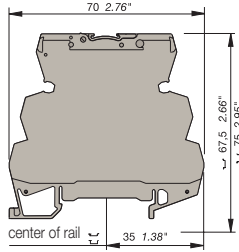

Screw clamp module

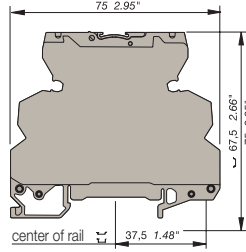

Spring clamp module

Load limit curves

RB 111 A, RB 111 AI, RB 111 AR, RB 101 AR,
 RB 121 AR, RB 121 AI, RB 121 AI (gold plated), RB 121 AI
 RB 121 (gold plated), RB 121 A (gold plated), RB 121, RB 121 A

Load limit curve RB ... 122A (gold plated)

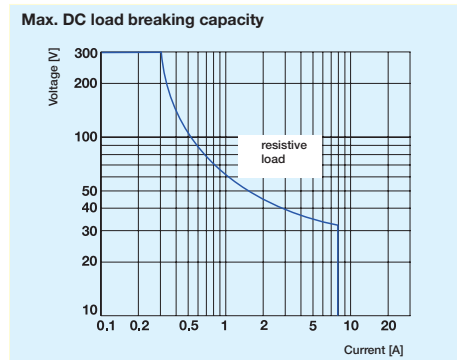
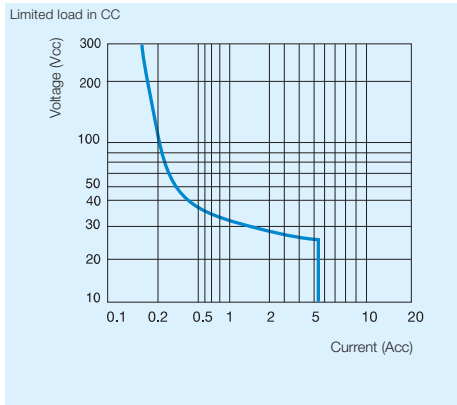

	DC12	AC12	DC13	AC15
24 V	6 A	6 A	1	3 A
110/120 V	0,3 A	6 A	0,2 A	3 A
220/230 V	0,2 A	6 A	0,1 A	3 A

Optocouplers R600 range
Product group picture

5



Optocouplers R600 range

Table of contents

Optocouplers R600 range	
Product group picture	5/63
Table of contents	5/64
Selection	5/65
Ordering details	5/67
Connection diagrams	5/68
Technical data	5/69

Optocouplers R600 range Selection

Type	Order number
OBIC 0100 5-12VDC	1SNA 645 047 R0000
OBIC 0100 5-12VDC	1SNA 645 547 R0200
OBIC 0100 24VDC	1SNA 645 021 R2600
OBIC 0100 24VDC	1SNA 645 521 R2000
OBIC 0100 48-60VAC/DC	1SNA 645 049 R1200
OBIC 0100 48-60VAC/DC	1SNA 645 549 R1400
OBIC 0100 115-230VAC/DC	1SNA 645 022 R2700
OBIC 0100 115-230VAC/DC	1SNA 645 522 R2100
OBOC 1000-5-12VDC	1SNA 645 050 R1700
OBOC 1000-5-12VDC	1SNA 645 550 R1100
OBOC 1000-24VDC	1SNA 645 051 R0400
OBOC 1500-24VAC/DC	1SNA 645 025 R2200
OBOC 5000-24VDC	1SNA 645 024 R2100
OBOC 1000-24VDC	1SNA 645 551 R0600
OBOC 1500-24VAC/DC	1SNA 645 525 R2400
OBOC 5000-24VDC	1SNA 645 524 R2300
OBOC 1000-48-60VAC/DC	1SNA 645 053 R0600
OBOC 1000-48-60VAC/DC	1SNA 645 553 R0000
OBOC 1000-115VAC/DC	1SNA 645 054 R0700
OBOC 5000-115VAC/DC	1SNA 645 058 R1300
OBOC 1000-115VAC/DC	1SNA 645 554 R0100
OBOC 5000-115VAC/DC	1SNA 645 558 R1500
OBOC 1000-230VAC/DC	1SNA 645 026 R2300
OBOC 5000-230VAC/DC	1SNA 645 059 R1400
OBOC 1000-230VAC/DC	1SNA 645 526 R2500
OBOC 5000-230VAC/DC	1SNA 645 559 R1600
OBOA 1000-24VDC	1SNA 645 027 R2400
OBOA 2000-24VDC	1SNA 645 029 R0600
OBOA 1000-24VDC	1SNA 645 527 R2600
OBOA 2000-24VDC	1SNA 645 529 R0000

Input voltage	OBIC 0100 5-12VDC	OBIC 0100 5-12VDC	OBIC 0100 24VDC	OBIC 0100 24VDC	OBIC 0100 48-60VAC/DC	OBIC 0100 48-60VAC/DC	OBIC 0100 115-230VAC/DC	OBIC 0100 115-230VAC/DC	OBOC 1000-5-12VDC	OBOC 1000-5-12VDC	OBOC 1000-24VDC	OBOC 1500-24VAC/DC	OBOC 5000-24VDC	OBOC 1000-24VDC	OBOC 1500-24VAC/DC	OBOC 5000-24VDC	OBOC 1000-48-60VAC/DC	OBOC 1000-48-60VAC/DC	OBOC 1000-115VAC/DC	OBOC 5000-115VAC/DC	OBOC 1000-115VAC/DC	OBOC 5000-115VAC/DC	OBOC 1000-230VAC/DC	OBOC 5000-230VAC/DC	OBOC 1000-230VAC/DC	OBOC 5000-230VAC/DC	OBOA 1000-24VDC	OBOA 2000-24VDC	OBOA 1000-24VDC	OBOA 2000-24VDC		
5 - 12 V DC	■	■							■	■																						
24 V DC			■	■							■	■	■	■	■	■																
48 - 60 V DC					■	■																										
115 - 230 V DC							■	■																								
115 V DC																				■	■	■	■									
230 V DC																																
24 V AC												■			■																	
48 - 60 V AC					■	■																										
115-230 V AC							■	■																								
115 V AC																				■	■	■	■									
230 V AC																																

Output rating	OBIC 0100 5-12VDC	OBIC 0100 5-12VDC	OBIC 0100 24VDC	OBIC 0100 24VDC	OBIC 0100 48-60VAC/DC	OBIC 0100 48-60VAC/DC	OBIC 0100 115-230VAC/DC	OBIC 0100 115-230VAC/DC	OBOC 1000-5-12VDC	OBOC 1000-5-12VDC	OBOC 1000-24VDC	OBOC 1500-24VAC/DC	OBOC 5000-24VDC	OBOC 1000-24VDC	OBOC 1500-24VAC/DC	OBOC 5000-24VDC	OBOC 1000-48-60VAC/DC	OBOC 1000-48-60VAC/DC	OBOC 1000-115VAC/DC	OBOC 5000-115VAC/DC	OBOC 1000-115VAC/DC	OBOC 5000-115VAC/DC	OBOC 1000-230VAC/DC	OBOC 5000-230VAC/DC	OBOC 1000-230VAC/DC	OBOC 5000-230VAC/DC	OBOA 1000-24VDC	OBOA 2000-24VDC	OBOA 1000-24VDC	OBOA 2000-24VDC		
100 mA	■	■	■	■	■	■	■	■																								
2 A											■	■	■	■	■	■																
5 A													■																			
1 A																																

Output voltage	OBIC 0100 5-12VDC	OBIC 0100 5-12VDC	OBIC 0100 24VDC	OBIC 0100 24VDC	OBIC 0100 48-60VAC/DC	OBIC 0100 48-60VAC/DC	OBIC 0100 115-230VAC/DC	OBIC 0100 115-230VAC/DC	OBOC 1000-5-12VDC	OBOC 1000-5-12VDC	OBOC 1000-24VDC	OBOC 1500-24VAC/DC	OBOC 5000-24VDC	OBOC 1000-24VDC	OBOC 1500-24VAC/DC	OBOC 5000-24VDC	OBOC 1000-48-60VAC/DC	OBOC 1000-48-60VAC/DC	OBOC 1000-115VAC/DC	OBOC 5000-115VAC/DC	OBOC 1000-115VAC/DC	OBOC 5000-115VAC/DC	OBOC 1000-230VAC/DC	OBOC 5000-230VAC/DC	OBOC 1000-230VAC/DC	OBOC 5000-230VAC/DC	OBOA 1000-24VDC	OBOA 2000-24VDC	OBOA 1000-24VDC	OBOA 2000-24VDC		
58 V DC	■	■	■	■	■	■	■	■	■	■	■	■	■	■	■	■	■	■	■	■	■	■	■	■	■	■	■	■	■	■	■	■
400 V AC																																

Terminal type	OBIC 0100 5-12VDC	OBIC 0100 5-12VDC	OBIC 0100 24VDC	OBIC 0100 24VDC	OBIC 0100 48-60VAC/DC	OBIC 0100 48-60VAC/DC	OBIC 0100 115-230VAC/DC	OBIC 0100 115-230VAC/DC	OBOC 1000-5-12VDC	OBOC 1000-5-12VDC	OBOC 1000-24VDC	OBOC 1500-24VAC/DC	OBOC 5000-24VDC	OBOC 1000-24VDC	OBOC 1500-24VAC/DC	OBOC 5000-24VDC	OBOC 1000-48-60VAC/DC	OBOC 1000-48-60VAC/DC	OBOC 1000-115VAC/DC	OBOC 5000-115VAC/DC	OBOC 1000-115VAC/DC	OBOC 5000-115VAC/DC	OBOC 1000-230VAC/DC	OBOC 5000-230VAC/DC	OBOC 1000-230VAC/DC	OBOC 5000-230VAC/DC	OBOA 1000-24VDC	OBOA 2000-24VDC	OBOA 1000-24VDC	OBOA 2000-24VDC		
Screw	■		■		■		■		■		■	■	■	■	■	■																
Spring		■		■		■		■		■		■	■	■	■	■																

Optocouplers R600 range Selection

OBOA 1000-48-60VAC/DC	1SNA 645 061 R0600
OBROA 1000-48-60VAC/DC	1SNA 645 561 R0000
OBOA 1000-115VAC/DC	1SNA 645 062 R0700
OBROA 1000-115VAC/DC	1SNA 645 562 R0100
OBOA 1000-230VAC/DC	1SNA 645 028 R0500
OBROA 1000-230VAC/DC	1SNA 645 528 R0700

Optocouplers R600 range

Ordering details



2CDC291 001 F0013

5

R600 Optocoupler	Type	Order code	Price	Pkg qty	Weight (1 pce) kg (lb)
Optocoupler module 100 mA/DC	OBIC 0100-5-12VDC	1SNA645047R0000		10	0.02 (0.44)
	OBIC 0100-24VDC	1SNA645021R2600			
	OBIC 0100-48-60VAC/DC	1SNA645049R1200			
Optocoupler module 100 mA/DC	OBIC 0100-115-230VAC/DC	1SNA645022R2700		10	0.02 (0.44)
	OBRIC 0100-5-12VDC	1SNA645547R0200			
	OBRIC 0100-24VDC	1SNA645521R2000			
Optocoupler module 100 mA/DC	OBRIC 0100-48-60VAC/DC	1SNA645549R1400		10	0.02 (0.44)
	OBRIC 0100-115-230VAC/DC	1SNA645522R2100			
	OBOC 1000-5-12VDC	1SNA645050R1700			
Optocoupler module 2 A/DC	OBOC 1000-24VDC	1SNA645051R0400		10	0.02 (0.44)
	OBOC 1500-24VAC/DC	1SNA645025R2200			
	OBOC 1000-48-60VAC/DC	1SNA645053R0600			
Optocoupler module 2 A/DC	OBOC 1000-115VAC/DC	1SNA645054R0700		10	0.02 (0.44)
	OBOC 1000-230VAC/DC	1SNA645026R2300			
	OBROC 1000-5-12VDC	1SNA645550R1100			
Optocoupler module 2 A/DC	OBROC 1000-24VDC	1SNA645551R0600		10	0.02 (0.44)
	OBROC 1500-24VAC/DC	1SNA645525R2400			
	OBROC 1000-48-60VAC/DC	1SNA645553R0000			
Optocoupler module 2 A/DC	OBROC 1000-115VAC/DC	1SNA645554R0100		10	0.02 (0.44)
	OBROC 1000-230VAC/DC	1SNA645526R2500			
	OBOC 5000-24VDC	1SNA645024R2100			
Optocoupler module 5 A/DC	OBOC 5000-115VAC/DC	1SNA645058R1300		10	0.02 (0.44)
	OBOC 5000-230VAC/DC	1SNA645059R1400			
Optocoupler module 5 A/DC	OBROC 5000-24VDC	1SNA645524R2300		10	0.02 (0.44)
	OBROC 5000-115VAC/DC	1SNA645558R1500			
Optocoupler module 5 A/DC	OBROC 5000-230VAC/DC	1SNA645559R1600		10	0.02 (0.44)
	OBOA 1000-24VDC	1SNA645027R2400			
Optocoupler module 1 A/AC 6 mm spacing	OBOA 1000-48-60VAC/DC	1SNA645061R0600		10	0.03 (0.066)
	OBOA 1000-115VAC/DC	1SNA645062R0700			
	OBOA 1000-230VAC/DC	1SNA645028R0500			
Optocoupler module 2 A/AC 12 mm spacing	OBOA 2000-24VDC	1SNA645029R0600		5	0.03 (0.066)
Optocoupler module 1 A/AC 6 mm spacing	OBROA 1000-24VDC	1SNA645527R2600		10	0.03 (0.066)
	OBROA 1000-48-60VAC/DC	1SNA645561R0000			
	OBROA 1000-115VAC/DC	1SNA645562R0100			
Optocoupler module 1 A/AC 6 mm spacing	OBROA 1000-230VAC/DC	1SNA645528R0700		10	0.03 (0.066)
	OBROA 2000-24VDC	1SNA645529R0000			

Accessories	Type	Order code	Price	Pkg qty	Weight (1 pce) kg (lb)
End section	BADH V0	1SNA116900R2700		50	
	BADL V0	1SNA399903R0200		50	
	BAM2 V0	1SNA399967R0100		50	
Seperator end section	SC 612	1SNA290474R0200		10	
Divisible shunt 10 poles	BJ 612-10	1SNA290488R0100		10	
Divisible shunt 20 poles	BJ 612-20	1SNA206754R0000		10	
Screw clamp distribution block sp. 12 mm	D4/12-3-3	1SNA645031R2000		5	
Spring clamp distribution block sp. 12 mm	D4/12-3R-3R	1SNA645531R2200		5	
Test plug DIA. 2 mm	FC2	1SNA645531R2200		10	
Marking method	RC65 / RC610	see marking			

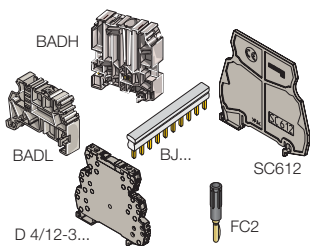

Optocouplers R600 range

Connection diagrams

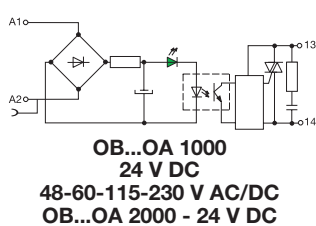
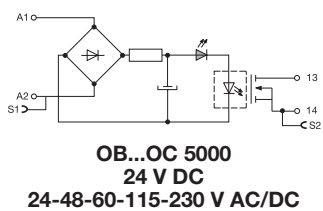
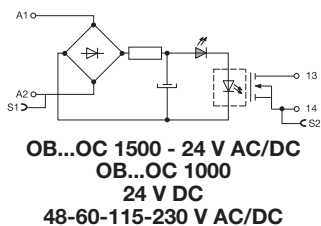
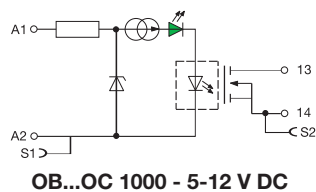
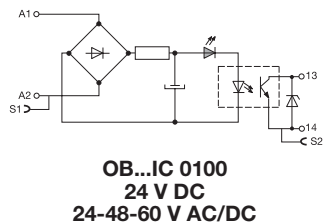
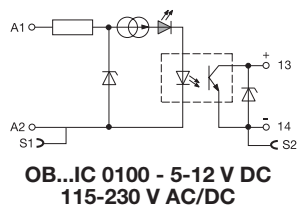





Optocouplers R600 range

Technical data

Technical data

Optocoupler : 5 to 58 V DC output / 100 mA - 6 mm 0.236" spacing

5

		OB...IC 0100					
Relay characteristics coil							
Input voltage: +20%, -15% on DC ; 10%, -10% on AC	5 V DC - 12 V DC	24 V DC		48 V AC/DC	60 V AC/DC	115 V AC/DC	230 V AC/DC
Frequency				50 / 60 Hz			
Input current AC/DC	5 mA	9 mA	4 mA	4 mA	5 mA	7 mA / 16 mA	11.5 mA / 25 mA
Pull-in voltage at I _s =100%	4 V		15 V	25 V	60 V AC / 70 V DC		
Switching time C / O	10 μs / 500 μs						
Operating frequency	1000 Hz			5 ms / 20 ms		5 ms / 15 ms	
Permissible leakage current				20 Hz			
Output	0.9 mA	1 mA		0.9 mA	1.6 mA		
Output voltage	4.5 to 58 V DC						
Output current min.	1 mA						
Output current max.	100 mA						
Output leakage current at U _{max}	< 50 μA						
Residual voltage at I max and U rated	typical	1 V					
	max	1.3 V					
Frequency on inductive load							
Isolation Input / Output	input / Output	2500 V RMS					
Temperature	storage	-40...+80 °C					
	operating	-20...+70 °C ¹⁾					
Other characteristics		Screw clamp			Spring clamp		
Body material	grey	UL 94 V0					
Wire size	Solid wire	0.2 - 4 mm ² (24-12 AWG)			0.2-2.5 mm ² (24-12 AWG)		
	Stranded wire	0.22 - 2.5 mm ² (24-12 AWG)					
Rated wire size	2.5 mm ² (12 AWG)						
Wire stripping length	9 mm (0.354 in)						
Recommended screwdriver	3.5 mm (0.137 in)						
Protection	IP20 NEMA1						
Recommended torque	0.4-0.6 Nm (3.5-5.3 lb.in)						
Approvals	c  US (pending for 12 V DC) ,  (pending) ,  , LRS , 						
Reference standards	CEI 947-7-1 / CEI 947-1 / CEI 1131-2 (in relevant parts) / CEI 60664-1 / CEM : IEC 1000-4-2, 3, 4, 5, 6.						

¹⁾ Over 55°C, blocks have to be mounted on horizontal rail with 10 mm spacing between each block. For vertical rail mounting use temperature is 15°C less decreased.

Dimensional drawings

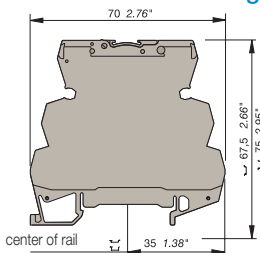

Screw clamp module

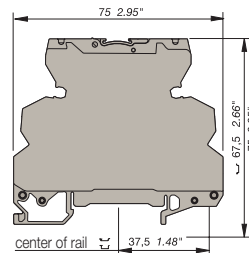





Spring clamp module

Optocouplers R600 range

Technical data

Technical data

Optocoupler : 5 to 58 V DC output / 2 A - 6 mm 0.236" spacing

	OB...OC 0100		OB..OC 1500	OB...OC 1000				
Relay characteristics coil								
Input voltage: +20%, -15% on DC ; 10%, -10% on AC	5 V DC - 12 V DC		24 V DC	24 V AC/DC	48 V AC/DC	60 V AC/DC	115 V AC/DC	230 V AC/DC
Frequency			50 / 60 Hz					
Input current	5 mA	9 mA	4 mA	6.3 mA	4 mA	5.1 mA	4.2 mA	4 mA
Pull-in voltage at Is=100%	4 V		15 V	15 V	27 V		50 V	80 V
Switching time C / O	15 µs / 250 µs		30 µs / 400 µs	1 ms / 7 ms	5 ms / 20 ms		500 µs / 10 ms	1 ms / 15 ms
Operating frequency	2000 Hz		1000 Hz	60 Hz	20 Hz			
Permissible leakage current	1 mA		0.8 mA	0.9 mA	1 mA		0.3 mA	
Output								
Output voltage	4.5 to 58 V DC							
Output current min.	1 mA							
Output current max.	2 A							
Output leakage current at U _{max}	< 50 µA							
Residual voltage at I max and U rated	typical		0.1 V					
	max		0.5 V					
Frequency on inductive load								
Isolation Input / Output	input / Output	2500 V RMS						
Temperature	storage		-40...+80 °C					
	operating		-20...+70 °C ¹⁾					
Other characteristics			Screw clamp			Spring clamp		
Body material	grey	UL 94 V0						
Wire size	Solid wire	0.2 - 4 mm ² (24-12 AWG)			0.2-2.5 mm ² (24-12 AWG)			
	Stranded wire	0.22 - 2.5 mm ² (24-12 AWG)						
Rated wire size	2.5 mm ² (12 AWG)							
Wire stripping length	9 mm (0.354 in)							
Recommended screwdriver	3.5 mm (0.137 in)							
Protection	IP20 NEMA1							
Recommended torque	0.4-0.6 Nm (3.5-5.3 lb.in)							
Approvals	c  us (pending for 12 V DC) ,  (pending) ,  , LRS , 							
Reference standards	CEI 947-7-1 / CEI 947-1 / CEI 1131-2 (in relevant parts) / CEI 60664-1 / CEM : IEC 1000-4-2, 3, 4, 5, 6.							

¹⁾ Over 55°C, blocks have to be mounted on horizontal rail with 10 mm spacing between each block. For vertical rail mounting use temperature is 15°C less decreased.

Dimensional drawings

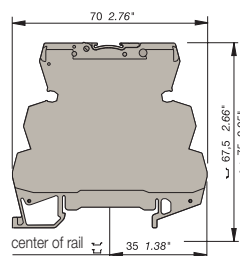

Screw clamp module

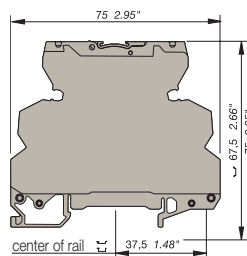



Spring clamp module

Optocouplers R600 range

Technical data

Technical data

Optocoupler : 5 to 58 V DC output / 5 A - 6 mm 0.236" spacing

		OB... OC 5000		
Input				
Input voltage	24 V DC	115 V AC/DC	230 V AC/DC	
Frequency		50 / 60 Hz	50 / 60 Hz	
Input current	5.4 mA	4.2 mA	4 mA	
Pull-in voltage at Is=100%	12 V	50 V	80 V	
Switching time C / O	30 µs / 400 µs	500 µs / 10 ms	1ms / 15 ms	
Operating frequency	1000 Hz	50 Hz	35 Hz	
Permissible leakage current	0.8 mA	0.3 mA	0.3 mA	
Output				
Output voltage	4.5- 58 V DC			
Output current min.	25 mA			
Output current max.	5 A			
Output leakage current at U _{max}	< 0.50 mA			
Residual voltage at I max and U rated	typical	1 V		
	max	1.6 V		
Frequency on inductive load	See Note 1			
Isolation Input / Output	input / Output	2500 V RMS		
Temperature				
Ambient temperature	storage	-40...+80 °C		
	operating	See derating curve		
Other characteristics				
Body material	grey	UL 94 V0		
Wire size	Solid wire	0.2 - 4 mm ² (24-12 AWG)		
	Stranded wire	0.22 - 2.5 mm ² (24-12 AWG)		
Rated wire size	2.5 mm ² (12 AWG)			
Wire stripping length	10 mm (0.394 in)			
Recommended screwdriver	3.5 mm (0.137 in)			
Protection	IP20 NEMA1			
Recommended torque	0.4-0.6 Nm (3.5-5.3 lb.in)			
Approvals	c  US (pending), 			
Reference standards	CEI 947-7-1 / CEI 947-1 / CEI 1131-2 (in relevant parts) / CEI 60664-1 / CEM : IEC 1000-4-2, 3, 4, 5, 6.			

Dimensional drawings

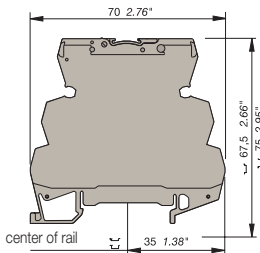

Screw clamp module

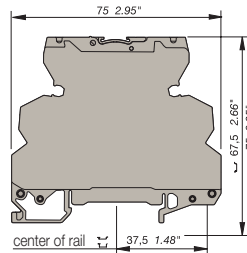





Spring clamp module

Optocouplers R600 range

Technical data

Technical data

Optocoupler : 24 to 400 V AC output / 2 A max. - 6 mm or 12 mm spacing

	OB...OA 1000					OB...OA 2000
Relay characteristics coil						
Input voltage: +20%, -15% on DC ; 10%, -10% on AC	24 V DC	48 V AC/DC	60 V AC/DC	115 V AC/DC	230 V AC/DC	24 V DC
Frequency		50/60 Hz				
Input current	3.6 mA	4.3 mA	5.5 mA	4.15 mA	4.6 mA	3.6 mA
Pull-in voltage at Is=100%	14 V	15 V	18 V	60 V	135 V	14 V
Switching time C / O	150 μ s / 1 ms	3 ms / 30 ms		2.2 ms / 18 ms	2.5 ms / 25 ms	150 μ s / 1 ms
Operating frequency	500 Hz	20 Hz		25 Hz	20 Hz	500 Hz
Permissible leakage current	1 mA					
Output						
Output voltage	24-400 V AC					
Frequency	50/60 Hz					
Output current min.	25 mA					
Output current max.	1 A					
Output leakage current at U _{max}	< 0.50 mA					
Residual voltage at I max and U rated	typical	1 V				
	max	1.6 V				
Frequency on inductive load						
Isolation Input / Output	input / Output	2500 V RMS				
Temperature	storage	-40...+80 °C				
	operating	-20...+70 °C ¹⁾				
Other characteristics		Screw clamp			Spring clamp	
Body material	grey	UL 94 V0				
Wire size	Solid wire	0.2 - 4 mm ² (24-12 AWG)			0.2-2.5 mm ² (24-12 AWG)	
	Stranded wire	0.22 - 2.5 mm ² (24-12 AWG)				
Rated wire size		2.5 mm ² (12 AWG)				
Wire stripping length		9 mm (0.354 in)				
Recommended screwdriver		3.5 mm (0.137 in)				
Protection		IP20 NEMA1				
Recommended torque		0.4-0.6 Nm (3.5-5.3 lb.in)				
Approvals		 us (pending for 12 V DC) ,  (pending),  , LRS , 				
Reference standards		CEI 947-7-1 / CEI 947-1 / CEI 1131-2 (in relevant parts) / CEI 60664-1 / CEM : IEC 1000-4-2, 3, 4, 5, 6.				

¹⁾ Over 55°C, blocks have to be mounted on horizontal rail with 10 mm spacing between each block. For vertical rail mounting use temperature is 15°C less decreased.

Dimensional drawings

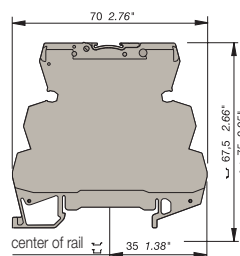

Screw clamp module

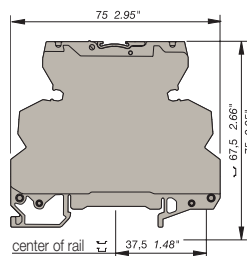

Spring clamp module

Terminal blocks component holder

Base for pluggable plug
R500 Series

DIN 3

End stop		th. 9 mm	BADL	V0	1SNA 399 903 R0200
End stop		th. 9,1 mm	BAM	V2	1SNA 103 002 R2600
End stop		th. 9,1 mm	BAM V0	V0	1SNA 199 306 R0300
Rail		35 x 7,5 x 1	PR3.Z2		1SNA 174 300 R1700
Rail		35 x 15 x 2,3	PR4		1SNA 168 500 R1200
Rail		35 x 15 x 1,5	PR5		1SNA 168 700 R2200

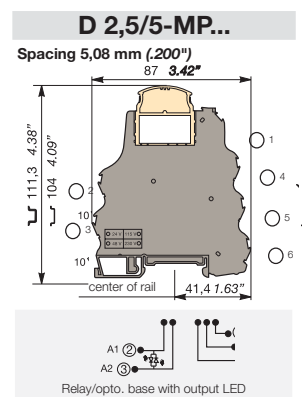
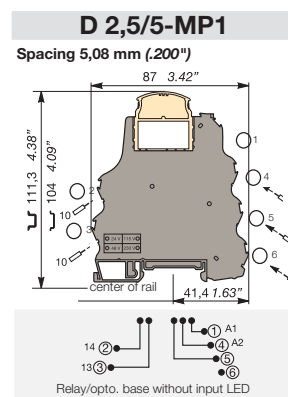
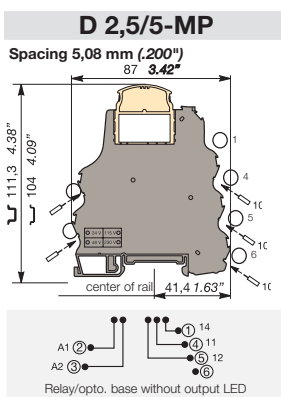

Observations

Terminal blocks are delivered without plugs.

Max. working temperature
version without LED : 100°C
version with LED : 85°C
Contact resistance : < 5 mΩ

Characteristics

		IEC		UL/CSA pending		IEC		UL/CSA pending		IEC		UL/CSA pending			
Wire size	Compression clamp	Solid wire		0,2-4 mm ²		24-12 AWG		0,2-4 mm ²		24-12 AWG		0,2-4 mm ²		24-12 AWG	
	Stranded wire	0,22-2,5 mm ²		24-12 AWG		320 V		300 V		0,22-2,5 mm ²		24-12 AWG		300 V	
Voltage	Rated	320 V		300 V		4 kV		300 V		4 kV		300 V		300 V	
	Pulse	4 kV		300 V		4 kV		300 V		4 kV		300 V		300 V	
	Pollution degree	3		300 V		3		300 V		3		300 V		300 V	
Current	Rated	6 A		6 A		6 A		6 A		6 A		6 A		6 A	
Wire size	Rated / Gauge	2,5 mm ²		12 AWG		2,5 mm ²		12 AWG		2,5 mm ²		12 AWG		12 AWG	
Wire stripping length		10 mm / .394"		10 mm / .394"		10 mm / .394"		10 mm / .394"		10 mm / .394"		10 mm / .394"		10 mm / .394"	
Recommended screwdriver		3,5 mm / .137"		3,5 mm / .137"		3,5 mm / .137"		3,5 mm / .137"		3,5 mm / .137"		3,5 mm / .137"		3,5 mm / .137"	
Recommended torque		0,4-0,6 Nm / 3,5-5,3 lb.in		0,4-0,6 Nm / 3,5-5,3 lb.in		0,4-0,6 Nm / 3,5-5,3 lb.in		0,4-0,6 Nm / 3,5-5,3 lb.in		0,4-0,6 Nm / 3,5-5,3 lb.in		0,4-0,6 Nm / 3,5-5,3 lb.in		0,4-0,6 Nm / 3,5-5,3 lb.in	
Protection		IP 20 / NEMA1		IP 20 / NEMA1		IP 20 / NEMA1		IP 20 / NEMA1		IP 20 / NEMA1		IP 20 / NEMA1		IP 20 / NEMA1	

Accessories

		Type	Part numbers		Type	Part numbers		Type	Part numbers	
	1 Test device	DCB (1) blue	1SNA105028R2100		DCB (1) blue	1SNA105028R2100		DCB (1) blue	1SNA105028R2100	
	2 Test plug	FC2 DIA. 2	1SNA007865R2600		FC2 DIA. 2	1SNA007865R2600		FC2 DIA. 2	1SNA007865R2600	
	3 Relay plug 1 SPDT 10 mA/6 A 1 SPDT 1 mA/6 A	BNMS R24V-1 beige	1SNA031820R1400		BNMS R24V-1 beige	1SNA031820R1400		BNMS R24V-1 beige	1SNA031820R1400	
	4 Input optocoupler plug 5 V DC 24 V DC 24 V DC 48 V DC 125 V DC 24 V AC 48 V AC 115 V AC 230 V AC	BNMS N24V-3 red	1SNA031807R1400		BNMS T5V-1 white	1SNA031831R0300		BNMS N24V-3 red	1SNA031807R1400	
	5 Output optocoupler plug 24 V DC/100 mA 24 V DC/100 mA 24 V DC/2 A 24 V DC/2 A 24 V DC/1 A 24 V DC/1 A 24 V DC/1 A	BNMS P24V-3 red	1SNA031810R1200		BNMS T24V-1 white	1SNA031848R2400		BNMS P24V-3 red	1SNA031810R1200	
	5 Output optocoupler plug 5 V DC/100 mA 5 V DC/100 mA 48 V DC/100 mA 48 V DC/100 mA 5 V DC/2 A 5 V DC/2 A 5 V DC/1 A 5 V DC/1 A	BNMS N5V-3 red	1SNA031806R1300		BNMS T24V-2 white	1SNA031800R2100		BNMS N5V-3 red	1SNA031806R1300	
	7 Fuse plug 125 V/125 mA 125 V/500 mA 125 V/2 A 125 V/5 A 250 V/125 mA 250 V/2 A 250 V/5 A 125 V/125 mA 250 V/125 mA 125 V/2 A	BNMS F125mA-1 grey	1SNA031821R0100		BNMS T48V-1 white	1SNA031801R1600		BNMS F125mA-1 grey	1SNA031821R0100	
	8 Strap plug	BNMS ST1 grey	1SNA031829R1100		BNMS T125V-1 white	1SNA031845R1100		BNMS ST1 grey	1SNA031829R1100	
	9 Converter plug 0-20 mA/0-10 V 4-20 mA/2-10 V 0-20 mA/0-5 V 4-20 mA/1-5 V	BNMS CAI/U-500 grey	1SNA031832R0400		BNMS T115V-1 yellow	1SNA031804R1100		BNMS CAI/U-500 grey	1SNA031832R0400	
	10 Comb type jumper bar 10 poles R See section on marking	PCMS V0 (2) RC 55	1SNA205523R2200		BNMS T230V-1 yellow	1SNA031805R1200		PCMS V0 (2) RC 55	1SNA205523R2200	

(1) Solely on the top stage. (2) Comb type jumper bar from 2 to 22 poles, see accessories.

Input optocoupler plugs

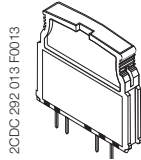

DC plugs

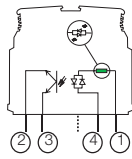

Derating curve

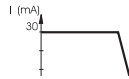

AC plugs

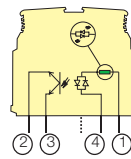

Derating curve

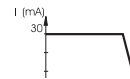

Switching time R_L curve 1
for 24 V DC plugs only

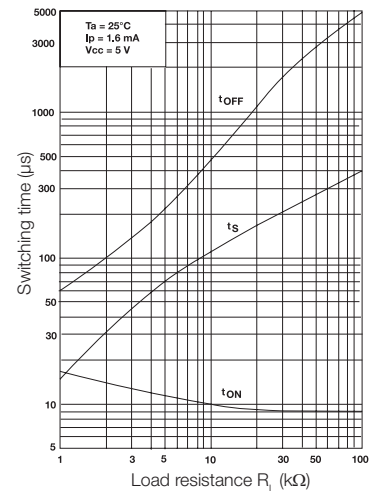

Part number	5 V DC		24 V DC		48 V DC		125 V DC	
	Type	P/N	Type	P/N	Type	P/N	Type	P/N
	BNMS T5V-1	1SNA031831R0300	BNMS T24V-1	1SNA031800R2100	BNMS T48V-1	1SNA031801R1600	BNMS T125V-1	1SNA031845R1100
			BNMS T24V-2	1SNA031848R2400				
Characteristics								
INPUT			BNMS T24V-1	BNMS T24V-2				
Voltage	4,5 V to 5,5 V DC		19,2 V to 27,6 V DC		38,4 V to 55,2 V DC		93,5 V to 140 V DC	
Max. current	6 mA		5 mA		4,1 mA		3 mA	
Typical triggering threshold at $I_S = 100\%$	3,5 V		12 V DC		21 V DC		50 V DC	
Switching time	C/O	20 μs / 1,3 ms	20 μs / 1,3 ms	10 μs / see curve 1	20 μs / 1,3 ms		20 μs / 1,3 ms	
Leakage current			1 mA		0,8 mA			
OUTPUT								
Max. voltage. / Max. current	58 V / 30 mA		58 V / 30 mA	58 V / 5 mA	58 V / 30 mA		58 V / 30 mA	
Residual voltage max. I and rated U standard	2,3 V DC		2,3 V DC	0,3 V DC	2,3 V DC		2,3 V DC	
max.	2,7 V DC		2,7 V DC	0,5 V DC	2,7 V DC		2,7 V DC	
Compatibility			TTL					
Input / Output isolation	2,5 kV		2,5 kV		2,5 kV		2,5 kV	
TEMPERATURE								
Storage	- 30°C to + 80°C		- 30°C to + 80°C		- 30°C to + 80°C		- 30°C to + 80°C	
Operating	- 20°C to + 55°C		- 20°C to + 55°C		- 20°C to + 55°C		- 20°C to + 55°C	
Part number	24 V AC		48 V AC		115 V AC		230 V AC	
	Type	P/N	Type	P/N	Type	P/N	Type	P/N
	BNMS T24V-1	1SNA031802R1700	BNMS T48V-1	1SNA031803R1000	BNMS T115V-1	1SNA031804R1100	BNMS T230V-1	1SNA031805R1200
Charateristics								
INPUT								
Voltage	20,4 V to 26,4 V AC		40,8 V to 52,8 V AC		98 V to 126,5 V AC		195,5 V to 253 V AC	
Max. current	8,5 mA		4,5 mA		8 mA		7 mA	
Typical triggering threshold at $I_S = 100\%$	13 V AC		22 V AC		50 V AC		95 V AC	
Switching time	C/O	6 ms / 10 ms	6 ms / 10 ms		6 ms / 10 ms		6 ms / 10 ms	
Leakage current	1 mA		1 mA		2 mA		2 mA	
OUTPUT								
Max. voltage / Max. current	58 V / 30 mA		58 V / 30 mA		58 V / 30 mA		58 V / 30 mA	
Residual voltage max. I and rated U standard	2,3 V DC		2,3 V		2,3 V		2,3 V	
max.	2,7 V DC		2,7 V		2,7 V		2,7 V	
Input / Output isolation	2,5 kV		2,5 kV		2,5 kV		2,5 kV	
TEMPERATURE								
Storage	- 30°C to + 80°C		- 30°C to + 80°C		- 30°C to + 80°C		- 30°C to + 80°C	
Operating	- 20°C to + 55°C		- 20°C to + 55°C		- 20°C to + 55°C		- 20°C to + 55°C	

Transistor output optocoupler plugs

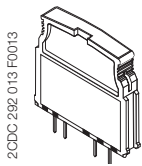

2CDC 202 013 F0013

100 mA output optocoupler 5 V DC

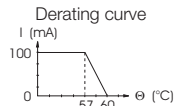
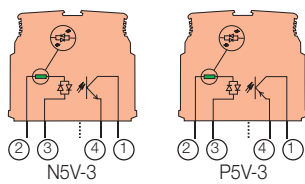

100 mA output optocoupler 24 V DC

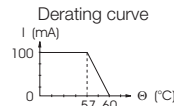
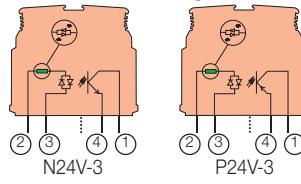

100 mA output optocoupler 48 V DC

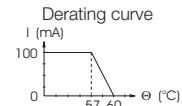
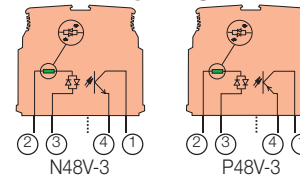

Part numbers	Type	P/N	Type	P/N	Type	P/N
	BNMS N5V-3	1SNA031806R1300	BNMS N24V-3	1SNA031807R1400	BNMS N48V-3	1SNA031808R2500
	BNMS P5V-3	1SNA031809R2600	BNMS P24V-3	1SNA031810R1200	BNMS P48V-3	1SNA031811R0700
Characteristics						
INPUT						
Voltage	4,5 V to 5,5 V DC		20,4 V to 28,8 V DC		40,8 V to 57,6 V DC	
Max. current	8,5 mA		4,8 mA		3,9 mA	
Typical triggering threshold at I _s = 100 %	2,9 V DC		16 V DC		26 V DC	
Switching time	C/O	20 μs / 1,3 ms	20 μs / 1,3 ms		20 μs / 1,3 ms	
Leakage current	1 mA		1 mA		1 mA	
OUTPUT						
Max. voltage / Max. current	58 V / 100 mA		58 V / 100 mA		58 V / 100 mA	
Residual voltage max. I and rated U	1 V DC		1 V DC		1 V DC	
standard U	1,3 V DC		1,3 V DC		1,3 V DC	
max.	See Note 1		See Note 1		See Note 1	
Frequency on inductive load	2,5 kV		2,5 kV		2,5 kV	
Input / Output isolation						
TEMPERATURE						
Storage	- 30°C to + 80°C		- 30°C to + 80°C		- 30°C to + 80°C	
Operating	- 20°C to + 60°C		- 20°C to + 60°C		- 20°C to + 60°C	

MOS output optocoupler plugs

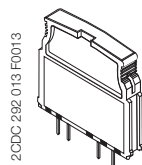

2CDC 202 013 F0013

1 A output optocoupler 5 V DC

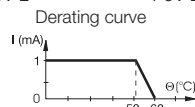
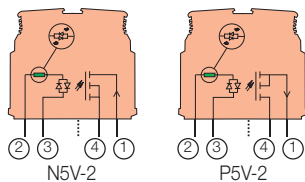

1 A output optocoupler 24 V DC

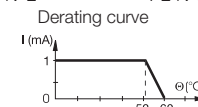
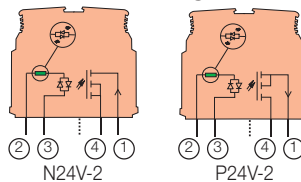

Note 1 :

$$F_{max} = (1 - 0,007 \times U_s) / (L \times I_s^2)$$

or

$$F_{max} = (1 - 0,007 \times U_s) / (P \times \frac{L}{R})$$

U_s = Output voltage supply
I_s = Output current
L = Inductive load
P = Load power
R = Load resistance

Part numbers	Type	P/N	Type	P/N
	BNMS N5V-2	1SNA031816R0400	BNMS N24V-2	1SNA031817R0500
	BNMS P5V-2	1SNA031818R1600	BNMS P24V-2	1SNA031819R1700
Characteristics				
INPUT				
Voltage	4,5 V to 5,5 V DC		20,4 V to 28,8 V DC	
Max. current	12,5 mA		6,7 mA	
Typical triggering threshold at I _s =100%	3,5 V DC		10 V DC	
Switching time	C/O	20 μs / 250 μs	50 μs / 350 μs	
Leakage current	1 mA		1 mA	
OUTPUT				
Max. voltage / Max. current	58 V / See graphs		58 V / See graphs	
Residual voltage max. I and rated U	1 V DC		1 V DC	
standard U	1,3 V DC		1,3 V DC	
max.	See Note 1		See Note 1	
Frequency on inductive load	2,5 kV		2,5 kV	
Input / Output isolation				
TEMPERATURE				
Storage	- 30°C to + 80°C		- 30°C to + 80°C	
Operating	- 20°C to + 60°C		- 20°C to + 60°C	

MOS output optocoupler plug

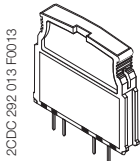

2CDC 292 013 F0013

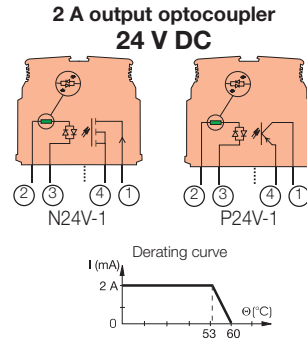
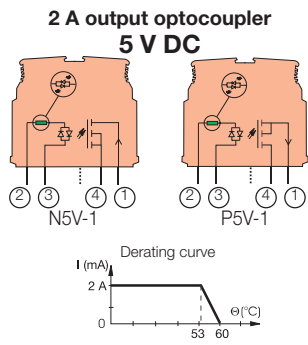

Note 2 :

$$F_{max} = (1 - 0,012 \times U_s) / (L \times I_s^2)$$

or

$$F_{max} = (1 - 0,012 \times U_s) / (P \times \frac{1}{R})$$

U_s = Output voltage supply
 I_s = Output current
 L = Inductive load
 P = Load power
 R = Load resistance

Part numbers	Type	P/N	Type	P/N
	BNMS N5V-1	1SNA031812R0000	BNMS N24V-1	1SNA031813R0100
	BNMS P5V-1	1SNA031814R0200	BNMS P24V-1	1SNA031815R0300
Characteristics				
INPUT				
Voltage	4,5 V to 5,5 V DC		20,4 V to 28,8 V DC	
Max. current	12,5 mA		6,7 mA	
Typical triggering threshold	3,5 V DC		10 V DC	
Switching time	C/O	20 μ s / 250 μ s	50 μ s / 350 μ s	
Leakage current	1 mA		1 mA	
OUTPUT				
Max. voltage / Max. current	30 V DC / See graphs		30 V / See graphs	
Residual voltage max. I and rated U				
standard U	1 V DC		1 V DC	
max.	1,3 V DC		1,3 V DC	
Frequency on inductive load	See Note 2		See Note 2	
Input / Output isolation	2,5 kV		2,5 kV	
TEMPERATURE				
Storage	- 30°C to + 80°C		- 30°C to + 80°C	
Operating	- 20°C to + 60°C		- 20°C to + 60°C	

Triac output optocoupler plug

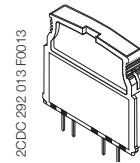

2CDC 292 013 F0013

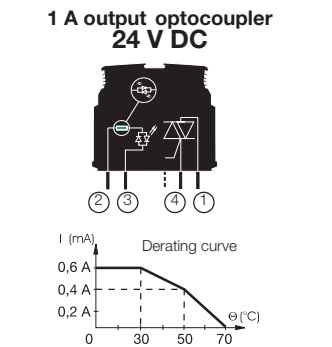

Part numbers	Type	P/N
	BNMS A24V-4	1SNA031839R1300
Characteristics		
INPUT		
Voltage	20,4 V to 28,8 V DC	
Max. current	3,8 mA	
Typical triggering threshold	10 V DC	
Switching time	C/O	9,5 ms / 12 ms
Leakage current		
OUTPUT		
Max. voltage / Max. current	24 V to 253 V AC / See derating curve	
Residual voltage max. I and rated U		
standard U	1 V AC	
max.	1,3 V AC	
Input / Output isolation	2,5 kV	
TEMPERATURE		
Storage	- 30°C to + 80°C	
Operating	- 20°C to + 70°C	

Relay plugs

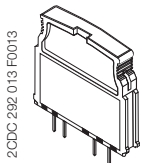

2CDC 292 013 F0013

1 SPDT relay

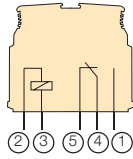

R24V-1

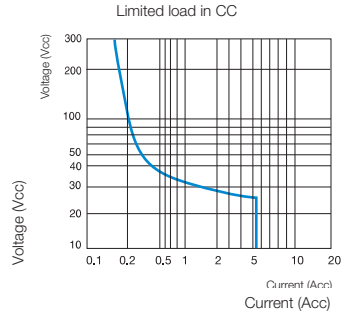
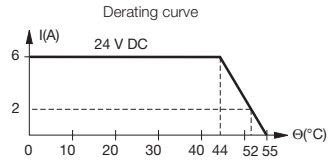

	DC12	AC12	DC13	AC15
24 V	6 A	6 A	1 A	3 A
110/120 V	0,3 A	6 A	0,2 A	3 A
220/230 V	0,2 A	6 A	0,1 A	3 A

Part numbers

Type	P/N
BNMS R24V-1	1SNA031820R1400
BNMS R24V-2	1SNA031847R1300

Characteristics

	BNMS R24V-1	BNMS R24V-2
COIL		
Voltage	20,4 V to 28,8 V DC	
Current max.	7 mA	
Trip voltage	1,2 V	
CONTACT		
Type	1 SPDT	
Voltage mini. / max.	12 V / 250 V	5 V / 250 V
Switching current mini. / max.	10 mA / 6 A	1 mA / 6 A
Switching current AC1 mini. / max.	0,6 VA/1500 VA (resistance)	0,05 VA/1500 VA (resistance)
Switching current DC1 mini. / max.	0,6 W / 140 W	0,05 W / 140 W
Number of operations on load	10 ⁸ operations for AC15	
Number of operations off load	10x10 ⁶ operations	
Operating speed C/O	6 ms / 8 ms	
Bounce	1,5 ms	
Isolation Coil / Contact	4 kV	
Resistance to shock waves Coil / Contact	4 kV	
Isolation Contact / Contact	1 kV	
TEMPERATURE		
Storage	- 40°C to + 80°C	
Operating	- 20°C to + 55°C	

Analogical plugs

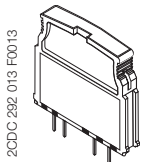

2CDC 292 013 F0013

Current / Voltage Converter

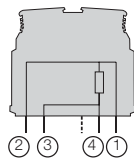

Plug with 250 Ω accuracy resistance for analogical signals.

Current / Voltage Converter

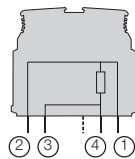

Plug with 500 Ω accuracy resistance for analogical signals.

Part numbers

Type	P/N	Type	P/N
BNMS CA I/U-250	1SNA031832R0400	BNMS CA I/U-500	1SNA031833R0500

Characteristics

	250 Ω	500 Ω
Resistance	250 Ω	500 Ω
Power	0,35 W	0,35 W
Accuracy	0,1 %	0,1 %
Stability	25 ppm	25 ppm

Fuse and strap plugs

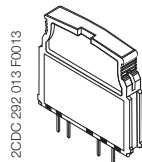

2CDC 292 013 F0013

Output fuse plug

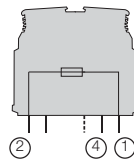

Input fuse plug

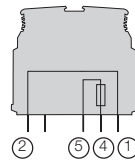

Strap plug

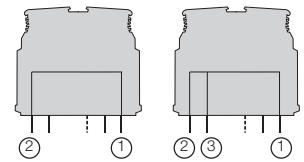

Part numbers

Type	P/N	Type	P/N	Type	P/N
BNMS F125mA-1	125 V / 125 mA 1SNA031821R0100	BNMS F125mA-3	125 V / 125 mA 1SNA031827R0700	BNMS ST1	1SNA031829R1100
BNMS F500mA-1	125 V / 500 mA 1SNA031838R1200	BNMS F125mA-4	250 V / 125 mA 1SNA031828R1000	BNMS ST2	1SNA031830R1600
BNMS F2A-1	125 V / 2 A 1SNA031822R0200				
BNMS F5A-1	125 V / 5 A 1SNA031823R0300				
BNMS F125mA-2	250 V / 125 mA 1SNA031824R0400				
BNMS F2A-2	250 V / 2 A 1SNA031825R0500				
BNMS F5A-2	250 V / 5 A 1SNA031826R0600				



BADL



BAM2

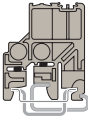

BAMH



BADH



PR30

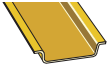

PR3.Z2

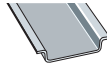

PR3.G2



PR5



PR4



FC2

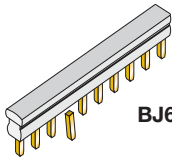

BJ612-...

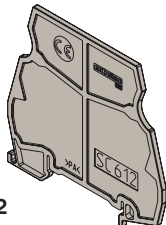

SC612

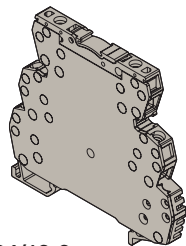

D4/12-3...

End stops

The end stops are mounted at the extremity of the terminal board assembly, giving additional support to the terminal blocks as markers. For various types of marking, refer to the marker section.

Description	Type	Order P/N	Packaging Weight kg	
End stop DIN 3	grey V0	BADL 9 mm	1SNA399903R0200	50
End stop with screws DIN 3	grey V0	BAM2 V0 10 mm	1SNA399967R0100	50
	grey V2	BAM2 10 mm	1SNA206351R1600	50
	beige V0	BAM2 V0 10 mm	1SNA296351R0000	50
	High end stop with screws DIN 1 and DIN 3	grey	BAMH 9,1 mm	1SNA114836R0000
High end stop with screws DIN 3	beige V0	BAMH V0 9,1 mm	1SNA194836R0100	50
	grey	BADH 12 mm	1SNA116900R2700	50

Mounting rails

Symmetrical zinc bichromate plated steel prepunched rail	PR30 2 m	1SNA173220R0500	1
Symmetrical zinc bichromate plated steel rail	PR3.Z2 2 m	1SNA174300R1700	1
White, symmetrical passivated galvanized steel rail	PR3.G2 2 m	1SNA164800R0300	1
Symmetrical zinc bichromate plated steel rail	PR5 2 m	1SNA168700R2200	1
Symmetrical zinc bichromate plated steel rail	PR4 2 m	1SNA168500R1200	1

Test devices

Test plug DIA. 2 mm	FC2	1SNA007865R2600	10
---------------------	-----	-----------------	----

Assembled jumper bar

This accessory permits electrical connection between 2 to 70 blocks with 6 mm spacing placed side by side. It can be used with screw clamp or spring clamp blocks with 6 mm or 12 mm spacing. Interconnection of blocks not placed side by side is possible if teeth of the jumper bar have been cut in front of the blocks not to be connected. These teeth can be removed using pliers. Use of separator end sections before and after the jumper bar is required to preserve IP20 protection of the assembly.

Assembled jumper bar 10 poles - 24 A	BJ612-10	1SNA290488R0100	10
Assembled jumper bar 20 poles - 24 A	BJ612-20	1SNA206754R0000	10

Separator end section

Directly mounted on the rail beside the block, it permits to identify and make electrical insulation of product groups using jumper bars. Dimensions are the same as screw clamp blocks : width 70 mm and height on rail 67,5 mm with 2 mm spacing.

Separator end section	SC612	1SNA290474R0200	10
-----------------------	-------	-----------------	----

Distribution module

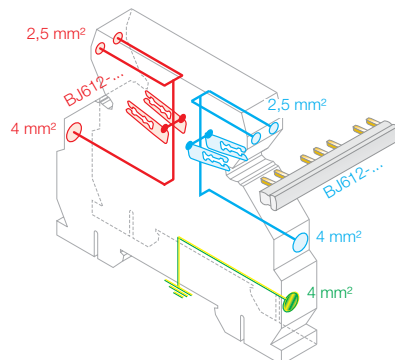

This terminal block with BJ612-... jumper bars permits 2 polarities distribution (PCL side and process side) thanks to two separate circuits, each of them including :

- one 4 mm² input,
- two 2,5 mm² outputs
- one double output for jumper bar BJ612-...

It permits also the connection of ground to the rail though a 4 mm² input.

Rated voltage : 250 VAC-DC
 Rated current : 32 A (4 mm²) - 16 A (2,5 mm²)
 Recommended torque : 0,4 - 0,6 Nm

Screw clamp distribution block sp. 12 mm	D4/12-3-3	1SNA645031R2000	5
Spring clamp distribution block sp. 12 mm	D4/12-3R-3R	1SNA645531R2200	5

Accessories

PCMS

Comb-type jumper

This accessory permits the electrical connection of 2 to 22 blocks.

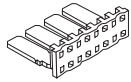

No. of poles	Grey UL94V0	Red UL94V0	Blue UL94V0	Green/Yellow UL94V0
2	1SNA205491R2300	1SNA205492R2400	1SNA205493R2500	1SNA205494R2600
3	1SNA205495R2700	1SNA205496R2800	1SNA205497R2900	1SNA205498R3000
4	1SNA205499R3100	1SNA205500R3200	1SNA205501R3300	1SNA205502R3400
5	1SNA205503R3500	1SNA205504R3600	1SNA205505R3700	1SNA205506R3800
6	1SNA205507R3900	1SNA205508R4000	1SNA205509R4100	1SNA205510R4200
7	1SNA205511R4300	1SNA205512R4400	1SNA205513R4500	1SNA205514R4600
8	1SNA205515R4700	1SNA205516R4800	1SNA205517R4900	1SNA205518R5000
9	1SNA205519R5100	1SNA205520R5200	1SNA205521R5300	1SNA205522R5400
10	1SNA205523R5500	1SNA205524R5600	1SNA205525R5700	1SNA205526R5800
11	1SNA205527R5900	1SNA205528R6000	1SNA205529R6100	1SNA205530R6200
12	1SNA205531R6300	1SNA205532R6400	1SNA205533R6500	1SNA205534R6600
13	1SNA205535R6700	1SNA205536R6800	1SNA205537R6900	1SNA205538R7000
14	1SNA205539R7100	1SNA205540R7200	1SNA205541R7300	1SNA205542R7400
15	1SNA205543R7500	1SNA205544R7600	1SNA205545R7700	1SNA205546R7800
16	1SNA205547R7900	1SNA205548R8000	1SNA205549R8100	1SNA205550R8200
17	1SNA205551R8300	1SNA205552R8400	1SNA205553R8500	1SNA205554R8600
18	1SNA205555R8700	1SNA205556R8800	1SNA205557R8900	1SNA205558R9000
19	1SNA205559R9100	1SNA205560R9200	1SNA205561R9300	1SNA205562R9400
20	1SNA205563R9500	1SNA205564R9600	1SNA205565R9700	1SNA205566R9800
21	1SNA205567R9900	1SNA205568R10000	1SNA205569R10100	1SNA205570R10200
22	1SNA205571R10300	1SNA205572R10400	1SNA205573R10500	1SNA205574R10600

PEF

Identification label holders

Designed to hold RPEV label (see opposite).

PEF * 1SNA020568R0400

* Delivered with labels.

The label holders are removable and the labels can be changed easily.

• For mounting on PCB in a 3,7 mm diameter hole.

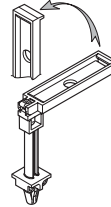

• For mounting on a PCB block in a 2 mm diameter hole (no support leg).

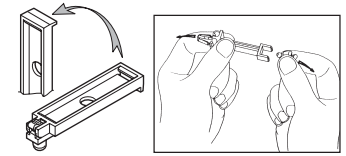

RPEV

Label for PEF 29 x 6 mm

Sheets of 99 pre-cut labels



✓ Blank RPEV 1SNA173178R0700

5

DC

Test device on screw head

This patented device is mounted on the round screwdriver opening. It is used for trouble shooting, measuring and control for monitoring and repairing an installation, on blocks without a test socket. For this, the device receives an FC2 test plug.



The DC's are differentiated by their colour :

blue for MA 2,5/5 blocks

DCB 1SNA105028R2100

PC

Comb-type jumper bar

PC EIP

This accessory can be used only on the terminal blocks with at least one compression clamp connection. It permits the electrical connection of 2 to 10 blocks.

Interconnection of non-consecutive blocks is possible by removing the teeth opposite the blocks which must not be connected. The comb-type jumper bars can be cut using pliers (or a saw) : in this case, the use of an insulating tip EIP is recommended. The comb is placed in the compression clamp before tightening the screws, above the eventual conductor.

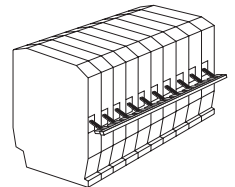

To be mounted on blocks series R900 and R910 :

Insulating tip for comb EIP 1SNA113550R2000
Comb-type jumper bar PC9 15 A 10 poles 1SNA210160R1200

BJ Jumper bar

BJS Jumper bar not assembled

To connect terminal blocks, place the metal tube into the top center hole on each terminal block to be connected.

The metal tube contacts the terminal block's internal connector bar.

The perforated bar is cut to length and placed flat along the center opening of the series of terminal blocks.

The screw is inserted into the perforated bar's hole which is located directly above the blocks being connected. The screw goes through the threaded metal tube and is screwed into the terminal block's internal connector bar. This completes the electrical connection to the perforated bar and connects the block.

To be mounted on blocks series R910 :

Screw + washer + post EV6D 1SNA168400R1600
Perforated jumper bar BJS9 32 A 8 poles 1SNA177583R1200
BJS9 32 A 16 poles 1SNA177584R1300

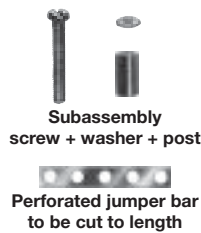

IDC jumper

(insulation displacement jumper)

Characteristics

Wire size mm ² / AWG	IEC		CSA
	NFC	VDE	
Rigid	2,5 mm ²	14 AWG	
Flexible	2,5 mm ²	14 AWG	
Voltage	600	600	
Current	26	15	
Rated wire size	mm ² / AWG	2,5 mm ² 14 AWG	
Working temperature	°C	-55°C -> +110°C	
Protection		IP20 / NEMA1	

Quick-jump lets you interconnect screw clamp terminals of different sizes, levels and all manufacturers quickly and safely. Its insulation displacement technology makes it easy to use, fast, economical and does not require a special tool. Use as a jumper between relays, switches and other electronic components. ABB Quick-jump will fit any screw clamp type terminal block, from 6 mm .238" spacing and larger.

How to use : connecting Quick-jump to your terminal

- 1 - Insert ABB Quick-jump into your terminal screw clamp.
- 2 - Tighten the terminal screw.
- 3 - Guide jumper wire through the V-shaped opening in the Quick-jump.
- 4 - Secure the wire by closing the Quick-jump lever with any flat nose pliers.

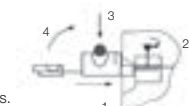
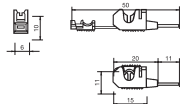

Adding a shunt in an installation :

- 1 - Insert ABB Quick-jump into your terminal screw clamp.
- 2 - Guide the terminal screw clamp into contact with the wire.
- 3 - Secure the wire by closing the Quick-jump lever with any flat nose pliers.
- 4 - Tighten the terminal screw.

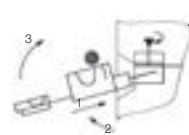

Insulation displacement jumper AD 2,5 1SNA114205R2000

RL Lengthwise marker

RLV Lengthwise marker
Width 9 mm .354"

Large area for writing.
To be snapped onto the top of blocks.

Blank marker for writing : RLV 1SNA103849R0300



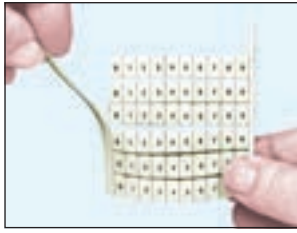

1

Remove one of the side bands of the card.



2

Separate the chosen strip from the rest of the card.



3

Press the first marker in place, hold it and slide your thumb on the rest of the strip.

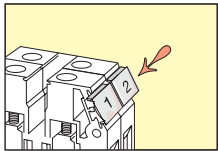

Horizontal marking

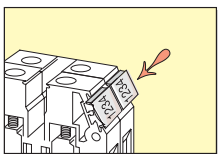

Vertical marking



Refilable box of 100 cards of 18 RC markers

Marking for Interface Modules

Selection table

Markers for modules :	RC610	RC55	RC65
R500			
R600		POSSIBLE	
R900			
R910		POSSIBLE	
R1800			

Possible mounting : **POSSIBLE**

Recommended mounting :

Impossible mounting :

Marking for terminal blocks

Standard RC marker cards

Marker sizes	<div style="display: flex; justify-content: space-around; font-size: small;"> (x) = Nb of cards in 5 mm spacing kit (x) = Nb of cards in 6 mm spacing kit (x) = Nb of cards in 6 mm spacing kit </div>		
	RC55	RC65	RC610
Blank cards	1SNA230000R1200	1SNA232000R0000	1SNA233000R0100
Horizontal marking			
10 strips from 1 to 10	1SNA230002R0000 (5)	1SNA232002R2600 (5)	1SNA233002R2700 (25)
10 strips from 11 to 20	1SNA230003R0100 (2)	1SNA232003R2700 (2)	1SNA233003R2000 (10)
10 strips from 21 to 30	1SNA230004R0200	1SNA232004R2000	1SNA233004R2100 (6)
10 strips from 31 to 40	1SNA230005R0300	1SNA232005R2100	1SNA233005R2200 (4)
10 strips from 41 to 50	1SNA230006R0400	1SNA232006R2200	1SNA233006R2300 (3)
10 strips from 51 to 60	1SNA230007R0500	1SNA232007R2300	1SNA233007R2400 (2)
10 strips from 61 to 70	1SNA230008R1600	1SNA232008R0400	1SNA233008R0500 (2)
From 1 to 100	1SNA230030R0700 (2)	1SNA232030R2500 (2)	1SNA233030R2600 (15)
From 101 to 200	1SNA230031R2400	1SNA232031R1200	1SNA233031R1300 (2)
20 times L1-L2-L3-N-PE	1SNA230131R2500	1SNA232131R1300	1SNA233131R1400 (2)
Vertical marking			
10 strips from 1 to 10	1SNA230041R0600	1SNA232041R2400	1SNA233041R2500 (5)
10 strips from 11 to 20	1SNA230042R0700	1SNA232042R2500	1SNA233042R2600 (3)
10 strips from 21 to 30	1SNA230043R0000	1SNA232043R2600	1SNA233043R2700 (2)
10 strips from 31 to 40	1SNA230044R0100	1SNA232044R2700	1SNA233044R2800 (2)
From 1 to 100	1SNA230060R1500	1SNA232060R0300	1SNA233060R0400 (6)

Marking kit RC 5 mm spacing or 6 mm spacing

Box with 100 cards with 18 various part numbers (see table next page)

Description	Type	Order P/N	Packaging Weight kg
Box with 100 cards RC 5 mm spacing		1SNA400085R2700	1
Refill for box RC 5 mm		1SNA400145R0700	1
Box with 100 cards RC 6 mm spacing		1SNA400084R2600	1
Refill for box RC 6 mm		1SNA400144R0600	1

X-ON Electronics

Largest Supplier of Electrical and Electronic Components

Click to view similar products for [General Purpose Relays](#) category:

Click to view products by [ABB](#) manufacturer:

Other Similar products are found below :

[APF30318](#) [JVN1AF-4.5V-F](#) [PCN-105D3MHZ](#) [5JO-10000S-SIL](#) [5JO-1000CD-SIL](#) [5JO-400CD-SIL](#) [LY2S-AC220/240](#) [LYQ20DC12](#)
[6031007G](#) [6131406HQ](#) [6-1393099-3](#) [6-1393099-8](#) [6-1393122-4](#) [6-1393123-2](#) [6-1393767-1](#) [6-1393843-7](#) [6-1415012-1](#) [6-1419102-2](#) [6-](#)
[1423698-4](#) [6-1608051-6](#) [6-1608067-0](#) [6-1616170-6](#) [6-1616248-2](#) [6-1616282-3](#) [6-1616348-2](#) [6-1616350-1](#) [6-1616350-8](#) [6-1616358-7](#) [6-](#)
[1616359-9](#) [6-1616360-9](#) [6-1616931-6](#) [6-1617039-1](#) [6-1617052-1](#) [6-1617090-2](#) [6-1617090-5](#) [6-1617347-5](#) [6-1617353-3](#) [6-1617801-8](#) [6-](#)
[1617802-2](#) [6-1618107-9](#) [6-1618248-4](#) [M83536/1-027M](#) [CX-4014](#) [MAHC-5494](#) [MAVCD-5419-6](#) [703XCX-120A](#) [7-1393100-5](#) [7-1393111-7](#)
[7-1393144-5](#) [7-1393767-8](#)