

## Mini Bulk Fastening Power Block

Marathon Special Products is proud to announce an addition to our [Power Terminal Block](#) product line. This addition will fill a void in the market for UL approved terminal block to distribute power at the high amperage and voltage levels. The Mini Bulk Fastening Power Block is available in many configurations to suit individual requirements. This product is ideal for power distribution options when terminating flexible stranded wire with crimp lugs or flexible bus bar.

### SPECIFICATIONS

- 1500V, up to 1500 amps
- 2 or 4 studs
- Complies to UL 1059
- cUL recognized component

### FEATURES

- Unique material allows 1500V UL rating
- SCCR 25ka rating with no over current protection device
- Hinged cover available
- Can be panel mounted over din rail

### BENEFITS

- Accommodates various power distribution options with listed lugs.
- Eliminates the need for self fabricated junction blocks in unique applications with large or unusual wiring combinations.
- Improved reliability or flexible stranded wire termination with listed lugs.
- Suitable to terminate and distribute power with flexible bus bar.







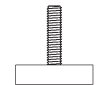

### APPLICATIONS

- Commercial HVAC
- Large motor controls
- Pumping and mining controls
- Solar (high voltage)
- Oil & Gas
- Stage lighting

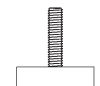
A Regal Brand

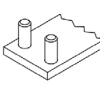
**REGAL**

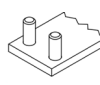
# MINI BULK FASTENING POWER BLOCK

Amps	Catalog #	Connector Temp. Rating	MATERIAL		LINE SIDE		LOAD SIDE		Agency Compliance
			Insulator	Conn	Wire Range AWG/kcmil	Connector Openings/Pole	Wire Range AWG/kcmil	Connector Openings/Pole	
750	HVPB112	90°C	Plastic	CU	Stud, 3/8	1 	Stud, 3/8	1 	UL Recognized (cURus)
750	HVPB114	90°C	Plastic	CU	Stud, 1/2	1 	Stud, 1/2	1 	UL Recognized (cURus)
1500	HVPB212	90°C	Plastic	CU	Stud, 3/8	2 	Stud, 3/8	2 	UL Recognized (cURus)
1500	HVPB214	90°C	Plastic	CU	Stud, 1/2	2 	Stud, 1/2	2 	UL Recognized (cURus)

## SINGLE WIDE PREPARED WIRE 750A FLEXIBLE BUS BAR 595A

DIMENSIONS ARE FOR THE 3/8" STUDS

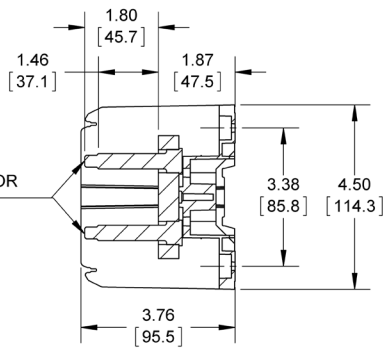

SECTION A-A

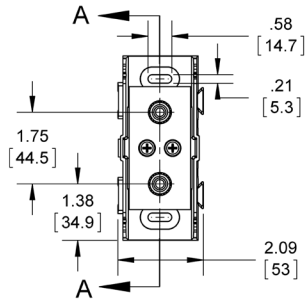

## DOUBLE WIDE PREPARED WIRE 1500A FLEXIBLE BUS BAR 985A

DIMENSIONS ARE FOR THE 1/2" STUDS

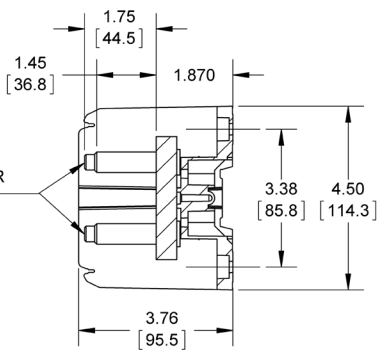

SECTION B-B

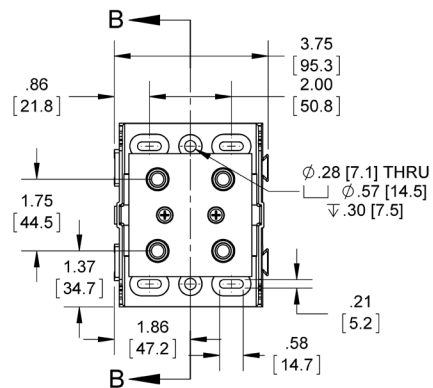

**marathon**™  
Special Products

427 Van Camp Road  
Bowling Green, Ohio 43402  
PH: 419-352-8441  
FAX: 419-352-0875

www.marathonsp.com

A Regal Brand

**REGAL**

www.regalbeloit.com

## X-ON Electronics

Largest Supplier of Electrical and Electronic Components

*Click to view similar products for [marathon manufacturer](#):*

Other Similar products are found below :

[104](#) [601-GP-2102-02](#) [601-GPYSY-03](#) [602-GPYSY-22](#) [603-2302-04](#) [603-JJ-04](#) [603-JJ-07](#) [604-JJ-06](#) [605-GP-03SLB](#) [605-JJ-02](#) [651-XPR-13](#)  
[670-3/4ST-9](#) [670A-GP-3000-18](#) [670A-GP-3000-25](#) [670A-GP-3000-27](#) [670A-GP-3/4ST-10](#) [670-GP-19](#) [CW205-01C](#) [671-RZ-25](#) [6F30A3S](#)  
[F600A1B](#) [F600A3B](#) [F60A1B](#) [FPB33588](#) [8TBJ02](#) [R30A1B](#) [RF400A3B](#) [1321970](#) [1322970CH](#) [1320972](#) [1331955](#) [1332270](#) [1332554CH](#)  
[1333280CH](#) [1333575CH](#) [1353701](#) [1353701CH](#) [1323474](#) [1331320CH](#) [1331552CH](#) [1332126CH](#) [1332272](#) [1332552](#) [1333360](#) [1333555CH](#)  
[1413403](#) [1402404](#) [1411403](#) [1422411](#) [1441551](#)