

multimec® 3F + 1D/1E/1F

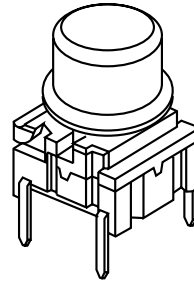

Technical Data:

- through-hole or SMD
- 50mA/24VDC
- single pole/momentary
- 10.000.000 operations life time
- IP67 sealing
- temperature range:
low temp: -40/+115°C
high temp: -40/+160°C

Dimensions (through-hole)

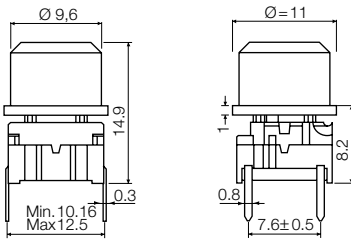

PCB layout

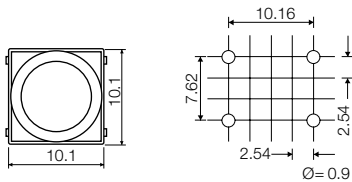

Dimensions (w/LED)

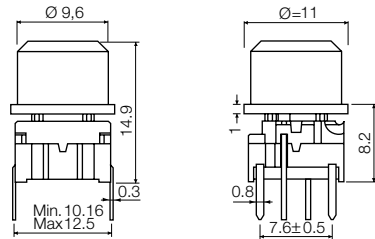

PCB layout (top view)

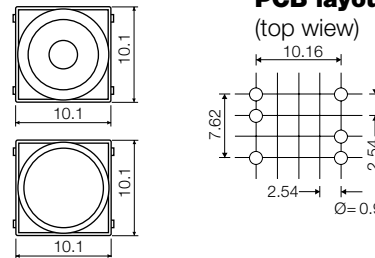

Dimensions (SMD)

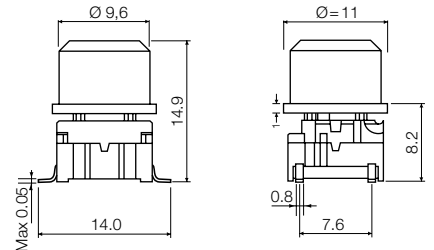

PCB layout

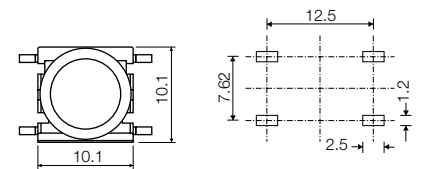



HOW TO ORDER

3 F	<input type="checkbox"/>	<input type="checkbox"/>	+	<input type="checkbox"/>	1 D	<input type="checkbox"/>	<input type="checkbox"/>	<input type="checkbox"/>
Switch	Mounting	L 6 low temp.		Cap	00 blue	30 ultra blue	50 metal dark blue	
	T through-hole	H 9 high temp.			02 green	40 dusty blue	53 metal light grey	
	S surface mount				03 grey	42 aqua blue	57 metal dark grey	
					04 yellow	32 mint green	58 metal bordeaux	
					06 white	33 tele grey		
					08 red	34 melon		
					09 black	38 noble red		

Standard versions:

3FTL6
3FTH9
3FSH9
3FSH9R

3 F	T	<input type="checkbox"/>	+	<input type="checkbox"/>	1 1	<input type="checkbox"/>
Switch	Mounting	L 6 low temp.		Cap 1D	transparent	Lens
	T through-hole	H 9 high temp.				
				Cap 1E	00 blue	1 transparent
					20 green	2 green
				Cap 1F	40 yellow	4 yellow
					80 red	8 red
					2040 green/yellow	
					8020 red/green	
					8040 red/yellow	
					03 grey	
					04 yellow	
					06 white	
					08 red	
					09 black	

Ordering example: 3FTL620 + 1E032

multimec® 3F + 1K + 2K

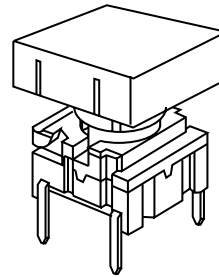
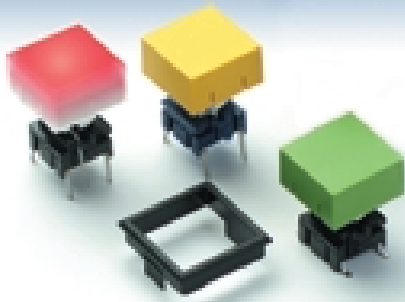

Technical Data:

- through-hole or SMD
- 50mA/24VDC
- single pole/momentary
- 10.000.000 operations life time
- IP67 sealing
- temperature range:
low temp: -40/+115°C
high temp: -40/+160°C

Dimensions (through-hole)

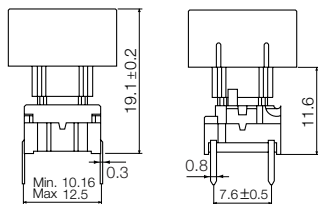

PCB layout

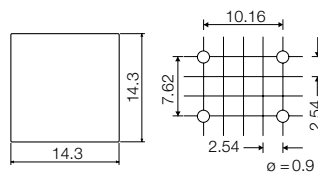

Dimensions (w/LED)

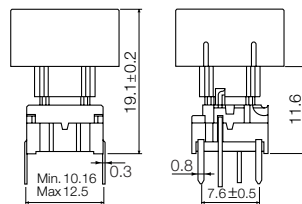

PCB layout (top view)

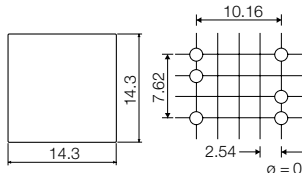

Dimensions (SMD)

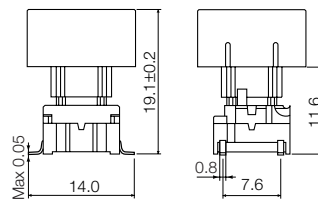

PCB layout

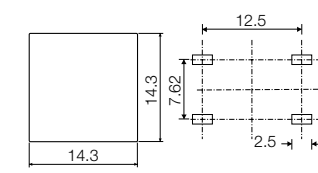

Dimensions (Bezel) (Optional)

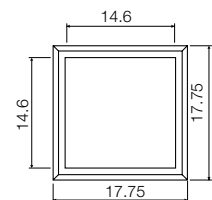
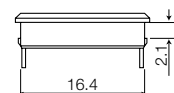

HOW TO ORDER

3 F	<input type="checkbox"/>	<input type="checkbox"/>	+	1 K	1 6	+	2 K	<input type="checkbox"/>
Switch	Mounting	L 6 low temp. H 9 high temp.		Cap	00 blue 02 green 03 grey 04 yellow 06 white 08 red 09 black		Bezel	03 grey 06 white 08 red 09 black

Standard versions:

- 3FTL6
- 3FTH9
- 3FSH9
- 3FSH9R

3 F	T	<input type="checkbox"/>	<input type="checkbox"/>	+	1 K 1 1 1 6	+	2 K	<input type="checkbox"/>
Switch	Mounting	L 6 low temp. H 9 high temp.	LED		Cap transparent		Bezel	03 grey 06 white 08 red 09 black
	T through-hole		23 green 44 yellow 88 red					

Standard versions:

- 3FTL622
- 3FTL644
- 3FTL688

Ordering example: 3FTL688 + 1K1116

multimec® 3F + 1P/1Q/1R

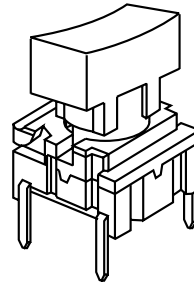

Technical Data:

- through-hole or SMD
- 50mA/24VDC
- single pole/momentary
- 10.000.000 operations life time
- IP67 sealing
- temperature range:
low temp: -40/+115°C
high temp: -40/+160°C

Dimensions (through-hole)

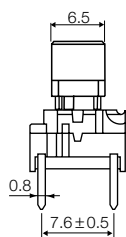
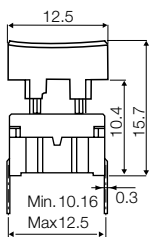

PCB layout

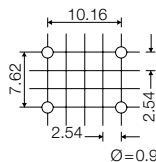
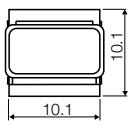

Dimensions (w/LED)

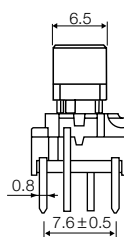
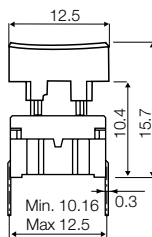

PCB layout (top view)

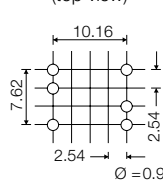
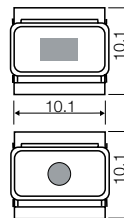

Dimensions (SMD)

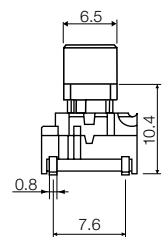
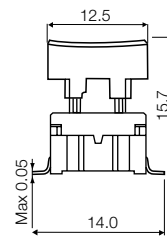

PCB layout

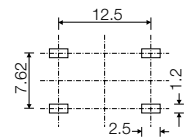
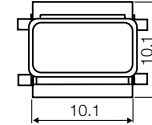

How to order

3 F

Switch



Mounting

T through-hole

S surface mount



L 6 low temp.
H 9 high temp.

+

1 P

Cap



00 blue
02 green
03 grey
04 yellow
06 white
08 red
09 black

Standard versions:

3FTL6
3FTH9
3FSH9
3FSH9R

3 F

Switch



Mounting

T through-hole



L 6 low temp.
H 9 high temp.



LED

00 blue
20 green
40 yellow
80 red
2040 green/yellow
8020 red/green
8040 red/yellow

+



1Q



00 blue
03 grey
08 red
09 black

1

Lens

1 transparent

Standard versions:

3FTL600
3FTL620
3FTL640
3FTL680
3FTL62040
3FTL68020
3FTL68040

1R



Ordering example: 3 FTL680 + 1Q091

multimec® RAS + 1D/1K/1P/1S



Technical Data:

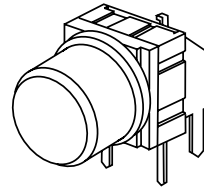

- through-hole only
- 50mA/24VDC
- single pole/momentary
- 10.000.000 operations life time
- IP67 sealing
- temperature range:
low temp: -40/+115°C

Dimensions 1D

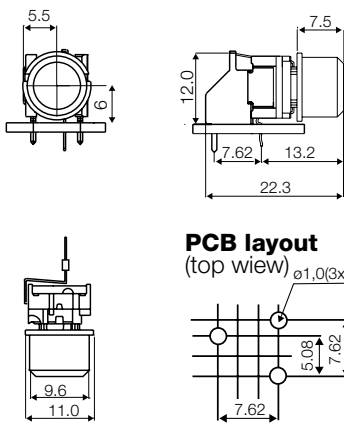

Dimensions 1K

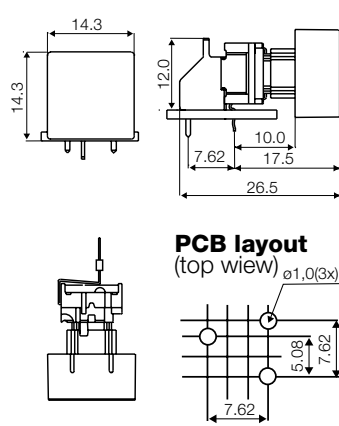

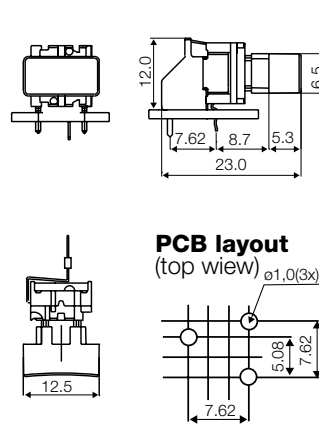

Dimensions 1P

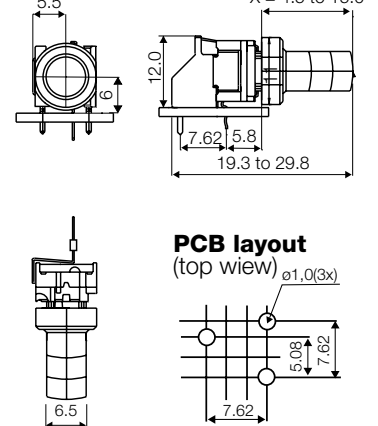

Dimensions 1S

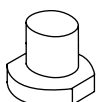

HOW TO ORDER

3 F	T	L 6	R A S	+	1 D			
Switch	Mounting	L 6 low temp.	Right angle support		Cap	00 blue	30 ultra blue	50 metal dark blue
	T through-hole					02 green	40 dusty blue	53 metal light grey
						03 grey	42 aqua blue	57 metal dark grey
						04 yellow	32 mint green	58 metal bordeaux
						06 white	33 tele grey	
						08 red	34 melon	
						09 black	38 noble red	
					1 P			
					Cap	00 blue		
						03 grey		
						08 red		
						09 black		
					1 K	1 6	+	2 K
					Cap	00 blue		Bezel
						02 green		03 grey
						03 grey		06 white
						04 yellow		08 red
						06 white		09 black
						08 red		
						09 black		
					1 S 0 9	-		.
					Cap black	H		X *
						16.0		8.5
						19.0		11.5
						22.5		15.0

Standard versions:
3FTL6RAS, 3CTL6RAS,

*Any cap height X from 8.5 to 15.0 mm is available. Please order 1S09-H, where H = X+7.5 mm
Min. order Qty for custom heights is 2.000 pcs. A start-up charge will apply.
3CTL6 also available as right angle switch 3CTL6RAS. Please see multimec basic switch modules.

Ordering example: 3FTL6RAS + 1K0016 + 2K03

Through-hole Version						
3A	3C	3E	3F	3F	3F	3F
For 1A/1B/1M	w/LED for 1C/1H			For 1D/1K/1N/1P/1S/1T/1U/1V/1X/1GA/1GC	w/LED for 1E/1F/1N/1Q/1R/1S/1X	w/LED for 1K1116/1T/1U/1V
Standard Versions						
3ATL6 3ATH9	3ATL600/20/40/80	3CTL6/3CTL9 3CTH9	3ETL9-H* 3ETH9-H*	3FTL6 3FTH9	3FTL600/20/40/80/ 2040/8020/8040	3FTL623/44/88
* 3E available in 6 standard heights: 08.0, 09.5, 10.4, 11.0, 12.0, 15.0 mm Other heights between 08.0 and 15.0 mm are available upon request						
Specials: Gold contacts, quiet version and actuation force other than 3.0N						

Surface Mount Versions			
3A	3C	3E	3F
3ASH9/3ASH9R	3CSH9/3CSH9R	3ESH9/3ESH9R	3FSH9 / 3FSH9R
For 1A/1B/1M			For 1D/1K/1N/1P/1S/1T/1U/1V/1X/1GA/1GC

Right Angle Versions	
3C	3F
3CTL6RAS	3FTL6RAS
	For 1D/1K/1P/1S

multimec® Cross Section

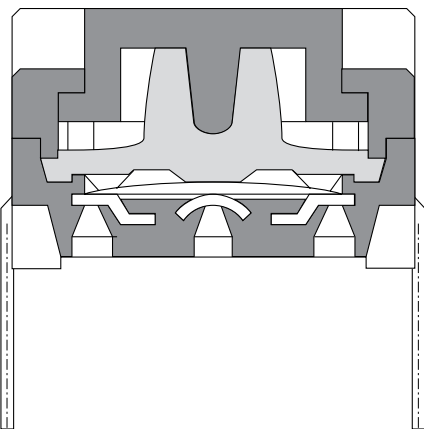

Recommended PCB layout

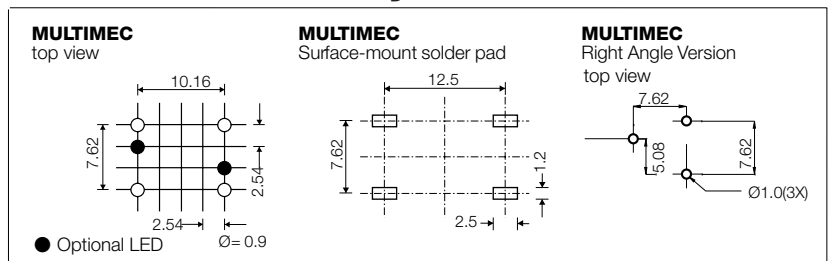

Operating Force (Typical example)

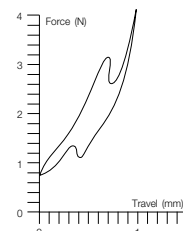

Circuit diagram

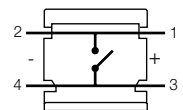

DIMENSIONS (mm) Unless otherwise specified, all tolerances ± 0.2

	Low Temperature Versions		High Temperature Versions	
	Silver	Gold	Silver	Gold
Electrical Specifications				
Contact resistance	<30 mΩ - typically 10mΩ			
Insulation resistance	>10M Ω			
Recommended load	0.5-50mA 24VDC	0.5μ-50mA 24VDC	0.5-50mA 24VDC	0.5μ-50mA 24VDC
Contact bounce	<2mS - typically 0.5mS			
Mechanical Specifications				
Standard actuation force (switch)	3.0N typ.			
Max. actuation force without cap	100N for 10 sec.			
Key travel (switch)	1 mm			
Life time (switch)	>10.000.000 cycles			
Temperature Range				
Working temperature	Min. -40°C Max. +115°C		Min. -40°C Max. +160°C	
Storage temperature	Min. -40°C Max. +115°C		Min. -40°C Max. +160°C	
Soldering IEC 68-2-20	Wave -max. 260°C for max. 10 sec., please refer to usage guidelines		Infrared, vapour phase, wave - max. 260°C for max. 30 sec.	
	Soldering iron - max. 350°C for max. 3 sec. Flux tight.		Soldering iron - max. 350°C for max. 3 sec. Flux tight.	
Environmental Endurance IEC-68-2-3				
Temperature	+40°C			
Humidity	93% RH			
Duration	56 Days			
Temperature Cycling IEC 68-2-14				
Temperature limit	Min. -55°C - Max. +85°C			
Number of cycles	200			
Exposure time at each temperature	10 min.			
Recovery time before measurements	16 hrs.			
Sealing IEC 529	IP-67			
Cleaning	Standard methods such as freon and water			
Material Specifications - Switches				
Housing	PBT UL94VO		PPS UL94VO	
Actuator	PBT UL94VO		PPS UL94VO	
Sealing + spring	Silicone rubber			
Contact spring	Stainless steel + 3μAg	Stainless steel + 3μAg + 1μAu	Stainless steel + 3μAg	Stainless steel + 3μAg + 1μAu
Fixed Contacts	SnCu + 2μNi + 3μAg	SnCu + 2μNi + 3μAg + 1μAu	SnCu + 2μNi + 3μAg	SnCu + 2μNi + 3μAg + 1μAu
Terminals	SnCu + 2μNi + 3μSnPb	SnCu + 2μNi + 3μSnPb	SnCu + 2μNi + 3μSnPb	SnCu + 2μNi + 3μSnPb
Material Specifications - Caps & Bezels				
Material	Parts	Temp limit	UL rating	
ABS Standard	Standard parts except the below mentioned	Max 65°C	UL94HB	
Polycarbonate	All lenses	Max. 85°C	UL94V1	
LCP	Actuator of 3E	Max. 160°C	UL94VO	
PPS	1S, 2S	Max. 160°C	UL94VO	
Polyamide	Actuator of Varimec , 1GA/ 1GC	Max. 160°C	UL94VO	
Legends Adhesion	ISO Class.: 1/ ASTM Class.: 4B DIN EN ISO 2409			

Specifications are subject to change without notice

**Existing and New Part Nos. for Lead Free, RoHS compatible and Proces compatible mec products
MULTIMEC**

Part No.	Part Name	Lead Free	RoHS Comp.	Proces Comp.	New Part No. Comments	Lead Free
3ASH9	Switch Surface Ag/High Temp	N	N	Y	RA3ASH9	Y
3AXXXG	All 3A Switches with Au	N	N	Y	RA3AXXXG	Y
3AXXXQ	All 3A Quiet Switches	N	N	Y	RA3AXXXQ	Y
3ASH9R	All 3A Switches delivered on Tape	N	N	Y	RA3ASH9R	Y
3ATH9	Switch Th Ag/High Temp.	N	N	Y	RA3ATH9	Y
3ATL6	Switch Th Ag/White But/Low Temp.	N	N	Y	RA3ATL6	Y
3ATL6 w/LED	Switch Th Ag/Low Temp w/LED	N	N	Y	RA3ATL6 w/LED	Y
3CSH9	Switch Surface Ag/High Temp.	N	N	Y	RA3CSH9	Y
3CXXXG	All 3C Switches with Au	N	N	Y	RA3CXXXG	Y
3CXXXQ	All 3C Quiet Switches	N	N	Y	RA3CXXXQ	Y
3CSH9R	All 3C Switches delivered on Tape	N	N	Y	RA3CSH9R	Y
3CTH9	Switch Th Ag/High Temp	N	N	Y	RA3CTH9	Y
3CTL6	Switch Th/White But/Low Temp	N	N	Y	RA3CTL6	Y
3CTL6-2SL	Switch Low Temp. 2 Straight Legs	N	N	Y	RA3CTL6-2SL	Y
3CTL6RAS	Right Angle Switch Low Temp.	N	N	Y	RA3CTL6RAS	Y
3CTL9	Switch Th Ag/Black But/Low Temp	N	N	Y	RA3CTL9	Y
3ESH9	Switch Surface Ag High Temp.	N	N	Y	RA3ESH9	Y
3ESH9-XX.X	Switch Ag/High Temp./w Actuator	N	N	Y	RA3ESH9-XX.X	Y
3EXXXG	All 3E Switches with Au	N	N	Y	RA3EXXXG	Y
3EXXXQ	All 3E Quiet Switches	N	N	Y	RA3EXXXQ	Y
3ESH9R	All 3E Switches delivered on Tape	N	N	Y	RA3ESH9R	Y
3ETH9	Switch Th Ag High Temp.	N	N	Y	RA3ETH9	Y

3ETH9-XX.X	Switch Th Ag/High Temp. w/Actuator	N	N	Y	RA3ETH9-XX.X	Y
3ETL9	Switch Th Ag/Low Temp.	N	N	Y	RA3ETL9	Y
3ETL9-XX.X	Switch Th Ag/Low Temp. w/Actuator	N	N	Y	RA3ETL9-XX.X	Y
3FSH9	Switch Surface Ag/High Temp.	N	N	Y	RA3FSH9	Y
3FXXXG	All 3F Switches with Au	N	N	Y	RA3FXXXG	Y
3FXXXQ	All 3F Quiet Switches	N	N	Y	RA3FXXXQ	Y
3FSH9R	All 3F Switches delivered on Tape	N	N	Y	RA3FSH9R	Y
3FTH9	Switch Th Ag/High Temp.	N	N	Y	RA3FTH9	Y
3FTH9 w/LED	Switch Th High Temp w/ LED	N	N	Y	RA3FTH9 w/LED	Y
3FTL6	Switch Th Ag/Low Temp.	N	N	Y	RA3FTL6	Y
3FTL6 w/LED	Switch Th Ag/Low Temp w/LED	N	N	Y	RA3FTL6 w/LED	Y
3FTL6-2SL	Switch Low Temp. 2 Straight Legs	N	N	Y	RA3FTL6-2SL	Y
3FTL6RAS	Right Angle Switch Low Temp.	N	N	Y	RA3FTL6RAS	Y
1CXXXX	Leds for 1C or 1H Button	N	N	N	RA1CXXXX	Y
2BXXXX	Leds for 2B Bezel	N	N	N	RA2BXXXX	Y
3FXXXXX	Leds Bent for 3F	N	N	N	RA3FXXXXX	Y
1AXX	DI Buttons all colours for 3A	Y	Y	N	No change, pls see note 1	
1BXX	DI Buttons f. Bezels all colours	Y	Y	N	No change, pls see note 1	
1CXXX	DI Buttons w/Lens all colours	Y	Y	N	No change, pls see note 1	
1DXX	Lk Buttons all colours	Y	Y	N	No change, pls see note 1	
1EXXX	Lk Buttons w/Lens all colours	Y	Y	N	No change, pls see note 1	
1FXXX	Lk Buttons w/Lens all colours	Y	Y	N	No change, pls see note 1	
1GA09	Cap black 11	Y	Y	Y	No change	
1GC09	Cap black 15	Y	Y	Y	No change	
1HXXX	DI Buttons w/Lens all colours	Y	Y	N	No change, pls see note 1	
1KXX	Lk Lid all colours	Y	Y	N	No change, pls see note 1	
1KXX16	Lid all colours/Lens/Reflector	Y	Y	N	No change, pls see note 1	

1KXX1	Lens Milky White For 1K Button	Y	Y	N	No change, pls see note 1
1KXXX6	Reflector For 1K Button White	Y	Y	N	No change, pls see note 1
1MXX	DI Button Double Width all colours	Y	Y	N	No change, pls see note 1
1NXX	Teardrop Buttons all colours	Y	Y	N	No change, pls see note 1
1PXX	Gf Buttons all colours	Y	Y	N	No change, pls see note 1
1QXXX	1P But. W/Square Hole, all colours	Y	Y	N	No change, pls see note 1
1RXXX	1P Button w/Round Hole, all colours	Y	Y	N	No change, pls see note 1
1S09-XX.X	Lk Button Black, all heights	Y	Y	Y	No change
1S11-XX.X	Lk Button Transparent, all heights	Y	Y	N	No change, pls see note 2
1TXX	Sq. Button, all colours	Y	Y	N	No change, pls see note 1
1UXX	Round Button, all colours	Y	Y	N	No change, pls see note 1
1VXX	Arrow Button, all colours	Y	Y	N	No change, pls see note 1
1X XX	Rectangular Button, all colours	Y	Y	N	No change, pls see note 1
1ZAXX	DL Button, all colours	Y	Y	N	No change, pls see note 1
1ZBXX	Curved Button, all colours	Y	Y	N	No change, pls see note 1
1ZCXX	Round Button, all colours	Y	Y	N	No change, pls see note 1
3E-XX.X	Actuator f. 3E Switch, all heights	Y	Y	Y	No change
3E-AXXXX	Varimec cap 5.2 Round, all heights	Y	Y	Y	No change
3E-BXXXX	Varimec cap 5.2 Square, all heights	Y	Y	Y	No change
3E-EXXXX	Varimec cap 7.8 Round, all heights	Y	Y	Y	No change
3E-FXXXX	Varimec cap 7.8 Square, all heights	Y	Y	Y	No change
3E-KXXXX	Varimec cap 11.6 Round, all heights	Y	Y	Y	No change
3E-LXXXX	Varimec cap 11.6 Square, all heights	Y	Y	Y	No change
AQB01XX	Sealing Boot (incl. Sea.ring)	Y	Y	Y	No change
AQB0111	Sealing Boot Trans. (incl. Sea.ring)	Y	Y	Y	No change
AQC09-XX.X	Cap Black, all overall heights	Y	Y	Y	No change
AQC11-XX.X	Cap Trans. all overall heights	Y	Y	N	No change, pls see note 2

AQN-X.X	Bushing, all heights	Y	Y	Y	No change
1CXXX	Lens f. 1C/1H/1Q Buttons, all colours	Y	Y	N	No change, pls see note 2
1EXXX	Lens f. 1E Buttons, all colours	Y	Y	N	No change, pls see note 2
1FXXX	Lens f. 1F Buttons, all colours	Y	Y	N	No change, pls see note 2
1RXX1	Round Transparent Lens For 1R	Y	Y	N	No change, pls see note 2
2AXX	DI Bezel, all colours	Y	Y	N	No change, pls see note 1
2BXXX	Bezel/Lens, all colours	Y	Y	N	No change, pls see note 1
2BXXX	Lens f. 2B Bezel, all colours	Y	Y	N	No change, pls see note 2
2KXX	Lk Bezel f. 1K, all colours	Y	Y	N	No change, pls see note 1
2RAS	Right Angle Support.	Y	Y	Y	No change
2S09-XX.X	Extender, Black Pps, all heights	Y	Y	Y	No change
1A09XDXXX	Button 1A Down/all legends	Y	Y	N	No change, pls see note 1
1A09UXXXX	Button 1A Up/all legends	Y	Y	N	No change, pls see note 1
1B09XDXXX	Button 1b Down/0	Y	Y	N	No change, pls see note 1
1B09UXXXX	Button 1B Up/all legends	Y	Y	N	No change, pls see note 1
1D09XXX	Round Button/all legends	Y	Y	N	No change, pls see note 1
1F096XXX	1F Button/Inverse legends	Y	Y	N	No change, pls see note 1
1ZB09XDXXX	Button1ZB09 Down / all legends	Y	Y	N	No change, pls see note 1
1ZC09XXX	Button 1ZC09 / all legends	Y	Y	N	No change, pls see note 1

Note 1: Complies with RoHS, however plastic material limited to 65°C.
Accessories must be mounted after soldering.

Note 2: Complies with RoHS, however plastic material is limited to 85°C,
so excessive proces heat must be avoided.

041213

041213

X-ON Electronics

Largest Supplier of Electrical and Electronic Components

Click to view similar products for [multimec](#) manufacturer:

Other Similar products are found below :

[CONKIT 1 THRO BOARD](#) [RA3CSH9](#) [1SS09-15.0](#) [CONKIT 3 THRO + MARKING](#) [5GSH935+1SS09-15.0](#) [2S09-07](#) [2S09-08](#) [1SS09-11.0](#)
[RA3ETH9-12-0](#) [1DS08](#) [1GCS09](#) [RA3FTH9](#) [1K0816](#) [1U08](#) [1JS09](#) [1U00](#) [1V03](#) [5GTH935+1SS09-09.5](#) [RA3ATH9](#) [1JS03](#) [RA3FTL98020](#)
[1JS16](#) [1B03](#) [1GAS09](#) [1S11-16](#) [1D06](#) [5GTH935](#) [2B031](#) [RA3ASH9](#) [1Q091](#) [RA3FTH987](#) [1B09](#) [5GTH935+1SS09-15.0](#) [5GTH93501](#) [1PS09](#)
[5GTH935+1SS09-11.0](#) [RA3FTH920](#) [1U03](#) [5GSH93522](#) [1T00](#) [RA3ETH9-09-5](#) [5GTH935RAS](#) [5GSH935+1SS09-12.0](#) [RA3FTH980](#) [2A09](#)
[RA3FTH9RAS](#) [5GTH93542](#) [1V09](#) [1K0916](#) [5ESH935](#)