

MASTER IXH - BGA REWORK-System

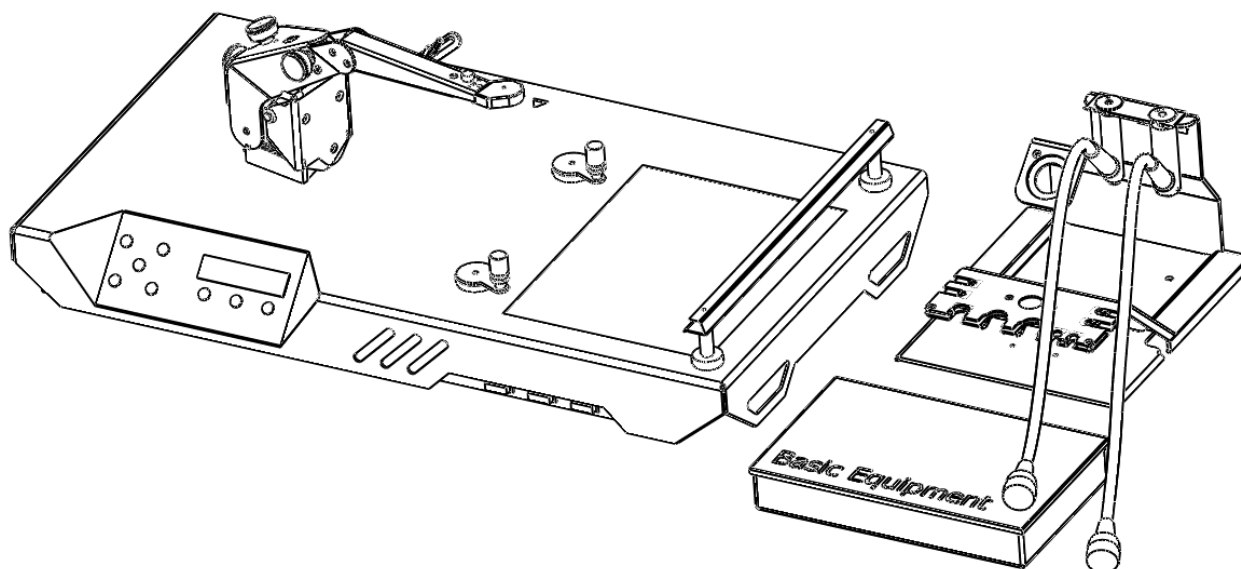

HXFA.4085 MASTER IXH

Desktop IXH BGA Rework System with Convection Top Heater and large Infrared Bottom Heater. Robust, designed for production environments, extremely reliable and very easy to operate.

The IXH handles all types of SMD's such as BGA / QFP / QFN / CSP. It performs all typical Rework process steps including component desoldering, component removal, site cleaning of residual solder, component replacement and component reflow.

Unique vision-free placement technology provided by STAR TOOLS ensures simple and reliable operation. Placement Tools never need calibration. The Hot Gas and Vacuum pens primarily used during the Rework process can also be used for a variety of heating and vacuum applications. EASY SOLDER rework software provides accurate control for the IXH, a Windows™ based platform that provides all necessary tools for successful Rework including Auto-Profiler with profile analysis and real-time plotting along with file management and reporting plus more...

Features



- SMD Solder Unit
- Smart Fix 02/ IRF 02-2000 Watt 230 V AC
- PCB Magnet Holder 2 pcs, PCB Magnet Holder Rail 1 pcs
- Soldering Pen with 7 pin plug, Vac module for Hot Air, Stand for pens / magazin
- Easy Solder 05 eco (Licence ES, CD, cable, manual)
- Positioning arm SHP (xyzd-axis), Power Cord Europe
- Basic equipment Master IXH:
Soldering sucker Nozzle 1,4mm, 0,7mm, Soldering Nozzle 7mm, 4mm, Calibration Tool for Solder Pen dist, Fuse Set, Filter Set, O-Ring Set, Placement nozzle 0,7mm, 6,3mm, 10mm, SMD Transportation Device for Positioning Arm, Flux Crème lead free, Clean Pen, Allen Screw Driver 2,0 and 2,5mm, Residual Solder Removal for Vacuum Pen

Technical Data

Power Consumption:	2500 VA
Power Solder Pen:	300 W, 35 l/min
Power Underheater:	500-2000 W, 4 x IR-lamps
Effective heating area:	185 x 245mm ²
Recommended max. PCB size:	200 x 260mm ²
Temperature Sensor Input:	2 pcs. Type K
Mains:	1Phase, 230VAC, fused 16A
Pressurized air:	5-8 bar (0,6psi), Dry, Clean (40µ filtered) air consumption: 100 l/min
Vacuum:	Not required (generated by compressed air)
Footprint:	660 x 360mm ²

MASTER IXH - BGA REWORK-System



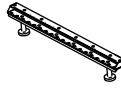
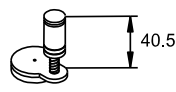
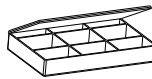







Scope of Delivery with MASTER IXH (HXFA.4085)

EB16.0002	Soldering pen with 7 pin plug		1 piece
SF42.0002	Positioning arm SHP (xyzd-axis) Single Head Placer for HB 08		1 piece
SF03.0010	PCB Magnet Holder Rail 40.5mm for IR/IRD/IRH/IRF/HIF and DL/RD		1 piece
SF03.0004	PCB Magnet Holder 40.5mm for IR/IRD/IRH/IRF/HIF and DL/RD		1 piece
HXFA.0022	Basic equipment MASTER IXH		1 piece

Solder Vac Nozzle 1,4mm & 0,7mm, Soldering Nozzle 7mm & 4mm, Calibration Tool for Solder Pen, Fuse Set, Filter& O-Ring Set

Placement nozzle 0,7mm, 6,3mm, 10mm, SMD Transportation Device for Positioning Arm, Flux Crème lead free, Clean Pen, Allen Screw Driver 2,0 and 2,5mm, Residual Solder Removal for Vac Pen







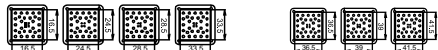



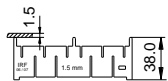

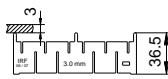











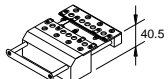





Optional Extras

LW40.0042	Placement Nozzle Star Tool 10mm for BGA >= 20mm and SHP		1 piece
LW40.0041	Placement Nozzle Star Tool 5mm for BGA >= 15mm and SHP		1 piece
LW39.1999	Star Tool set BGA 7 pieces (15, 23, 27, 31, 35, 37.5, 40)		1 piece
LW39.1916	Star Tool BGA 15*15mm placement tool for ASP/SHP arm		1 piece
LW39.1901	Star Tool BGA 23*23mm placement tool for ASP/SHP arm		1 piece
LW39.1900	Star Tool BGA 27*27mm placement tool for ASP/SHP arm		1 piece
LW39.1906	Star Tool BGA 31*31mm placement tool for ASP/SHP arm		1 piece
LW39.1909	Star Tool BGA 35*35mm placement tool for ASP/SHP arm		1 piece
LW39.1910	Star Tool BGA 37,5*37,5mm placement tool for ASP/SHP arm		1 piece
LW39.1911	Star Tool BGA 40*40mm placement tool for ASP/SHP arm		1 piece
LW39.1912	Star Tool BGA 42.5*42.5mm placement tool for ASP/SHP arm		1 piece







Star Tools are available for many SMD sizes. Please contact MARTIN for more Info.

LW40.1099	Solder Nozzle Set BGA 7 pieces (15, 23, 27, 31, 35, 27.5, 40)		1 piece
-----------	--	--	---------

MASTER IXH - BGA REWORK-System

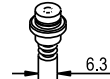
Optional Extras				
SF30.0004	PCB Support 40.5 1.5mm thickness			1 Pack (4 pcs)
SF30.0005	PCB Support 40.5 pcb=3mm (thickness)			1 Pack (4 pcs)
SF03.0014	PCB Magnet Holder Easy Lock 40.5 (snap)			1 piece
SF33.0010	PCB Magnet Holder Rail 40.5mm for IR/IRD/IRH/IRF/HIF and DL/RD			1 piece
SF01.0100	PCB Clip For Use With SF33.0010			1 piece
SF36.1003	PCB Fix Support 40.5 "4 pin" 350mm			1 piece
SF36.1001	PCB Flex Support 40.5mm "10 pin l=440mm			1 piece
SF03.0019	PCB Clamping Holder 40.5 with 3 for mobile phone pbc's			1 piece
LW10.0003	SMD Transportation Device for Positioning Arm			1 piece
HT00.0119	Flux Creme lead free 18g 0506 MA, no clean, RELO, with Brush			1 piece
HT00.0020	Brush for Flux Creme			1 piece
HT00.0019	Clean Pen for pads and IR Glass with 3 spare erasers			1 piece
HT00.0062	Kapton-Tape 19mm*5,5m			1 piece
PD91.0001	Foot Switch function start button			1 piece
HT00.0013	Sensor for Temperature K Type, D 0.1mm			1 piece

MASTER IXH - BGA REWORK-System

Optional Extras				
DV15.0010	Solder Sucker Nozzle 1.4 mm, Standard Type			1 piece
DB15.0012	Placement Nozzle 0,7 mm			1 piece
DB15.0014	SMD Placement Nozzle, 6,3 mm with rubber			1 piece
DB15.0021	Fine Filter for Vacuum Pen		Consumable Vacuum Pen	1 pack (6pcs)
DV15.0012	Solder separator for old solder standard type, 1.4 / 1.0 mm (with 5		Consumable Vacuum Pen	1 pack (20pcs)
DV15.0030	Flux filter for cooler of solder sucker nozzle		Consumable Vacuum Pen	1 pack (40pcs)

TECH INFO - VACUUM PEN

The Vacuum Pen is a tool from MARTIN Rework Systems. It is a multi functional tool which can be used to remove residual solder or to handle SMD components.

To protect the system vacuum generator the Vacuum Pen is equipped with several filter stages. They separate out the liquid solder and flux fume from the gas. The schematic diagrams below show the filters and cleaning procedures.

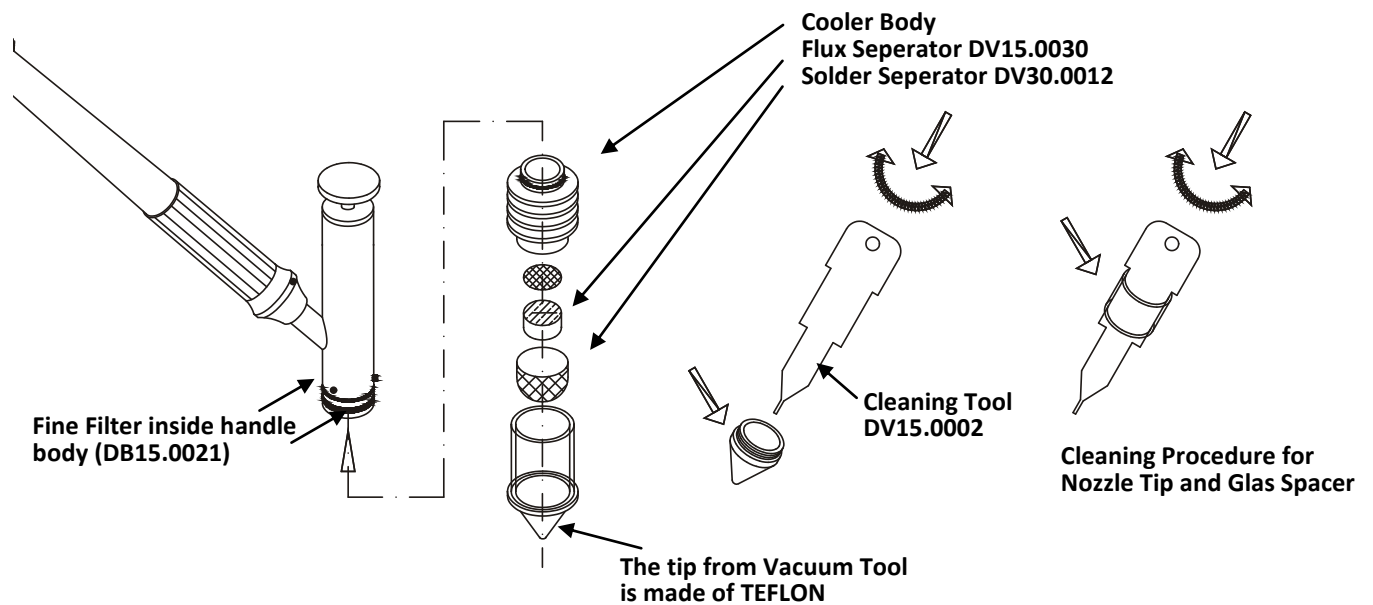
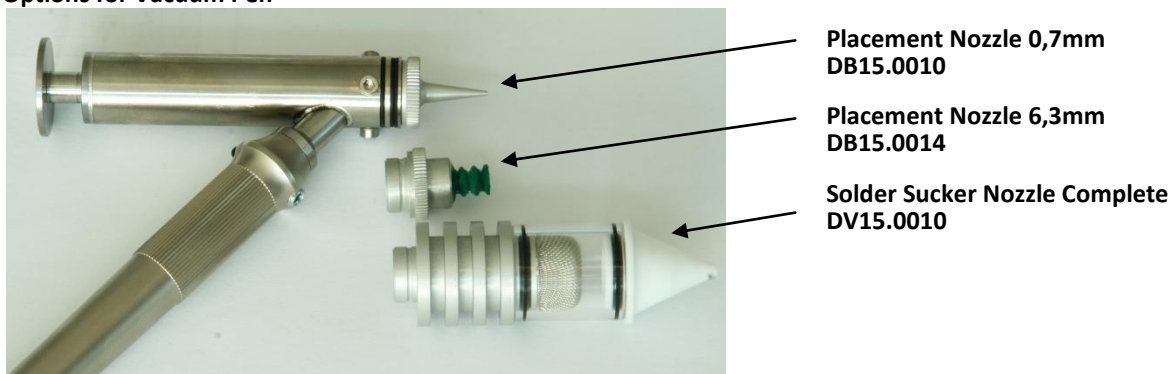

Photo from Vacuum Pen disassembled









Options for Vacuum Pen

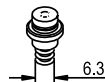

TECH INFO – VACUUM PEN

Anwendungssets

DV15.0010	Solder Sucker Nozzle 1.4 mm, Complete Standard Type		1 piece
DB15.0012	Placement Nozzle 0,7 mm		1 piece
DB15.0014	SMD Placement Nozzle, 6,3 mm with rubber		1 piece
DB15.0021	Fine Filter for Vacuum Pen		1 pack 6 pcs
DV15.0012	Solder separator for old solder Incl. 5 pcs filter net		1 pack 20pcs
DV15.0030	Flux filter for cooler of solder sucker nozzle		1 pack 40pcs

TECH INFO - STAR-TOOL PLACEMENT

STAR TOOL enables easy and vision-free placement of BGAs, QFPs and other surface mount devices for the Rework of even the most complicated and advanced PCBs.

STAR TOOL is easiest to use and simple in design, it has been proven in both production and development environments for many years. STAR TOOL technology an extremely robust and precise method used to align surface mount devices to PCB sites. Because of its unique mechanical approach, it never requires calibration or software driven controls.

Within 5 steps, operators are able to precisely place SMDs on PCBs with minimal training. Combined with the high performance MARTIN MASTER IXH REWORK system, complicated Rework is now made easy.

Step #1

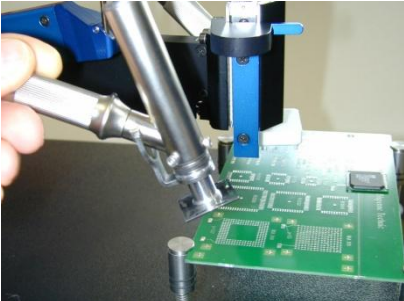

Load Vacuum Pen with stencil attached into SHP manipulator arm

Step #2

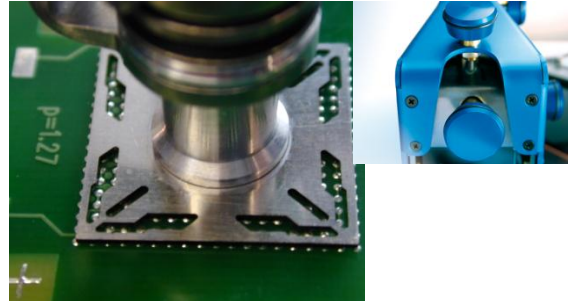

Align stencil to pattern on PCB using manipulators XYZ0 knobs at SHP

Step #3

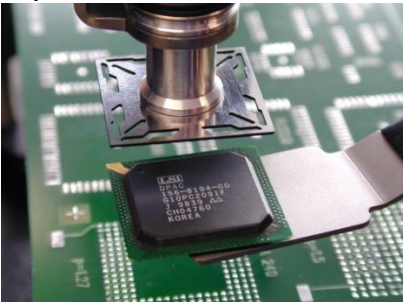

Install BGA to stencil. Vacuum holds the chip in place

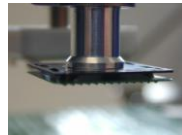

Step #4

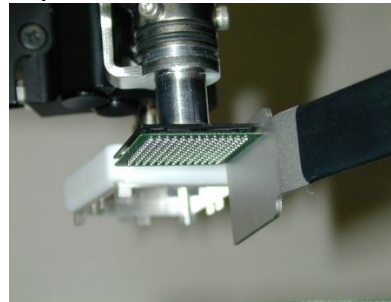

Align BGA to stencil outline

Step #5

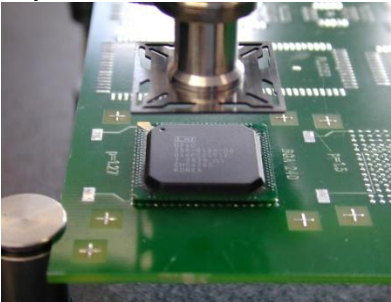















Place BGA on PCB and switch vacuum off.

STAR-TOOLS



STAR TOOLS are available for 7 different BGA sizes and cover almost the whole size spectrum.

TECH INFO – STAR TOOL PLACEMENT

Optional Extras			
LW40.0042	Placement Nozzle Star Tool 10mm for BGA >= 20mm and SHP		1 piece
LW40.0041	Placement Nozzle Star Tool 5mm for BGA >= 15mm and SHP		1 piece
LW39.1999	Star Tool set BGA 7 pieces (15, 23, 27, 31, 35, 37.5, 40)		1 piece
LW39.1916	Star Tool BGA 15*15mm placement tool for ASP/SHP arm		1 piece
LW39.1901	Star Tool BGA 23*23mm placement tool for ASP/SHP arm		1 piece
LW39.1900	Star Tool BGA 27*27mm placement tool for ASP/SHP arm		1 piece
LW39.1906	Star Tool BGA 31*31mm placement tool for ASP/SHP arm		1 piece
LW39.1909	Star Tool BGA 35*35mm placement tool for ASP/SHP arm		1 piece
LW39.1910	Star Tool BGA 37,5*37,5mm placement tool for ASP/SHP arm		1 piece
LW39.1911	Star Tool BGA 40*40mm placement tool for ASP/SHP arm		1 piece
LW39.1912	Star Tool BGA 42.5*42.5mm placement tool for ASP/SHP arm		1 piece
Star Tools are available for many SMD sizes. Please contact MARTIN for more Info.			
HT00.0119	Flux Creme lead free 18g 0506 MA, no clean, RELO, with Brush	 Lead free	1 piece
HT00.0020	Brush for Flux Creme		1 piece
HT00.0019	Clean Pen for pads and IR Glass with 3 spare erasers		1 piece

X-ON Electronics

Largest Supplier of Electrical and Electronic Components

Click to view similar products for [Martin SMT manufacturer](#):

Other Similar products are found below :

[HF00.0018](#) [VD90.5005](#) [HT00.0019](#) [HT00.0119](#) [HT00.0013](#)