

PRODUCT NUMBER
SEE TABLE

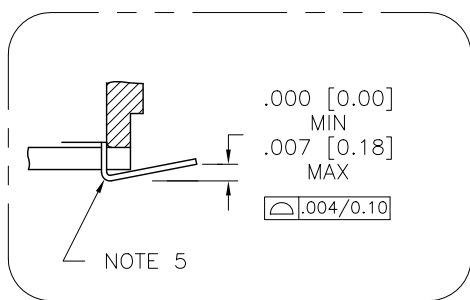
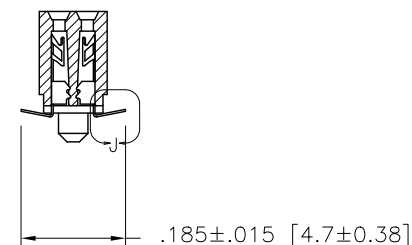
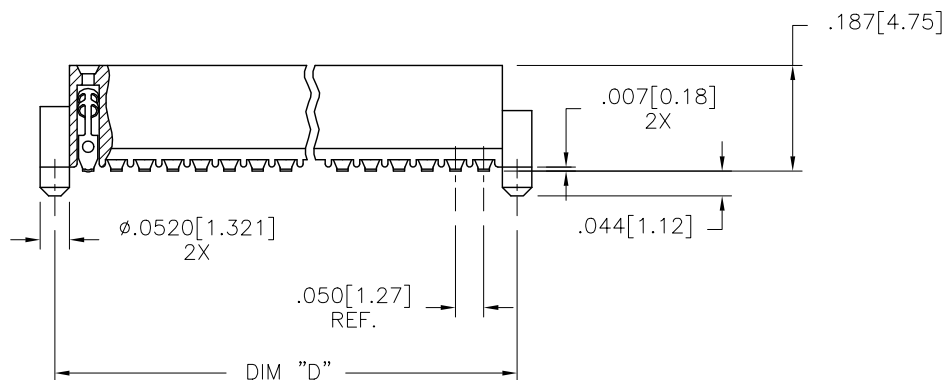
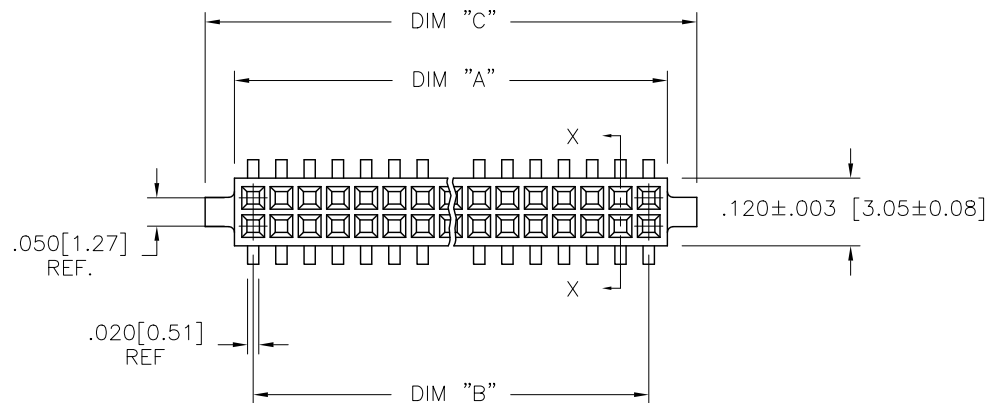

DETAIL J
SCALE 10/1

mat'l. code				surface		tolerance		projection		product family			
-				ISO 1302 ✓		ISO 406 ISO 1101				RIB CAGE			
ltr	ecn no	dr	date	tolerances unless otherwise specified						title			
AC	M05-0084	MHT	5/05/05	angles	linear	xx ±.01/.3		INCH/MM		.050cc VERT. CARD CONN.			
AD	M06-0284	AEA	7/27/06			xxx ±.005/.13				SURF. MT. W/LOC. FEATURES			
AE	M07-0267	MHT	6/08/07	$\sigma \pm 2'$		xxxx ±.0020/.050		scale 3:1		dwg no			
AF	M07-0345	AGS	7/26/07	dr	M. CLOUSER	5/25/91				sheet 1 of 4 size			
AG	M09-0345	CMR	4/06/09	enfr	B. BARUFFALO	5/25/91				87023		A3	
AH	N10-0174	YO	6/17/10	chr	B. BARUFFALO	5/25/91							
AJ	ELX-N-010201	YO	2/8/12	appd	B. BARUFFALO	5/25/91						type Product Customer Drawing	
sheet	revision	AJ	AJ	AJ	AJ								
index	sheet	1	2	3	4								

PRODUCT NO.
87023 - XXX

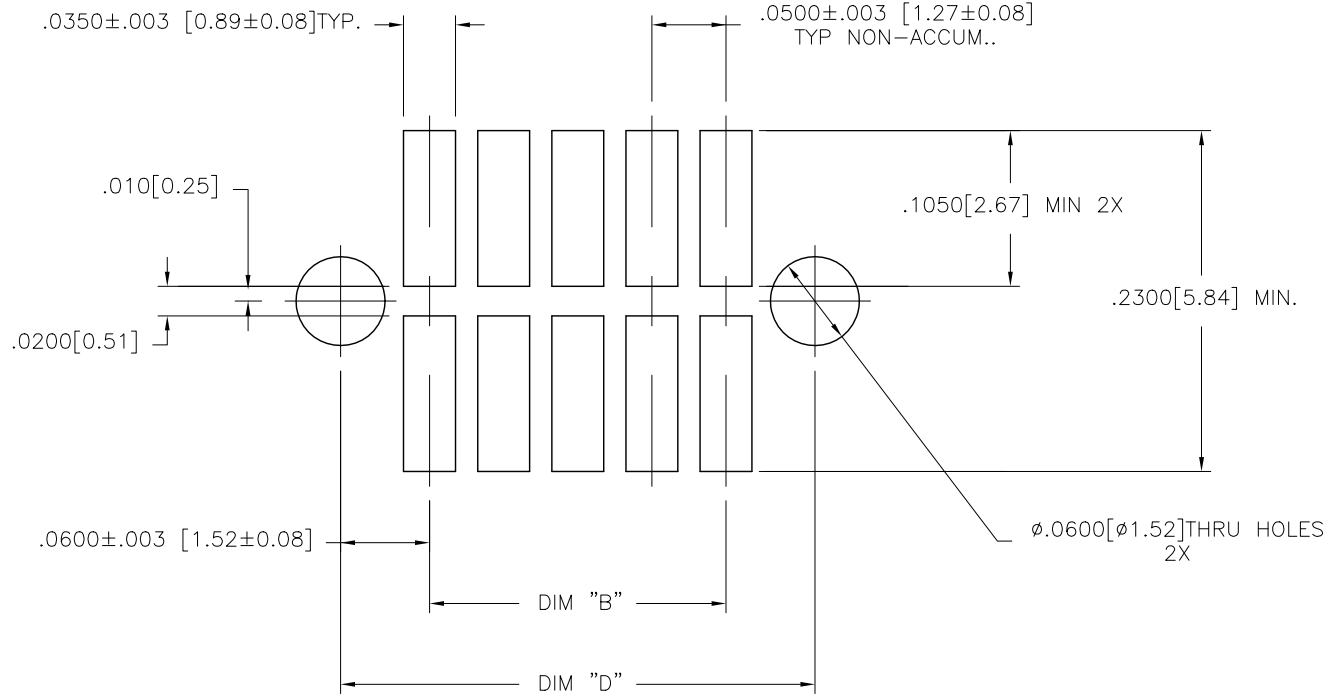
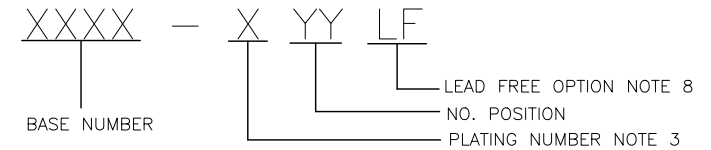

FIGURE A
RECOMMENDED
P.C.B. LAYOUT

mat'l. code -		surface ISO 1302 ✓		tolerance ISO 406 ISO 1101		projection [Symbol]		product family RIB CAGE	
ltr	ecn	no	dr	date		tolerances unless otherwise specified		title	
AJ						angles	linear	XX ±.01/.3	.050cc VERT. CARD CONN. SURF. MT. W/LOC. FEATURES
						σ±2'		xxx ±.005/.13	
								xxxx ±.0020/.050	scale 3:1
						dr	M. CLOUSER	5/25/91	
						enfr	B. BARUFFALO	5/25/91	FCI
						chr	B. BARUFFALO	5/25/91	
						appd	B. BARUFFALO	5/25/91	dwg no 87023
sheet index		revision sheet						sheet 2 of 4 size A3	
								type Product Customer Drawing	

PRODUCT NO. NOTE 8	SIZE	DIM A	DIM B	DIM C	DIM D	SPECIAL PACKAGING	TAPE WIDTH		PIECES PER REEL
								PITCH	
87023-605	2 X 5	.266/6.756	.200/5.08	.370/9.398	.3200/8.128	NOTE 6	24mm	12mm	750
-610	2 X 10	.516/13.106	.450/11.43	.620/15.748	.5700/14.478	NOTE 6	24mm	12mm	750
-615	2 X 15	.766/19.456	.700/17.78	.870/22.098	.8200/20.828	NOTE 6	44mm	12mm	500
-620	2 X 20	1.016/25.806	.950/24.13	1.120/28.448	1.0700/27.178	NOTE 6 & 7	44mm	12mm	500
-625	2 X 25	1.266/32.156	1.200/30.48	1.370/34.798	1.3200/33.528	NOTE 6	56mm	12mm	500
-630	2 X 30	1.516/38.506	1.450/36.83	1.620/41.148	1.5700/39.878	NOTE 6 & 7	56mm	12mm	500
-635	2 X 35	1.766/44.856	1.700/43.18	1.870/47.498	1.8200/46.228	NOTE 6	72mm	12mm	500
-640	2 X 40	2.016/51.206	1.950/49.53	2.120/53.848	2.0700/52.578	NOTE 6 & 7	72mm	12mm	500
-645	2 X 45	2.266/57.556	2.200/55.88	2.370/60.198	2.3200/58.928	NOTE 6	72mm	12mm	500
-650	2 X 50	2.516/63.906	2.450/62.23	2.620/66.548	2.5700/65.278	NOTE 6	88mm	12mm	500
-905	2 X 5	.266/6.756	.200/5.08	.370/9.398	.3200/8.128	NO	—	—	—
-910	2 X 10	.516/13.106	.450/11.43	.620/15.748	.5700/14.478	NO	—	—	—
-915	2 X 15	.766/19.456	.700/17.78	.870/22.098	.8200/20.828	NO	—	—	—
-920	2 X 20	1.016/25.806	.950/24.13	1.120/28.448	1.0700/27.178	NO	—	—	—
-925	2 X 25	1.266/32.156	1.200/30.48	1.370/34.798	1.3200/33.528	NO	—	—	—
-930	2 X 30	1.516/38.506	1.450/36.83	1.620/41.148	1.5700/39.878	NO	—	—	—
-935	2 X 35	1.766/44.856	1.700/43.18	1.870/47.498	1.8200/46.228	NO	—	—	—
-940	2 X 40	2.016/51.206	1.950/49.53	2.120/53.848	2.0700/52.578	NO	—	—	—
-945	2 X 45	2.266/57.556	2.200/55.88	2.370/60.198	2.3200/58.928	NO	—	—	—
87023-950	2 X 50	2.516/63.906	2.450/62.23	2.620/66.548	2.5700/65.278	NO	—	—	—



NOTES:

- ① HOUSING MATERIAL:
GLASS FILLED THERMOPLASTIC FLAME RETARDANT PER UL 94V-0
COLOR: NATURAL
- ② TERMINAL MATERIAL: BeCu
- ③ TERMINAL PLATING:
-6XXLF: 30u"/.76um MIN HARD GOLD OR GXT OVER Ni ON CONTACT ZONES.
100u"/2.54um MIN PURE TIN OVER Ni
IN SOLDERING ZONES, OTHERWISE GOLD FLASH OR UNPLATED.

-9XXLF: 60u"/1.52um MIN HARD GOLD ON CONTACT ZONES,
100u"/2.54um MIN PURE TIN OVER Ni
OVER Ni IN SOLDERING ZONES, OTHERWISE GOLD FLASH OR UNPLATED.
- 4 APPLICATION INFORMATION:
A. RECOMMENDED MOUNTING PAD PATTERN IS SHOWN IN FIGURE "A".

B. MATING PINS TO BE .0176/0.447 TO .0181/0.459 DIA.

C. MATING PIN TIPS TO BE IN TRUE POSITION TO MATING GRID WITHIN .006/0.15 DIA.

D. SUGGESTED MATING PIN LENGTH .130/3.30 ±.010/0.25.
- ⑤ LEAD TIPS TO BE ABOVE HEEL, UP TO .007/0.18 MAX.
COPLANARITY TO BE MEASURED AT LOWEST POINT (HEEL).
- ⑥ ADD "TR" TO END OF DASH NUMBER FOR TAPE AND REEL PACKAGED WITH CAP. TOOLED ONLY FOR NOTED CONNECTORS.
7. ADD "CT" TO END OF DASH NUMBER FOR CONNECTOR WITH CAP FOR VACUUM PICKUP IN TUBE.
- ⑧ ADD LF SUFFIX AT THE END OF PART NUMBER FOR LEAD FREE OPTION.
9. THE HOUSING WILL WITHSTAND EXPOSURE TO 260°C PEAK TEMPERATURE FOR 20 SECONDS IN A CONVECTION, INFRA-RED OR VAPOR PHASE REFLOW OVEN. SEE APPLICATION NOTE/PROCEDURES IF THEY ARE AVAILABLE.
- ⑩ THIS PRODUCT MEETS EUROPEAN UNION DIRECTIVES AND OTHER COUNTRY REGULATION AS DESCRIBED IN GS-22-008.
11. PRODUCT SPEC PER BUS-12-087.

mat'l. code		surface		tolerance		projection		product family	
-		ISO 1302 ✓		ISO 406				RIB CAGE	
				ISO 1101				title	
ltr		ecn		no		dr		date	
AJ									
				tolerances unless otherwise specified				.050cc VERT. CARD CONN.	
				angles		linear		SURF. MT. W/LOC. FEATURES	
				σ±2'		xxx ±.005/.13		scale 3:1	
				dr		M. CLOUSER 5/25/91		dwg no	
				enrg		B. BARUFFALO 5/25/91		sheet 3 of 4	
				chr		B. BARUFFALO 5/25/91		size	
				appd		B. BARUFFALO 5/25/91		87023	
								A3	
								type Product Customer Drawing	
sheet		revision							
index		sheet							

PRODUCT NUMBER
SEE TABLE

UNREELING
DIRECTION

REFERENCE ONLY

TAPE WIDTH'S 32mm AND ABOVE HAS BOTH FEED TRACKS,
BELOW 32mm HAS TOP FEED TRACK ONLY.

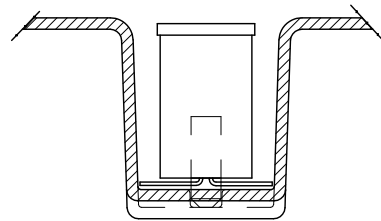
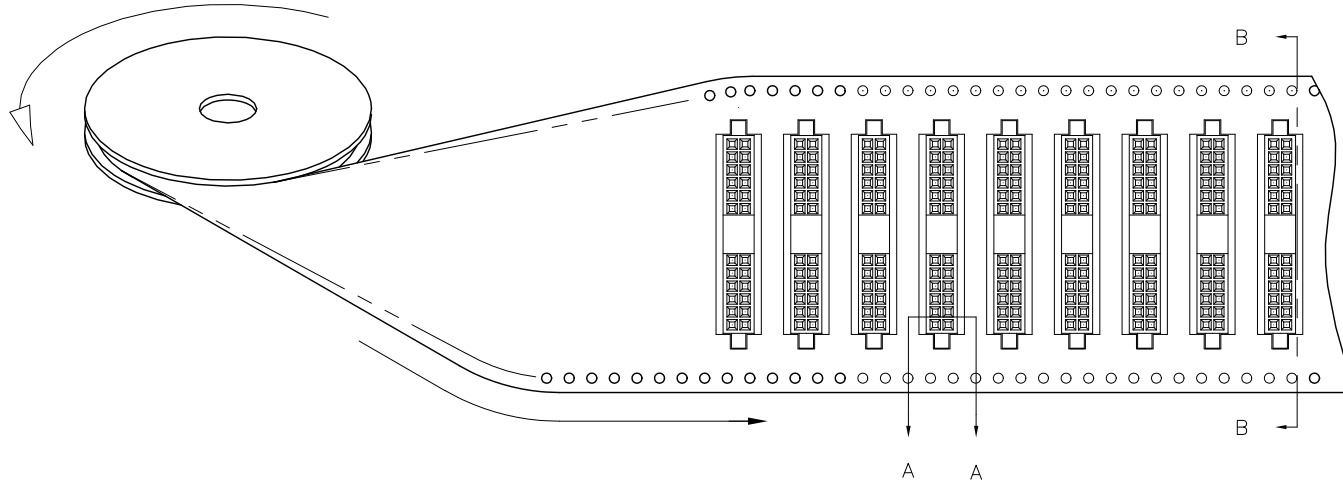

SECTION A-A

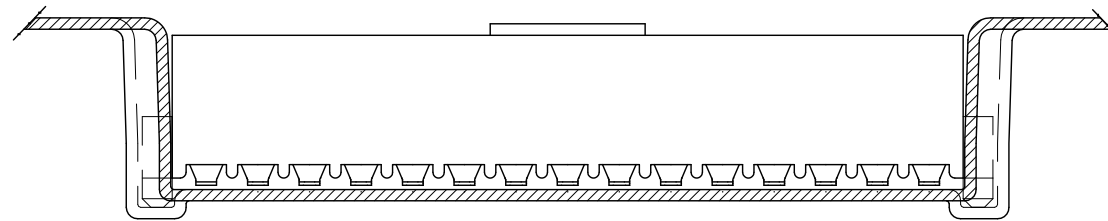

SECTION B-B

mat'l. code		surface		tolerance		projection		product family	
-		ISO 1302 ✓		ISO 406 ISO 1101				RIB CAGE	
ltr	ecn	no	dr	date		tolerances unless otherwise specified		title	
AJ						angles linear xx ±.01/.3 xxx ±.005/.13 xxx ±.0020/.050		.050cc VERT. CARD CONN. SURF. MT. W/LOC. FEATURES	
				dr		M. CLOUSER 5/25/91		dwg no	
				enrg		B. BARUFFALO 5/25/91		sheet 4 of 4 size	
				chr		B. BARUFFALO 5/25/91		87023 A3	
				appd		B. BARUFFALO 5/25/91		type Product Customer Drawing	
sheet index		revision sheet							



X-ON Electronics

Largest Supplier of Electrical and Electronic Components

Click to view similar products for [Headers & Wire Housings](#) category:

Click to view products by [FCT Electronics](#) manufacturer:

Other Similar products are found below :

[95000-104TRLF](#) [10135584-644402LF](#) [DF62W-EP2022PCA](#) [95000-106TRLF](#) [DF62W-2022SCA](#) [DF62W-EP2022PC](#) [2203348](#) [DF62W-2022SC](#) [1084018](#) [1029039](#) [1084017](#) [802-10-012-10-002000](#) [1112640](#) [1112639](#) [891-007-9SS-BST1T](#) [000-34000](#) [0008550134](#) [0009482033](#) [0009507031](#) [57102-F02-18ULF](#) [57102-S06-03LF](#) [57202-S52-04LF](#) [PCN6-15S-2.5E](#) [0039019024](#) [58102-G61-06LF](#) [582553-1](#) [0009485154](#) [0009508121](#) [0022285053](#) [0050291907](#) [018731A](#) [LY20-4P-DT1-P1E-BR](#) [02.125.8002.8](#) [60101931](#) [60598-1 \(Cut Strip\)](#) [M1625-3R/100](#) [61062-3](#) [61082-181009](#) [CSU011177004](#) [636-1427](#) [638009-1](#) [641938-9](#) [641991-4](#) [644168-1](#) [644827-2](#) [647662-1](#) [65039-019ELF](#) [65692-001LF](#) [65781-018](#) [65781-047](#)