

## Miniature Single-Cell, Fully Integrated Li-Ion, Li-Polymer Charge Management Controllers

### Features

- Linear Charge Management Controller:
  - Integrated Pass Transistor
  - Integrated Current Sense
  - Reverse Discharge Protection
- High Accuracy Preset Voltage Regulation:  $\pm 0.75\%$
- Four Voltage Regulation Options:
  - 4.20V, 4.35V, 4.40V, 4.50V
- Programmable Charge Current: 15 mA to 500 mA
- Selectable Preconditioning:
  - 10%, 20%, 40%, or Disable
- Selectable End-of-Charge Control:
  - 5%, 7.5%, 10%, or 20%
- Charge Status Output
  - Tri-State Output - MCP73831
  - Open-Drain Output - MCP73832
- Automatic Power-Down
- Thermal Regulation
- Temperature Range:  $-40^{\circ}\text{C}$  to  $+85^{\circ}\text{C}$
- Packaging:
  - 8-Lead, 2 mm x 3 mm DFN
  - 5-Lead, SOT-23

### Applications

- Lithium-Ion/Lithium-Polymer Battery Chargers
- Personal Data Assistants
- Cellular Telephones
- Digital Cameras
- MP3 Players
- Bluetooth Headsets
- USB Chargers

### Typical Application



### Description:

The MCP73831/2 devices are highly advanced linear charge management controllers for use in space-limited, cost-sensitive applications. The MCP73831/2 are available in an 8-Lead, 2 mm x 3 mm DFN package or a 5-Lead, SOT-23 package. Along with their small physical size, the low number of external components required make the MCP73831/2 ideally suited for portable applications. For applications charging from a USB port, the MCP73831/2 adhere to all the specifications governing the USB power bus.

The MCP73831/2 employ a constant-current/constant-voltage charge algorithm with selectable preconditioning and charge termination. The constant voltage regulation is fixed with four available options: 4.20V, 4.35V, 4.40V or 4.50V, to accommodate new, emerging battery charging requirements. The constant current value is set with one external resistor. The MCP73831/2 devices limit the charge current based on die temperature during high power or high ambient conditions. This thermal regulation optimizes the charge cycle time while maintaining device reliability.

Several options are available for the preconditioning threshold, preconditioning current value, charge termination value and automatic recharge threshold. The preconditioning value and charge termination value are set as a ratio, or percentage, of the programmed constant current value. Preconditioning can be disabled. Refer to **Section 1.0 “Electrical Characteristics”** for available options and the **“Product Identification System”** for standard options.

The MCP73831/2 devices are fully specified over the ambient temperature range of  $-40^{\circ}\text{C}$  to  $+85^{\circ}\text{C}$ .

### Package Types



# MCP73831/2

## Functional Block Diagram



## 1.0 ELECTRICAL CHARACTERISTICS

### Absolute Maximum Ratings†

$V_{DD}$  ..... 7.0V  
 All Inputs and Outputs w.r.t.  $V_{SS}$  ..... -0.3 to ( $V_{DD}+0.3$ )V  
 Maximum Junction Temperature,  $T_J$  ..... Internally Limited  
 Storage temperature ..... -65°C to +150°C  
 ESD protection on all pins:  
 Human Body Model (1.5 k $\Omega$  in Series with 100 pF) .....  $\geq 4$  kV  
 Machine Model (200 pF, No Series Resistance) ..... 400V

† **Notice:** Stresses above those listed under “Maximum Ratings” may cause permanent damage to the device. This is a stress rating only and functional operation of the device at those or any other conditions above those indicated in the operational listings of this specification is not implied. Exposure to maximum rating conditions for extended periods may affect device reliability.

### DC CHARACTERISTICS

**Electrical Specifications:** Unless otherwise indicated, all limits apply for  $V_{DD} = [V_{REG}(\text{typical}) + 0.3V]$  to 6V,  $T_A = -40^\circ\text{C}$  to  $+85^\circ\text{C}$ . Typical values are at  $+25^\circ\text{C}$ ,  $V_{DD} = [V_{REG}(\text{typical}) + 1.0V]$

Parameters	Sym.	Min.	Typ.	Max.	Units	Conditions
<b>Supply Input</b>						
Supply Voltage	$V_{DD}$	3.75	—	6	V	
Supply Current	$I_{SS}$	—	510	1500	$\mu\text{A}$	Charging
		—	53	200	$\mu\text{A}$	Charge Complete, No Battery
		—	25	50	$\mu\text{A}$	PROG Floating
		—	1	5	$\mu\text{A}$	$V_{DD} \leq (V_{BAT} - 50 \text{ mV})$
		—	0.1	2	$\mu\text{A}$	$V_{DD} < V_{STOP}$
UVLO Start Threshold	$V_{START}$	3.3	3.45	3.6	V	$V_{DD}$ Low-to-High
UVLO Stop Threshold	$V_{STOP}$	3.2	3.38	3.5	V	$V_{DD}$ High-to-Low
UVLO Hysteresis	$V_{HYS}$	—	70	—	mV	
<b>Voltage Regulation (Constant-Voltage Mode)</b>						
Regulated Output Voltage	$V_{REG}$	4.168	4.20	4.232	V	MCP7383X-2
		4.317	4.35	4.383	V	MCP7383X-3
		4.367	4.40	4.433	V	MCP7383X-4
		4.466	4.50	4.534	V	MCP7383X-5
Line Regulation	$ \frac{\Delta V_{BAT}}{V_{BAT}} / \frac{\Delta V_{DD}}{V_{DD}} $	—	0.09	0.30	%/V	$V_{DD} = [V_{REG}(\text{typical})+1V]$ to 6V, $I_{OUT} = 10 \text{ mA}$
Load Regulation	$ \frac{\Delta V_{BAT}}{V_{BAT}} $	—	0.05	0.30	%	$I_{OUT} = 10 \text{ mA}$ to 50 mA $V_{DD} = [V_{REG}(\text{typical})+1V]$
Supply Ripple Attenuation	PSRR	—	52	—	dB	$I_{OUT}=10 \text{ mA}$ , 10Hz to 1 kHz
		—	47	—	dB	$I_{OUT}=10 \text{ mA}$ , 10Hz to 10 kHz
		—	22	—	dB	$I_{OUT}=10 \text{ mA}$ , 10Hz to 1 MHz
<b>Current Regulation (Fast Charge Constant-Current Mode)</b>						
Fast Charge Current Regulation	$I_{REG}$	90	100	110	mA	PROG = 10 k $\Omega$
		450	505	550	mA	PROG = 2.0 k $\Omega$ , <b>Note 1</b>
		12.5	14.5	16.5	mA	PROG = 67 k $\Omega$

**Note 1:** Not production tested. Ensured by design.

# MCP73831/2

## DC CHARACTERISTICS (CONTINUED)

<b>Electrical Specifications:</b> Unless otherwise indicated, all limits apply for $V_{DD} = [V_{REG}(\text{typical}) + 0.3V]$ to 6V, $T_A = -40^\circ\text{C}$ to $+85^\circ\text{C}$ . Typical values are at $+25^\circ\text{C}$ , $V_{DD} = [V_{REG}(\text{typical}) + 1.0V]$						
Parameters	Sym.	Min.	Typ.	Max.	Units	Conditions
<b>Preconditioning Current Regulation (Trickle Charge Constant-Current Mode)</b>						
Precondition Current Ratio	$I_{PREG} / I_{REG}$	7.5	10	12.5	%	PROG = 2.0 k $\Omega$ to 10 k $\Omega$
		15	20	25	%	PROG = 2.0 k $\Omega$ to 10 k $\Omega$
		30	40	50	%	PROG = 2.0 k $\Omega$ to 10 k $\Omega$
		—	100	—	%	No Preconditioning
						$T_A = -5^\circ\text{C}$ to $+55^\circ\text{C}$
Precondition Voltage Threshold Ratio	$V_{PTH} / V_{REG}$	64	66.5	69	%	$V_{BAT}$ Low-to-High
		69	71.5	74	%	$V_{BAT}$ Low-to-High
Precondition Hysteresis	$V_{PHYS}$	—	110	—	mV	$V_{BAT}$ High-to-Low
<b>Charge Termination</b>						
Charge Termination Current Ratio	$I_{TERM} / I_{REG}$	3.75	5	6.25	%	PROG = 2.0 k $\Omega$ to 10 k $\Omega$
		5.6	7.5	9.4	%	PROG = 2.0 k $\Omega$ to 10 k $\Omega$
		8.5	10	11.5	%	PROG = 2.0 k $\Omega$ to 10 k $\Omega$
		15	20	25	%	PROG = 2.0 k $\Omega$ to 10 k $\Omega$
<b>Automatic Recharge</b>						
Recharge Voltage Threshold Ratio	$V_{RTH} / V_{REG}$	91.5	94.0	96.5	%	$V_{BAT}$ High-to-Low
		94	96.5	99	%	$V_{BAT}$ High-to-Low
<b>Pass Transistor ON-Resistance</b>						
ON-Resistance	$R_{DSON}$	—	350	—	m $\Omega$	$V_{DD} = 3.75V$ , $T_J = 105^\circ\text{C}$
<b>Battery Discharge Current</b>						
Output Reverse Leakage Current	$I_{DISCHARGE}$	—	0.15	2	$\mu\text{A}$	PROG Floating
		—	0.25	2	$\mu\text{A}$	$V_{DD}$ Floating
		—	0.15	2	$\mu\text{A}$	$V_{DD} < V_{STOP}$
		—	-5.5	-15	$\mu\text{A}$	Charge Complete
<b>Status Indicator – STAT</b>						
Sink Current	$I_{SINK}$	—	—	25	mA	
Low Output Voltage	$V_{OL}$	—	0.4	1	V	$I_{SINK} = 4$ mA
Source Current	$I_{SOURCE}$	—	—	35	mA	
High Output Voltage	$V_{OH}$	—	$V_{DD}-0.4$	$V_{DD} - 1$	V	$I_{SOURCE} = 4$ mA (MCP73831)
Input Leakage Current	$I_{LK}$	—	0.03	1	$\mu\text{A}$	High-Impedance
<b>PROG Input</b>						
Charge Impedance Range	$R_{PROG}$	2	—	67	k $\Omega$	
Minimum Shutdown Impedance	$R_{PROG}$	70	—	200	k $\Omega$	
<b>Automatic Power Down</b>						
Automatic Power Down Entry Threshold	$V_{PDENTER}$	$V_{DD} < (V_{BAT} + 20 \text{ mV})$	$V_{DD} < (V_{BAT} + 50 \text{ mV})$	—		$3.5V \leq V_{BAT} \leq V_{REG}$ $V_{DD}$ Falling
Automatic Power Down Exit Threshold	$V_{PDEXIT}$	—	$V_{DD} < (V_{BAT} + 150 \text{ mV})$	$V_{DD} < (V_{BAT} + 200 \text{ mV})$		$3.5V \leq V_{BAT} \leq V_{REG}$ $V_{DD}$ Rising
<b>Thermal Shutdown</b>						
Die Temperature	$T_{SD}$	—	150	—	$^\circ\text{C}$	
Die Temperature Hysteresis	$T_{SDHYS}$	—	10	—	$^\circ\text{C}$	

**Note 1:** Not production tested. Ensured by design.

## AC CHARACTERISTICS

**Electrical Specifications:** Unless otherwise indicated, all limits apply for  $V_{DD} = [V_{REG} (\text{typical}) + 0.3V]$  to 12V,  $T_A = -40^\circ\text{C}$  to  $+85^\circ\text{C}$ . Typical values are at  $+25^\circ\text{C}$ ,  $V_{DD} = [V_{REG} (\text{typical}) + 1.0V]$

Parameters	Sym.	Min.	Typ.	Max.	Units	Conditions
UVLO Start Delay	$t_{START}$	—	—	5	ms	$V_{DD}$ Low-to-High
<b>Constant-Current Regulation</b>						
Transition Time Out of Preconditioning	$t_{DELAY}$	—	—	1	ms	$V_{BAT} < V_{PTH}$ to $V_{BAT} > V_{PTH}$
Current Rise Time Out of Preconditioning	$t_{RISE}$	—	—	1	ms	$I_{OUT}$ Rising to 90% of $I_{REG}$
Termination Comparator Filter	$t_{TERM}$	0.4	1.3	3.2	ms	Average $I_{OUT}$ Falling
Charge Comparator Filter	$t_{CHARGE}$	0.4	1.3	3.2	ms	Average $V_{BAT}$
<b>Status Indicator</b>						
Status Output turn-off	$t_{OFF}$	—	—	200	$\mu\text{s}$	$I_{SINK} = 1 \text{ mA}$ to $0 \text{ mA}$
Status Output turn-on	$t_{ON}$	—	—	200	$\mu\text{s}$	$I_{SINK} = 0 \text{ mA}$ to $1 \text{ mA}$

## TEMPERATURE SPECIFICATIONS

**Electrical Specifications:** Unless otherwise indicated, all limits apply for  $V_{DD} = [V_{REG} (\text{typical}) + 0.3V]$  to 12V. Typical values are at  $+25^\circ\text{C}$ ,  $V_{DD} = [V_{REG} (\text{typical}) + 1.0V]$

Parameters	Sym.	Min.	Typ.	Max.	Units	Conditions
<b>Temperature Ranges</b>						
Specified Temperature Range	$T_A$	-40	—	+85	$^\circ\text{C}$	
Operating Temperature Range	$T_J$	-40	—	+125	$^\circ\text{C}$	
Storage Temperature Range	$T_A$	-65	—	+150	$^\circ\text{C}$	
<b>Thermal Package Resistances</b>						
5-Lead, SOT-23	$\theta_{JA}$	—	230	—	$^\circ\text{C/W}$	4-Layer JC51-7 Standard Board, Natural Convection ( <b>Note 2</b> )
8-Lead, 2 mm x 3 mm, DFN	$\theta_{JA}$	—	76	—	$^\circ\text{C/W}$	4-Layer JC51-7 Standard Board, Natural Convection ( <b>Note 1</b> )

**Note 1:** This represents the minimum copper condition on the PCB (Printed Circuit Board).

**2:** With large copper area on the PCB, the SOT-23-5 thermal resistance ( $\theta_{JA}$ ) can reach a typical value of  $130^\circ\text{C/W}$  or better.

# MCP73831/2

---

NOTES:

## 2.0 TYPICAL PERFORMANCE CURVES

**Note:** The graphs and tables provided following this note are a statistical summary based on a limited number of samples and are provided for informational purposes only. The performance characteristics listed herein are not tested or guaranteed. In some graphs or tables, the data presented may be outside the specified operating range (e.g., outside specified power supply range) and therefore outside the warranted range.

**Note:** Unless otherwise indicated,  $V_{DD} = [V_{REG}(\text{typical}) + 1V]$ ,  $I_{OUT} = 10 \text{ mA}$  and  $T_A = +25^\circ\text{C}$ , Constant-Voltage mode.

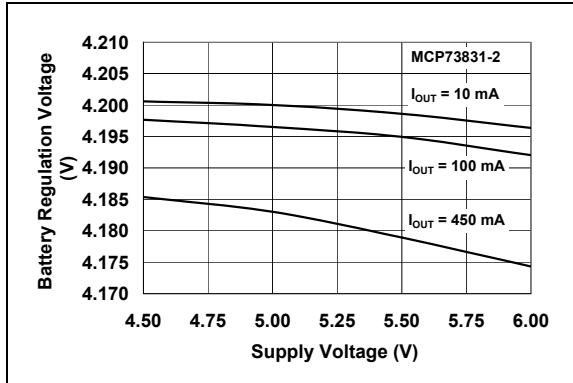

**FIGURE 2-1:** Battery Regulation Voltage ( $V_{BAT}$ ) vs. Supply Voltage ( $V_{DD}$ ).

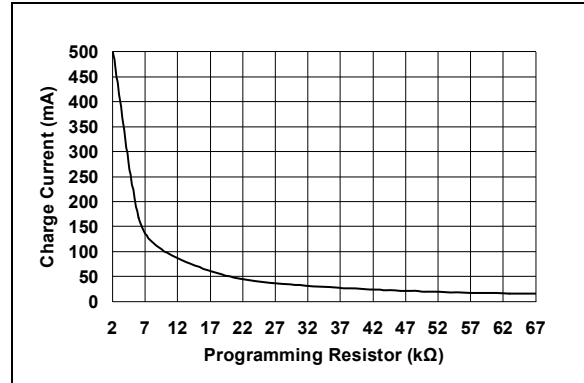

**FIGURE 2-4:** Charge Current ( $I_{OUT}$ ) vs. Programming Resistor ( $R_{PROG}$ ).

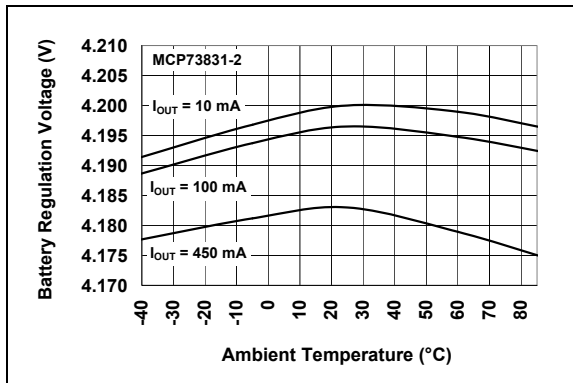

**FIGURE 2-2:** Battery Regulation Voltage ( $V_{BAT}$ ) vs. Ambient Temperature ( $T_A$ ).

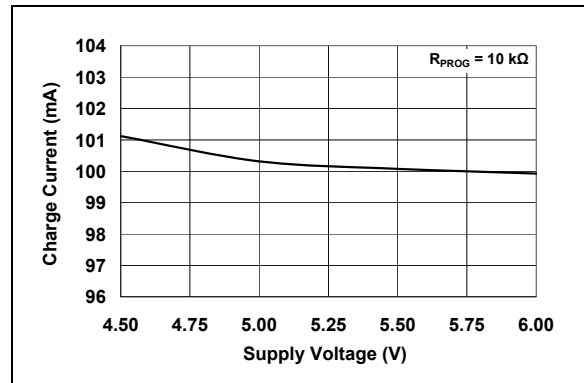

**FIGURE 2-5:** Charge Current ( $I_{OUT}$ ) vs. Supply Voltage ( $V_{DD}$ ).

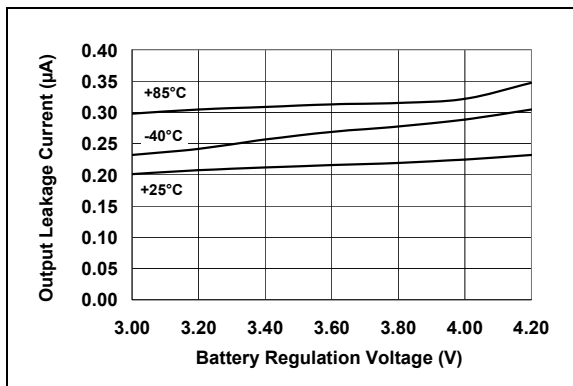

**FIGURE 2-3:** Output Leakage Current ( $I_{DISCHARGE}$ ) vs. Battery Regulation Voltage ( $V_{BAT}$ ).

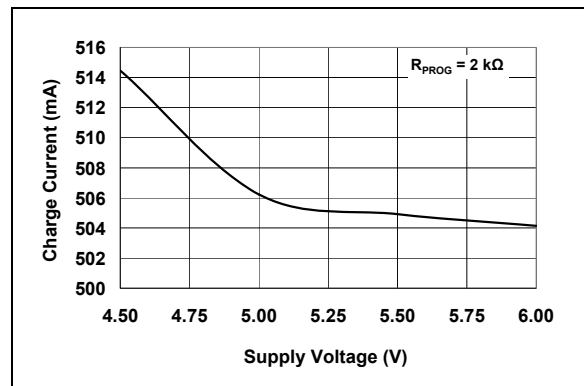
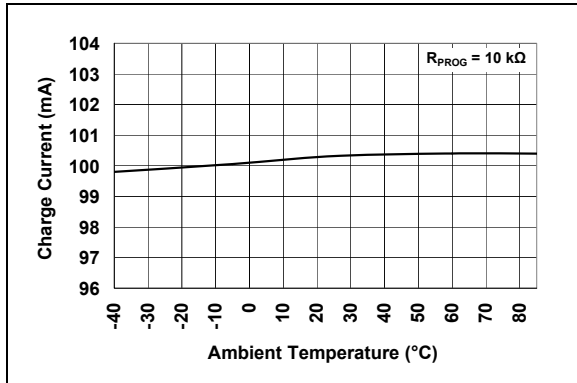

**FIGURE 2-6:** Charge Current ( $I_{OUT}$ ) vs. Supply Voltage ( $V_{DD}$ ).

# MCP73831/2

## TYPICAL PERFORMANCE CURVES (CONTINUED)

Note: Unless otherwise indicated,  $V_{DD} = [V_{REG}(\text{typical}) + 1V]$ ,  $I_{OUT} = 10 \text{ mA}$  and  $T_A = +25^\circ\text{C}$ , Constant-Voltage mode.



**FIGURE 2-7:** Charge Current ( $I_{OUT}$ ) vs. Ambient Temperature ( $T_A$ ).

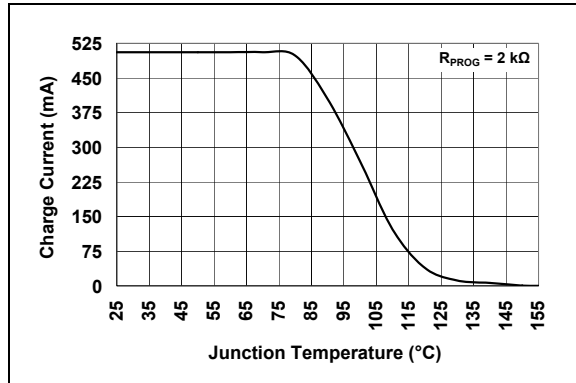

**FIGURE 2-10:** Charge Current ( $I_{OUT}$ ) vs. Junction Temperature ( $T_J$ ).

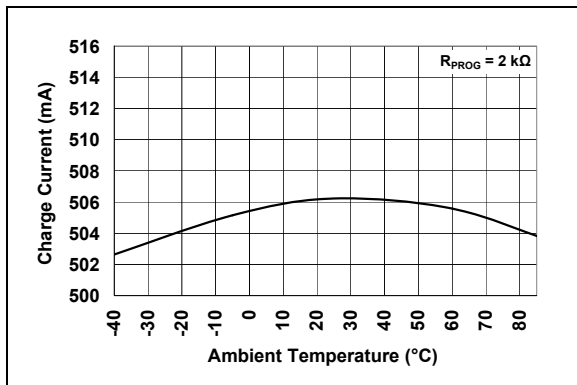

**FIGURE 2-8:** Charge Current ( $I_{OUT}$ ) vs. Ambient Temperature ( $T_A$ ).

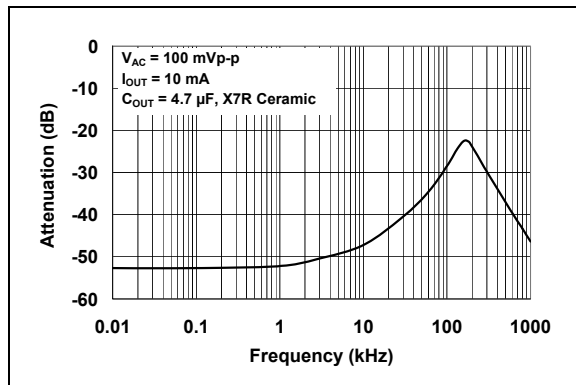

**FIGURE 2-11:** Power Supply Ripple Rejection (PSRR).

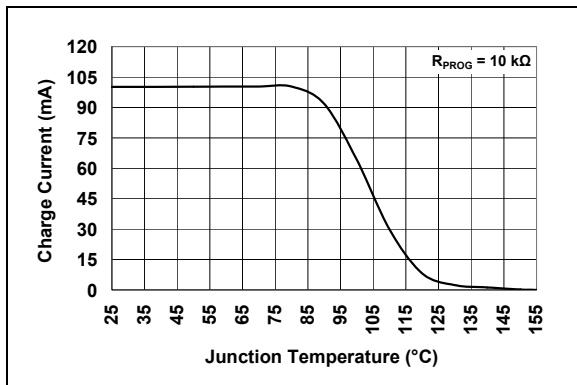

**FIGURE 2-9:** Charge Current ( $I_{OUT}$ ) vs. Junction Temperature ( $T_J$ ).

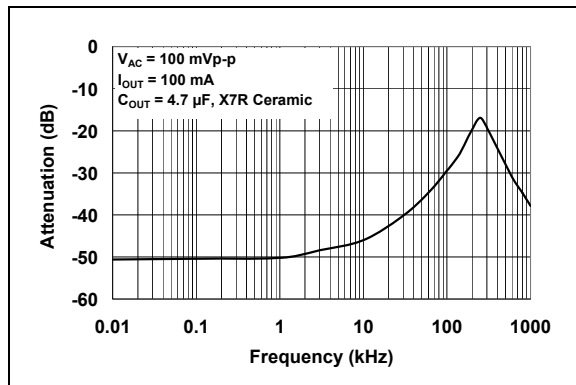

**FIGURE 2-12:** Power Supply Ripple Rejection (PSRR).



## TYPICAL PERFORMANCE CURVES (CONTINUED)

Note: Unless otherwise indicated,  $V_{DD} = [V_{REG}(\text{typical}) + 1V]$ ,  $I_{OUT} = 10 \text{ mA}$  and  $T_A = +25^\circ\text{C}$ , Constant-Voltage mode.

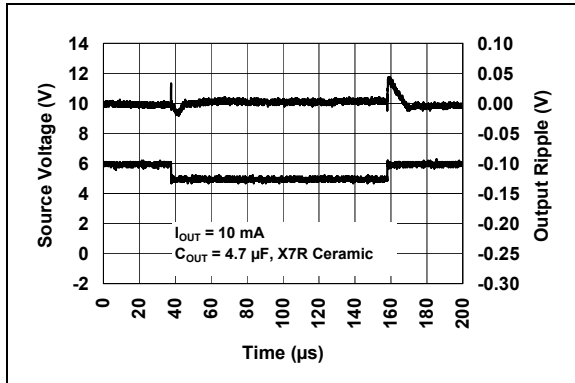

FIGURE 2-13: Line Transient Response.



FIGURE 2-16: Load Transient Response.

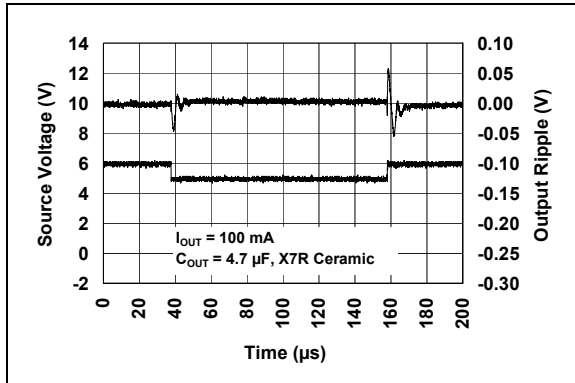

FIGURE 2-14: Line Transient Response.

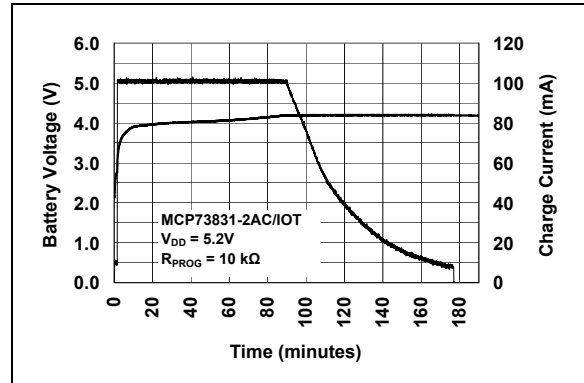

FIGURE 2-17: Complete Charge Cycle (180 mAh Li-Ion Battery).

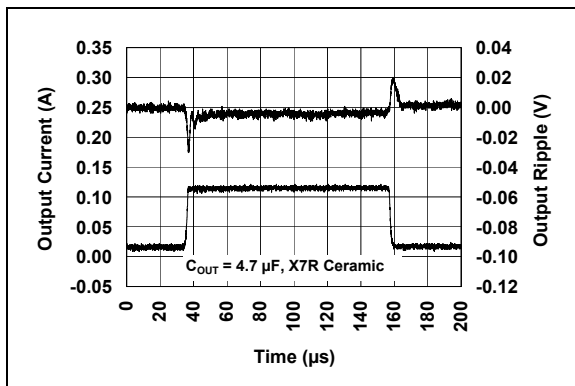

FIGURE 2-15: Load Transient Response.

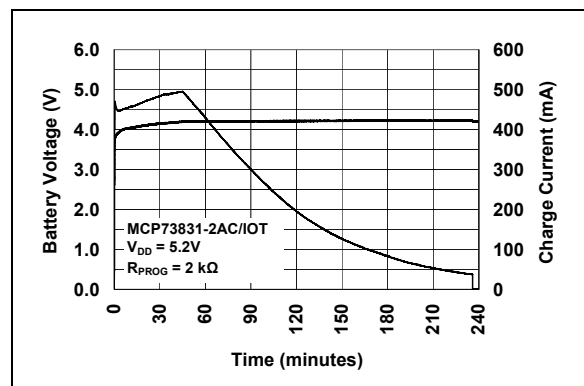

FIGURE 2-18: Complete Charge Cycle (1000 mAh Li-Ion Battery).

# MCP73831/2

---

NOTES:

## 3.0 PIN DESCRIPTION

The descriptions of the pins are listed in [Table 3-1](#).

**TABLE 3-1: PIN FUNCTION TABLES**

Pin No.		Symbol	Function
DFN	SOT-23-5		
1	4	$V_{DD}$	Battery Management Input Supply
2	—	$V_{DD}$	Battery Management Input Supply
3	3	$V_{BAT}$	Battery Charge Control Output
4	—	$V_{BAT}$	Battery Charge Control Output
5	1	STAT	Charge Status Output
6	2	$V_{SS}$	Battery Management 0V Reference
7	—	NC	No Connection
8	5	PROG	Current Regulation Set and Charge Control Enable
9	—	EP	Exposed Thermal Pad (EP); must be connected to $V_{SS}$ .

### 3.1 Battery Management Input Supply ( $V_{DD}$ )

A supply voltage of [ $V_{REG}$  (typical) + 0.3V] to 6V is recommended. Bypass to  $V_{SS}$  with a minimum of 4.7  $\mu$ F.

### 3.2 Battery Charge Control Output ( $V_{BAT}$ )

Connect to positive terminal of battery. Drain terminal of internal P-channel MOSFET pass transistor. Bypass to  $V_{SS}$  with a minimum of 4.7  $\mu$ F to ensure loop stability when the battery is disconnected.

### 3.3 Charge Status Output (STAT)

STAT is an output for connection to an LED for charge status indication. Alternatively, a pull-up resistor can be applied for interfacing to a host microcontroller.

STAT is a tri-state logic output on the MCP73831 and an open-drain output on the MCP73832.

### 3.4 Battery Management 0V Reference ( $V_{SS}$ )

Connect to negative terminal of battery and input supply.

### 3.5 Current Regulation Set (PROG)

Preconditioning, fast charge and termination currents are scaled by placing a resistor from PROG to  $V_{SS}$ .

The charge management controller can be disabled by allowing the PROG input to float.

### 3.6 Exposed Thermal Pad (EP)

There is an internal electrical connection between the Exposed Thermal Pad (EP) and the  $V_{SS}$  pin; they must be connected to the same potential on the Printed Circuit Board (PCB).

Vias are recommended to add from land area of EP to a copper layer on the other side of the PCB for better thermal performance.

# MCP73831/2

---

NOTES:

## 4.0 DEVICE OVERVIEW

The MCP73831/2 are highly advanced linear charge management controllers. [Figure 4-1](#) depicts the operational flow algorithm from charge initiation to completion and automatic recharge.

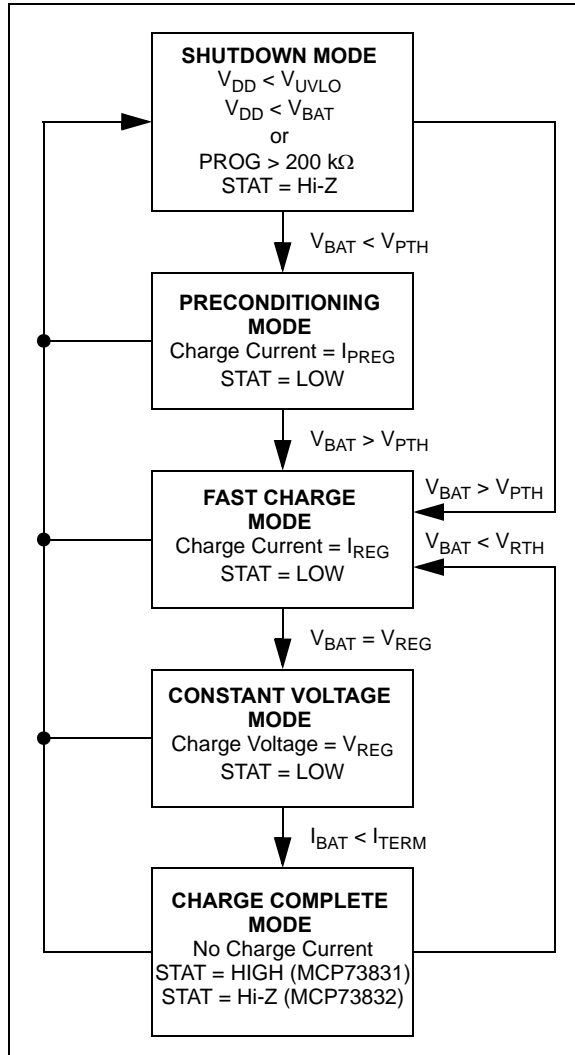

**FIGURE 4-1:** Flowchart.

### 4.1 Undervoltage Lockout (UVLO)

An internal UVLO circuit monitors the input voltage and keeps the charger in Shutdown mode until the input supply rises above the UVLO threshold. The UVLO circuitry has a built in hysteresis of 100 mV.

In the event a battery is present when the input power is applied, the input supply must rise 150 mV above the battery voltage before the MCP73831/2 becomes operational.

The UVLO circuit places the device in Shutdown mode if the input supply falls to within +50 mV of the battery voltage. Again, the input supply must rise to a level 150 mV above the battery voltage before the MCP73831/2 become operational.

The UVLO circuit is always active. Whenever the input supply is below the UVLO threshold or within +50 mV of the voltage at the  $V_{BAT}$  pin, the MCP73831/2 are placed in a Shutdown mode.

During any UVLO condition, the battery reverse discharge current will be less than 2  $\mu$ A.

### 4.2 Charge Qualification

For a charge cycle to begin, all UVLO conditions must be met and a battery or output load must be present. A charge current programming resistor must be connected from PROG to  $V_{SS}$ . If the PROG pin is open or floating, the MCP73831/2 are disabled and the battery reverse discharge current is less than 2  $\mu$ A. In this manner, the PROG pin acts as a charge enable and can be used as a manual shutdown.

### 4.3 Preconditioning

If the voltage at the  $V_{BAT}$  pin is less than the preconditioning threshold, the MCP73831/2 enter a preconditioning or Trickle Charge mode. The preconditioning threshold is factory set. Refer to **Section 1.0 "Electrical Characteristics"** for preconditioning threshold options and the Product Identification System for standard options.

In this mode, the MCP73831/2 supply a percentage of the charge current (established with the value of the resistor connected to the PROG pin) to the battery. The percentage or ratio of the current is factory set. Refer to **Section 1.0 "Electrical Characteristics"** for preconditioning current options and the "Product Identification System" for standard options.

When the voltage at the  $V_{BAT}$  pin rises above the preconditioning threshold, the MCP73831/2 enter the Constant-Current or Fast Charge mode.

### 4.4 Fast Charge Constant-Current Mode

During the Constant-Current mode, the programmed charge current is supplied to the battery or load. The charge current is established using a single resistor from PROG to  $V_{SS}$ . Constant-Current mode is maintained until the voltage at the  $V_{BAT}$  pin reaches the regulation voltage,  $V_{REG}$ .

# MCP73831/2

## 4.5 Constant-Voltage Mode

When the voltage at the  $V_{BAT}$  pin reaches the regulation voltage,  $V_{REG}$ , constant voltage regulation begins. The regulation voltage is factory set to 4.2V, 4.35V, 4.40V, or 4.50V with a tolerance of  $\pm 0.75\%$ .

## 4.6 Charge Termination

The charge cycle is terminated when, during Constant-Voltage mode, the average charge current diminishes below a percentage of the programmed charge current (established with the value of the resistor connected to the PROG pin). A 1 ms filter time on the termination comparator ensures that transient load conditions do not result in premature charge cycle termination. The percentage or ratio of the current is factory set. Refer to **Section 1.0 “Electrical Characteristics”** for charge termination current options and the **”Product Identification System”** for standard options.

The charge current is latched off and the MCP73831/2 enter a Charge Complete mode.

## 4.7 Automatic Recharge

The MCP73831/2 continuously monitor the voltage at the  $V_{BAT}$  pin in the Charge Complete mode. If the voltage drops below the recharge threshold, another charge cycle begins and current is once again supplied to the battery or load. The recharge threshold is factory set. Refer to **Section 1.0 “Electrical Characteristics”** for recharge threshold options and the **”Product Identification System”** for standard options.

## 4.8 Thermal Regulation

The MCP73831/2 limit the charge current based on the die temperature. The thermal regulation optimizes the charge cycle time while maintaining device reliability. [Figure 4-2](#) depicts the thermal regulation for the MCP73831/2.



**FIGURE 4-2:** Thermal Regulation.

## 4.9 Thermal Shutdown

The MCP73831/2 suspend charge if the die temperature exceeds 150°C. Charging will resume when the die temperature has cooled by approximately 10°C.

## 5.0 DETAILED DESCRIPTION

### 5.1 Analog Circuitry

#### 5.1.1 BATTERY MANAGEMENT INPUT SUPPLY ( $V_{DD}$ )

The  $V_{DD}$  input is the input supply to the MCP73831/2. The MCP73831/2 automatically enter a Power-Down mode if the voltage on the  $V_{DD}$  input falls below the UVLO voltage ( $V_{STOP}$ ). This feature prevents draining the battery pack when the  $V_{DD}$  supply is not present.

#### 5.1.2 CURRENT REGULATION SET (PROG)

Fast charge current regulation can be scaled by placing a programming resistor ( $R_{PROG}$ ) from the PROG input to  $V_{SS}$ . The program resistor and the charge current are calculated using the following equation:

$$I_{REG} = \frac{1000V}{R_{PROG}}$$

Where:

$$\begin{aligned} R_{PROG} &= \text{kOhms} \\ I_{REG} &= \text{milliampere} \end{aligned}$$

The preconditioning trickle charge current and the charge termination current are ratiometric to the fast charge current based on the selected device options.

#### 5.1.3 BATTERY CHARGE CONTROL OUTPUT ( $V_{BAT}$ )

The battery charge control output is the drain terminal of an internal P-channel MOSFET. The MCP73831/2 provide constant current and voltage regulation to the battery pack by controlling this MOSFET in the linear region. The battery charge control output should be connected to the positive terminal of the battery pack.

### 5.2 Digital Circuitry

#### 5.2.1 STATUS INDICATOR (STAT)

The charge status output of the MCP73831 has three different states: High (H), Low (L), and High-Impedance (Hi-Z). The charge status output of the MCP73832 is open-drain, and, as such, has two different states: Low (L), and High-Impedance (Hi-Z). The charge status output can be used to illuminate 1, 2, or tri-color LEDs. Optionally, the charge status output can be used as an interface to a host microcontroller.

Table 5-1 summarize the state of the status output during a charge cycle..

**TABLE 5-1: STATUS OUTPUT**

Charge Cycle State	STAT1	
	MCP73831	MCP73832
Shutdown	Hi-Z	Hi-Z
No Battery Present	Hi-Z	Hi-Z
Preconditioning	L	L
Constant-Current Fast Charge	L	L
Constant Voltage	L	L
Charge Complete – Standby	H	Hi-Z

#### 5.2.2 DEVICE DISABLE (PROG)

The current regulation set input pin (PROG) can be used to terminate a charge at any time during the charge cycle, as well as to initiate a charge cycle or initiate a recharge cycle.

Placing a programming resistor from the PROG input to  $V_{SS}$  enables the device. Allowing the PROG input to float or by applying a logic-high input signal, disables the device and terminates a charge cycle. When disabled, the device's supply current is reduced to 25  $\mu$ A, typically.

# MCP73831/2

---

NOTES:



## 6.0 APPLICATIONS

The MCP73831/2 are designed to operate in conjunction with a host microcontroller or in a stand-alone application. The MCP73831/2 provide the preferred charge algorithm for Lithium-Ion and Lithium-Polymer

cells constant current followed by constant voltage. [Figure 6-1](#) depicts a typical stand-alone application circuit, while [Figures 6-2](#) and [6-3](#) depict the accompanying charge profile.



**FIGURE 6-1:** Typical Application Circuit.



**FIGURE 6-2:** Typical Charge Profile (180 mAh Battery).



**FIGURE 6-3:** Typical Charge Profile in Thermal Regulation (1000 mAh Battery).

## 6.1 Application Circuit Design

Due to the low efficiency of linear charging, the most important factors are thermal design and cost, which are a direct function of the input voltage, output current and thermal impedance between the battery charger and the ambient cooling air. The worst-case situation is when the device has transitioned from the Preconditioning mode to the Constant-Current mode. In this situation, the battery charger has to dissipate the maximum power. A trade-off must be made between the charge current, cost and thermal requirements of the charger.

### 6.1.1 COMPONENT SELECTION

Selection of the external components in [Figure 6-1](#) is crucial to the integrity and reliability of the charging system. The following discussion is intended as a guide for the component selection process.

#### 6.1.1.1 Current Programming Resistor ( $R_{PROG}$ )

The preferred fast charge current for Lithium-Ion cells is at the 1C rate, with an absolute maximum current at the 2C rate. For example, a 500 mAh battery pack has a preferred fast charge current of 500 mA. Charging at this rate provides the shortest charge cycle times without degradation to the battery pack performance or life.

# MCP73831/2

## 6.1.1.2 Thermal Considerations

The worst-case power dissipation in the battery charger occurs when the input voltage is at the maximum and the device has transitioned from the Preconditioning mode to the Constant-Current mode. In this case, the power dissipation is:

$$PowerDissipation = (V_{DDMAX} - V_{PTHMIN}) \times I_{REGMAX}$$

Where:

- $V_{DDMAX}$  = the maximum input voltage
- $I_{REGMAX}$  = the maximum fast charge current
- $V_{PTHMIN}$  = the minimum transition threshold voltage

Power dissipation with a 5V,  $\pm 10\%$  input voltage source is:

$$PowerDissipation = (5.5V - 2.7V) \times 550mA = 1.54W$$

This power dissipation with the battery charger in the SOT-23-5 package will cause thermal regulation to be entered as depicted in [Figure 6-3](#). Alternatively, the 2mm x 3mm DFN package could be utilized to reduce charge cycle times.

## 6.1.1.3 External Capacitors

The MCP73831/2 are stable with or without a battery load. In order to maintain good AC stability in the Constant-Voltage mode, a minimum capacitance of 4.7  $\mu F$  is recommended to bypass the  $V_{BAT}$  pin to  $V_{SS}$ . This capacitance provides compensation when there is no battery load. In addition, the battery and interconnections appear inductive at high frequencies. These elements are in the control feedback loop during Constant-Voltage mode. Therefore, the bypass capacitance may be necessary to compensate for the inductive nature of the battery pack.

Virtually any good quality output filter capacitor can be used, independent of the capacitor's minimum Effective Series Resistance (ESR) value. The actual value of the capacitor (and its associated ESR) depends on the output load current. A 4.7  $\mu F$  ceramic, tantalum or aluminum electrolytic capacitor at the output is usually sufficient to ensure stability for output currents up to a 500 mA.

## 6.1.1.4 Reverse-Blocking Protection

The MCP73831/2 provide protection from a faulted or shorted input. Without the protection, a faulted or shorted input would discharge the battery pack through the body diode of the internal pass transistor.

## 6.1.1.5 Charge Inhibit

The current regulation set input pin (PROG) can be used to terminate a charge at any time during the charge cycle, as well as to initiate a charge cycle or initiate a recharge cycle.

Placing a programming resistor from the PROG input to  $V_{SS}$  enables the device. Allowing the PROG input to float or by applying a logic-high input signal, disables the device and terminates a charge cycle. When disabled, the device's supply current is reduced to 25  $\mu A$ , typically.

## 6.1.1.6 Charge Status Interface

A status output provides information on the state of charge. The output can be used to illuminate external LEDs or interface to a host microcontroller. Refer to [Table 5-1](#) for a summary of the state of the status output during a charge cycle.

## 6.2 PCB Layout Issues

For optimum voltage regulation, place the battery pack as close as possible to the device's  $V_{BAT}$  and  $V_{SS}$  pins. This is recommended to minimize voltage drops along the high current-carrying PCB traces.

If the PCB layout is used as a heatsink, adding many vias in the heatsink pad can help conduct more heat to the backplane of the PCB, thus reducing the maximum junction temperature. [Figures 6-4](#) and [6-5](#) depict a typical layout with PCB heatsinking.

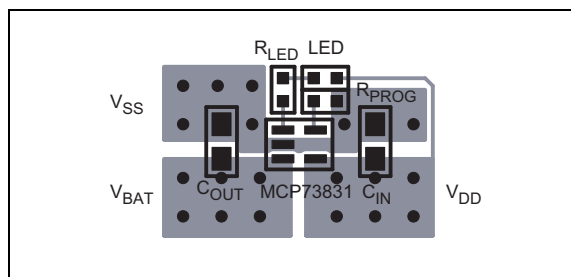

**FIGURE 6-4:** Typical Layout (Top).

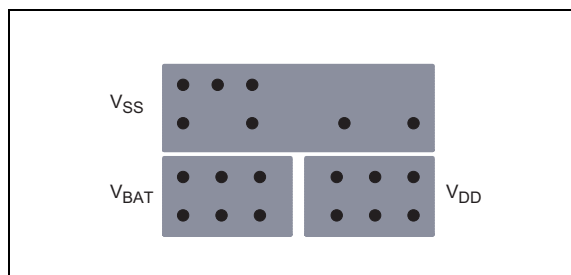

**FIGURE 6-5:** Typical Layout (Bottom).

## 7.0 PACKAGING INFORMATION

### 7.1 Package Marking Information

8-Lead DFN (2 mm x 3 mm)



Device	Code
MCP73831T-2ACI/MC	AAE
MCP73831T-2ATI/MC	AAF
MCP73831T-2DCI/MC	AAG
MCP73831T-3ACI/MC	AAH
MCP73831T-4ADI/MC	AAJ
MCP73831T-5ACI/MC	AAK
MCP73832T-2ACI/MC	AAL
MCP73832T-2ATI/MC	AAM
MCP73832T-2DCI/MC	AAP
MCP73832T-3ACI/MC	AAQ
MCP73832T-4ADI/MC	AAR
MCP73832T-5ACI/MC	AAS

Example:

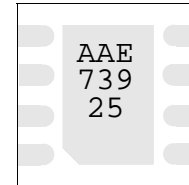

**Note:** Applies to 8-Lead DFN

5-Lead SOT-23

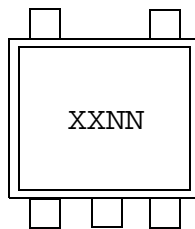

Device	Code
MCP73831T-2ACI/OT	KDNN
MCP73831T-2ATI/OT	KENN
MCP73831T-2DCI/OT	KFNN
MCP73831T-3ACI/OT	KGNN
MCP73831T-4ADI/OT	KHNN
MCP73831T-5ACI/OT	KJNN
MCP73832T-2ACI/OT	KKNN
MCP73832T-2ATI/OT	KLNN
MCP73832T-2DCI/OT	KMNN
MCP73832T-3ACI/OT	KPNN
MCP73832T-4ADI/OT	KQNN
MCP73832T-5ACI/OT	KRNN
MCP73832T-2DFI/OT	LUNN

Example:

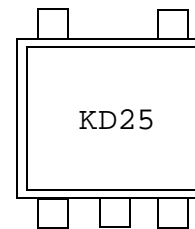

**Note:** Applies to 5-Lead SOT-23

<b>Legend:</b>	XX...X	Customer-specific information
	Y	Year code (last digit of calendar year)
	YY	Year code (last 2 digits of calendar year)
	WW	Week code (week of January 1 is week '01')
	NNN	Alphanumeric traceability code
	(e3)	Pb-free JEDEC designator for Matte Tin (Sn)
	*	This package is Pb-free. The Pb-free JEDEC designator (e3) can be found on the outer packaging for this package.

**Note:** In the event the full Microchip part number cannot be marked on one line, it will be carried over to the next line, thus limiting the number of available characters for customer-specific information.

# MCP73831/2

## 8-Lead Plastic Dual Flat, No Lead Package (MC) – 2x3x0.9 mm Body [DFN]

**Note:** For the most current package drawings, please see the Microchip Packaging Specification located at <http://www.microchip.com/packaging>



Dimension Limits	Units	MILLIMETERS		
		MIN	NOM	MAX
Number of Pins	N	8		
Pitch	e	0.50 BSC		
Overall Height	A	0.80	0.90	1.00
Standoff	A1	0.00	0.02	0.05
Contact Thickness	A3	0.20 REF		
Overall Length	D	2.00 BSC		
Overall Width	E	3.00 BSC		
Exposed Pad Length	D2	1.30	–	1.75
Exposed Pad Width	E2	1.50	–	1.90
Contact Width	b	0.18	0.25	0.30
Contact Length	L	0.30	0.40	0.50
Contact-to-Exposed Pad	K	0.20	–	–

**Notes:**

- Pin 1 visual index feature may vary, but must be located within the hatched area.
- Package may have one or more exposed tie bars at ends.
- Package is saw singulated.
- Dimensioning and tolerancing per ASME Y14.5M.

BSC: Basic Dimension. Theoretically exact value shown without tolerances.

REF: Reference Dimension, usually without tolerance, for information purposes only.

Microchip Technology Drawing C04-123B

## 8-Lead Plastic Dual Flat, No Lead Package (MC) – 2x3x0.9 mm Body [DFN]

**Note:** For the most current package drawings, please see the Microchip Packaging Specification located at <http://www.microchip.com/packaging>

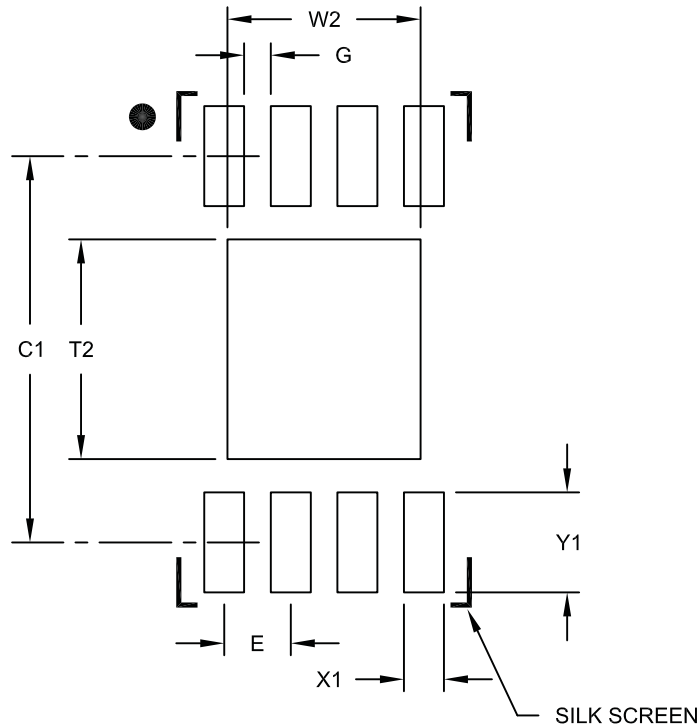

### RECOMMENDED LAND PATTERN

Dimension Limits	Units	MILLIMETERS		
		MIN	NOM	MAX
Contact Pitch	E	0.50 BSC		
Optional Center Pad Width	W2			1.45
Optional Center Pad Length	T2			1.75
Contact Pad Spacing	C1		2.90	
Contact Pad Width (X8)	X1			0.30
Contact Pad Length (X8)	Y1			0.75
Distance Between Pads	G	0.20		

**Notes:**

1. Dimensioning and tolerancing per ASME Y14.5M

BSC: Basic Dimension. Theoretically exact value shown without tolerances.

Microchip Technology Drawing No. C04-2123A

# MCP73831/2

## 5-Lead Plastic Small Outline Transistor (OT) [SOT-23]

**Note:** For the most current package drawings, please see the Microchip Packaging Specification located at <http://www.microchip.com/packaging>

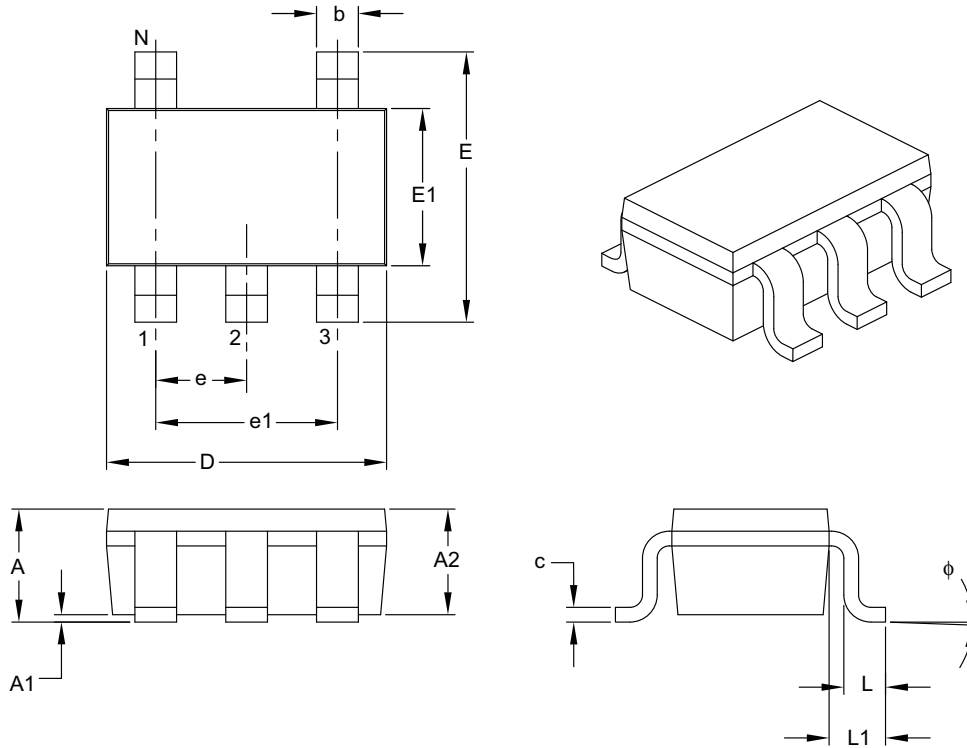

Dimension Limits	Units	MILLIMETERS		
		MIN	NOM	MAX
Number of Pins	N	5		
Lead Pitch	e	0.95 BSC		
Outside Lead Pitch	e1	1.90 BSC		
Overall Height	A	0.90	–	1.45
Molded Package Thickness	A2	0.89	–	1.30
Standoff	A1	0.00	–	0.15
Overall Width	E	2.20	–	3.20
Molded Package Width	E1	1.30	–	1.80
Overall Length	D	2.70	–	3.10
Foot Length	L	0.10	–	0.60
Footprint	L1	0.35	–	0.80
Foot Angle	$\phi$	0°	–	30°
Lead Thickness	c	0.08	–	0.26
Lead Width	b	0.20	–	0.51

**Notes:**

- Dimensions D and E1 do not include mold flash or protrusions. Mold flash or protrusions shall not exceed 0.127 mm per side.
- Dimensioning and tolerancing per ASME Y14.5M.

BSC: Basic Dimension. Theoretically exact value shown without tolerances.

Microchip Technology Drawing C04-091B

## APPENDIX A: REVISION HISTORY

### Revision E (September 2008)

The following is the list of modifications:

1. **Package Types:** Changed DFN pinout diagram.
2. **1.0 “Electrical Characteristics”:** Changed “Charge Impedance Range from 20 k $\Omega$  to 67 k $\Omega$ .”
3. **1.0 “Electrical Characteristics”:** Misc. Formatting changes.
4. **Section 2.0 “Typical Performance Curves”:** Updated Figure 2-4.
5. **Section 3.0 “Pin Description”:** Added Exposed Pad pin to table and added **Section 3.6 “Exposed Thermal Pad (EP)”**.
6. Updated **Appendix A: “Revision History”**
7. Added Land Pattern Package Outline Drawing for 2x3 DFN package.
8. Pagination fixes throughout document per Marcom Standards.

### Revision D (April 2008)

The following is the list of modifications:

1. Changed Charge Termination Current Ratio to 8.5% minimum and 11.5% maximum.

### Revision C (October 2007)

The following is the list of modifications:

1. Numerous edits throughout document.
2. Added note to Temperature Specifications table.
3. Updated Figure 2-4.

### Revision B (March 2006)

The following is the list of modifications:

1. Added MCP73832 through document.

### Revision A (November 2005)

- Original Release of this Document.

# MCP73831/2

---

NOTES:



## PRODUCT IDENTIFICATION SYSTEM

To order or obtain information, e.g., on pricing or delivery, refer to the factory or the listed sales office.

<u>PART NO.</u>	<u>X</u>	<u>XX</u>	<u>X</u>	<u>/XX</u>																									
Device	V <sub>REG</sub>	Options	Temperature Range	Package																									
<p><b>Device:</b></p> <p>MCP73831: Single-Cell Charge Controller  MCP73831T: Single-Cell Charge Controller (Tape and Reel)  MCP73832: Single-Cell Charge Controller  MCP73832T: Single-Cell Charge Controller (Tape and Reel)</p>																													
<p><b>Regulation Voltage:</b></p> <table border="0"> <tr> <td><b>Code</b></td> <td><b>V<sub>REG</sub></b></td> </tr> <tr> <td>2</td> <td>= 4.20V</td> </tr> <tr> <td>3</td> <td>= 4.35V</td> </tr> <tr> <td>4</td> <td>= 4.40V</td> </tr> <tr> <td>5</td> <td>= 4.50V</td> </tr> </table>					<b>Code</b>	<b>V<sub>REG</sub></b>	2	= 4.20V	3	= 4.35V	4	= 4.40V	5	= 4.50V															
<b>Code</b>	<b>V<sub>REG</sub></b>																												
2	= 4.20V																												
3	= 4.35V																												
4	= 4.40V																												
5	= 4.50V																												
<p><b>Options: *</b></p> <table border="0"> <tr> <td><b>Code</b></td> <td><b>I<sub>PREG</sub>/I<sub>REG</sub></b></td> <td><b>V<sub>PTH</sub>/V<sub>REG</sub></b></td> <td><b>I<sub>TERM</sub>/I<sub>REG</sub></b></td> <td><b>V<sub>RTH</sub>/V<sub>REG</sub></b></td> </tr> <tr> <td>AC</td> <td>10</td> <td>66.5</td> <td>7.5</td> <td>96.5</td> </tr> <tr> <td>AD</td> <td>10</td> <td>66.5</td> <td>7.5</td> <td>94</td> </tr> <tr> <td>AT</td> <td>10</td> <td>71.5</td> <td>20</td> <td>94</td> </tr> <tr> <td>DC</td> <td>100</td> <td>x</td> <td>7.5</td> <td>96.5</td> </tr> </table> <p>* Consult Factory for Alternative Device Options</p>					<b>Code</b>	<b>I<sub>PREG</sub>/I<sub>REG</sub></b>	<b>V<sub>PTH</sub>/V<sub>REG</sub></b>	<b>I<sub>TERM</sub>/I<sub>REG</sub></b>	<b>V<sub>RTH</sub>/V<sub>REG</sub></b>	AC	10	66.5	7.5	96.5	AD	10	66.5	7.5	94	AT	10	71.5	20	94	DC	100	x	7.5	96.5
<b>Code</b>	<b>I<sub>PREG</sub>/I<sub>REG</sub></b>	<b>V<sub>PTH</sub>/V<sub>REG</sub></b>	<b>I<sub>TERM</sub>/I<sub>REG</sub></b>	<b>V<sub>RTH</sub>/V<sub>REG</sub></b>																									
AC	10	66.5	7.5	96.5																									
AD	10	66.5	7.5	94																									
AT	10	71.5	20	94																									
DC	100	x	7.5	96.5																									
<p><b>Temperature Range:</b></p> <p>I = -40°C to +85°C (Industrial)</p>																													
<p><b>Package:</b></p> <p>MC = Dual-Flat, No-Lead (2x3 mm body), 8-Lead  OT = Small Outline Transistor (SOT23), 5-Lead</p>																													
<p><b>Examples: *</b></p> <p>a) MCP73831-2ACI/OT: 4.20V V<sub>REG</sub> Options AC, 5LD SOT23 Pkg  b) MCP73831T-2ACI/OT: Tape and Reel, 4.20V V<sub>REG</sub> Options AC, 5LD SOT23 Pkg  c) MCP73832-2ACI/MC: 4.20V V<sub>REG</sub> Options AC, 8LD DFN Package  d) MCP73832T-2ACI/MC: Tape and Reel, 4.20V V<sub>REG</sub> Options AC, 8LD DFN Package</p> <p>a) MCP73831-2ATI/OT: 4.20V V<sub>REG</sub> Options AT, 5LD SOT23 Pkg  b) MCP73831T-2ATI/OT: Tape and Reel, 4.20V V<sub>REG</sub> Options AT, 5LD SOT23 Pkg  c) MCP73832-2ATI/MC: 4.20V V<sub>REG</sub> Options AT, 8LD DFN Package  d) MCP73832T-2ATI/MC: Tape and Reel, 4.20V V<sub>REG</sub> Options AT, 8LD DFN Package</p> <p>a) MCP73831-2DCI/OT: 4.20V V<sub>REG</sub> Options DC, 5LD SOT23 Pkg  b) MCP73831T-2DCI/OT: Tape and Reel, 4.20V V<sub>REG</sub> Options DC, 5LD SOT23 Pkg  c) MCP73832-2DCI/MC: 4.20V V<sub>REG</sub> Options DC, 8LD DFN Package  d) MCP73832T-2DCI/MC: Tape and Reel, 4.20V V<sub>REG</sub> Options DC, 8LD DFN Package</p> <p>a) MCP73831-3ACI/OT: 4.35V V<sub>REG</sub> Options AC, 5LD SOT23 Pkg  b) MCP73831T-3ACI/OT: Tape and Reel, 4.35V V<sub>REG</sub> Options AC, 5LD SOT23 Pkg  c) MCP73832-3ACI/MC: 4.35V V<sub>REG</sub> Options AC, 8LD DFN Package  d) MCP73832T-3ACI/MC: Tape and Reel, 4.35V V<sub>REG</sub> Options AC, 8LD DFN Package</p> <p>a) MCP73831-4ADI/OT: 4.40V V<sub>REG</sub> Options AD, 5LD SOT23 Pkg  b) MCP73831T-4ADI/OT: Tape and Reel, 4.40V V<sub>REG</sub> Options AD, 5LD SOT23 Pkg  c) MCP73832-4ADI/MC: 4.40V V<sub>REG</sub> Options AD, 8LD DFN Package  d) MCP73832T-4ADI/MC: Tape and Reel, 4.40V V<sub>REG</sub> Options AD, 8LD DFN Package</p> <p>a) MCP73831-5ACI/OT: 4.50V V<sub>REG</sub> Options AC, 5LD SOT23 Pkg  b) MCP73831T-5ACI/OT: Tape and Reel, 4.50V V<sub>REG</sub> Options AC, 5LD SOT23 Pkg  c) MCP73832-5ACI/MC: 4.50V V<sub>REG</sub> Options AC, 8LD DFN Package  d) MCP73832T-5ACI/MC: Tape and Reel, 4.50V V<sub>REG</sub> Options AC, 8LD DFN Package</p> <p>* Consult Factory for Alternate Device Options</p>																													

# MCP73831/2

---

NOTES:

---

**Note the following details of the code protection feature on Microchip devices:**

- Microchip products meet the specification contained in their particular Microchip Data Sheet.
- Microchip believes that its family of products is one of the most secure families of its kind on the market today, when used in the intended manner and under normal conditions.
- There are dishonest and possibly illegal methods used to breach the code protection feature. All of these methods, to our knowledge, require using the Microchip products in a manner outside the operating specifications contained in Microchip's Data Sheets. Most likely, the person doing so is engaged in theft of intellectual property.
- Microchip is willing to work with the customer who is concerned about the integrity of their code.
- Neither Microchip nor any other semiconductor manufacturer can guarantee the security of their code. Code protection does not mean that we are guaranteeing the product as “unbreakable.”

Code protection is constantly evolving. We at Microchip are committed to continuously improving the code protection features of our products. Attempts to break Microchip's code protection feature may be a violation of the Digital Millennium Copyright Act. If such acts allow unauthorized access to your software or other copyrighted work, you may have a right to sue for relief under that Act.

---

Information contained in this publication regarding device applications and the like is provided only for your convenience and may be superseded by updates. It is your responsibility to ensure that your application meets with your specifications. MICROCHIP MAKES NO REPRESENTATIONS OR WARRANTIES OF ANY KIND WHETHER EXPRESS OR IMPLIED, WRITTEN OR ORAL, STATUTORY OR OTHERWISE, RELATED TO THE INFORMATION, INCLUDING BUT NOT LIMITED TO ITS CONDITION, QUALITY, PERFORMANCE, MERCHANTABILITY OR FITNESS FOR PURPOSE. Microchip disclaims all liability arising from this information and its use. Use of Microchip devices in life support and/or safety applications is entirely at the buyer's risk, and the buyer agrees to defend, indemnify and hold harmless Microchip from any and all damages, claims, suits, or expenses resulting from such use. No licenses are conveyed, implicitly or otherwise, under any Microchip intellectual property rights.

**Trademarks**

The Microchip name and logo, the Microchip logo, Accuron, dsPIC, KEELOQ, KEELOQ logo, MPLAB, PIC, PICmicro, PICSTART, rfPIC, SmartShunt and UNI/O are registered trademarks of Microchip Technology Incorporated in the U.S.A. and other countries.

FilterLab, Linear Active Thermistor, MXDEV, MXLAB, SEEVAL, SmartSensor and The Embedded Control Solutions Company are registered trademarks of Microchip Technology Incorporated in the U.S.A.

Analog-for-the-Digital Age, Application Maestro, CodeGuard, dsPICDEM, dsPICDEM.net, dsPICworks, dsSPEAK, ECAN, ECONOMONITOR, FanSense, In-Circuit Serial Programming, ICSP, ICEPIC, Mindi, MiWi, MPASM, MPLAB Certified logo, MPLIB, MPLINK, mTouch, PICkit, PICDEM, PICDEM.net, PICtail, PIC<sup>32</sup> logo, PowerCal, PowerInfo, PowerMate, PowerTool, REAL ICE, rfLAB, Select Mode, Total Endurance, WiperLock and ZENA are trademarks of Microchip Technology Incorporated in the U.S.A. and other countries.

SQTP is a service mark of Microchip Technology Incorporated in the U.S.A.

All other trademarks mentioned herein are property of their respective companies.

© 2008, Microchip Technology Incorporated, Printed in the U.S.A., All Rights Reserved.

 Printed on recycled paper.

**QUALITY MANAGEMENT SYSTEM**  
**CERTIFIED BY DNV**  
**== ISO/TS 16949:2002 ==**

*Microchip received ISO/TS-16949:2002 certification for its worldwide headquarters, design and wafer fabrication facilities in Chandler and Tempe, Arizona; Gresham, Oregon and design centers in California and India. The Company's quality system processes and procedures are for its PIC® MCUs and dsPIC® DSCs, KEELOQ® code hopping devices, Serial EEPROMs, microperipherals, nonvolatile memory and analog products. In addition, Microchip's quality system for the design and manufacture of development systems is ISO 9001:2000 certified.*



## WORLDWIDE SALES AND SERVICE

### AMERICAS

**Corporate Office**  
2355 West Chandler Blvd.  
Chandler, AZ 85224-6199  
Tel: 480-792-7200  
Fax: 480-792-7277  
Technical Support:  
<http://support.microchip.com>  
Web Address:  
[www.microchip.com](http://www.microchip.com)

**Atlanta**  
Duluth, GA  
Tel: 678-957-9614  
Fax: 678-957-1455

**Boston**  
Westborough, MA  
Tel: 774-760-0087  
Fax: 774-760-0088

**Chicago**  
Itasca, IL  
Tel: 630-285-0071  
Fax: 630-285-0075

**Dallas**  
Addison, TX  
Tel: 972-818-7423  
Fax: 972-818-2924

**Detroit**  
Farmington Hills, MI  
Tel: 248-538-2250  
Fax: 248-538-2260

**Kokomo**  
Kokomo, IN  
Tel: 765-864-8360  
Fax: 765-864-8387

**Los Angeles**  
Mission Viejo, CA  
Tel: 949-462-9523  
Fax: 949-462-9608

**Santa Clara**  
Santa Clara, CA  
Tel: 408-961-6444  
Fax: 408-961-6445

**Toronto**  
Mississauga, Ontario,  
Canada  
Tel: 905-673-0699  
Fax: 905-673-6509

### ASIA/PACIFIC

**Asia Pacific Office**  
Suites 3707-14, 37th Floor  
Tower 6, The Gateway  
Harbour City, Kowloon  
Hong Kong  
Tel: 852-2401-1200  
Fax: 852-2401-3431

**Australia - Sydney**  
Tel: 61-2-9868-6733  
Fax: 61-2-9868-6755

**China - Beijing**  
Tel: 86-10-8528-2100  
Fax: 86-10-8528-2104

**China - Chengdu**  
Tel: 86-28-8665-5511  
Fax: 86-28-8665-7889

**China - Hong Kong SAR**  
Tel: 852-2401-1200  
Fax: 852-2401-3431

**China - Nanjing**  
Tel: 86-25-8473-2460  
Fax: 86-25-8473-2470

**China - Qingdao**  
Tel: 86-532-8502-7355  
Fax: 86-532-8502-7205

**China - Shanghai**  
Tel: 86-21-5407-5533  
Fax: 86-21-5407-5066

**China - Shenyang**  
Tel: 86-24-2334-2829  
Fax: 86-24-2334-2393

**China - Shenzhen**  
Tel: 86-755-8203-2660  
Fax: 86-755-8203-1760

**China - Wuhan**  
Tel: 86-27-5980-5300  
Fax: 86-27-5980-5118

**China - Xiamen**  
Tel: 86-592-2388138  
Fax: 86-592-2388130

**China - Xian**  
Tel: 86-29-8833-7252  
Fax: 86-29-8833-7256

**China - Zhuhai**  
Tel: 86-756-3210040  
Fax: 86-756-3210049

### ASIA/PACIFIC

**India - Bangalore**  
Tel: 91-80-4182-8400  
Fax: 91-80-4182-8422

**India - New Delhi**  
Tel: 91-11-4160-8631  
Fax: 91-11-4160-8632

**India - Pune**  
Tel: 91-20-2566-1512  
Fax: 91-20-2566-1513

**Japan - Yokohama**  
Tel: 81-45-471- 6166  
Fax: 81-45-471-6122

**Korea - Daegu**  
Tel: 82-53-744-4301  
Fax: 82-53-744-4302

**Korea - Seoul**  
Tel: 82-2-554-7200  
Fax: 82-2-558-5932 or  
82-2-558-5934

**Malaysia - Kuala Lumpur**  
Tel: 60-3-6201-9857  
Fax: 60-3-6201-9859

**Malaysia - Penang**  
Tel: 60-4-227-8870  
Fax: 60-4-227-4068

**Philippines - Manila**  
Tel: 63-2-634-9065  
Fax: 63-2-634-9069

**Singapore**  
Tel: 65-6334-8870  
Fax: 65-6334-8850

**Taiwan - Hsin Chu**  
Tel: 886-3-572-9526  
Fax: 886-3-572-6459

**Taiwan - Kaohsiung**  
Tel: 886-7-536-4818  
Fax: 886-7-536-4803

**Taiwan - Taipei**  
Tel: 886-2-2500-6610  
Fax: 886-2-2508-0102

**Thailand - Bangkok**  
Tel: 66-2-694-1351  
Fax: 66-2-694-1350

### EUROPE

**Austria - Wels**  
Tel: 43-7242-2244-39  
Fax: 43-7242-2244-393

**Denmark - Copenhagen**  
Tel: 45-4450-2828  
Fax: 45-4485-2829

**France - Paris**  
Tel: 33-1-69-53-63-20  
Fax: 33-1-69-30-90-79

**Germany - Munich**  
Tel: 49-89-627-144-0  
Fax: 49-89-627-144-44

**Italy - Milan**  
Tel: 39-0331-742611  
Fax: 39-0331-466781

**Netherlands - Drunen**  
Tel: 31-416-690399  
Fax: 31-416-690340

**Spain - Madrid**  
Tel: 34-91-708-08-90  
Fax: 34-91-708-08-91

**UK - Wokingham**  
Tel: 44-118-921-5869  
Fax: 44-118-921-5820

## X-ON Electronics

Largest Supplier of Electrical and Electronic Components

*Click to view similar products for [16-bit Microcontrollers - MCU category](#):*

*Click to view products by [Microchip manufacturer](#):*

Other Similar products are found below :

[MB90F036APMC-GSE1](#) [MB90F342CASPMC-GSE1](#) [MB90F345CESPMC-GE1](#) [MB90F349CAPFR-GSE1](#) [MB90F428GCPFR-GSE1](#)  
[MB90F462APFM-GE1](#) [MB90F462APMC-G-SNE1](#) [MB90F497GPF-GE1](#) [MB90F546GSPFR-GE1](#) [MB90F947APFR-GS-SPE1](#)  
[MB96F346RSBPMC-GS-N2E2](#) [MB96F683RBPMC-GSAE1](#) [R5F104ACASP#V0](#) [R5F11BGEAFB#30](#) [S912ZVFP64F1VLL](#)  
[R4F24268NVRFQV](#) [R5F11B7EANA#U0](#) [R5F21172DSP#U0](#) [M30622F8PGP#U3C](#) [MB90092PF-G-BNDE1](#) [MB90F335APMC1-G-SPE1](#)  
[MB90F342CASPF-R-GS-N2E1](#) [MB90F345CAPFR-GSE1](#) [MB90F543GPF-GE1](#) [MB90F546GSPF-GE1](#) [MB90F568PMCR-GE1](#)  
[MB90F594APFR-GE1](#) [MB90F882ASPMC-GE1](#) [MB96F346RSAPQCR-GS-N2E2](#) [MB96F387RSBPMC-GSE2](#) [MB96F387RSBPMC-GS-](#)  
[N2E2](#) [MB96F395RSAPMC-GSE2](#) [MB96F623RBPMC1-GSE1](#) [MB96F635RBPMC-GSE1](#) [MB96F646RBPMC-GSE1](#)  
[XE167F96F66LACFXUMA1](#) [MB96F696RBPMC-GSAE1](#) [MB96F635RBPMC-GSAE1](#) [MB96F018RBPMC-GSE1](#) [MB90F962SPMCR-GE1](#)  
[MB90F867ASPFR-GE1](#) [MB90F543GPF-G-FLE1](#) [MB90F345CESPF-GE1](#) [M30290FCHP#U3A](#) [HD64F3672FPV](#) [R5F104AEASP#V0](#)  
[R5F100BCANA#U0](#) [R5F100BFANA#U0](#) [R5F100ACASP#V0](#) [R5F117BCGFP#30](#)