

Machine safety

Preventa

Ingenious and innovative, Preventa safety solutions provide maximum protection for all the safety functions of your automation system.

Select Preventa:

- To export your machines to any location in the world, you expect solutions that are both *approved* and *conform* to international standards.
- To maintain productivity, you need solutions *quickly* to assist you, irrespective of the circumstances.
- You seek *universal* solutions to respond to the diversity of your customers' requirements and, at the same time, *optimise* your stock.

Full safety chain:

Since a perfect safety system does not exist, the latest standards relating to functional safety and voluntary application provide new risk management methods to be used from the design stage by applying principles such as the safety integrity level (SIL) as well as extensively using established operating safety concepts.

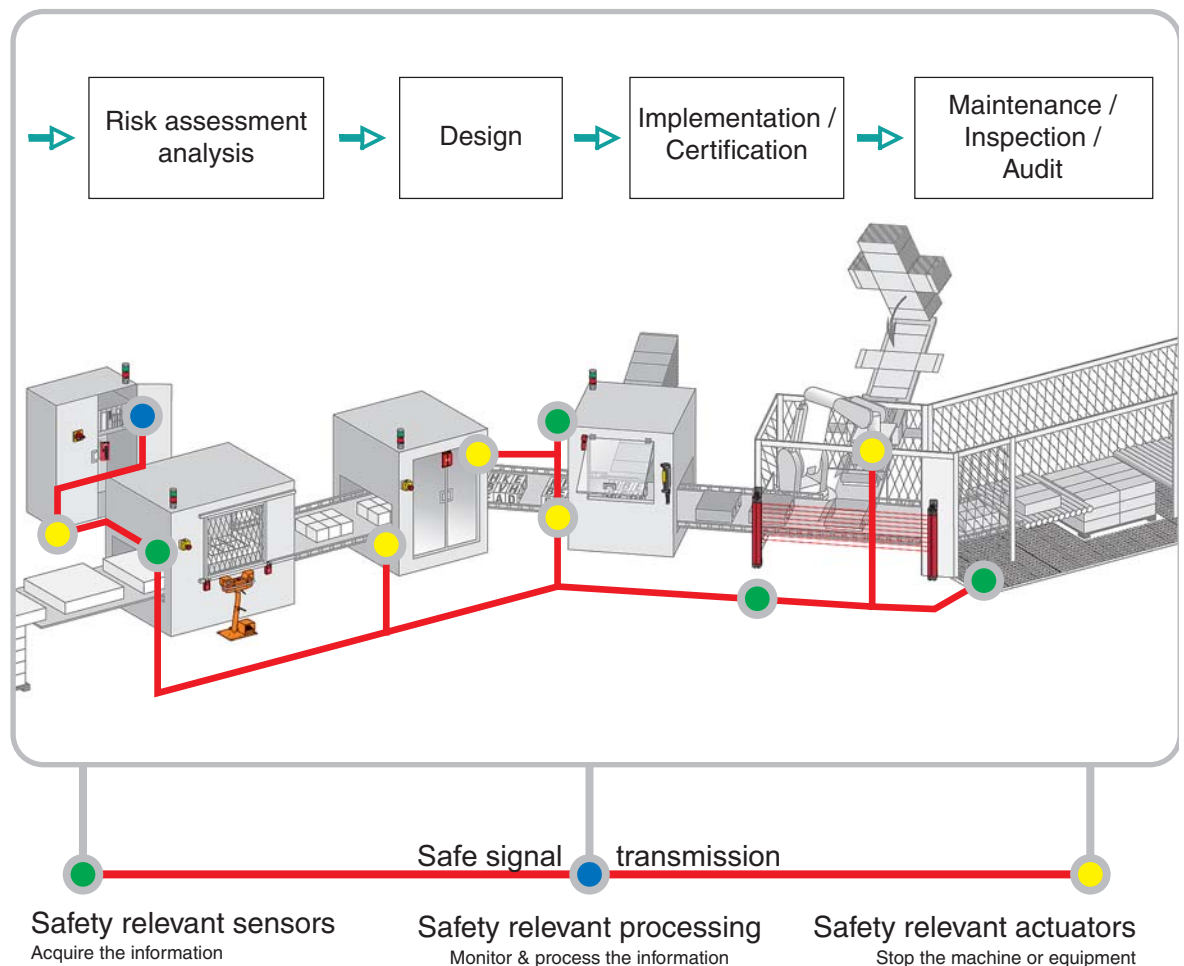

Contents

Safety standard 9/2 to 9/9

Automation 9/6 to 9/11

- Safety PLCs
- Safety controllers and modules

AS-Interface Safety at work 9/12 and 9/13

- Safety monitors and interfaces

Detection 9/14 to 9/21

- Safety switches
- Safety limit switches and mats
- Safety light curtains

Operator dialogue 9/22 to 9/26

- Emergency stops
- Foot switches
- Two-hand control and enabling switches
- Products for explosive atmospheres
(see chapter 10 “Explosive Atmospheres”)

Motor control 9/27 to 9/29

- Switch disconnectors
- TeSys motor starters

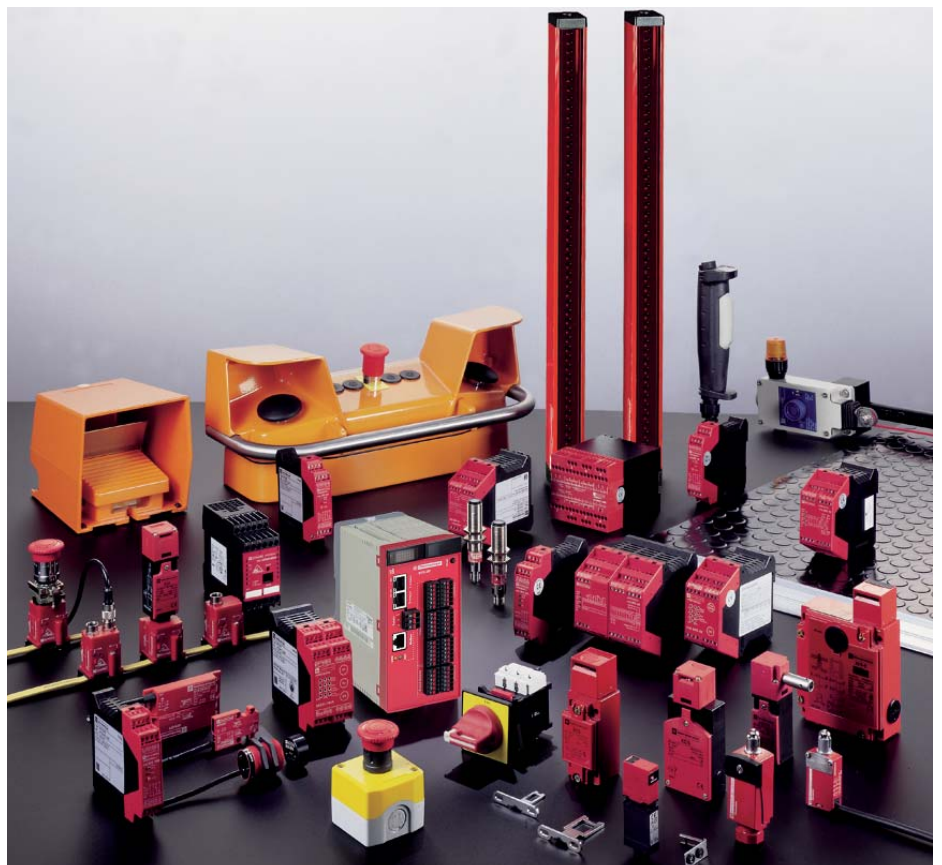

Functional Safety and Safety Integrity Level (SIL)

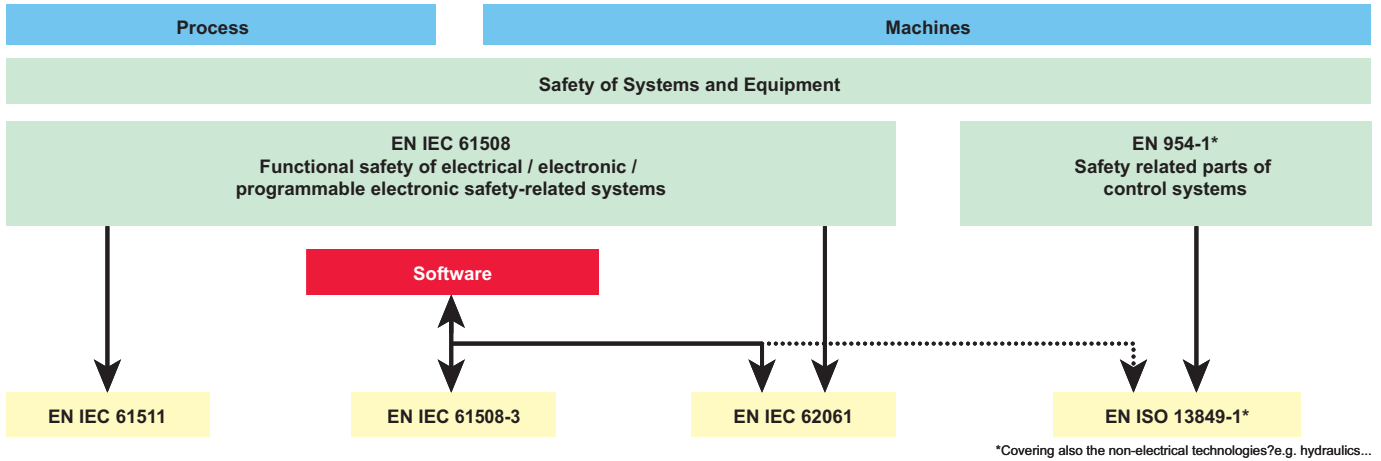

Risk reduction according to EN IEC 61508

- **Safety** is achieved by risk reduction (for those hazards that cannot be designed-out).
- **Residual risk** is the risk remaining after protective measures have been taken.
- **Protective measures** realised by E/E/PE safety related systems contribute to risk reduction.

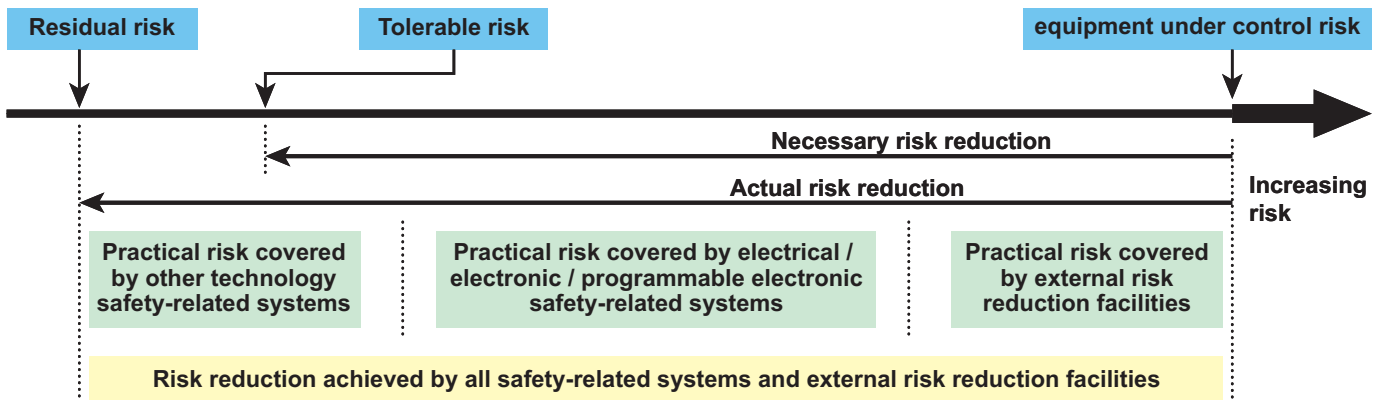

For machinery, the probability of dangerous failures per hour of a control system is denoted in EN IEC 62061 as the PFHD

- The rate of failures λ can be expressed as follows:

$$\lambda = \lambda_s + \lambda_{dd} + \lambda_{du}$$
- The calculation of the PFHD for a system or subsystem depends on several parameters:
 - the dangerous failure rate (λ_d) of the subsystem elements
 - the fault tolerance (e.g. redundancy) of the system
 - the diagnostic test interval (T2)
 - the proof test interval (T1) or lifetime whichever is smaller
 - the susceptibility to common cause failures (β)
- For each of the four different logical architectures A to D there is a different formula to calculate the PFHD. (see EN IEC 62061) (The principal relationship is: $PFHD = \lambda_d \times 1h$)

λ_s = rate of safe failures,
 λ_{dd} = rate of detected dangerous failures,
 λ_{du} = rate of undetected dangerous failures

In practice, detected dangerous failure are dealt with by fault reaction functions

Safety integrity level SIL	High demand or continuous mode of operation (Probability of a dangerous failure per hour) PFHD
3	10^{-8} to $< 10^{-7}$
2	10^{-7} to $< 10^{-6}$
1	10^{-6} to $< 10^{-5}$

Machinery: Risk estimation and SIL assignment of EN IEC 62061

Given as an example in an informative Annex

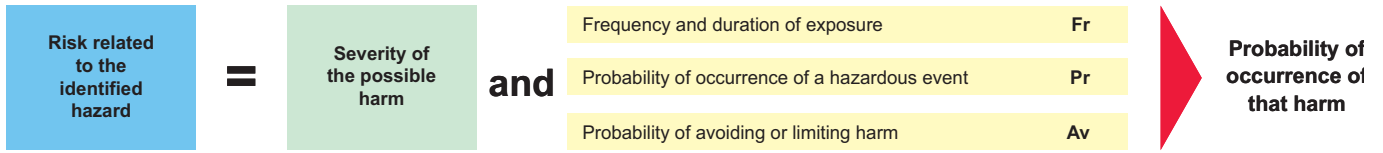

Machinery: Determination of the required SIL.

Example according to EN IEC 62061

Consequences	Severity (Se)
Irreversible: death, losing an eye or arm	4
Irreversible: broken limb(s), losing a finger(s)	3
Reversible: requiring attention from a medical practitioner	2
Reversible: requiring first aid	1

Frequency and duration of exposure (Fr)	
Frequency of exposure	Duration > 10 min
1 h	5
> 1 h to 1 day	5
> 1 day to 2 weeks	4
> 2 weeks to 1 year	3
> 1 year	2

Probability of occurrence	Probability (Pr)
Very high	5
Likely	4
Possible	3
Rarely	2
Negligible	1

Probability of a voiding or limiting harm (Av)	
Impossible	5
Rarely	3
Probable	1

Serial no.	Hazard	Se	Fr	Pr	Av	CI
1	Hazard x	4	5	4	3	12
2						

Risk assessment and safety measures

Product : _____
 Issued by : _____
 Date : _____

Black area = Safety measures required
 Grey area = Safety measures recommended

Consequences	(Se)	Class CI					Frequency and duration Fr	Probability of hzd. Event Pr	Avoidance Av	
		3-4	5-7	8-10	11-13	14-15			Av	Av
Death, losing an eye or arm	4	SIL2	SIL2	SIL2	SIL3	SIL3	<= 1 hour	Common	5	
Permanent, losing fingers	3		OM	SIL1	SIL2	SIL3	> 1 h to <= 1 day	Likely	4	
Reversible, medical attention	2			OM	SIL1	SIL2	> 1 day to <= 2 wks	Possible	3	Impossible
Reversible, first aid	1				OM	SIL1	> 2 wks to <= 1 year	Rarely	2	Possible
							> 1 year	Negligible	1	Likely

No.	Hazard	Se	Fr	Pr	Av	CI	Safety Measure	Safe

Comments

Safety of Machinery: *EN ISO 13849-1, definition of MTTF_d

■ The parameter for the failure rate in EN ISO 13849-1 is the Mean Time To Failure (MTTF). This time value indicates the number of years in which the first failure probably occurs.

- **MTTF = mean time to failure** [years]
 - The mean time after installation of devices to any first failure.
 - The general relation between λ and MTTF is:

$$MTTF = 1/\lambda$$

- **MTBF = mean time between failures**
 - Not relevant for devices which are not repaired.

- **MTTF_d = mean time to dangerous failure**
 - The MTTF_d is defined in EN ISO 13849-1 as the expectation of the mean time to dangerous failure of a safety related part of a control system.

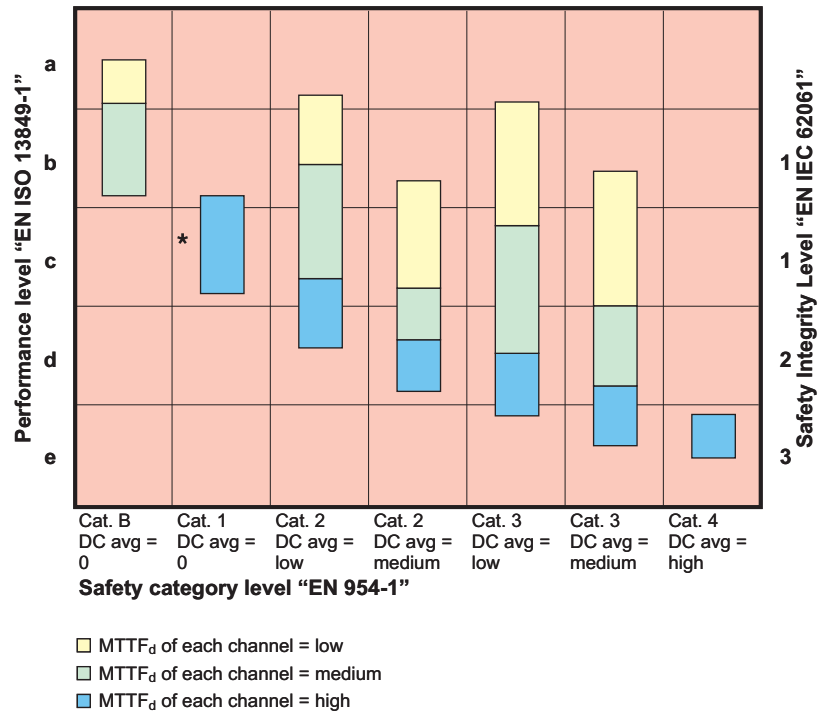

* In several application the realisation of performance level c by category 1 may not be sufficient. In this case a higher category e.g. 2 or 3 should be chosen.

Safety of Machinery: *EN ISO 13849-1 Risk graph and parameters

S = Severity of injury

- S1 = Slight (normally reversible injury)
- S2 = Serious (normally irreversible) injury including death

F = Frequency and/or exposure time to the hazard

- F1 = Seldom to less often and/or the exposure time is short
- F2 = Frequent to continuous and/or the exposure time is long

P = Possibility of avoiding the hazard or limiting the harm

- P1 = Possible under specific conditions
- P2 = Scarcely possible

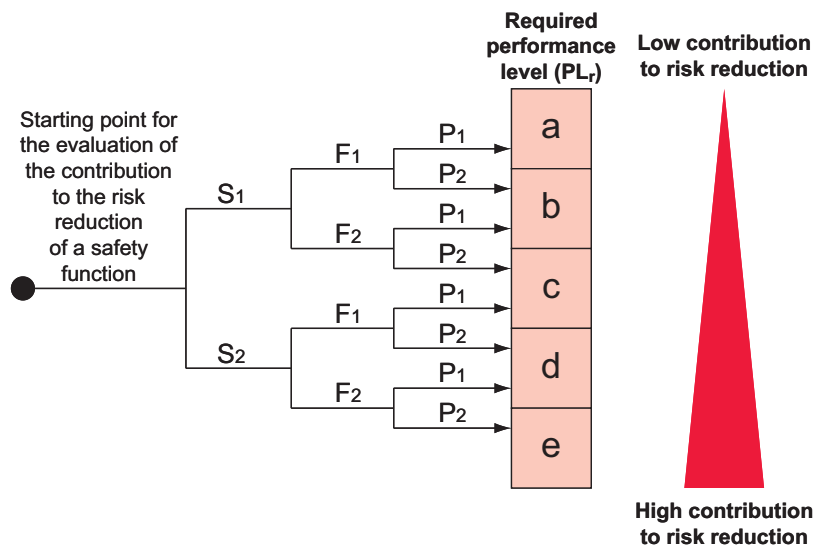

SafetySuite V2 software

SafetySuite V2 software incorporates 4 software applications for machine safety, it is available in 4 complete versions and 3 versions updated, adapted to your particular needs:



■ Protect Area Design

Safety light curtains and sensing mats configuration software.

SafetySuite V2 comprising Protect Area Design (full version) and demo versions of the 3 other software applications.

Reference: **SISCD104200**



■ ASI SWIN

AS-Interface safety monitor configuration software.

SafetySuite V2 comprising Protect Area Design and ASI SWIN (full versions) and demo versions of the other 2 software applications.

Reference: **ASISWIN2**

ASISWIN update version comprising the new ASISWIN 2+, only if the previous version of Safety Suite V1 with ASISWIN2 version 2.0.3 (ref: ASISWIN) have been already installed.

Reference: **SSVASISWINUP**



■ XPS MCWIN

XPS MC safety controllers configuration software.

SafetySuite V2 comprising Protect Area Design, ASI SWIN and XPS MCWIN (full versions) and demo version of XPS MFWIN.

Reference: **XPSMCWIN**

XPSMCWIN update version comprising the new XPSMCWIN 2.10, only if the previous version of Safety Suite V1 with XPSMCWIN version 2.0 (ref: XPSMCWIN) have been already installed.

Reference: **SSVXPSMCWINUP**



■ XPS MFWIN

XPS MF safety PLCs programming software.

SafetySuite V2 comprising Protect Area Design, ASI SWIN, XPS MCWIN and XPS MFWIN (full versions).

Reference: **SSV1XPSMFWIN**

XPSMFWIN update version comprising the new XPSMFWIN 4.1 build 6150, only if the previous version of Safety Suite V1 with XPSMFWIN version 4.1 (ref: SSV1XPSMFWIN) have been already installed.

Reference: **SSVXPSMFWINUP**

For all XPSMF PLCs

- Maximum category of the solution **Category 4**
(EN 954-1)
- Max performance level for the solution **PL e**
(EN ISO 13849-1)
- Max safety integrity level for the solution **SIL 3**
(EN IEC 62061)



Safety PLC type		Compact					
Number of inputs/outputs	Digital (configurable with XPSMFWIN software)	24					
	Pulsed (1)	2x4					
Memory capacity	Application	250 Kb					
	Data	250 Kb					
Supply		External 24 VDC supply (with separate protection conforming to IEC 61131-2)					
Communication	On Ethernet network with safe Ethernet protocol	Integrated (2xRJ45)	Integrated (2xRJ45)	Integrated (2xRJ45)	Integrated (2xRJ45)	Integrated (2xRJ45)	Integrated (2xRJ45)
	On Modbus TCP/IP	–	Integrated (2xRJ45)	–	Integrated (2xRJ45)	–	Integrated (2xRJ45)
	On Modbus (Serial link)	–	–	Integrated (1xRJ45)	Integrated (1xRJ45)	–	–
	On Profibus DP	–	–	–	–	Integrated (SUB-D9)	Integrated (SUB-D9)
Input/output connections		Removable screw terminal blocks or removable cage clamp terminal blocks coded with locating device					
References		XPSMF4000	XPSMF4002	XPSMF4020	XPSMF4022	XPSMF4040	XPSMF4042

(1) They outputs are not safety outputs.

Compact



Safety PLC type		Compact				
Number of inputs	Digital	20	20	24	24	24
	Analogue	–	–	8	8	8
	Counting	–	–	2	2	2
Number of outputs	Digital	8	8	8	8	8
	Analogue	–	–	–	–	–
	Relay	–	–	–	–	–
Memory capacity	Application	250 Kb				
	Data	250 Kb				
Supply		External 24 VDC supply (with separate protection conforming to IEC 61131-2)				
Communication	On Ethernet network (Modbus TCP/IP)	Integrated (4xRJ45)	Integrated (4xRJ45)	Integrated (4xRJ45)	Integrated (4xRJ45)	Integrated (4xRJ45)
	On Modbus (Serial link)	Integrated (SUB-D9)	–	–	Integrated (SUB-D9)	–
	On Profibus DP	–	–	–	–	Integrated (SUB-D9)
Input/output connections		Removable screw terminal blocks, coded with locating device				
References (2)		XPSMF3022	XPSMF31222	XPSMF3502	XPSMF3522	XPSMF3542

(2) Products referenced XPSMF30/MF31/MF35 are marked Himatrix F30, F31 and F35.

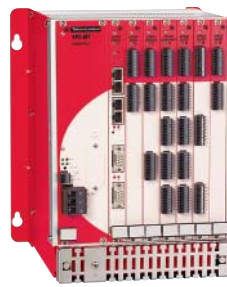

For all XPSMF PLCs

- Maximum category of the solution **Category 4**
(EN 954-1)
- Max performance level for the solution **PL e**
(EN ISO 13849-1)
- Max safety integrity level for the solution **SIL 3**
(EN IEC 62061)

Type		CPU	Power supply module	Rack with 6 slots	Software
Memory capacity	Application	500 Kb	–	–	For XPSMF PLCs
	Data	500 Kb	–	–	
Supply		–	External 24 VDC, integrated	–	
Communication	On Ethernet network (Modbus TCP/IP)	Integrated (4xRJ45)	–	–	Complete version
	On Modbus bus (Serial link)	Integrated (SUB-D9)	–	–	SSV1XPSMFWIN
Power connections		Screw terminal blocks	Screw terminal blocks	–	(1)
Dimensions W x D x H		–	–	257 x 239 x 310 mm	Update version
References		XPSMFCPU22	XPSMFP01	XPSMFGEH01	SSVXPSMFWINUP



I/O module type		For modular safety PLC						Relay
		Analogue		Digital				
Number of inputs	Digital	–	–	–	24	32	24	–
	Analogue	8	–	–	–	–	–	–
	Counting	–	–	2	–	–	–	–
Number of outputs	Digital	–	–	4	–	–	16	–
	Analogue	–	8	–	–	–	–	–
	Relay	–	–	–	–	–	–	8
Supply		Removable screw terminal blocks, coded with locating device						
References		XPSMFAI801	XPSMFAO801	XPSMFCIO2401	XPSMFDI2401	XPSMFDI3201	XPSMFDIO241601	XPSMFD0801

Decentralised safety I/O modules



Module type		Inputs/Ouputs Digital			
Number of inputs	Digital	16	8+2	16	20
Number of outputs	Digital	–	8	8	8
	Pulsed	4	2	2	–
Supply		External 24 VDC supply (with separate protection conforming to IEC 61131-2)			
Communication	On Safe Ethernet network (Modbus TCP/IP)	Integrated (2xRJ45)			
Input/output connections		Removable screw terminal blocks, coded with locating device			
References (2)		XPSMF1DIO1601	XPSMF3DIO8801	XPSMF3DIO16801	XPSMF3DIO20802



I/O module type		Inputs/Outputs Analogue	Outputs Digital		Relay	
Number of inputs	Analogue	8	–	–	–	
Number of outputs	Digital	–	4	16	–	
	Analogue (not safety)	4	–	–	–	
	Relay	–	–	–	8	16
Supply		External 24 VDC supply (with separate protection conforming to IEC 61131-2)				
Communication	On Safe Ethernet network (Modbus TCP/IP)	Integrated (2xRJ45)				
Input/output connections		Removable screw terminal blocks, coded with locating device				
References (2)		XPSMF3AIO8401	XPSMF2DO401	XPSMF2DO1601	XPSMF2DO801	XPSMF2DO1602

(1) To be ordered only if the previous version of have been already installed.

(2) Products referenced **XPSMF1/MF2/MF3** are marked **Himatrix F1, F2 and F3**.

For all XPSMC controllers

- Max performance level for the solution (EN ISO 13849-1) **PL e**
- Max safety integrity level for the solution (EN IEC 62061) **SIL 3**

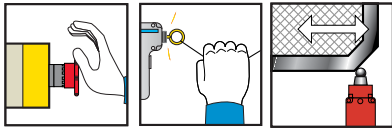

Maximum category of the solution (EN 954-1)		Category 4		
Number of circuits	Safety	2 x 2N/O + 6 solid-state		2 x 3N/O per function
	Additional	-		3 solid-state
Display (number of LEDs)		30		12
Width of housing		74 mm		45 mm
Communication interface		Modbus	Modbus, CANopen	Modbus, Profibus DP

Universal solutions: safety controllers (for monitoring several safety functions simultaneously)

Supply voltage	24 VDC	XPSMC32Z (1)(2)	XPSMC32ZC (1)(2)	XPSMC32ZP (1)(2)	XPSMP1123P (3)
----------------	--------	-----------------	------------------	------------------	----------------

coded magnetic switches enabling switch



Maximum category of the solution (EN 954-1)		Category 4		
For monitoring		magnetic switches and enabling switch		
Number of circuits	Safety	2 x 2N/O + 6 solid-state		2 x 3N/O per function
	Additional	-		3 solid-state
Display (number of LEDs)		30		12
Width of housing		74 mm		45 mm
Communication interface		Modbus	Modbus, CANopen	Modbus, Profibus DP

Universal solutions: safety controllers (for monitoring several safety functions simultaneously)

Supply voltage	24 VDC	XPSMC32Z (1)(2)	XPSMC32ZC (1)(2)	XPSMC32ZP (1)(2)	XPSMP1123P (3)
----------------	--------	-----------------	------------------	------------------	----------------

safety mats and edging



Maximum category of the solution (EN 954-1)		Category 3		
Number of circuits	Safety	2 x 2N/O + 6 solid-state		2 x 3N/O per function
	Additional	-		3 solid-state
Display (number of LEDs)		30		12
Width of housing		74 mm		45 mm
Communication interface		Modbus	Modbus, CANopen	Modbus, Profibus DP

Universal solutions: safety controllers (for monitoring several safety functions simultaneously)

Supply voltage	24 VDC	XPSMC32Z (1)(2)	XPSMC32ZC (1)(2)	XPSMC32ZP (1)(2)	XPSMP1123P (3)
----------------	--------	-----------------	------------------	------------------	----------------

(1) Version with 32 inputs. For version with 16 inputs, replace 32 in the reference by 16 (example: XPSMC32Z becomes XPSMC16Z).

(2) Configuration software XPSMCWIN (complete version) or SSVXPSMCWINUP (update version), connecting cable, adaptor and set of screw terminal plug-in connectors XPSMCTS16 and XPSMCTS32 or set of spring clip terminal plug-in connectors XPSMCTC16 and XPSMCTC32 to be ordered separately.

(3) For fixed connector version, delete the letter P from the end of the reference (example: XPSMP1123P becomes XPSMP1123).

Safety modules for monitoring emergency stops and limit switches

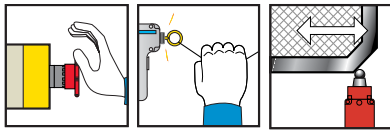

Maximum category of the solution (EN 954-1)		Category 3	Category 4				
Number of circuits	Safety	3N/O	3N/O	3N/O	7N/O	3N/O+3N/O time del.	2N/O+3N/O time del.
	Additional	1 solid-state	–	1N/C + 4 solid-state	2N/C + 4 solid-state	3 solid-state	4 solid-state
Display (number of LEDs)		2	3	4	4	11	4
Width of housing		22.5 mm	22.5 mm	45 mm	90 mm	45 mm	45 mm

Optimum solutions: safety modules (for monitoring 1 safety function)

Supply voltage (1)	24 VDC	–	–	–	–	XPSAV11113P	–
	24 VAC/DC	XPSAC5121P	XPSAF5130P	XPSAK311144P	XPSAR311144P	–	XPSATE5110P
	230 VAC	–	–	–	–	–	XPSATE3710P

(1) For version with non removable terminal block, delete the letter P from the end of the reference (example: XPSAV11113P becomes XPSAV11113).

coded magnetic switches enabling switch

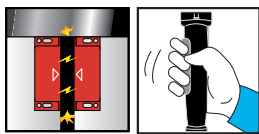

Maximum category of the solution (EN 954-1)		Category 4		
For monitoring		2 coded magnetic switches maximum	6 coded magnetic switches maximum	enabling switch
Number of circuits	Safety	2N/O	2N/O	2N/O
	Additional	2 solid-state	2 solid-state	2 solid-state
Display (number of LEDs)		3	15	3
Width of housing		22.5 mm	45 mm	22.5 mm

Optimum solutions: safety modules (for monitoring 1 safety function)

Supply voltage	24 VDC	XPSDMB1132P (1)	XPSDME1132P (1)	XPSVC1132P (1)
----------------	--------	-----------------	-----------------	----------------

(1) For version with non removable terminal block, delete the letter P from the end of the reference (example: XPSDMB1132P becomes XPSDMB1132).

safety mats and edging



Maximum category of the solution (EN 954-1)		Category 3
Number of circuits	Safety	3N/O
	Additional	1N/C + 4 solid-state
Display (number of LEDs)		4
Width of housing		45 mm

Optimum solutions: safety modules (for monitoring 1 safety function)

Supply voltage	24 VAC/DC	XPSAK311144P (1)
----------------	-----------	------------------

(1) For version with non removable terminal block, delete the letter P from the end of the reference (example: XPSAK311144P becomes XPSAK311144).

Preventa

Automation

Safety controllers for monitoring two-hand control

For all XPSMC controllers

- Max performance level for the solution (EN ISO 13849-1) **PL e**
- Max safety integrity level for the solution (EN IEC 62061) **SIL 3**

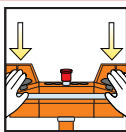

Universal



Maximum category of the solution (EN 954-1)		Category 4		
Number of circuits	Safety	2 x 2N/O + 6 solid-state		
	Additional	-		
Display (number of LEDs)		30		
Width of housing		74 mm		
Communication interface		Modbus	Modbus, CANopen	Modbus, Profibus DP

Universal solutions: safety controllers (for monitoring several safety functions simultaneously)

Supply voltage	24 VDC	XPSMC32Z (1)(2)	XPSMC32ZC (1)(2)	XPSMC32ZP (1)(2)
----------------	--------	-----------------	------------------	------------------

light curtains

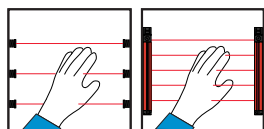

Universal



Maximum category of the solution (EN 954-1)		Category 4			2 light curtains monitoring max.
Number of circuits	Safety	2 x 2N/O + 6 solid-state	2x3N/O per function	6 PNP solid-state	
	Additional	-	3 solid-state	1 PNP + 1 NPN	
Display (number of LEDs)		30	12	14 + double display units	
Width of housing		74 mm	45 mm	100 mm	
Integral Muting function		Yes	No	Yes	
Communication interface		Modbus	Modbus, CANopen	Modbus, Profibus DP	-

Universal solutions: safety controllers (for monitoring several safety functions simultaneously)

Supply voltage	24 VDC	XPSMC32Z(1)(2)	XPSMC32ZC(1)(2)	XPSMC32ZP(1)(2)	XPSMP11123P (3)	XPSLCM1150 (4)
----------------	--------	----------------	-----------------	-----------------	-----------------	----------------

(1) Version with 32 inputs, for version with 16 inputs, replace 32 in the reference by 16 (example: XPSMC32Z becomes XPSMC16Z).

(3) For version with non removable terminal block, delete the letter P from the end of the reference (example: XPSMP11123P becomes XPSMP11123).

(4) Removable terminal blocks

zero speed, time delay

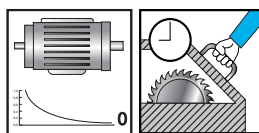

Universal



Maximum category of the solution (EN 954-1)		Category 4		
For monitoring		Motor zero speed condition		
Number of circuits	Safety	2 x 2N/O + 6 solid-state		
	Additional	-		
Display (number of LEDs)		30		
Width of housing		74 mm		
Communication interface		Modbus	Modbus, CANopen	Modbus, Profibus DP

Universal solutions: safety controllers (for monitoring several safety functions simultaneously)

Supply voltage	24 VDC	XPSMC32Z (5) (2)	XPSMC32ZC (5) (2)	XPSMC32ZP (5) (2)
----------------	--------	------------------	-------------------	-------------------

(2) Configuration software XPSMCWIN (complete version) or SSVXPSMCWINUP (update version), connecting cable, adaptor and set of screw terminal plug-in connectors XPSMCTS16 and XPSMCTS32 or set of spring clip terminal plug-in connectors XPSMCTC16 and XPSMCTC32 to be ordered separately.

(5) Plug-in connector version only.

Safety modules for monitoring two-hand control

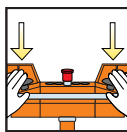

Maximum category of the solution (EN 954-1)		Category 1 (type IIIA to EN 574)	Category 4 (type IIIC to EN 574)	
Number of circuits	Safety	1N/O	2N/O	2N/O
	Additional	1N/C	1N/C	2 solid-state
Display (number of LEDs)		2	3	3
Width of housing		22.5 mm	45 mm	22.5 mm

Optimum solutions: safety modules (for monitoring 1 safety function)

Supply voltage	24 VDC	–	XPSBC1110	XPSBF1132P (1)
	24 VAC/DC	XPSBA5120	–	–

(1) For version with non removable terminal block, delete the letter P from the end of the reference (example: XPSBF1132P becomes XPSBF1132).

light curtains

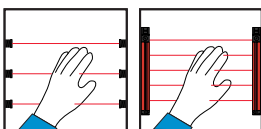

Maximum category of the solution (EN 954-1)		Category 2	Category 4		
Number of circuits	Safety	2N/O	3N/O	3N/O	7N/O
	Additional	4 solid-state	–	1N/C + 4 solid-state	1N/C + 4 solid-state
Display (number of LEDs)		4	3	4	4
Width of housing		45 mm	22.5 mm	45 mm	90 mm
Integral Muting function		Yes	No	No	No

Optimum solutions: safety modules (for monitoring 1 safety function)

Supply voltage	24 VDC	XPSCM1144P (1)	–	–	–
	24 VAC/DC	–	XPSAFL5130P (1)	XPSAK311144P (1)	XPSAR311144P (1)

(1) For version with non removable terminal block, delete the letter P from the end of the reference (example: XPSCM1144P becomes XPSCM1144).

zero speed, time delay and lifts

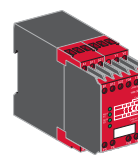
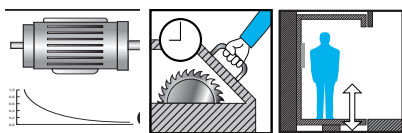

Maximum category of the solution (EN 954-1)		Category 3		Category 4
For monitoring		Motor zero speed condition	Safety time delay	
Number of circuits	Safety	1N/O + 1N/C	1N/O time delay	1N/O pulse
	Additional	2 solid-state	2N/C + 2 solid-state	2N/C + 2 solid-state
Display (number of LEDs)		4	4	4
Width of housing		45 mm	45 mm	45 mm

Optimum solutions: safety modules (for monitoring 1 safety function)

Supply voltage	24 VDC	XPSVNE1142P (1)	–	–	–
	24 VAC/DC	–	XPSTSA5142P (2)	XPSTSW5142P (2)	XPSDA5142

(1) Motor frequency ≤ 60 Hz.. For frequencies ≥ 60 Hz, please refer to the "Safety solution" catalogue.

(2) Removable terminal block version only.

For all ASISAFEMON monitors

- Max performance level for the solution **PL e**
(EN ISO 13849-1)
- Max safety integrity level for the solution **SIL 3**
(EN IEC 62061)

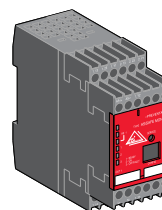
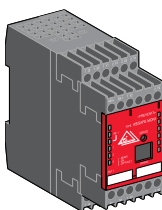

Maximum category of the solution (EN 954-1)		Category 4	
Number of circuits	Safety	2N/O	2 x 2N/O
	Auxiliary	1 solid-state	2 solid-state
Display (number of LEDs)		5	8
Width of housing		45 mm	45 mm
AS-Interface profile		S.7.F	S.7.F
Master module compatibility		V1 / V2.1	V1 / V2.1
References of monitor with	enhanced functions	ASISAFEMON1B	ASISAFEMON2B
	standard functions	ASISAFEMON1	ASISAFEMON2

Configuration software, adjustment terminal and AS-Interface analyser

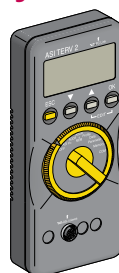
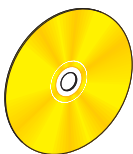

Type	"Safety Suite" configuration software (1)	Adjustment terminal (2)	AS-Interface Analyser
Multilingual	EN / FR / DE / ES / IT / PT	–	■ Analysis and diagnostics of AS-Interface line and Safety at Work
For use with	ASISAFEMON1/2, ASISAFEMON1B/2B	–	■ Complements the diagnostic functions of the local AS-Interface master
Media	CD-ROM PC	–	■ Maintenance or validation of AS-Interface lines
Environment	Windows	–	■ Print-out of AS-Interface line tests
Degree of protection	–	IP 20	
Supply	–	4 x LR6 batteries	
Dimensions W x D x H	–	70 x 50 x 170 mm	92 x 28 x 139 mm
References	Complete version	ASISWIN2	ASISA01
	Update version (3)	SSVASISWINUP	–

(1) CD-ROM with hardware and software user guides.

(2) For addressing safety interfaces, use the infrared adaptor ASITERIR1 or the standard adaptor ASISAD1.

(3) To be ordered only if the previous version of have been already installed.

Accessories

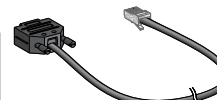
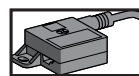

Type	Adaptor for the addressing of safety interfaces	Infrared adaptor for adjustment terminal	Tap-off for AS-Interface cable	Cable for monitor parametering, RS 232	Cable for monitor to monitor transfer
Degree of protection	IP 67	IP 67	IP 67	IP 20	IP 20
Cable length	–	1 m	2 m	2 m	0.2 m
References	ASISAD1	ASITERIR1	XZCG0122	ASISPCP	ASISCM

Safety interfaces

For Ø 22 Emergency stop



Interface type	For mushroom head pushbuttons				Control stations	
	Metal	(1)	Plastic	(1)	Plastic	
Degree of protection	IP 20	IP 20	IP 20	IP 20	IP 65	IP 65
Dimensions W x D x H (mm)	40 x 90 x 68	40 x 80 x 40	40 x 90 x 64	40 x 90 x 40	66 x 95 x 78	66 x 95 x 78
AS-Interface profile	S.O.B.F.F	S.O.B.F.F	S.O.B.F.F	S.O.B.F.F	S.O.B.F.F	S.O.B.F.F
Consumption from AS-Interface	45 mA	45 mA	45 mA	45 mA	45 mA	45 mA
Infrared addressing	Yes	No	Yes	No	No	No
Connection on AS-Interface	IDC (2)	Connector	IDC (2)	Connector	M12 connector	M12 connector
Reference with N/C + N/C contact (head not included)	ASISSLB4	ASISSE4	ASISSLB5	ASISSE5	ASISEA1C	ASISEK1C
Reference of head (Ø40 latching mushroom head, turn to release)	ZB4BS844 (3)	ZB4BS844 (3)	ZB4AS844 (3)	ZB5AS844 (3)	Integrated (4)	Integrated (5)

(1) For installation in enclosures.

(2) IDC: Insulation Displacement Connector.

(3) Head to be ordered separately. For other heads, please refer to www.schneider-electric.com.

(4) Turn to release latching mushroom head.

(5) Key release (n° 455) latching mushroom head.

For other safety products with M12 connector outputs or ISO M16/20



Type of entry	2 x M12 entries (5)	1 x M12 entry	1 x ISO M16 entry (6)
Degree of protection	IP 67	IP 67	IP 67
Dimensions W x D x H	40 x 40 x 58 mm	40 x 40 x 58 mm	40 x 40 x 57.5 mm
AS-Interface profile	S.O.B.F.F	S.O.B.F.F	S.O.B.F.F
Consumption from AS-Interface	45 mA	45 mA	45 mA
Infrared addressing	Yes	Yes	Yes
Connection on AS-Interface	IDC (1)	IDC (1)	IDC (1)
References	ASISSLC2	ASISSLC1	ASISLLS

(5) For connection using 2 pre-wired connectors, or 1 pre-wired connector + 1 connector.

(6) For 1 x ISO M20 entry, use adaptor shown below.

Accessories

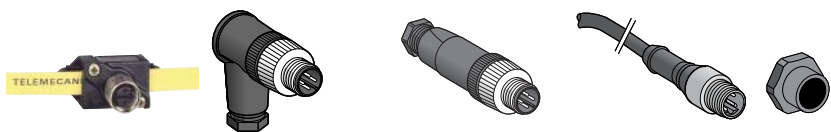

Type	Tap-off for AS-Interface cable	Connectors		Pre-wired connector	Adaptor (sold in lots of 5)
Description	M12 female, threaded	elbowed	straight	straight	ISO M16/M20
Degree of protection	IP 67	IP 67	IP 67	IP 67	IP 67
Length of cable	–	–	–	2 m	–
References	XZCG0120	XZCC12MCM40B	XZCC12MDM40B	XZCP1541L2	DE9RI2016

ISO entry (to EN 50262)

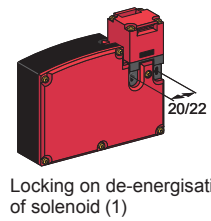
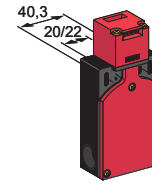
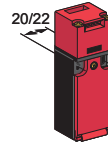
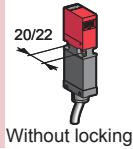
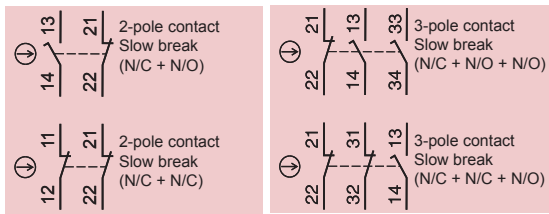

Plastic, double insulated switches	Type XCSMP pre-cabled, L = 2 m	Type XCSPA and TA 1xISO M16 entry. (2) 2xISO M16 entries. (2)		Type XCSTE 1 x ISO M16 cable entry (2)
Actuation speed (min → max)	0,05 m/s → 1,5 m/s	0,1 m/s → 0,5 m/s		0,1 m/s → 0,5 m/s
Degree of protection	IP 67	IP 67		IP 67
Rated operational characteristics (conforming to EN IEC 60947-5-1)	AC 15, C 300 / DC 13, Q 300	AC 15, A 300 / DC 13, Q 300		AC 15, B 300 / DC 13, Q 300
Dimensions (body + head) W x D x H	30 x 15 x 87 mm	30 x 30 x 93,5 mm	52 x 30 x 114,5 mm	110 x 33 x 93,5 mm
Solenoid supply voltage	-	-	-	24 VAC/DC
Complete switch	"N/C+N/O" stag. slow break	XCSMP59L2 (3) ⊕	XCSPA592 ⊕	XCSTE5312 ⊕
	"N/C+N/C" slow break	XCSMP79L2 (3) ⊕	XCSPA792 ⊕	XCSTE7312 ⊕
	"N/C+N/C+N/C" slow break	XCSMP70L2 (3) ⊕	XCSPA892 ⊕	XCSTA592 ⊕
	"N/C+N/C+N/C" snap action	-	-	-
	"N/C+N/C+N/C" slow break	XCSMP80L2 (3) ⊕	XCSPA992 ⊕	XCSTA792 ⊕
	"N/C+N/C+N/C" snap action	-	XCSPA492 ⊕	-

- (1) For locking on energisation of solenoid, please refer to www.schneider-electric.com.
- (2) With entry for n° 11 (Pg 11) cable gland, replace the last digit in the reference by 1 (example: XCSPA592 becomes XCSPA591).
- (3) For other models, please refer to www.schneider-electric.com.

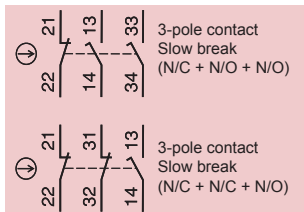

ISO entry (to EN 50262)

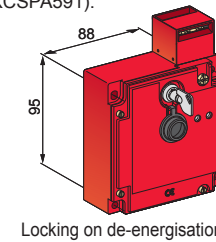
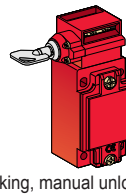
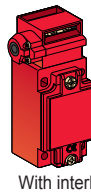
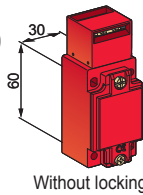

Metal switches	Type XCSA/B/C 1 x ISO M20 cable entry (2)			Type XCSE 2 x ISO M20 cable entries (2)		
Actuation speed (min → max)	0.1 m/s → 0.5 m/s			0.1 m/s → 0.5 m/s		
Degree of protection	IP 67			IP 67		
Rated operational characteristics (conforming to EN IEC 60947-5-1)	AC 15, A 300 / DC 13, Q 300			AC 15, B 300 / DC 13, Q 300		
Dimensions (body + head) W x D x H	40 x 44 x 113.5 mm	52 x 44 x 113.5 mm	52 x 44 x 113.5 mm	98 x 44 x 146 mm		
Solenoid supply voltage	-	-	-	24 VAC/DC	110/120 VAC/DC	220/240 VAC/DC
Complete switch	N/C + N/O + N/O slow break	XCSA502 ⊕	XCSB502 ⊕	XCSC502 ⊕	XCSE5312 ⊕	XCSE5332 ⊕
	N/C + N/C + N/O slow break	XCSA702 ⊕	XCSB702 ⊕	XCSC702 ⊕	XCSE7312 ⊕	XCSE7332 ⊕

- (1) For locking on energisation of solenoid, please refer to www.schneider-electric.com.
- (2) With entry for n° 13 (Pg 13.5) cable gland, replace the last digit in the reference by 1 (example: XCSA502 becomes XCSA501).

Accessories

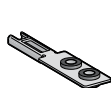

Straight actuator



Right-angled actuator



Pivoting actuator, RH door



Pivoting actuator, LH door

For safety switches XCSMP	Actuators			
References	XCSZ81	XCSZ84	XCSZ83	XCSZ85



Straight actuator



Wide actuator L=40 mm (1)



Right-angled actuator

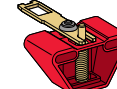

Pivoting actuator

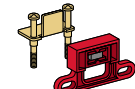

Guard/door retainer

References	Actuators				Retaining device
(1) For L = 29 mm, reference = XCSZ15.	XCSZ11	XCSZ12	XCSZ14	XCSZ13	XCSZ21

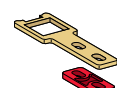

Straight actuator

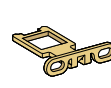

Wide actuator

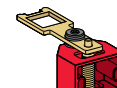

Pivoting actuator

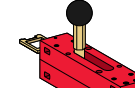

Door lock

For safety switches XCSA/B/C/E	Actuators			Door lock
References	XCSZ01	XCSZ02	XCSZ03	XCSZ05

Safety switches with rotary lever or spindle

ISO entry
(to EN 50262)

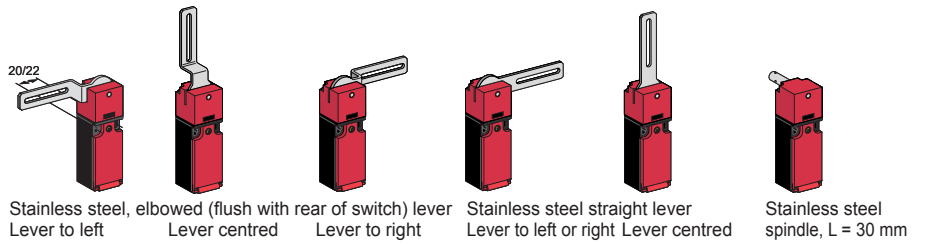
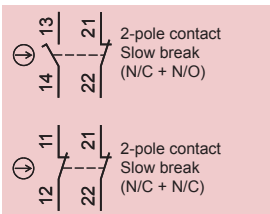

Plastic switches		Type XCSPL with rotary lever or XCSPR with spindle 1 x ISO M16 cable entry (1)				
Minimum torque (actuation / positive opening)		0,1 / 0,25 N.m				
Degree of protection		IP 67				
Rated operational characteristics		AC 15, A 300 / DC 13, Q 300 (selon EN IEC 60947-5-1)				
Dimensions (body + head) W x D x H		30 x 30 x 160 mm			30 x 30 x 96 mm	
Tripping angle		5°				
Complete switch	"N/C+N/O" stag. slow break	XCSPL592 (2) →	XCSPR582 (2) →	XCSPL572 (2) →	XCSPR562 (2) →	XCSPR552 (2) →
	"N/C+N/C" slow break	XCSPL791 (2) →	XCSPR781 (2) →	XCSPL771 (2) →	XCSPR762 (2) →	XCSPR752 (2) →
	"N/C+N/C+N/C" slow break	-	-	-	XCSPR862 (2) →	-
	"N/C+N/C+N/C" slow break	-	XCSPR981 (2) →	-	XCSPR962 (2) →	XCSPR952 (2) →

(1) With entry for n° 11 (Pg 11) cable gland, replace the last digit in the reference by 1 (example: XCSPL592 becomes XCSPL591).
 (2) For entry for ISO M20 cable gland, also order adaptor DE9RA1620 (sold in lots of 5).

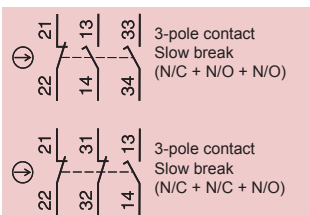

ISO entry
(to EN 50262)

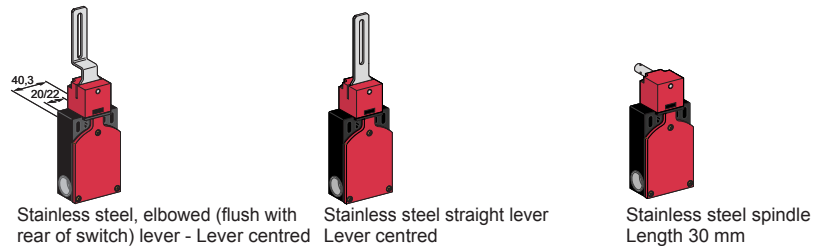

Plastic switches		Type XCSTL with rotary lever or XCSTR with spindle 2 x ISO M16 cable entries (1)		
Minimum torque (actuation / positive opening)		0.1 / 0.45 N.m		
Degree of protection		IP 67		
Rated operational characteristics		AC 15, A 300 / DC 13, Q 300 (conforming to EN IEC 60947-5-1)		
Dimensions (body + head) W x P x H		52 x 30 x 180 mm		52 x 30 x 117 mm
Tripping angle		5°		
Complete switch	N/C + N/O + N/O, 2 N/O staggered slow break	XCSTL582 (2) →	XCSTR552 (2) →	XCSTR552 (2) →
	N/C + N/C + N/O, N/O staggered slow break	XCSTL782 (2) →	XCSTR752 (2) →	XCSTR752 (2) →

(1) With entry for n° 11 (Pg 11) cable gland, replace the last digit in the reference by 1 (example: XCSTL582 becomes XCSTL581).

(1)

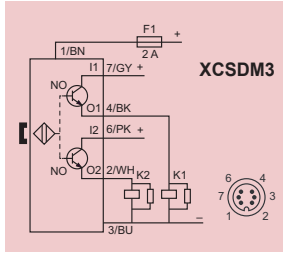

(1)

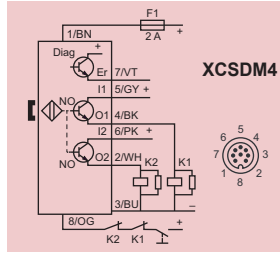

Type of system		SIL2/Category 3	SIL3/Category 4	
With integrated safety module		XCSDM3	XCSDM4	
Switches for actuation		Face to face, face to side, side to side		
Degree of protection		Pre-cabled: IP66 / IP67, IP69K, connector: IP67		
Type of contact		2 solid-state output PNP/NO, 1,5 A / 24VDC (2 A up to 60°C)		
Rated operational characteristics		U _b : 24 VDC +10% - 20%		
Dimensions W x D x H		34 x 27 x 100 mm		
Operating zone		Sao= 10 mm / Sar= 20 mm		
References	Connection	for cable L= 2m	XCSDM379102	XCSDM480102
		for cable L= 5m	XCSDM379105	XCSDM480105
		for cable L= 10m	XCSDM379110	XCSDM480110
		for connector M12	XCSDM3791M12	XCSDM4801M12

Coded magnetic

(1)

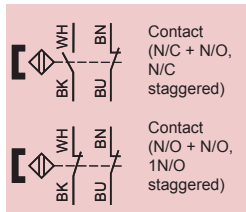

(1)

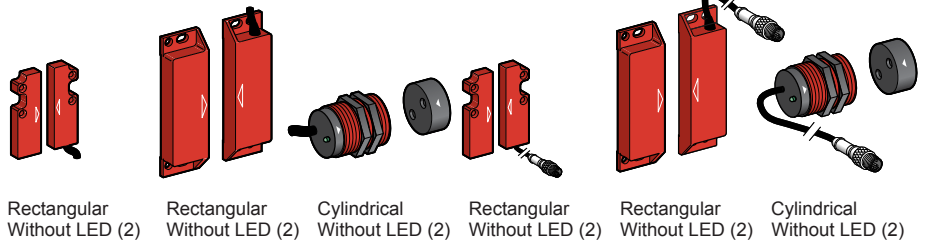
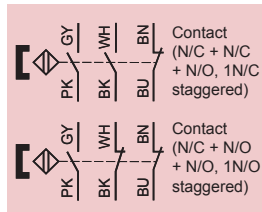

Plastic switches	Type XCSDM coded magnetic						
	Pre-cabled, L = 2 m			Connector on flying lead, L = 10 cm (3)			
Switches for actuation	Face to face, face to side, side to side			Face to face		Face to face, face to side, side to side	
Degree of protection	IP 66 + IP 67			IP 66 + IP 67			
Type of contact	REED			REED			
Rated operational characteristics	U _e = 24 VDC, I _e = 100 mA			U _e = 24 VDC, I _e = 100 mA			
Dimensions W x D x H	16 x 7 x 51 mm	25 x 13 x 88 mm	M30 x 38,5 mm	16 x 7 x 51 mm	25 x 13 x 88 mm	M30 x 38.5 mm	
Operating zone (4)	Sao = 5 / Sar = 15		Sao = 8 / Sar = 20	Sao = 5 / Sar = 15		Sao = 8 / Sar = 20	
Switch with coded magnet	N/C + N/O, N/C staggered	XCSDMC5902	XCSDMP5902	XCSDMR5902	XCSDMC590L01M8	XCSDMP590L01M12	XCSDMR590L01M12
	N/O + N/O, 1N/O staggered	XCSDMC7902	XCSDMR7902	XCSDMR7902	XCSDMC790L01M8	XCSDMP790L01M12	XCSDMR790L01M12
	N/C + N/C + N/O, 1N/C staggered	–	XCSDMP5002	–	–	XCSDMP500L01M12	–
	N/C + N/O + N/O, 1N/O staggered	–	XCSDMP7002	–	–	XCSDMP700L01M12	–

(1) NB. Contact states shown are with the magnet present.

(2) For version with LED indicator, replace the last 0 in the reference by 1 (example: XCSDMC5902 becomes XCSDMC5912).

(3) For associated pre-wired female connectors, please refer to the "Safety solution" catalogue.

(4) Sao: assured operating distance. Sar: assured release distance.

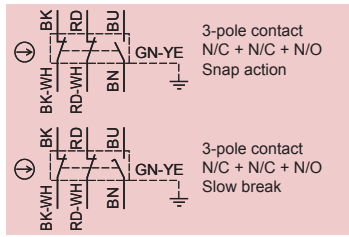

Metal end plunger



Roller plunger



Thermoplastic roller lever

Miniature switches	Type XCSM, metal pre-cabled, L = 1 m (1)		
Maximum actuation speed	0.5 m/s	0.5 m/s	1.5 m/s
Minimum force or torque (actuation / positive opening)	8.5 N / 42.5 N	7 N / 35 N	0.5 N.m / 0.1 N.m
Degree of protection	IP 66 + IP 67 + IP 68	IP 66 + IP 67 + IP 68	IP 66 + IP 67 + IP 68
Dimensions (body + head) W x D x H	30 x 16 x 60 mm	30 x 16 x 70.5 mm	30 x 32 x 92.5 mm
Complete switch	N/C + N/C + N/O snap action	XCSM3910L1 →	XCSM3902L1 →
	N/C + N/C + N/O slow break	XCSM3710L1 →	XCSM3702L1 →
			XCSM3915L1 →
			XCSM3715L1 →

(1) For a 2 m long cable, replace the last digit of the reference by 2 (example: XCSM3910L1 becomes XCSM3910L2).
For a 5 m long cable, replace the last digit of the reference by 5 (example: XCSM3910L1 becomes XCSM3910L5).

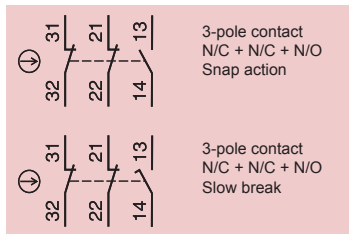

Metal end plunger



Roller plunger



Thermoplastic roller lever



Metal end plunger



Roller plunger



Thermoplastic roller lever

Compact switches	Type XCSD, metal 1 x ISO M20 x 1.5 cable entry (2)			Type XCSP, plastic 1 x ISO M20 x 1.5 cable entry (2)		
	Maximum actuation speed	0.5 m/s	1.5 m/s	1.5 m/s	0.5 m/s	1.5 m/s
Minimum force or torque (actuation / positive opening)	15 N / 45 N	12 N / 36 N	10 N.m / 0.1 N.m	15 N / 45 N	12 N / 36 N	10 N.m / 0.1 N.m
Degree of protection	IP 66 + IP 67			IP 66 + IP 67		
Dimensions (body + head) W x D x H (mm)	34 x 34.5 x 89	34 x 34.5 x 99.5	34 x 43 x 121.5	34 x 34.5 x 89	34 x 34.5 x 99.5	34 x 43 x 121.5
Complete switch	N/C + N/C + N/O snap action	XCSD3910P20	XCSD3902P20	XCSD3918P20	XCSP3910P20	XCSP3902P20
	N/C + N/C + N/O slow break	XCSD3710P20	XCSD3702P20	XCSD3718P20	XCSP3710P20	XCSP3702P20
						XCSP3918P20
						XCSP3718P20

(2) For Pg 13.5 and 1/2" NPT cable entries, refer to www.schneider-electric.com.

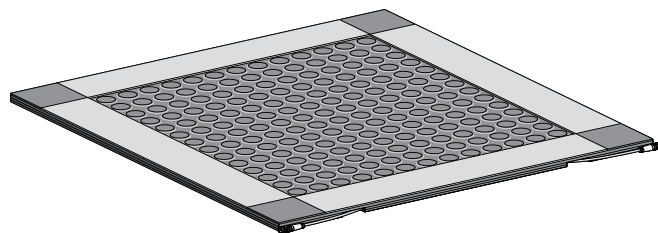

(1) For simplification of installation, see the "Protect Area design" software configuration tool. Reference: SISCD104200

Maximum category usage (EN 954-1)	Category 3			
Degree of protection	IP 67			
Response time (s)	Mat itself: 20 ms, with module: XPSAK ≤ 40 ms, XPSMP < 30 ms			
Sensitivity	Single mat > 20 kg / Group of mats > 35 kg			
Maximum load	2000 N/cm ²			
Connection (2)	By M8 jumper cable (1 male / 1 female), L = 100 mm			
Dimensions W x D x H	500 x 500 x 11 mm	500 x 750 x 11 mm	750 x 750 x 11 mm	750 x 1250 x 11 mm
References	XY2TP1	XY2TP2	XY2TP3	XY2TP4

(2) For associated jumper cable and pre-wired connector, please refer to www.schneider-electric.com

		Accessories								
Rails (set of 2)	Length	194 mm	394 mm	444 mm	494 mm	644 mm	694 mm	744 mm	1194 mm	1244 mm
References		XY2TZ10	XY2TZ20	XY2TZ30	XY2TZ40	XY2TZ50	XY2TZ60	XY2TZ70	XY2TZ80	XY2TZ90

Corners and rail connectors	External corners (set of 4)	Internal corner + external corner	Rail connectors, L = 56 mm with outlet for cable (set of 2)	Rail connectors, L = 6 mm (set of 2)
References	XY2TZ4	XY2TZ5	XY2TZ1	XY2TZ2

Light curtains

Type 2 conforming to IEC 61496-2



Light curtain functions

- Auto/Manual,
- Monitoring of external switching devices (EDM: External Devices Monitoring),
- LED display of operating modes

Type Slim range	Multi-beam, infrared transmission		
	Manual starting	Automatic starting	
Nominal sensing distance (Sn)	0.3...15 m		
Detection capacity	30 mm "hand"		
Number of safety circuits	2 solid-state PNP		
Response time (depending on model)	14...24 ms		
Connection	M12 Connector		
Height protected (mm)	150	XUSLNG5D0150	XUSLNG5C0150
	300	XUSLNG5D0300	XUSLNG5C0300
	450	XUSLNG5D0450	XUSLNG5C0450
	600	XUSLNG5D0600	XUSLNG5C0600
	750	XUSLNG5D0750	XUSLNG5C0750
	900	XUSLNG5D0900	XUSLNG5C0900
	1050	XUSLNG5D1050	XUSLNG5C1050
	1200	XUSLNG5D1200	XUSLNG5C1200
	1350	XUSLNG5D1350	XUSLNG5C1350
	1500	XUSLNG5D1500	XUSLNG5C1500

		Accessories		
Cable length		3 m	10 m	30 m
Pre-wired connector for XUSLN (screened cable)	For receiver	XSZNCR03	XSZNCR10	XSZNCR30
	For transmitter	XSZNCT03	XSZNCT10	XSZNCT30

Type 2 conforming to IEC 61496-1 et 2

Light curtain functions

- Auto/Manual,
- Monitoring of external switching devices (EDM: External Devices Monitoring),
- LED display of operating modes
- Integral muting function.



Type	Single-beam, infrared transmission		
Height protected (conforming to prEN 999)	750...1200 mm (1 to 4 beams)		
Nominal sensing distance (Sn)	8 m		
Number of circuits	Safety	2N/O	
	Additional	4 solid-state	
Response time	< 25 ms		
Modules (integral muting function)	24 VDC	XPSCM1144P (1)	
Thru-beam pairs, axially aligned	Pre-cabled, L = 5m	PNP	XU2S18PP340L5 (2)
	M12 connector	PNP	XU2S18PP340D (2)

(1) For version with non removable terminal block, delete the letter P from the end of the reference. Example: XPSCM1144P becomes XPSCM1144).

(2) For alignment at 90° to the mounting axes, insert the letter W in the reference before the last letter. Example: XU2S18PP340L5 becomes XU2S18PP340WL5).



Light curtain functions

- Auto/Manual/Manual 1st cycle
- Monitoring of external switching devices (EDM: External Devices Monitoring),
- Test input (MTS: Monitoring Test Signal),
- Blanking (ECS/B),
- Floating Blanking (FB),
- Blanking + Floating Blanking,
- Alignment aid by LED display of each light beam broken,
- LED display of operating modes and alarms.

Type		Multi-beam, infrared transmission		
Compact range				
Nominal sensing distance (Sn)		0.3...7.5 m	0.3...9 m	
Detection capacity		14 mm "finger"	30 mm "hand"	
Number of circuits	Safety	2 solid-state PNP	2 solid-state PNP	
	Auxiliary (alarm)	1 solid-state PNP	1 solid-state PNP	
Response time (depending on model)		20...40 ms	20...30 ms	
Connection		Flying lead with end M12 connector, L = 0.25 m		
Transmitter + receiver	Height protected (mm)	260	XUSLTQ6A0260	–
		350	XUSLTQ6A0350	XUSLTR5A0350
		435	XUSLTQ6A0435	–
		520	XUSLTQ6A0520	XUSLTR5A0520
		610	XUSLTQ6A0610	–
		700	XUSLTQ6A0700	XUSLTR5A0700
		870	XUSLTQ6A0870	XUSLTR5A0870
		955	XUSLTQ6A0955	–
		1045	XUSLTQ6A1045	XUSLTR5A1045
		1130	XUSLTQ6A1130	XUSLTR5A1130
		1215	XUSLTQ6A1215	XUSLTR5A1215
		1390	XUSLTQ6A1390	XUSLTR5A1390
		1570	–	XUSLTR5A1570
		1745	–	XUSLTR5A1745
1920	–	XUSLTR5A1920		
2095	–	XUSLTR5A2095		

Type 4 conforming to IEC 61496-2



Light curtain functions

- Auto/Manual/Manual 1st cycle
- Monitoring of external switching devices (EDM: External Devices Monitoring),
- Test input (MTS: Monitoring Test Signal),
- Alignment aid by LED display of each light beam broken,
- LED display of operating modes and alarms,
- Coding of the beams

Type			Single-beam and multi-beam, infrared transmission	
Compact range			Transmitter/receiver	Transmitter/passive receiver
Nominal sensing distance (Sn)			0.8...20 ou 70 m (according to config)	
Detection capacity			Body	
Number of circuits	Safety		2 solid-state PNP	
	Auxiliary (alarm or following)		1 solid-state PNP	
Response time (depending on model)			16...24 ms	
Connection			M12 Connector (1)	M12 Connector
Beam	Interval	Number		
	–	1	XUSLPZ1AM	–
	300 mm	4	XUSLPZ4A300M	–
		5	XUSLPZ5A300M	–
		6	XUSLPZ6A300M	–
	400 mm	3	XUSLPZ3A400M	–
	500 mm	2	XUSLPZ2A500M	XUSLPB2A500M
		3	XUSLPZ3A500M	–
	600 mm	2	XUSLPZ2A600M	XUSLPB2A600M

(1) Light curtain with M12 connector output, for terminal block output, replace **M** from the end of the reference by **B**. Example : XUSLPZ1AM becomes XUSLPZ1AB

			Accessories				
Cable length			3 m	5 m	10 m	15 m	30 m
Pre-wired connector for (screened cable)	XUSLT	For receiver	–	XSZTCR05	XSZTCR10	XSZTCR15	XSZTCR30
		For transmitter	–	XSZTCT05	XSZTCT10	XSZTCT15	XSZTCT30
	XUSLM	For receiver	XSZMCR03	–	XSZMCR10	–	XSZMCR30
		For transmitter	XSZMCT03	–	XSZMCT10	–	XSZMCT30
	XUSLP	For receiver	–	XSZPCR05	XSZPCR10	XSZPCR15	XSZPCR30
		For transmitter	–	XSZPCT05	XSZPCT10	XSZPCT15	XSZPCT30

Selection guidance software



		Protect Area Design (2)
For light curtains		XUSLT, XUSLM
Reference		SISCD104200

(2) "Protect Area Design" software is integrated in **SafetySuite V2**

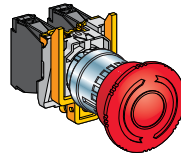
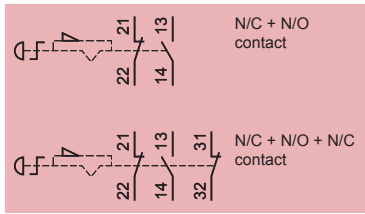

Turn to release

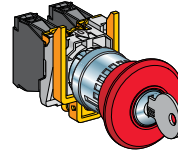

Key release
(key n° 455)

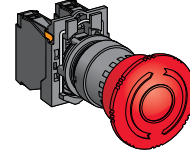

Turn to release

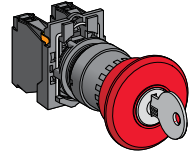

Key release
(key n° 455)

Pushbuttons	Metal		Plastic	
Mechanical life (millions of operating cycles)	0.3		0.3	
Shock / vibration resistance	10 gn / 5 gn		10 gn / 5 gn	
Degree of protection	IP 65		IP 65	
Rated operational characteristics	AC 15, A 600 / DC 13, Q 600 (conforming to EN IEC 60947-5-1)			
Dimensions Ø x Depth	Ø 40 x 82 mm	Ø 40 x 104 mm	Ø 40 x 81.5 mm	Ø 40 x 103 mm
Contact	N/C + N/O	XB4BS8445	XB5AS8445	XB5AS9445
	2 N/C + 1 N/O	XB4BS84441	-	ZB5AS944 + ZB5AZ141



Ø 22 trigger action latching pushbutton stations

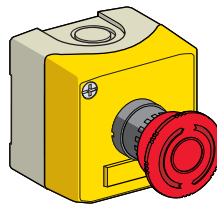
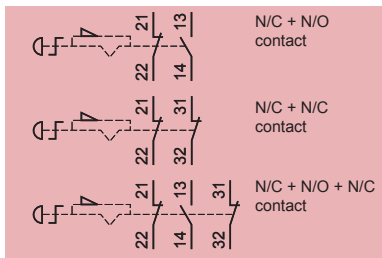

Turn to release

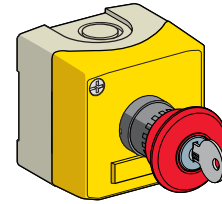

Key release (key n° 455)

Enclosure	Plastic	
	2 x ISO M20 cable entries or n° 13 (Pg 13.5) cable gland	
Mechanical life (millions of operating cycles)	0.1	0.1
Shock / vibration resistance	10 gn / 5 gn	10 gn / 5 gn
Degree of protection	IP 65	IP 65
Rated operational characteristics	AC 15, A 600 / DC 13, Q 600 (conforming to EN IEC 60947-5-1)	
Dimensions W x D x H	68 x 91 x 68 mm	68 x 113 x 68 mm
Contact	N/C + N/O	XALK178E
	N/C + N/C	XALK178F
	2 N/C + 1 N/O	-
		XALK188E
		XALK188F
		XALK188G

Accessories



With legend holder

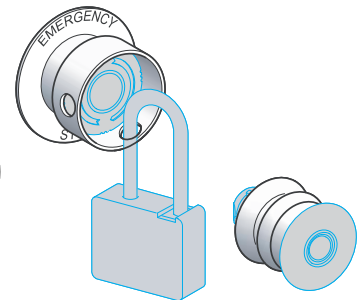
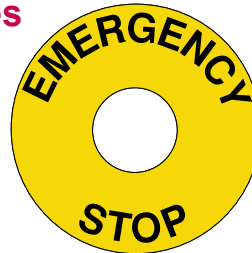

Type	Étiquettes		Padlocking kit	Bellows seals	
Colour	Red with white lettering		Yellow	Red Silicone	Black EPDM
Dimensions	30 x 40 mm (1)				
Références	Marking:	"Emergency stop"	ZBY2130	ZBY9130	-
		"Arrêt d'urgence"	ZBY2330	ZBY9330	-
		"Not Aus"	ZBY2230	ZBY9230	-
			-	-	ZBZ3605

(1) circular appearance

Emergency stops

Cable (tripwire) operated

ISO entry
(to EN 50262)

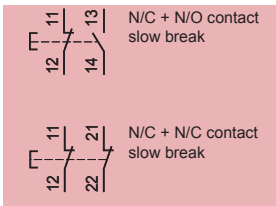

Booted pushbutton reset

Key release pushbutton reset (key n° 421)

For operating cable length ≤ 15 m	Latching, without indicator light		with indicator light
	1 x ISO M20 cable entry (1)		
Mechanical life (millions of operating cycles)	0.01		
Shock / vibration resistance	50 gn / 10 gn		
Degree of protection	IP 65		
Rated operational characteristics	AC-15, A300 / DC-13, Q300 (conforming to EN IEC 60947-5-1)		
Dimensions W x D x H	201 x 71 x 68 mm		
Operating cable length	≤ 15 m		
Operating cable anchoring point	To right or to left		
Contact	1 "N/C + N/O" slow break	XY2CH13250H29	XY2CH13450H29
	1 "N/C + N/C" slow break	XY2CH13270H29	XY2CH13470H29
			XY2CH13253
			XY2CH13273

(1) With entry for n° 13 (Pg 13.5) cable gland, delete H29 from the end of the reference (example: XY2-CH13250H29 becomes XY2-CH13250).

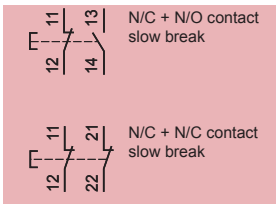

Booted pusbutton reset



Key release pushbutton reset (key n° 421)

For operating cable length ≤ 50 m	Latching, without indicator light			
	3 x ISO M20 cable entries or n° 13 (Pg 13.5) cable gland			
Mechanical life (millions of operating cycles)	0.01		0.01	
Shock / vibration resistance	50 gn / 10 gn		50 gn / 10 gn	
Degree of protection	IP 65		IP 65	
Rated operational characteristics	AC-15, A300 / DC-13, Q300 (conforming to EN IEC 60947-5-1)			
Dimensions W x D x H	229 x 82 x 142 mm		229 x 82 x 142 mm	
Operating cable length	≤ 50 m		≤ 50 m	
Operating cable anchoring point	To left	To right	To left	To right
Contact	1 "N/C + N/O" slow break	XY2CE2A250	XY2CE1A250	XY2CE2A450
	1 "N/C + N/C" slow break	XY2CE2A270	XY2CE1A270	XY2CE1A470
	2 "N/C + N/O" slow break	XY2CE2A290 (2)	XY2CE1A290 (2)	XY2CE2A490 (2)
				XY2CE1A290 (2)

(2) With 24V, 48 V, 130 V pilot lights, BA9S bulb not included, add 6 at the end of the reference. (example : XY2CE1A290 becomes XY2CE1A296).

With 230 V pilot lights, BA9S bulb included, add 7 at the end of the reference. (example : XY2CE1A290 becomes XY2CE1A297).

ISO entry
(to EN 50262)

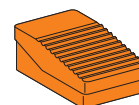
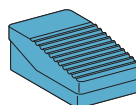
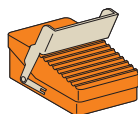

Type			Foot switches without protective cover			
			2 cable entries for n° 16 (Pg 16) cable gland (1)			
Trigger mechanism			With (positive operating action reqd.)		Without	
Colour			Orange	Blue	Orange	
Mechanical life (millions of operating cycles)			15			
Degree of protection			IP 66			
Shock resistance			100 joules			
Rated operational characteristics			AC 15, A 300 / DC 13, Q 300 (conforming to EN IEC 60947-5-1)			
Dimensions W x D x H			104 x 172 x 59 mm			
Contact operation	1 step	1 N/C + N/O	XPER810	XPEM110	XPER110	
		2 N/C + N/O	XPER811	XPEM111	XPER111	
Contact operation	2 step	2 N/C + N/O	XPER911	XPEM211	XPER211	
		Analogue output	2 N/C + N/O	XPER929	-	XPER229

(1) For entry for ISO M20 cable gland, also order adaptor DE9RA1620 (sold in lots of 5).

ISO entry
(to EN 50262)

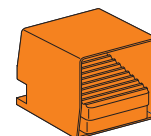
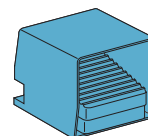
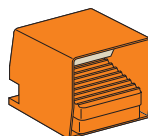
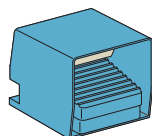

Type			Foot switches without protective cover			
			2 cable entries for n° 16 (Pg 16) cable gland (1)			
Trigger mechanism			With (positive operating action reqd.)		Without	
Colour			Blue	Orange	Blue	Orange
Mechanical life (millions of operating cycles)			15			
Degree of protection			IP 66			
Shock resistance			100 joules			
Rated operational characteristics			AC 15, A 300 / DC 13, Q 300 (conforming to EN IEC 60947-5-1)			
Dimensions W x D x H			160 x 186 x 152 mm			
Contact operation	1 step	1 N/C + N/O	XPEM510	XPER510	XPEM310	XPER310
		2 N/C + N/O	XPEM511	XPER511	XPEM311	XPER311
Contact operation	1 step latching	1 N/C + N/O	-	-	XPEM410	XPER410
		2 N/C + N/O	XPEM711	XPER711	XPEM611	XPER611
Contact operation	Analogue output	2 N/C + N/O	XPEM529	XPER529	XPEM329	-

(1) For entry for ISO M20 cable gland, also order adaptor DE9RA1620 (sold in lots of 5).

Double pedal switches

ISO entry
(to EN 50262)

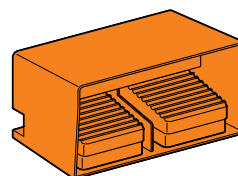
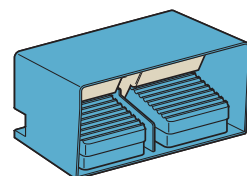

Type			Foot switches without protective cover			
			2 cable entries for n° 16 (Pg 16) cable gland (1)			
Trigger mechanism			With (positive operating action reqd.)		Without	
Colour			Blue	Orange	Blue	Orange
Mechanical life (millions of operating cycles)			15			
Degree of protection			IP 66			
Shock resistance			100 joules			
Rated operational characteristics			AC 15, A 300 / DC 13, Q 300 (conforming to EN IEC 60947-5-1)			
Dimensions W x D x H			295 x 190 x 155 mm			
Contact operation	1 step	2 x 1 N/C + N/O	XPEM5100D	XPER510D	XPEM3100D	XPER3100D
		2 x 2 N/C + N/O	XPEM5110D	XPER5110D	XPEM3110D	XPER3110D

(1) For entry for ISO M20 cable gland, also order adaptor DE9RA1620 (sold in lots of 5).

Foot switches - plastic

Single pedal switches

ISO entry
(to EN 50262)

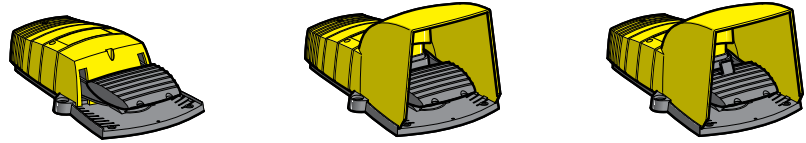

Type			Without protective cover		With protective cover	
			2 cable entries for ISO M20 cable gland			
Trigger mechanism			Without		With (positive operating action reqd.)	
Colour			Yellow		Yellow	
Mechanical life (millions of operating cycles)			5			
Degree of protection			IP 55			
Shock resistance			30 joules			
Rated operational characteristics			AC 15, A 300 / DC 13, Q 300 (conforming to EN IEC 60947-5-1)			
Dimensions W x D x H			160 x 280 x 70 mm		160 x 280 x 162 mm	
Contact operation	1 step	1 N/C + N/O	XPEY110	XPEY310	XPEY510	
		2 N/C + N/O	–	XPEY311	XPEY511	
	2 step	2 N/C + N/O	XPEY211	XPEY611	XPEY711	

ISO entry
(to EN 50262)

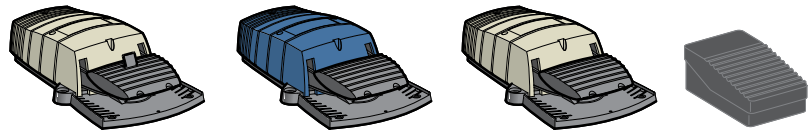

Type			Foot switches without protective cover			1 entry (1)
			2 cable entries for ISO M20 cable gland			1 entry (1)
Trigger mechanism			With (positive operating action reqd.)		Without	
Colour			Grey+		Blue Grey	
Mechanical life (millions of operating cycles)			10		2	
Degree of protection			IP 66		IP 43	
Shock resistance			100 joules			
Rated operational characteristics			AC 15, A 300 / DC 13, Q 300 (conforming to EN IEC 60947-5-1)			
Dimensions W x D x H			160 x 280 x 70 mm			94 x 161 x 54 mm
Contact operation	1 step	1 N/C + N/O	XPEG810	XPEB110	XPEG110	XPEA110
		2 N/C + N/O	–	XPEB111	XPEG111	XPEA111
	2 step	2 N/C + N/O	XPEG911	XPEB211	XPEG211	–

(1) Cable entry for ISO M16 or n° 9 (Pg 9) cable gland and for ISO M20 or n° 13 (Pg 13.5) cable gland.

ISO entry
(to EN 50262)

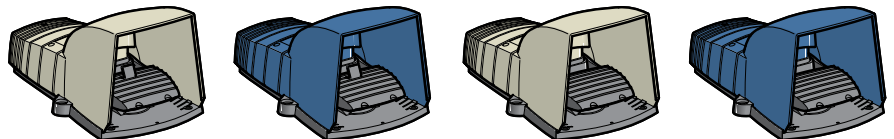

Type			Foot switches with protective cover			
			2 cable entries for ISO M20 cable gland			
Trigger mechanism			With (positive operating action reqd.)		Without	
Colour			Grey		Blue Grey	
Mechanical life (millions of operating cycles)			10			
Degree of protection			IP 66			
Shock resistance			100 joules			
Rated operational characteristics			AC 15, A 300 / DC 13, Q 300 (conforming to EN IEC 60947-5-1)			
Dimensions W x D x H			180 x 280 x 162 mm			
Contact operation	1 step	1 N/C + N/O	XPEG510	XPEB510	XPEG310	XPEB310
		2 N/C + N/O	XPEG511	XPEB511	XPEG311	XPEB311
	2 step	2 N/C + N/O	XPEG711	XPEB711	XPEG611	XPEB611

ISO entry
(to EN 50262)

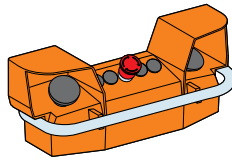

2 control pushbuttons and 1 mushroom head
Emergency stop or Lock out pushbutton

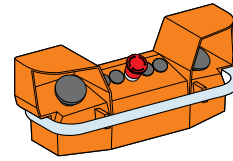

2 control pushbuttons and 1 mushroom head Emergency
stop or Lock out pushbutton, with pre-wired terminal block

Type	Two-hand control stations	
	2 cable entries for ISO M20 or n° 13 (Pg 13.5) cable gland, 1 cable entry for n° 21 (Pg 21) cable gland (2)	
Mechanical life (millions of operating cycles)	1	1
Degree of protection	IP 65	IP 65
Rated operational characteristics	AC 15, A 600 / DC 13, Q 600 (conforming to EN IEC 60947-5-1)	
Dimensions W x D x H	455 x 170 x 188.5 mm	
Red emergency stop (N/C + N/C slow break)	XY2SB71 (1)	XY2SB72 (1)
Yellow lock out (N/C + N/O break before make)	XY2SB75	XY2SB76

(1) To order a two-hand control station with pedestal XY2SB90, add 4 to the end of the reference (example: XY2SB71 becomes XY2SB714).

(2) For entry for ISO M25 cable gland, also order adaptor DE9RA2125 + fixing nut DE9EC21 (sold in lots of 5).

Enabling switch

Contact states

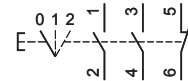
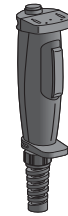
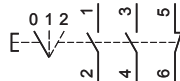
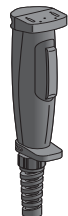
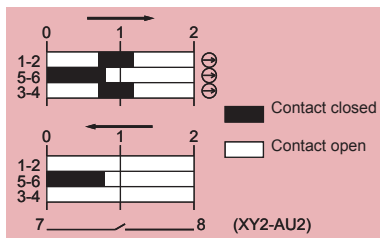

Type	Plastic grip	
	Entry for Ø 7 to 13 mm cable	
Number of contacts	3	3
Type of contacts	2 "NO" + 1 "NC"	2 "NO" + 1 "NC" 1 "NO" auxiliary
Description	3 positions	3 positions with button for N/O contact (auxiliary)
Shock / vibration resistance	10 gn / 6 gn	
Degree of protection	IP 66	IP 65
Rated operational characteristics	AC 15, C300 / DC 13, R300 (conforming to EN IEC 60947-5-1)	
Dimensions W x D x H	46 x 58 x 261 mm	46 x 58 x 269 mm
References	XY2AU1	XY2AU2

For fixing accessories, please refer to www.schneider-electric.com.

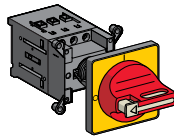
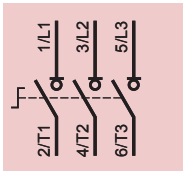

Door mounting

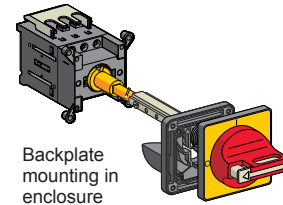

Backplate mounting in enclosure

Type	Mini-Vario for standard applications	
Front plate dimensions (mm)	60 x 60	60 x 60
Fixing	Ø 22.5 mm	Ø 22.5 mm
Degree of protection	IP 20	IP 20
Rated operational voltage (Ue)	690 V	690 V
Thermal current in open air (Ith)	12 A	VCDN12
	20 A	VCDN20

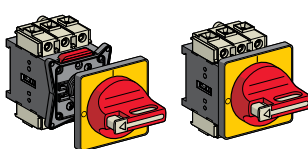
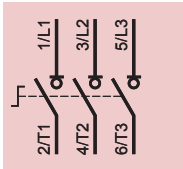

Door mounting

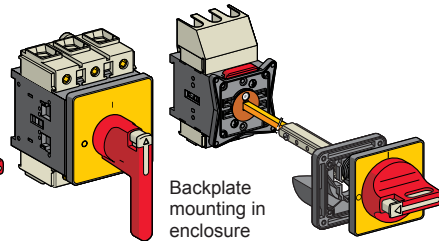

Backplate mounting in enclosure

Type	Vario for high performance applications					
Front plate dimensions (mm)	60 x 60	60 x 60	90 x 90	60 x 60	60 x 60	90 x 90
Fixing	Ø 22.5 mm	4 screws	4 screws	Ø 22.5 mm	4 screws	4 screws
Degree of protection	IP 20	IP 20	IP 20	IP 20	IP 20	IP 20
Rated operational voltage (Ue)	690 V	690 V	690 V	690 V	690 V	690 V
Thermal current in open air (Ith)	12 A	VCD02	VCF02	-	VCCD02	VCCF02
	20 A	VCD01	VCF01	-	VCCD01	VCCF01
	25 A	VCD0	VCF0	-	VCCD0	VCCF0
	32 A	VCD1	VCF1	-	VCCD1	VCCF1
	40 A	VCD2	VCF2	-	VCCD2	VCCF2
	63 A	-	VCF3	-	-	VCCF3
	80 A	-	VCF4	-	-	VCCF4
	125 A	-	-	VCF5	-	-
	175 A	-	-	VCF6	-	-

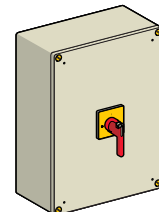
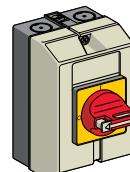
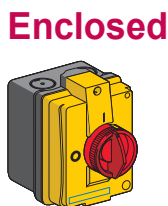
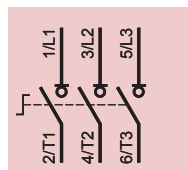

Type	Mini-Vario	Vario	
Front plate dimensions (mm)	60 x 60	60 x 60	90 x 90
Dimensions W x D x H	82.5 x 106 x 131 mm	90 x 131 x 146 mm	220 x 191 x 280 mm
Degree of protection	IP 55	IP 65	IP 65
Rated operational voltage (Ue)	690 V	690 V	690 V
Thermal current in enclosure (Ithe)	10 A	VCFN12GE	VCF02GE
	16 A	VCFN20GE	VCF01GE
	20 A	VCFN25GE	VCF0GE
	25 A	VCFN32GE	VCF1GE
	32 A	VCFN40GE	VCF2GE
	50 A	-	VCF3GE (1)
	63 A	-	VCF4GE (1)
	100 A	-	VCF5GE
	140 A	-	VCF6GE

(1) Dimensions W x D x H: 150 x 152 x 170 mm.

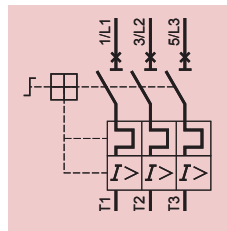

Complete circuit-breaker: circuit-breaker + enclosure + safety device.

Ex.: GV2ME01 + GV2MC02 + GV2K04.

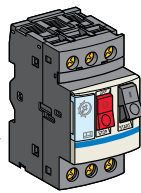

Type		Thermal-magnetic motor circuit-breakers				
Motor power	kW (on 400 V)	–	0.06	0.09	0.12...0.18	0.25...0.37
Setting range	A	0.1...0.16	0.16...0.25	0.25...0.40	0.40...0.63	0.63...1
Current I _d ± 20%	A	1.5	2.4	5	8	13
Current I _{the} (in enclosure)	A	0.16	0.25	0.40	0.63	1
Reference		GV2ME01	GV2ME02	GV2ME03	GV2ME04	GV2ME05
Motor power	kW (on 400 V)	0.37...0.55	0.75	1.1...1.5	2.2	3...4
Setting range	A	1...1.6	1.6...2.5	2.5...4	4...6.3	6...10
Current I _d ± 20%	A	22.5	33.5	51	78	138
Current I _{the} (in enclosure)	A	1.6	2.5	4	6.3	9
Reference		GV2ME06	GV2ME07	GV2ME08	GV2ME10	GV2ME14
Motor power	kW (on 400 V)	5.5	7.5	9...11	11	15
Setting range	A	9...14	13...18	17...23	20...25	24...32
Current I _d ± 20%	A	170	223	327	327	416
Current I _{the} (in enclosure)	A	13	17	21	23	24
Reference		GV2ME16	GV2ME20	GV2ME21	GV2ME22	GV2ME32

Enclosure

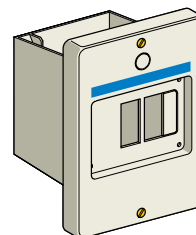
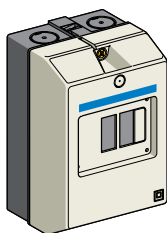

Type	Empty enclosure	
Mounting	Surface mounting	Flush mounting
Degree of protection	IP 55	IP 55 (front face)
Dimensions W x D x H (1)	93 x 145.5 x 147 mm	93 x 55 x 126 mm
References	GV2MC02	GV2MP02

(1) Dimensions with safety device GV2K04 fitted.

Safety device

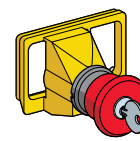
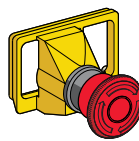
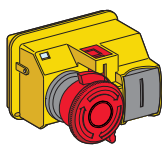

Type	Safety devices		
With red mushroom head	Turn to release Padlockable in "Off" position	Turn to release	Key release (key n° 455)
References	GV2K04	GV2K031	GV2K021

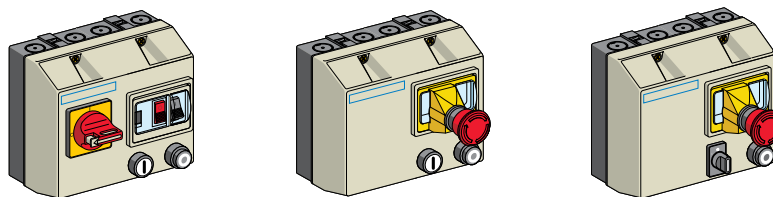

Type				Non reversing		Reversing
Degree of protection				IP 657		IP 657
Standard motor power ratings (kW), category AC3				Basic reference, to be completed by code indicating voltage (1)		
220/230 V	400/415 V	440 V	lth setting range (A)			
–	0.06	0.06	0.16...0.25	LG1K065..02	LG7K06..02	LG8K06..02
0.06	0.09	0.12	0.25...0.40	LG1K065..03	LG7K06..03	LG8K06..03
–	0.18	0.18	0.40...0.63	LG1K065..04	LG7K06..04	LG8K06..04
0.12	0.25	0.25	0.63...1	LG1K065..05	LG7K06..05	LG8K06..05
0.25	0.55	0.55	1...1.6	LG1K065..06	LG7K06..06	LG8K06..06
0.37	0.75	1.1	1.6...2.5	LG1K065..07	LG7K06..07	LG8K06..07
0.75	1.5	1.5	2.5...4	LG1K065..08	LG7K06..08	LG8K06..08
1.1	2.2	3	4...6.3	LG1K065..10	LG7K06..10	LG8K06..10
1.5	4	4	6...10	LG1K095..14	LG7K09..14	LG8K09..14
3	5.5	5.5	9...14	LG1D122..16	LG7D12..16	LG8K12..16
4	7.5	9	13...18	LG1D182..20	LG7D18..20	–
4	9	9	17...23	LG1D182..21	LG7D18..21	–

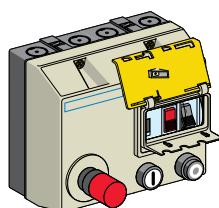

With integral control transformer, 400/24 V

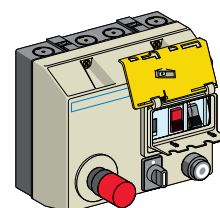

With integral control transformer, 400/24 V

Type		Non reversing		Reversing
Degree of protection		IP 657		IP 657
Standard motor power ratings (kW), category AC3		Basic references		
380/400 V	lth setting range (A)	(The code Q7 (380/400 V) designates the power supply voltage to which the starter will be connected)		
0.06	0.16...0.25	LJ7K06Q702	LJ8K06Q702	
0.09	0.25...0.40	LJ7K06Q703	LJ8K06Q703	
0.18	0.40...0.63	LJ7K06Q704	LJ8K06Q704	
0.25	0.63...1	LJ7K06Q705	LJ8K06Q705	
0.55	1...1.6	LJ7K06Q706	LJ8K06Q706	
0.75	1.6...2.5	LJ7K06Q707	LJ8K06Q707	
1.5	2.5...4	LJ7K06Q708	LJ8K06Q708	
2.2	4...6.3	LJ7K06Q710	LJ8K06Q710	
4	6...10	LJ7K09Q714	LJ8K09Q714	

Control circuit voltages available

Volts 50/60 Hz	24 V	230 V	400 V	415 V
(1) Voltage code	B7	P7	V7	N7

The control circuit must be cabled by the user.

X-ON Electronics

Largest Supplier of Electrical and Electronic Components

Click to view similar products for [Telemecanique manufacturer:](#)

Other Similar products are found below :

[9007CO54B2](#) [9007B3](#) [9007F4](#) [9007FA2](#) [AC118](#) [XCSL784B3](#) [XCSTE5513](#) [XZCP0266L5](#) [XZCPV1965L5](#) [ZCPED44](#) [XZCPV1041L5](#)
[XZCP29P12L2](#) [XUZASW006](#) [XUY40324](#) [XUX9APBNT16](#) [XUB4BPAWM12](#) [XCSPA793](#) [XCSB703](#) [SC300A500FP](#) [VM1NNO](#)
[XS7G12NA140](#) [ZCKE675](#) [XS506BSCAL01M12](#) [XUFZ920](#) [XCMD2110L5](#) [XMLG010D21](#) [XUM9ANCNM8](#) [XUBTAPSNM12](#)
[XU2S18PP340DR](#) [XCSPR553](#) [XCMN21F0L1](#) [ZCMD41L1](#) [9007C52G](#) [9007C54F](#) [XCSMP79L2](#) [XC1ZP4](#) [XU9M18MA230](#)
[XS7C4A1MPG13](#) [ZCKY31](#) [XCKP2545P16](#) [XUB9BPBNL2](#) [XCSDMP7005](#) [XCSDMP50010](#) [XS912R4PAM12](#) [XY2CE1A290](#)
[XMLP010BC71V](#) [XS8C4A1PCP20](#) [XCSD3719G13](#) [XS7C4A1DPG13](#) [XS1M12MA250](#)