

A High-capacity, High-dielectric-strength, Multi-pole Relay Used Like a Contactor



- Miniature hinge for maximum switching power for motor loads as well as resistive and inductive loads.
- No contact chattering for momentary voltage drops up to 50% of rated voltage.
- Withstanding more than 4 kV between contacts that are different in polarity and between the coil and contacts.
- Flame-resistant materials (UL94V-0-qualifying) used for all insulation material.
- Standard models approved by UL and CSA.



 Refer to *Safety Precautions for All Relays*.

Model Number Structure

Model Number Legend

G7J -  -  - 

1 2 3

1. Contact Form

4A: 4PST-NO
3A1B: 3PST-NO/SPST-NC
2A2B: DPST-NO/DPST-NC

2. Terminal Shape

P: PCB terminals
B: Screw terminals
T: Quick-connect terminals (#250 terminal)



3. Contact Structure

Z: Bifurcated contact
None: Single contact

Note: For bifurcated contact type, output is 1NO (4PST-NO) or 1NC (3PST-NO/SPST-NC).

Ordering Information

List of Models

Mounting type	Contact form	PCB terminals 	Screw terminals 	Quick-connect terminals 
PCB mounting	4PST-NO	G7J-4A-P, G7J-4A-PZ	---	---
	3PST-NO/SPST-NC	G7J-3A1B-P, G7J-3A1B-PZ	---	---
	DPST-NO/DPST-NC	G7J-2A2B-P	---	---
W-bracket (see note)	4PST-NO	---	G7J-4A-B	G7J-4A-T, G7J-4A-TZ
	3PST-NO/SPST-NC	---	G7J-3A1B-B, G7J-3A1B-BZ	G7J-3A1B-T, G7J-3A1B-TZ
	DPST-NO/DPST-NC	---	G7J-2A2B-B	G7J-2A2B-T

Note: These Relays need a W-bracket (sold separately) for mounting.
When ordering specify the voltage.
Example: G7J-4A-P 240 VAC
 Rated coil voltage

PCB Terminals

Contact form	Model	Rated voltage
4PST-NO	G7J-4A-P	24, 50, 100/120, 200/240 VAC 12, 24, 48, 100 VDC
3PST-NO/ SPST-NC	G7J-3A1B-P	24, 50, 100/120, 200/240 VAC 12, 24, 48, 100 VDC
DPST-NO/DPST- NC	G7J-2A2B-P	24, 50, 100/120, 200/240 VAC 12, 24, 48, 100 VDC

PCB Terminals (Bifurcated Contact)

Contact form	Model	Rated voltage
4PST-NO	G7J-4A-PZ	200/240 VAC 24 VDC
3PST-NO/ SPST-NC	G7J-3A1B-PZ	200/240 VAC 12, 24 VDC

W-bracket Screw Terminals

Contact form	Model	Rated voltage
4PST-NO	G7J-4A-B	24, 50, 100/120, 200/240 VAC 12, 24, 48, 100 VDC
3PST-NO/ SPST-NC	G7J-3A1B-B	24, 50, 100/120, 200/240 VAC 12, 24, 48, 100 VDC
DPST-NO/ DPST-NC	G7J-2A2B-B	24, 50, 100/120, 200/240 VAC 12, 24, 48, 100 VDC

■ Accessories (Order Separately)

Name	Model	Applicable Relay
W-bracket	R99-04 for G5F	G7J-4A-B G7J-3A1B-B(Z) G7J-2A2B-B G7J-4A-T(Z) G7J-3A1B-T G7J-2A2B-T

Application Examples

- Compressors for air conditioners and heater switching controllers.
- Switching controllers for power tools or motors.
- Lamp controls, motor drivers, and power supply switching controllers in copy machines, facsimile machines, and other office equipment.
- Power controllers for packers or food processing equipment.
- Power controllers for inverters.

Screw Terminals (Bifurcated Contact)

Contact form	Model	Rated voltage
3PST-NO/ SPST-NC	G7J-3A1B-BZ	200/240 VAC 12, 24 VDC

W-bracket Tab Terminals

Contact form	Model	Rated voltage
4PST-NO	G7J-4A-T	24, 50, 100/120, 200/240 VAC 12, 24, 48, 100 VDC
3PST-NO/ SPST-NC	G7J-3A1B-T	24, 50, 100/120, 200/240 VAC 12, 24, 48, 100 VDC
DPST-NO/ DPST-NC	G7J-2A2B-T	24, 50, 100/120, 200/240 VAC 12, 24, 48, 100 VDC

W-bracket Tab Terminals (Bifurcated Contact)

Contact form	Model	Rated voltage
4PST-NO	G7J-4A-TZ	200/240 VAC

Consult your OMRON representative for details on models not mentioned in this document.

Specifications

■ Coil Ratings

Rated voltage		Rated current	Coil resistance	Must-operate voltage	Must-release voltage	Max. voltage	Power consumption
AC	24 VAC	75 mA	---	75% max. of rated voltage	15% min. of rated voltage	110% of rated voltage	Approx. 1.8 to 2.6 VA
	50 VAC	36 mA	---				
	100 to 120 VAC	18 to 21.6 mA	---				
	200 to 240 VDC	9 to 10.8 mA	---				
DC	12 VDC	167 mA	72 Ω		10% min. of rated voltage		Approx. 2.0 W
	24 VDC	83 mA	288 Ω				
	48 VDC	42 mA	1,150 Ω				
	100 VDC	20 mA	5,000 Ω				

- Note:** 1. The rated current and coil resistance are measured at a coil temperature of 23°C with tolerances of +15%/–20% for AC rated current and ±15% for DC coil resistance. (The values given for AC rated current apply at 50 Hz or 60 Hz.)
 2. Performance characteristic data are measured at a coil temperature of 23°C.
 3. The maximum voltage is one that is applicable to the Relay coil at 23°C.

■ Contact Ratings

Item	Resistive load ($\cos \phi = 1$)	Inductive load ($\cos \phi = 0.4$)	Resistive load
Contact mechanism	Double break		
Contact material	Ag alloy		
Rated load	NO: 25 A at 220 VAC (24 A at 230 VAC) NC: 8 A at 220 VAC (7.5 A at 230 VAC)		NO: 25 A at 30 VDC NC: 8 A at 30 VDC
Rated carry current	NO: 25 A (1 A) NC: 8 A (1 A)		
Max. switching voltage	250 VAC		125 VDC
Max. switching current	NO: 25 A (1 A) NC: 8 A (1 A)		

Note: The values in parentheses indicate values for a bifurcated contact.

■ Characteristics

Contact resistance (see note 2)	50 mΩ max.
Operate time (see note 3)	50 ms max.
Release time (see note 3)	50 ms max.
Max. operating frequency	Mechanical: 1,800 operations/hr Electrical: 1,800 operations/hr
Insulation resistance (see note 4)	1,000 MΩ min. (at 500 VDC)
Dielectric strength	4,000 VAC, 50/60 Hz for 1 min between coil and contacts 4,000 VAC, 50/60 Hz for 1 min between contacts of different polarity 2,000 VAC, 50/60 Hz for 1 min between contacts of same polarity
Impulse withstand voltage	10,000 V between coil and contact (with 1.2 x 50 μs impulse wave)
Vibration resistance	Destruction: 10 to 55 to 10 Hz, 0.75-mm single amplitude (1.5-mm double amplitude) Malfunction: NO:10 to 55 to 10 Hz, 0.75-mm single amplitude (1.5-mm double amplitude) NC:10 to 26 to 10 Hz, 0.75-mm single amplitude (1.5-mm double amplitude)
Shock resistance	Destruction: 1,000 m/s ² Malfunction: NO:100 m/s ² NC:20 m/s ²
Endurance	Mechanical: 1,000,000 operations min. (at 1,800 operations/hr) Electrical: 100,000 operations min. (at 1,800 operations/hr) (see note 5)
Error rate (see note 6)	100 mA at 24 VDC (bifurcated contact: 24 VDC 10 mA)
Ambient temperature	Operating: –25°C to 60°C (with no icing or condensation)
Ambient humidity	Operating: 5% to 85%
Weight	PCB terminal: approx. 140 g Screw terminal: approx. 165 g Quick-connect terminal: approx. 140 g

- Note:**
1. The above values are all initial values.
 2. The contact resistance was measured with 1 A at 5 VDC using the voltage drop method.
 3. The operate and the release times were measured with the rated voltage imposed with any contact bounce ignored at an ambient temperature of 23°C.
 4. The insulation resistance was measured with a 500-VDC megger applied to the same places as those used for checking the dielectric strength.
 5. The electrical endurance was measured at an ambient temperature of 23°C.
 6. This value was measured at a switching frequency of 60 operations per minute.

■ Approved Standards

The G7J satisfies the following international standards. Approval for some international markings and symbols are still pending, however, and information on them will be added when they are approved.

UL (File No. E41643)

CSA (File No. LR35535)

Coil ratings	Contact ratings		Number of test operations
24 to 265 VAC 6 to 110 VDC	NO contact	25 A 277 VAC, Resistive	30,000
		25 A 120 VAC, General Use	
		25 A 277 VAC, General Use	
		25 A 240 VAC, General Use	100,000
		1.5 kW 120 VAC, Tungsten	6,000
		1.5 hp 120 VAC	1,000
		3 hp 240/265/277 VAC	30,000
		3-phase 3 hp 240/265/277 VAC	
		3-phase 5 hp 240/265/277 VAC	
		20FLA/120LRA 120 VAC	25,000
		17FLA/102LRA 277 VAC	
		TV-10 120 VAC	
		25 A 30 VDC, Resistive	30,000
		*1 A 277 VAC, General Use	6,000
	NC contact	8 A 277 VAC, Resistive	30,000
		8 A 120 VAC, General Use	
		8 A 277 VAC, General Use	
		8 A 30 VDC, Resistive	
		*1 A 277 VAC, General Use	6,000

Note: *These ratings are bifurcated contact ratings.

Reference

UL approval: UL508 for industrial control devices

CSA approval: CSA C22.2 No. 14 for industrial control devices

VDE (File No. 5381UG)

Model	Coil ratings	Contact ratings	
		NO contact	NC contact
G7J-4A-B(P) (T)	6, 12, 24, 48, 100 VDC	25 A 240 VAC $\cos\phi = 0.4$	8 A 240 VAC $\cos\phi = 0.4$
G7J-2A2B(P) (T)	24, 50, 100 to 120, 200 to 240 VAC	25 A 240 VAC $\cos\phi = 1$	8 A 240 VAC $\cos\phi = 1$
G7J-3A1B-B(P) (T)		25 A 30 VDC $L/R \geq 1$	8 A 30 VDC $L/R \geq 1$

Note: Add the suffix "-KM" to the model number when ordering.

Reference

VDE approval: EN60255-1-00: 1997

EN60255-23: 1996

KEMA (File No. 2001291.02)

Model	Coil ratings	Contact ratings
		NO contact
G7J-4A-B(P) (T) (Z) G7J-2A2B(P) (T)	200 to 240 VAC	Class AC1: 25 A at 220 VAC 11.5 A at 380 to 480 VAC
G7J-3A1B-B(P) (T) (Z)	6, 12, 24, 48, 100 VDC 24, 50, 100 to 120, 200 to 240 VAC	Class AC3: 11.5 A at 220 VAC and 8.5 A at 380 to 480 VAC *Class AC1: 1 A at 220 VAC

Note: Add the suffix "-KM" to the model number when ordering.

*This rating is the bifurcated contact rating.

Reference

KEMA approval: EN60947-4-1 for contacts

Engineering Data

■ **Maximum Switching Power**



■ **Endurance**

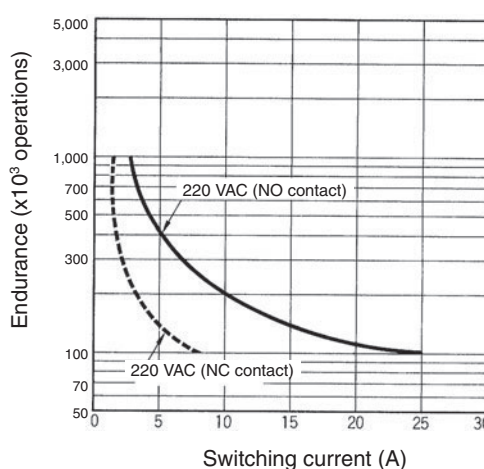

■ **Malfunctioning Shock**

G7J-2A2B



Number of samples: 5

Measurement conditions: Increase and decrease the specified shock gradually imposed in ±X, ±Y, and ±Z directions three times each with the Relay energized and not energized to check the shock values that cause the Relay to malfunction.

Criteria: There must not be any contact separation for 1 ms or greater with a shock of 100 m/s² imposed when the coil is energized or with a shock of 20 m/s² when the coil is not energized.

■ Ambient Temperature vs. Must-operate and Must-release Voltage

G7J 100 to 120 VAC

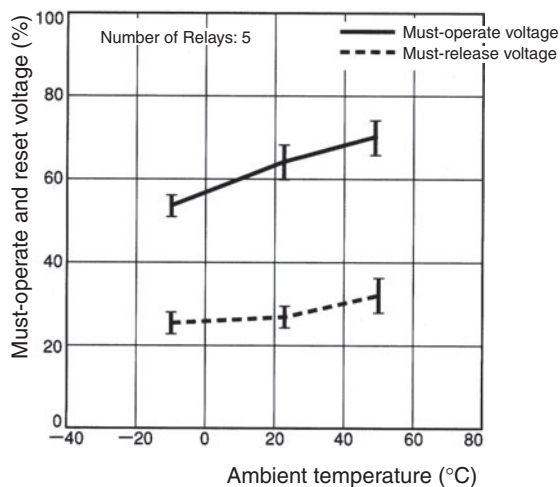

■ Ambient Temperature vs. Coil Temperature Rise

G7J-4A 100 to 120 VAC

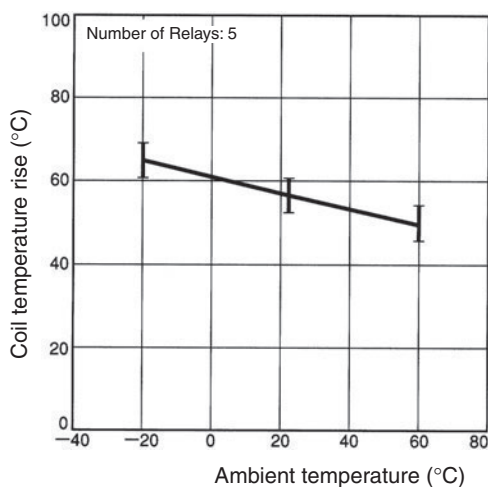

G7J 24 VDC

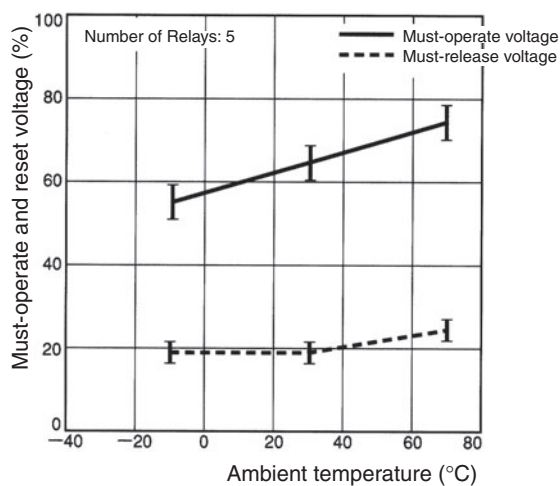

G7J-4A 24 VDC

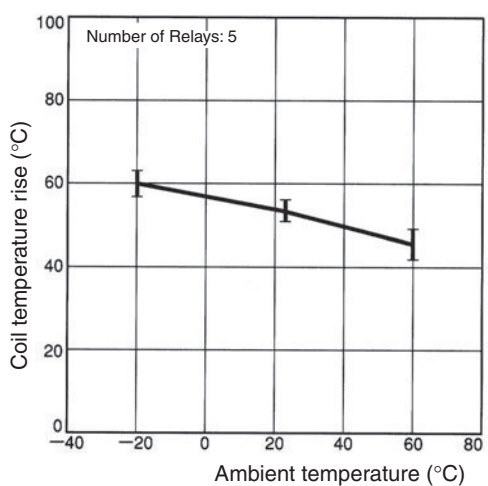

Motor Load

Item	G7J-4A-P, G7J-3A1B-P, G7J-4A-B, G7J-3A1B-B, G7J-4A-T, G7J-3A1B-T
Load	3φ, 220 VAC, 2.7 kW (with a inrush current of 78 A and a breaking current of 13 A)
Endurance	Electrical: 100,000 operations min.

Dimensions

Note: All units are in millimeters unless otherwise indicated.

Screw Terminals with W-bracket

G7J-4A-B, G7J-3A1B-B, G7J-3A1B-BZ, G7J-2A2B-B

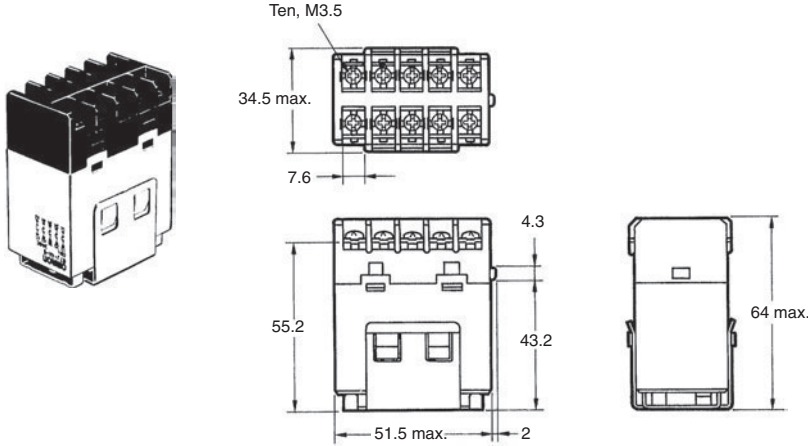

Mounting Holes

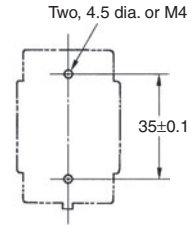

Quick-connect Terminals with W-bracket

G7J-4A-T, G7J-4A-TZ, G7J-3A1B-T, G7J-2A2B-T

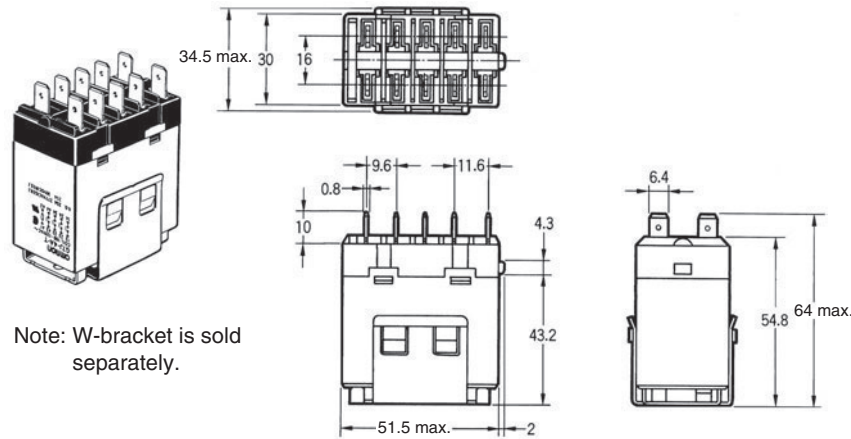

Mounting Holes

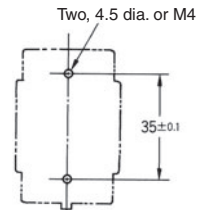

Note: W-bracket is sold separately.

PCB Terminals with PCB Mounting

G7J-4A-P, G7J-4A-PZ, G7J-3A1B-P, G7J-3A1B-PZ, G7J-2A2B-P

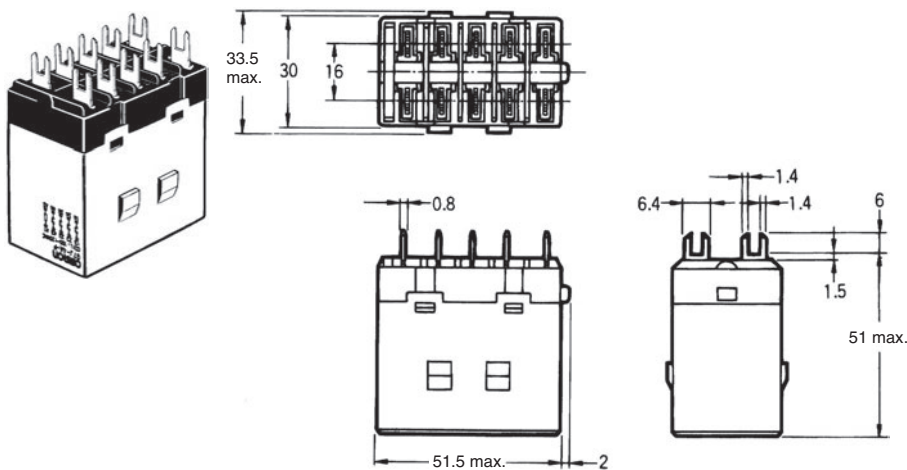

Mounting Dimensions

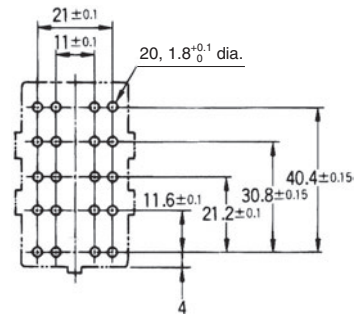

Terminal Arrangement/Internal Connections

G7J-4A-P
G7J-4A-B
G7J-4A-T



G7J-3A1B-P
G7J-3A1B-B
G7J-3A1B-T



The coil has no polarity.

G7J-2A2B-P
G7J-2A2B-B
G7J-2A2B-T



Note: Terminals 43 and 44 of the G7J-4A-P(T) and contacts 41 and 42 of the G7J-3A1B-P(B) are bifurcated contacts.

Accessories (Order Separately)

R99-04 W-bracket (for G5F)

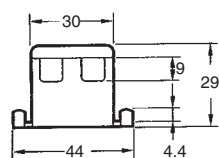

Mounting Holes



Safety Precautions

Refer to *Safety Precautions for All Relays*.

Correct Use

Installation

PCB Terminal-equipped Relays weigh approximately 140 g. Be sure that the PCB is strong enough to support them. We recommend dual-side through-hole PCBs to reduce solder cracking from heat stress.

Mount the G7J with its test button facing downwards. The Relay may malfunction due to shock if the test button faces upwards. Be careful not to press the test button by mistake because the contacts will go ON if the test button is pressed.

If the normal mounting direction is not used, carbides or powder from contact abrasion that results from load switching will accumulate inside the Relay. If the Relay is used past its endurance in this state, insulation failure between circuits of different polarity or Relay burning may occur.

Be sure to use the test button for test purposes only. The test button is used for Relay circuit tests, such as a circuit continuity test. Do not attempt to switch the load with the test button.

If a voltage is applied to the coil, the test button will retract in an ON state (i.e., an excited state).

Micro Loads

The G7J is used for switching power loads, such as motor, transformer, solenoid, lamp, and heater loads. Do not use the G7J for switching minute loads, such as signals. Use a Relay with a bifurcated contact construction for switching micro loads, in which case, however, only SPST-NO or SPST-NC output is obtained.

Soldering PCB Terminals

Be sure to solder the PCB terminals manually only. In the case of automatic soldering, some flux may stick to the test button and the G7J. As a result, the G7J may malfunction.

The G7J is not of enclosed construction. Therefore, do not wash the G7J with water or any detergent.

Connecting

Refer to the following diagram when connecting a wire with a screw terminal to the G7J.

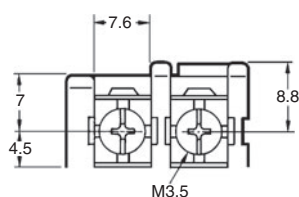

Allow suitable slack on leads when wiring, and do not subject the terminals to excessive force.

Tighten the terminal screws with torque 0.78 to 1.18 N·m. Loose screws result in disconnection of lead wire, malfunction or fire.

Faston Tabs

Do not impose excessive external force on the G7J in the horizontal or vertical directions when inserting the G7J to the Faston receptacle or pulling the G7J out from the Faston receptacle. Do not attempt to insert or pull out more than one G7J Unit together.

Do not solder the tab terminals.

Terminal	Receptacle	Housing
#250 terminal (6.35 mm in width)	AMP170333-1 (170327-1) AMP170334-1 (170328-1) AMP170335-1 (170329-1)	AMP172076-1: natural AMP172076-4: yellow AMP172076-5: green AMP172076-6: blue

Note: Numbers in parentheses are for air feed use.

Operating Coil

Internal Connections of Coils

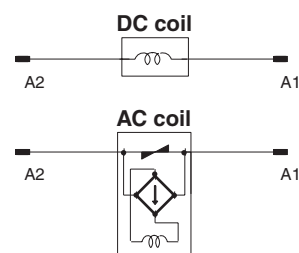

If a transistor drives the G7J, check the leakage current, and connect a bleeder resistor if necessary.

The AC coil is provided with a built-in full-wave rectifier. If a triac, such as an SSR, drives the G7J, the G7J may not release. Use the Power MOS FET Relay in this case.

ALL DIMENSIONS SHOWN ARE IN MILLIMETERS.

To convert millimeters into inches, multiply by 0.03937. To convert grams into ounces, multiply by 0.03527.

In the interest of product improvement, specifications are subject to change without notice.

Read and Understand This Catalog

Please read and understand this catalog before purchasing the products. Please consult your OMRON representative if you have any questions or comments.

Warranty and Limitations of Liability

WARRANTY

OMRON's exclusive warranty is that the products are free from defects in materials and workmanship for a period of one year (or other period if specified) from date of sale by OMRON.

OMRON MAKES NO WARRANTY OR REPRESENTATION, EXPRESS OR IMPLIED, REGARDING NON-INFRINGEMENT, MERCHANTABILITY, OR FITNESS FOR PARTICULAR PURPOSE OF THE PRODUCTS. ANY BUYER OR USER ACKNOWLEDGES THAT THE BUYER OR USER ALONE HAS DETERMINED THAT THE PRODUCTS WILL SUITABLY MEET THE REQUIREMENTS OF THEIR INTENDED USE. OMRON DISCLAIMS ALL OTHER WARRANTIES, EXPRESS OR IMPLIED.

LIMITATIONS OF LIABILITY

OMRON SHALL NOT BE RESPONSIBLE FOR SPECIAL, INDIRECT, OR CONSEQUENTIAL DAMAGES, LOSS OF PROFITS OR COMMERCIAL LOSS IN ANY WAY CONNECTED WITH THE PRODUCTS, WHETHER SUCH CLAIM IS BASED ON CONTRACT, WARRANTY, NEGLIGENCE, OR STRICT LIABILITY.

In no event shall the responsibility of OMRON for any act exceed the individual price of the product on which liability is asserted.

IN NO EVENT SHALL OMRON BE RESPONSIBLE FOR WARRANTY, REPAIR, OR OTHER CLAIMS REGARDING THE PRODUCTS UNLESS OMRON'S ANALYSIS CONFIRMS THAT THE PRODUCTS WERE PROPERLY HANDLED, STORED, INSTALLED, AND MAINTAINED AND NOT SUBJECT TO CONTAMINATION, ABUSE, MISUSE, OR INAPPROPRIATE MODIFICATION OR REPAIR.

Application Considerations

SUITABILITY FOR USE

OMRON shall not be responsible for conformity with any standards, codes, or regulations that apply to the combination of products in the customer's application or use of the products.

At the customer's request, OMRON will provide applicable third party certification documents identifying ratings and limitations of use that apply to the products. This information by itself is not sufficient for a complete determination of the suitability of the products in combination with the end product, machine, system, or other application or use.

The following are some examples of applications for which particular attention must be given. This is not intended to be an exhaustive list of all possible uses of the products, nor is it intended to imply that the uses listed may be suitable for the products:

- Outdoor use, uses involving potential chemical contamination or electrical interference, or conditions or uses not described in this catalog.
- Nuclear energy control systems, combustion systems, railroad systems, aviation systems, medical equipment, amusement machines, vehicles, safety equipment, and installations subject to separate industry or government regulations.
- Systems, machines, and equipment that could present a risk to life or property.

Please know and observe all prohibitions of use applicable to the products.

NEVER USE THE PRODUCTS FOR AN APPLICATION INVOLVING SERIOUS RISK TO LIFE OR PROPERTY WITHOUT ENSURING THAT THE SYSTEM AS A WHOLE HAS BEEN DESIGNED TO ADDRESS THE RISKS, AND THAT THE OMRON PRODUCTS ARE PROPERLY RATED AND INSTALLED FOR THE INTENDED USE WITHIN THE OVERALL EQUIPMENT OR SYSTEM.

PROGRAMMABLE PRODUCTS

OMRON shall not be responsible for the user's programming of a programmable product, or any consequence thereof.

Disclaimers

CHANGE IN SPECIFICATIONS

Product specifications and accessories may be changed at any time based on improvements and other reasons.

It is our practice to change model numbers when published ratings or features are changed, or when significant construction changes are made. However, some specifications of the products may be changed without any notice. When in doubt, special model numbers may be assigned to fix or establish key specifications for your application on your request. Please consult with your OMRON representative at any time to confirm actual specifications of purchased products.

DIMENSIONS AND WEIGHTS

Dimensions and weights are nominal and are not to be used for manufacturing purposes, even when tolerances are shown.

PERFORMANCE DATA

Performance data given in this catalog is provided as a guide for the user in determining suitability and does not constitute a warranty. It may represent the result of OMRON's test conditions, and the users must correlate it to actual application requirements. Actual performance is subject to the OMRON Warranty and Limitations of Liability.

ERRORS AND OMISSIONS

The information in this document has been carefully checked and is believed to be accurate; however, no responsibility is assumed for clerical, typographical, or proofreading errors, or omissions.

2011.4

In the interest of product improvement, specifications are subject to change without notice.

OMRON Corporation
Industrial Automation Company

<http://www.ia.omron.com/>

(c)Copyright OMRON Corporation 2011 All Right Reserved.

X-ON Electronics

Largest Supplier of Electrical and Electronic Components

Click to view similar products for [General Purpose Relays](#) category:

Click to view products by [Omron](#) manufacturer:

Other Similar products are found below :

[APF30318](#) [JVN1AF-4.5V-F](#) [PCN-105D3MHZ](#) [5JO-10000S-SIL](#) [5JO-1000CD-SIL](#) [5JO-400CD-SIL](#) [LY2S-AC220/240](#) [LYQ20DC12](#)
[6031007G](#) [6131406HQ](#) [6-1393099-3](#) [6-1393099-8](#) [6-1393122-4](#) [6-1393123-2](#) [6-1393767-1](#) [6-1393843-7](#) [6-1415012-1](#) [6-1419102-2](#) [6-1423698-4](#) [6-1608051-6](#) [6-1608067-0](#) [6-1616170-6](#) [6-1616248-2](#) [6-1616282-3](#) [6-1616348-2](#) [6-1616350-1](#) [6-1616350-8](#) [6-1616358-7](#) [6-1616359-9](#) [6-1616360-9](#) [6-1616931-6](#) [6-1617039-1](#) [6-1617052-1](#) [6-1617090-2](#) [6-1617090-5](#) [6-1617347-5](#) [6-1617353-3](#) [6-1617801-8](#) [6-1617802-2](#) [6-1618107-9](#) [6-1618248-4](#) [M83536/1-027M](#) [CX-4014](#) [MAHC-5494](#) [MAVCD-5419-6](#) [703XCX-120A](#) [7-1393100-5](#) [7-1393111-7](#)
[7-1393144-5](#) [7-1393767-8](#)