



Typical Applications

The HMC933LP4E is ideal for:

- EW Receivers
- Military Radar
- Test Equipment
- Satellite Communications
- Beam Forming Modules

Features

- Wide Bandwidth: 18 - 24 GHz
- 470° Phase Shift
- Low Insertion Loss: 4.5 dB
- Low Phase Error: ± 10 deg Typ.
- Single Positive Voltage Control
- 24 Lead 4x4 mm QFN Package: 16 mm²

Functional Diagram

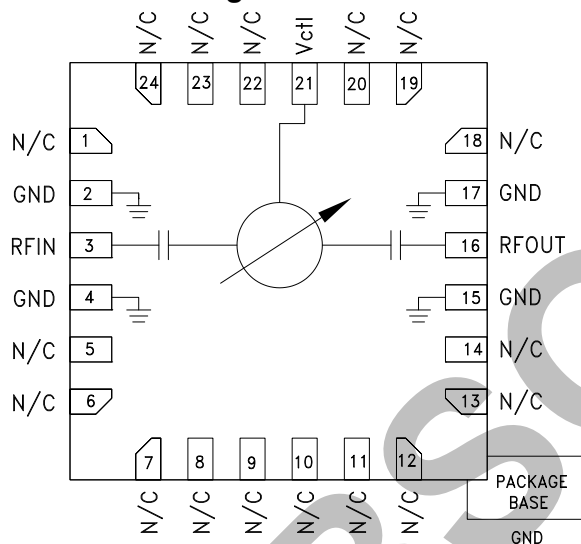

General Description

The HMC933LP4E is an Analog Phase Shifter which is controlled via an analog control voltage from 0 to +13V. The HMC933LP4E provides a continuously variable phase shift of 0 to 470 degrees from 18 to 24 GHz, with extremely consistent low insertion loss versus phase shift and frequency. The high accuracy HMC933LP4E is monotonic with respect to control voltage and features a typical low phase error of ± 10 degrees over a wide bandwidth. The HMC933LP4E is housed in an RoHS compliant 4x4 mm QFN leadless package.

Electrical Specifications, $T_A = +25^\circ\text{C}$, 50 Ohm System

Parameter	Min.	Typ.	Max.	Units
Frequency Range	18		24	GHz
Phase Shift Range		470		deg
Insertion Loss		4.5		dB
Return Loss (input and output)		14		dB
Control Voltage Range	0		13	V
Control Current Range			± 1	mA
Input IP3		33		dBm
Input Power @ -5° Shift In Insertion Phase ($V_{ctl} = 0V$)		11		dBm
Input Power @ -2° Shift In Insertion Phase ($V_{ctl} = 0.5V$)		12		dBm
Phase Voltage Sensitivity		34		deg/V
Phase Error (peak) *		+9 / -17		deg
Phase Error (average) *		+3 / -11		deg
Modulation Bandwidth		90		MHz
Insertion Phase Temperature Sensitivity		0.10		deg/°C

* Up to a phase shift range of 380 degrees.



**470° ANALOG PHASE SHIFTER,
18 - 24 GHz**

Insertion Loss vs. Frequency

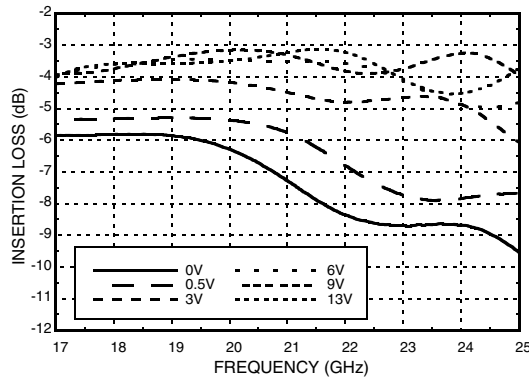

Insertion Loss vs. Vctl , F = 21 GHz

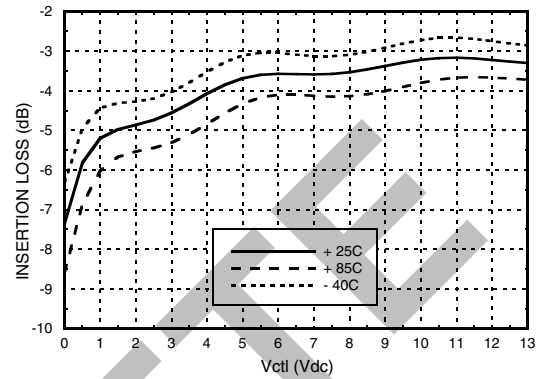

Phase Shift vs. Vctl

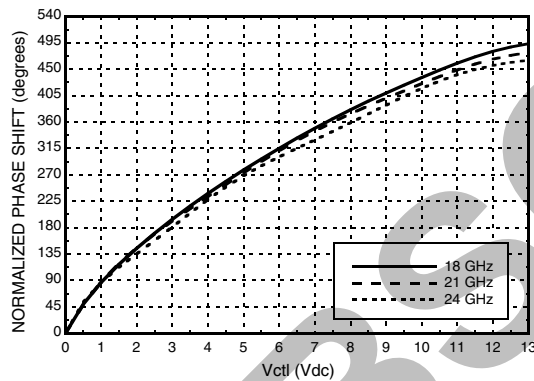

**Phase Shift vs. Frequency @ Vctl = 6V
(Relative to Vctl = 0V)**

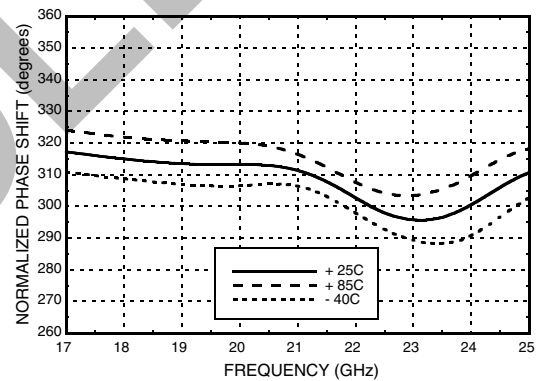

**Phase Shift vs. Frequency
(Relative to Vctl = 0V) Vctl = 0.5 to 13V**

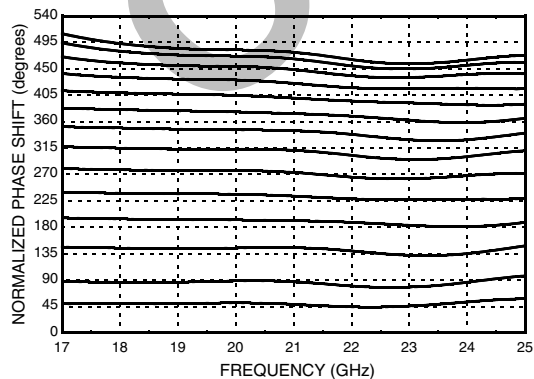

Phase Error vs. Frequency, Fmean = 21 GHz [1]

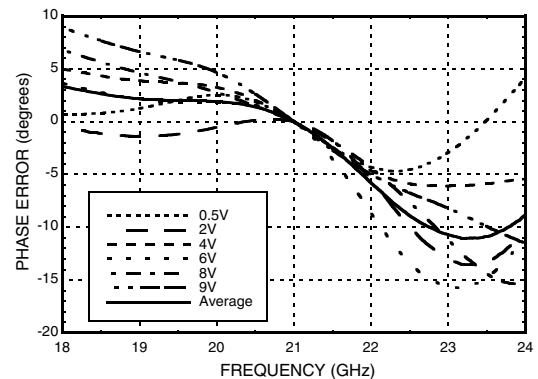

[1] 0 to 9V provides 0 - 380 degrees phase shift range



**470° ANALOG PHASE SHIFTER,
18 - 24 GHz**

Second Harmonics vs. Vctl, F = 21 GHz

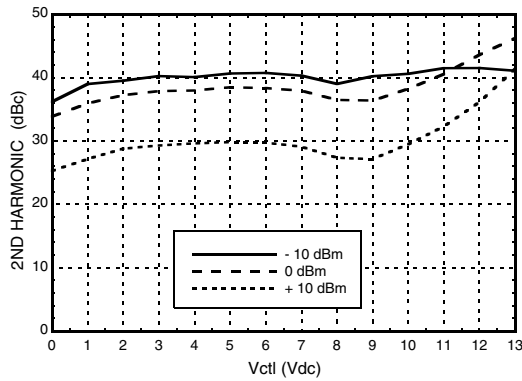

Input IP3 vs. Vctl, F = 21 GHz

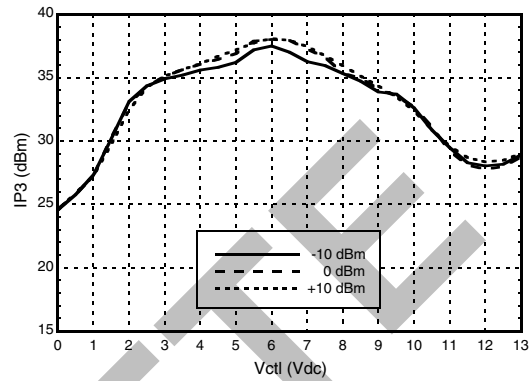

Insertion Loss vs. Pin @ 18 GHz

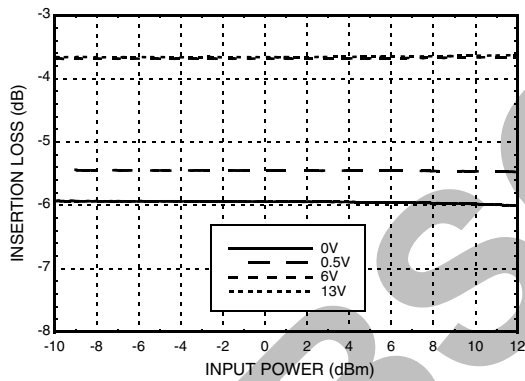

Insertion Loss vs. Pin @ 21 GHz

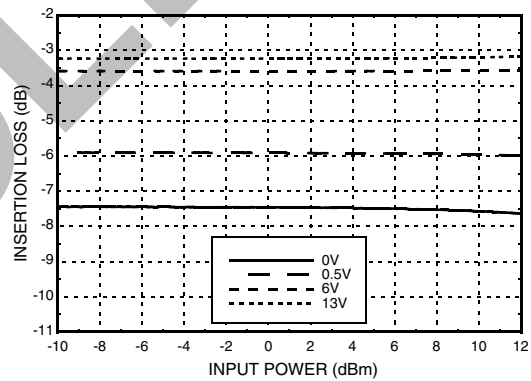

Insertion Loss vs. Pin @ 24 GHz

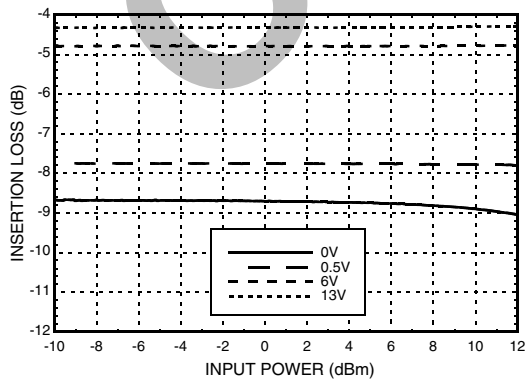

Phase Shift vs. Pin @ 18 GHz

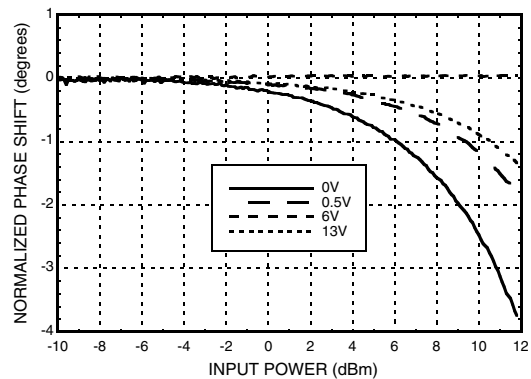

Information furnished by Analog Devices is believed to be accurate and reliable. However, no responsibility is assumed by Analog Devices for its use, nor for any infringements of patents or other rights of third parties that may result from its use. Specifications subject to change without notice. No license is granted by implication or otherwise under any patent or patent rights of Analog Devices. Trademarks and registered trademarks are the property of their respective owners.

For price, delivery, and to place orders: Analog Devices, Inc., One Technology Way, P.O. Box 9106, Norwood, MA 02062-9106 Phone: 781-329-4700 • Order online at www.analog.com Application Support: Phone: 1-800-ANALOG-D



470° ANALOG PHASE SHIFTER, 18 - 24 GHz

Phase Shift vs. Pin @ 21 GHz

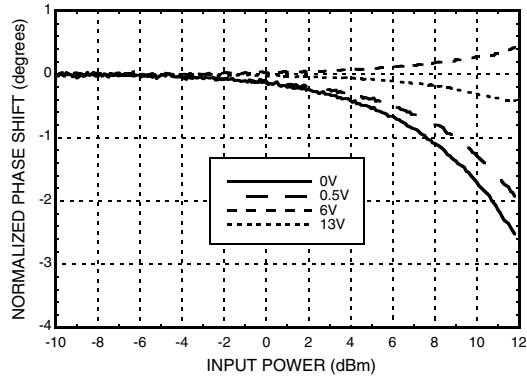

Phase Shift vs. Pin @ 24 GHz

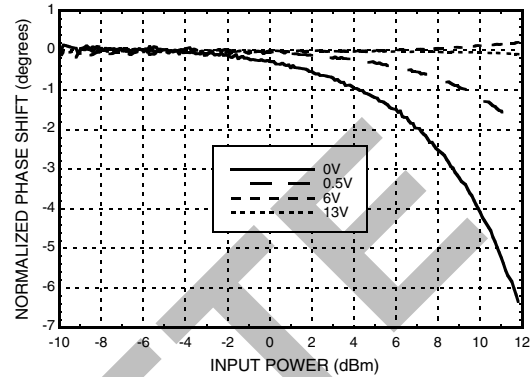

Input Return Loss vs. Frequency, Vctl = 0 to +13V

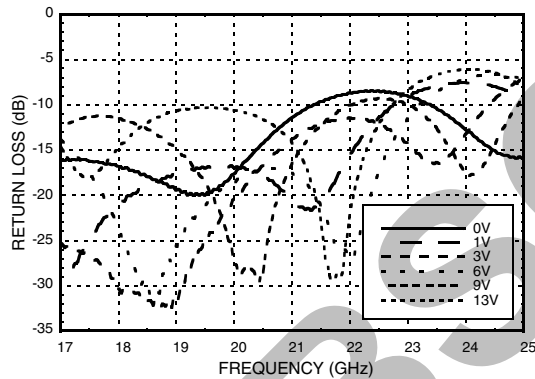

Output Return Loss vs. Frequency, Vctl = 0 to +13V

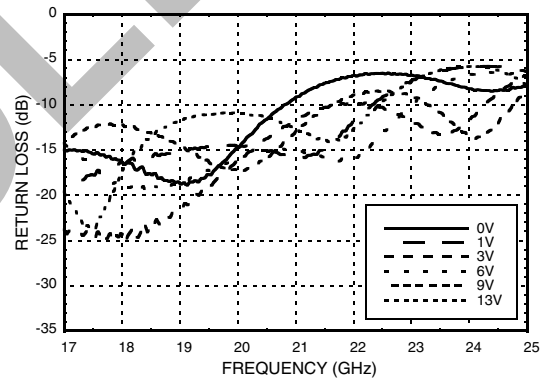

Absolute Maximum Ratings

Input Power (RFIN)	+26 dBm
Control Voltage (Vctl)	-0.5V to +15V
Storage Temperature	-65 to +150 °C
ESD Sensitivity (HBM)	Class 1B

Reliability Information

Junction Temperature (Tj)	150 °C
Nominal Junction Temperature (T = 85 °C, Pin = 10 dBm)	87 °C
Thermal Resistance (Junction to GND Paddle)	80 °C/W
Operating Temperature	-40 to +85 °C



**ELECTROSTATIC SENSITIVE DEVICE
OBSERVE HANDLING PRECAUTIONS**



**470° ANALOG PHASE SHIFTER,
18 - 24 GHz**

Outline Drawing

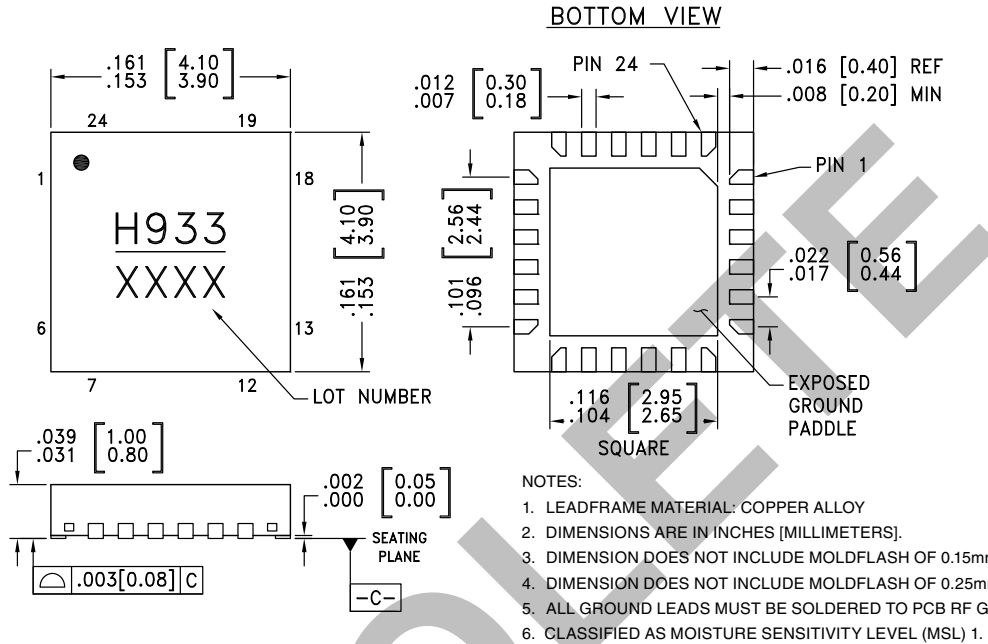

Package Information

Part Number	Package Body Material	Lead Finish	MSL Rating	Package Marking ^[1]
HMC933LP4E	RoHS-compliant Low Stress Injection Molded Plastic	100% matte Sn	MSL1 ^[2]	H933 XXXX

[1] 4-Digit lot number XXXX

[2] Max peak reflow temperature of 260 °C

Pin Descriptions

Pin Number	Function	Description	Interface Schematic
1, 5 - 14, 18 - 20, 22 - 24	N/C	No connection required. These pins may be connected to RF/DC ground without affecting performance.	
2, 4, 15, 17	GND	Ground: Backside of package has exposed metal ground slug that must be connected to ground thru a short path. Vias under the device are required.	
3	RFIN	Port is DC blocked.	
16	RFOUT	Port is DC blocked.	
21	Vctl	Phase shift control pin. Application of a voltage between 0 and 13 volts causes the transmission phase to change. The DC equivalent circuit is a series connected diode and resistor.	



Evaluation PCB

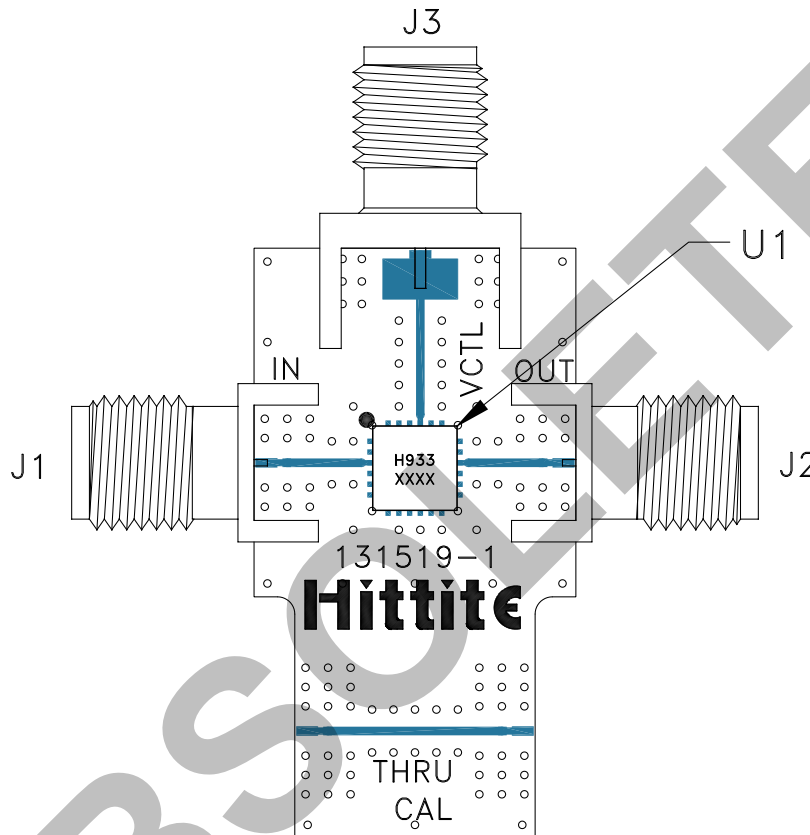

List of Materials for Evaluation PCB 131521 [1]

Item	Description
J1, J2	PCB Mount SMA Connector, SRI
J3	PCB Mount SMA Connector
U1	HMC933LP4E Analog Phase Shifter
PCB [2]	131519 Evaluation PCB

[1] Reference this number when ordering complete evaluation PCB

[2] Circuit Board Material: Rogers 4350

The circuit board used in the application should use RF circuit design techniques. Signal lines should have 50 Ohm impedance while the package ground leads and exposed paddle should be connected directly to the ground plane similar to that shown. A sufficient number of via holes should be used to connect the top and bottom ground planes. The evaluation board should be mounted to an appropriate heat sink. The evaluation circuit board shown is available from Hittite upon request.

X-ON Electronics

Largest Supplier of Electrical and Electronic Components

Click to view similar products for [Phase Detectors / Shifters](#) category:

Click to view products by [Analog Devices](#) manufacturer:

Other Similar products are found below :

[TGP2102](#) [CMD176P4](#) [HMC933LP4ETR](#) [HMC934LP5ETR](#) [HMC647LP6ETR](#) [HMC3716LP4ETR](#) [TGP2108-SM](#) [HMC644ALC5TR](#)
[HMC644ALC5](#) [OPS-0002](#) [MAPS-010145-TR0500](#) [MAPS-010144-TR0500](#) [MAPS-010146-TR0500](#) [HMC642ALC5TR](#) [HMC984LP4ETR](#)
[MC100EP140DG](#) [MC100EP40DTG](#) [MC100LVEL40DWG](#) [MCH12140DG](#) [MCK12140DG](#) [PE44820B-X](#) [QPC2108](#) [MCK12140D](#)
[MC100LVEL40DWR2G](#) [MC100EP140DR2G](#) [TLC2934IPW](#) [TLC2934IPWR](#)