



Das Potential die beste Lösung zu entwickeln

The potential to develop the best solution



PTC Kontaktheizelemente
PTC Conductive Heating Elements

PTC Kontaktheizelemente PTC Conductive Heating Elements

Seit der Firmengründung 1946 befasst sich David+Baader mit dem Thema Elektrowärme und zählt heute weltweit zu den führenden Herstellern von elektrischen Heizelementen und Heizgeräten. DBK hat sich durch konsequente Innovation und Ausnutzung modernster Technologien einen Vorsprung erarbeitet.

DBK has been creating the perfect operating climate for a wide variety of applications since the 1940's. The company has relied on its technical and design expertise to become a world leader in heating technology. Constant research and development by DBK has resulted in a genuine innovation in the industry.

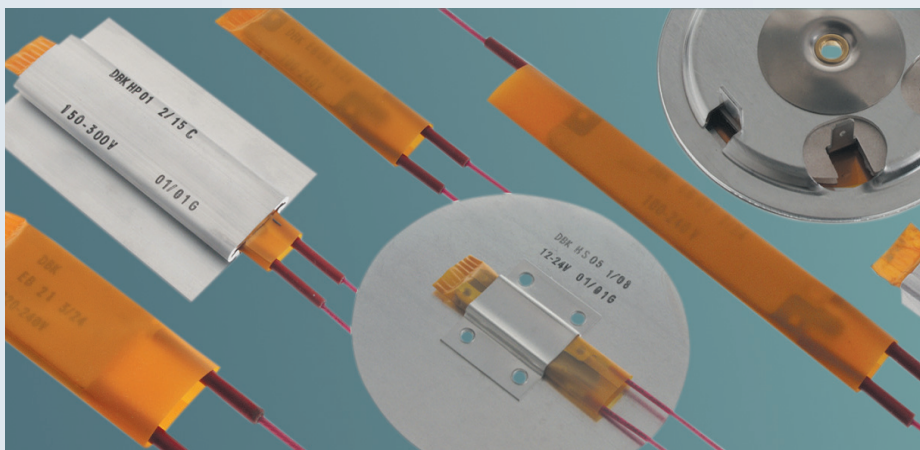

Typen EB, HP, HT

PTC Kontaktheizelemente sind dynamische Heizelemente, die gleichzeitig die Funktionen Heizung und Temperaturbegrenzung beinhalten.

Die Nutzungsmöglichkeiten dieser PTC-Heizelemente sind nahezu grenzenlos. Sie können auf kleinstem Raum integriert werden und zeichnen sich durch eine hohe Leistungsdichte aus.

Zum Temperieren von Festkörpern, Behältern, Flüssigkeiten und Geräten finden sie in der Industrie, in der Medizin und in der Körperpflege sowie in vielen Haushaltsgeräten Verwendung.

Kontaktheizelemente sind untergliedert in die Typenreihen Einbauelemente (EB, EC), Heizprofile (HP) und Heizteller (HT).

Neben den aufgeführten Typen stehen auch Sonderausführungen zur Verfügung.

Types EB, HP, HT

PTC conductive heating elements are dynamic heating elements combining heating and temperature limiting in a single unit. The range of application of PTC heating elements is almost unlimited. The elements need very little mounting space and feature a high power density. They are used for heating of solid bodies, containers, fluids and appliances in industrial, medical and cosmetics sectors as well as on variety of household appliances.

Conductive heating elements are available as build-in elements (EB, EC), heating profiles (HP) and heating discs (HT).

Besides the above types special versions are also available.

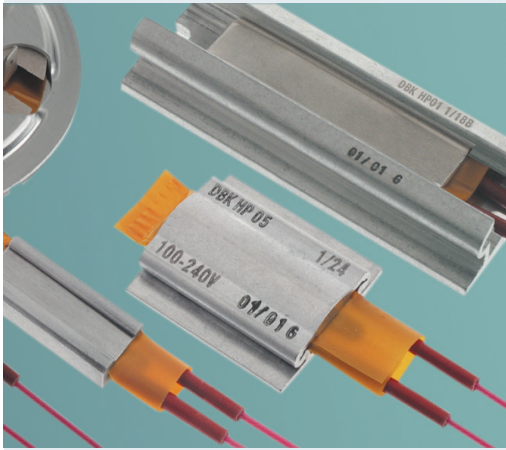

Anwendungen

Nachfolgend einige Anwendungsbeispiele für EB, HP und HT Heizelemente:

- Warmhalteeinrichtungen für Kaffee, Tee und Speisen
- Erwärmung von Behältern mit Flüssigkeiten
- Laminiergeräte
- Videokameras
- Ultraschallreinigungsgeräte
- Haarpflegegeräte
- Kosmetische Geräte
- Massagegeräte
- Inhalationsgeräte
- Ventilbeheizungen
- Antikondens / Antifrost
- Medizintechnische Geräte
- Spielwaren
- Telekommunikation

Besondere Kennzeichen

- Spannungsbereiche 12 - 24 V, 24 - 48 V, 100 - 240 V, Sonderspannungen z.B. 400 V oder 72 V auf Anfrage, 600 V bei HP01 B
- Ausführungen in den Schutzklassen SK I und SK II
- Verschiedene Leistungs- und Temperatúrausführungen lieferbar
- Litzen und Schutzschlauchlängen nach Standard
- Ausführungen nach nationalen und internationalen Sicherheitsvorschriften (VDE, UL, CSA)
- Im Fehlerfall keine Brandgefahr
- Dynamische Heizleistung und Selbstregelfunktion in Abhängigkeit zur Umgebungstemperatur

Applications

The following are some examples from the broad field of application for EB, HP and HT heating elements:

- Hotplates for coffee and teamakers, food warmers
- Heating of fluid-filled vessels
- Laminating equipment
- Video cameras
- Ultrasonic cleaning equipment
- Hair care appliances
- Cosmetic appliances
- Massage appliances
- Inhalation equipment
- Valve heating
- Condensation / frost protection
- Medical apparatus
- Toys
- Telecommunication

Features

- Voltage ranges 12 - 24 V, 24 - 48 V, 100 - 240V, special versions e.g. 400V or 72 V on request, 600 V for HP01 B.
- Protection classes SK I and SK II
- Selection of performances and temperature ranges
- Standard lengths of wires and insulation tubes
- Compliance with national and international safety regulations (VDE, UL, CSA)
- No fire hazard in case of failure
- Dynamic heating output and self regulating function depending on the ambient temperature

Die genannten Informationen entbinden den Kunden nicht von selbstständigen Applikationsprüfungen.

Data is given for illustration purposes only and does not release the customer from independent application tests.

Typen EB, HP, HT Types EB, HP, HT

Einbauelemente (EB, EC)

Basisheizelement, bei dem durch den Einbau in die Applikation eine ausreichende Klemmkontaktierung sichergestellt werden muß. Dies ist notwendig, um eine höchstmögliche Wärmeübertragung dauerhaft zu gewährleisten.

Build-in Elements (EB,EC)

Basic heating elements for installation in sites where sufficient clamping contact must be guaranteed. This is necessary in order to continuously maintain optimum heat transfer.

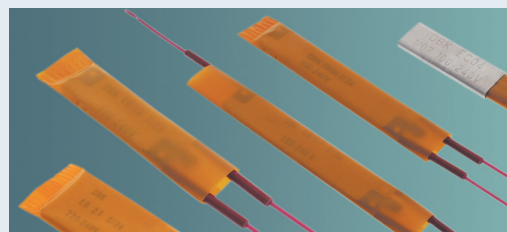

Technische Daten Technical Data		EB03	EB04	EB05	EB05/3	EB06
Temperaturbereich Temperature Range	°C	50 - 240	50 - 240	50 - 240	50 - 240	50 - 240
Maximale Leistung Maximum Power Output	W*	70	45	90	120	160
Maximaler Einschaltstrom bei 230V Max. Inrush Current at 230V	A	2,5	1,0	3,0	4,5	6,0
Abmessungen Dimensions Länge Length x Breite Width x Dicke Thickness	mm	59x9,5x3	40x9,5x3	50x14,5x3	63x14,5x3	83x14,5x3

Heizprofile (HP)

Die HP-Serie zeichnet sich durch einen kompakten Aufbau und eine hohe Leistungsdichte aus. Die flache Bauart des Alugehäuses gewährleistet eine einfache Montage mit optimaler Wärmeübertragung. Die Befestigung der betriebsbereiten Heizung ist über die äußere Profilfläche universell möglich. (z.B. Bohrungen, Stanzungen).

Heating Profiles (HP)

The HP series features a compact design and high power density. The flat aluminium housing can be easily installed and ensures optimum heat transfer. The ready-to-use heating element can be fixed in any place by corresponding fixing holes on the profiles (e.g. drilled or punched mounting holes).

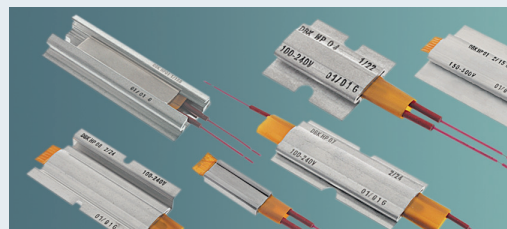

Technische Daten Technical Data		HP01	HP01/B600V	HP01/C	HP02	HP03
Temperaturbereich Temperature Range	°C	50 - 270	50 - 200	50 - 240	50 - 270	50 - 240
Maximale Leistung Maximum Power Output	W*	150	65	200	150	80
Maximaler Einschaltstrom bei 230V Max. Inrush Current at 230V	A	4,5	6,0	6,0	4,5	2,5
Abmessungen Dimensions Länge Length x Breite Width x Dicke Thickness	mm	70x70x9,5	89x34x14	80x54x6,9	70x60x9,5	60x35x8,5

Heizteller (HT)

Hochwertiges und kompaktes Heizelement in runder Bauform mit zentraler Befestigung. Durch konkave Vorspannung der Heizfläche wird eine optimale, formschlüssige Kontaktebene erreicht. Die elektrische Kontaktierung erfolgt über Flachstecker. Die Type HS05 ist eine Sonderbauform der Typenreihe HT. Der Heizteller ist mit einer selbstklebenden Folie zur einfachen Montage ausgestattet.

Heating Discs (HT)

High-quality compact heating element of round shape with central mounting hole. The concave pre-stressed contact surface ensures form-fit contact and thus optimum heat transfer. Equipped with spade terminals for electrical connection. Type HS05 is a special version of the HT series and comes with adhesive foil for easy installation.

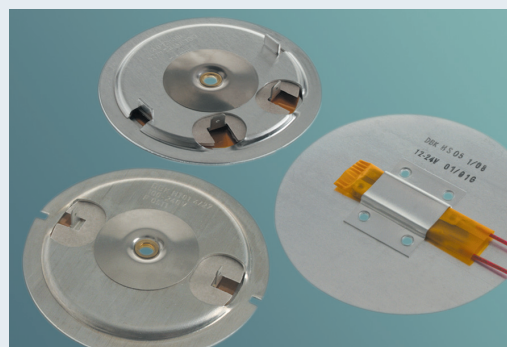

Technische Daten Technical Data		HT01	HT02	HT03	HS05
Temperaturbereich Temperature Range	°C	40 - 300	40 - 300	40 - 300	50 - 130
Maximale Leistung Maximum Power Output	W*	150	150	200	50
Maximaler Einschaltstrom bei 230V Max. Inrush Current at 230V	A	4,0	4,0	4,0	3,0
Abmessungen Dimensions Durchmesser Diameter x Dicke Thickness	mm	95x6,2	95x6,2	100x5	100x5

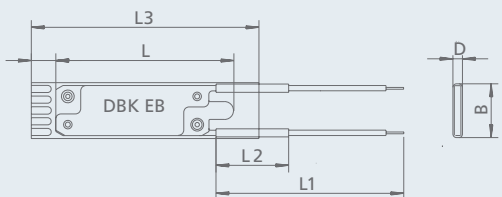

EB07	EB21	EC04	EC05
50 - 240	50 - 270	50 - 240	50 - 240
160	250	40	80
6,0	9,0	1,5	3,0
83 x 14,5 x 3	40 x 30 x 3,4	40 x 13 x 3,9	50 x 18,2 x 3,9

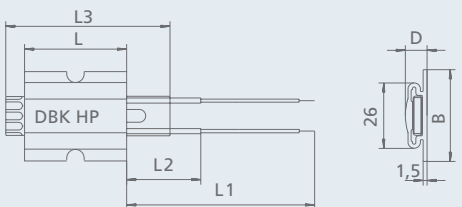

HP04	HP05	HP05/3	HP06	HP07	HP08
50 - 240	50 - 240	50 - 240	50 - 240	50 - 240	50 - 240
60	120	150	200	200	200
1,5	3,0	4,5	6,0	6,0	6,0
40 x 35 x 8,5	40 x 35 x 7,9	50 x 30 x 7,9	75 x 35 x 7,9	75 x 35 x 7,9	75 x 48 x 11,1

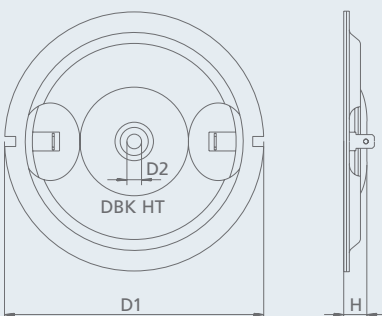

Kennlinienverlauf eines HP-Elements an einem mit 250 ml Wasser gefülltem Prüfbehälter.
 Characteristic Curve of HP-Element on a Test tub filled with 250 ml of Water

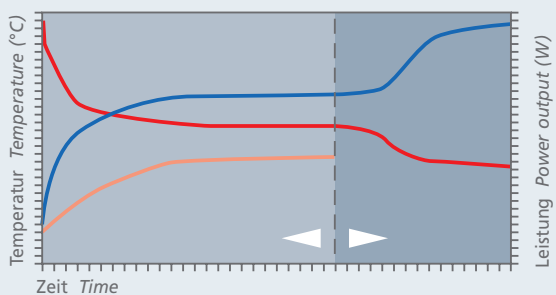

- Profiltemperatur Profile temperature
- Leistung Power
- Wassertemperatur Water temperature
- Gute Wärmeableitung mit Wasser
Good heat transfer with water
- Schlechte Wärmeableitung ohne Wasser
Bad heat transfer without water

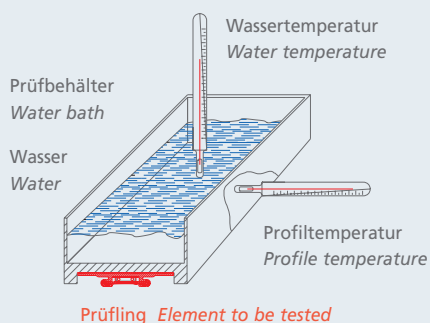

* Leistung in einer wassergefüllten Aluminium-Referenzprüfwanne mit guter Wärmeableitung: Ausgangs- und Umgebungstemperatur 20°C
 * Power output in a waterfilled aluminium test tub with good heat transfer: initial and ambient temperature 20°C



DBK Hauptsitz
DBK Siège
DBK Head Office

DBK David+Baader GmbH
 Rheinstrasse 72 - 74
 Germany - 76870 Kandel
 Phone +49 (0) 7275 703 - 0
 Fax +49 (0) 7275 703 - 249
 info@dbk-group.de
 www.dbk-group.de

DBK Töchter
DBK Représentants
DBK Subsidiaries

DBK France S.A.R.L.
 1, rue Louis Pasteur
 France - 67160 Wissembourg
 Phone +33 (0) 3880 53 85 - 0
 Fax +33 (0) 3880 53 86 9
 info@dbk-france.fr
 www.dbk-france.com

DBK Technitherm Ltd.
 Unit 11, Llantrisant Business Park
 Llantrisant, Wales
 CF72 8LF United Kingdom
 Phone +44 (0) 1443 23 79 27
 Fax +44 (0) 1443 23 78 67
 info@dbktechnitherm.ltd.uk
 www.dbktechnitherm.ltd.uk

DBK Representative Office Moscow
 P.O. Box 114
 Office 308
 117321 Moscow, Russia
 Phone +7 095 258 08 35
 info@dbk-russia.com

DBK Technology Limited
 21/F Harbour Commercial Building
 122 - 124 Connaught Road Central
 Sheung Wan, Hong Kong
 Phone +852 (0) 2401 1011
 Fax +852 (0) 2401 7202
 info@dbk-tech.com

DBK USA Inc.
 1776 Mentor Avenue
 Suite 410
 USA, Cincinnati, OH 45212
 Phone +1 513 351 8880
 Fax +1 513 351 2481
 info@dbk-usa.com
 www.dbk-usa.com

DBK Heizelemente Vertriebs GmbH
 Kasernstrasse 16 - 18/2/8
 Austria - 3500 Krems
 Phone +43 (0) 27 32 - 8 59 71
 Fax +43 (0) 27 32 - 8 59 73
 hellerschmid@ptc-ceramics.com
 www.dbk-group.at

DBK Vertretungen
DBK Filiales
DBK Representatives

Elincom electronics B.V.
 Klaverbaan 101 - 103
 2908 KD Capelle aan den IJssel
 Netherlands
 Phone +31 (0) 10 26 40 270
 Fax +31 (0) 10 26 40 275
 info@elincom.nl
 www.elincom.nl

Eltron electronics B.V.
 Herastraat 51
 5047 TX Tilburg
 Netherlands
 Phone +31 (0) 13 57 80 850
 Fax +31 (0) 13 57 80 950
 info@eltron.nl
 www.eltron.nl

DBK Korea Co.Ltd
 Windstone Bldg Rm 1305
 275 -2 Yangjae-dong Seocho-Ku
 Seoul, Korea
 Phone +82 (0) 257 872 135
 Fax +82 (0) 257 872 16
 dbkkorea@chollian.net

BLAU Barcelonesa d' Activitats
 Comercials, S.A.
 C/DE Les Moreres, 119
 Pol. Ind. Estruch
 08820 El Prat de Llobregat
 Barcelona, Spain
 Phone +34 (0) 93 479 1850
 Fax +34 (0) 93 478 3382
 blau@blaubac.com

Axima, spol. s r.o.
 Videnska 125, 619 00 Brno
 Czech Republic
 Phone +42 (0) 547 42 4021
 Fax +42 (0) 547 42 4023
 axima@axima.cz
 www.axima.cz

JL Systems
 Kalenberg 11
 3210 Lubbeek
 Belgium
 Phone +32 (0) 16 62 04 80
 Fax +32 (0) 16 62 27 08
 jlsystems@skynet.be
 www.jl-systems.be

Dacpol Co. Ltd
 Pulawska 34
 05-500 Piaseczno
 Poland
 Phone +48 (0) 22 750 08 68
 Fax +48 (0) 22 757 07 64
 dacpol@dacpol.com.pl
 www.dacpol.com.pl

Dietrich und Blum AG
 Herbstrasse 31
 CH - 8304 Wailisehen
 Switzerland
 Phone +41 (0) 848 300 700
 Fax +41 (0) 848 300 701
 dbnet@dietrichundblum.ch
 www.dietrichundblum.ch

OEM Electronics AB
 Norrabyvägen 6 B, 1025
 Sweden - 57343 Tranas
 Phone +46 (0) 140 360 600
 Fax +46 (0) 140 360 699
 info@oemelectronics.se
 www.oemelectronics.se

Canalec Inc.
 5150 Rue St.-Patrick
 Montréal, Quebec
 Canada, H4E 4N5
 Phone +1 (0) 514 769 4013
 Fax +1 (0) 514 769 9108
 pszikla@earthlink.net

Euroind srl
 Via F.lli di Dio, 18
 Italy - 20063 Cernusco S/N (MI)
 Phone +39 (0) 292 368 244
 Fax +39 (0) 292 368 215
 sales@deltron-euroind.it
 www.deltron-euroind.it

Ω DBK

HP Series of PTC Heaters

Safe Self regulating temperature output

Ac/Dc working (100 - 240v or 12 - 24v)

Choice of operating temperature (40°C - 290°C)

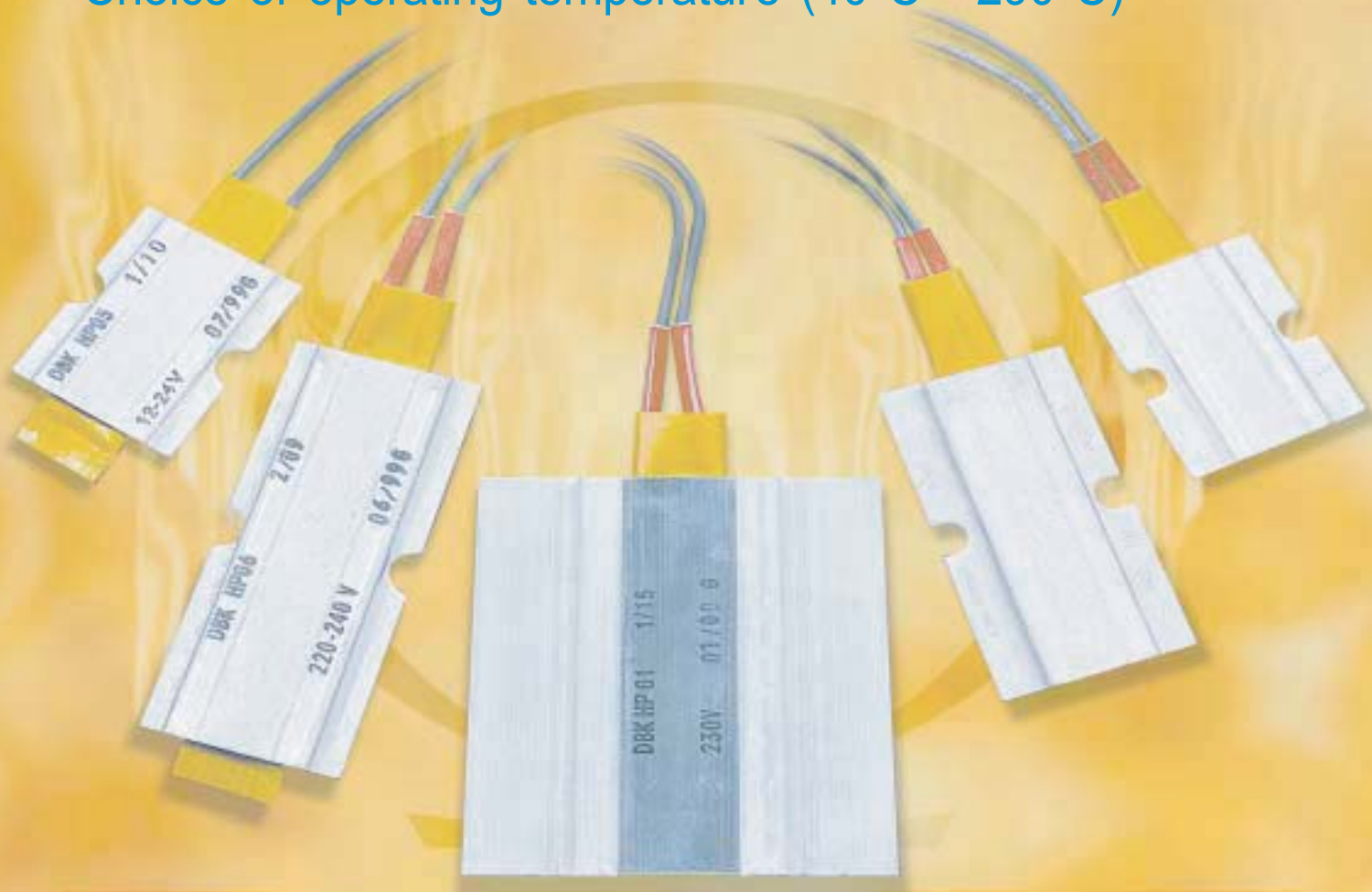

www.ptcheaters.com

DIMENSIONS

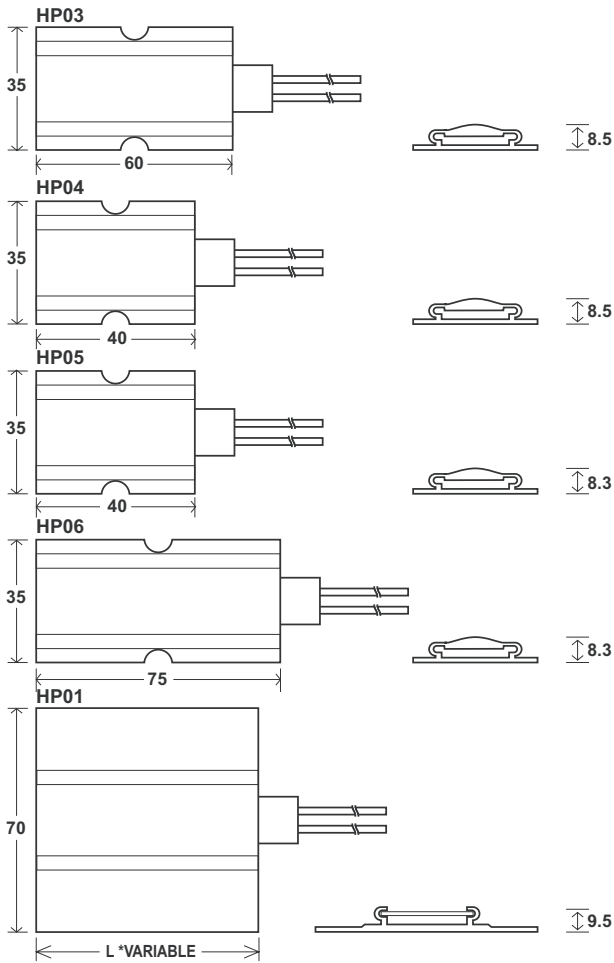

The DBK HP range of Positive Temperature Coefficient (PTC) self regulating heaters have been designed to offer a wide choice of power outputs within a compact series of aluminium profiles. These elements can be operated without the aid of a thermostat or thermal cut-out.

Operating voltages available are 100-240vac/dc or 10-30vac/dc (uni-voltage input). 600mm wire tail versions are available on request.

DESIGN NOTES

$$\text{Power} = K \times A \times T$$

K: Heat transmission factor, sheet steel 5.5W/m² Kelvin (contact OEM for non steel values).

A: Complete surface area of heat losing enclosure (m²).

T: Temperature difference between the ambient air temperature and the specified air temperature of the enclosure.

When considering cabinet heating, place the elements within the lowest part of the enclosure to aid natural convection of the thermal energy.

Assisted forced air convection enhances the power output, thus decreasing the temperature of the element.

APPLICATIONS

Electrical Switchgear Cabinets
CCTV Camera Housing
Telecommunication Cabins
Refrigeration Drip Tray Heating
Street Cabinets
Laboratory Equipment

SPECIFICATION

UL, CSA, VDE
0.5mm² black silicon VDE approved wire
100-240vac/dc, 10-30vac/dc, 30-60vac/dc
IP54 on request
Protection class II
Custom models considered

MODELS MAXIMUM MODELS MAXIMUM OUTPUT OUTPUT

HP03-1/04-24	15W	HP05-1/12-24	55W
HP03-1/05-240	15W	HP05-1/13-24	58W
HP03-1/07-240	20W	HP05-1/14-24	60W
HP03-1/08-24	30W	HP05-1/14-48	60W
HP03-1/09-240	25W	HP05-1/15-240	58W
HP03-1/11-240	30W	HP05-1/20-240	60W
HP04-1/04-24	10W	HP05-1/22-24	70W
HP04-1/05-240	10W	HP06-2/04-24	18W
HP04-1/07-240	15W	HP06-2/05-24	20W
HP04-1/08-24	15W	HP06-2/05-240	20W
HP04-1/09-240	18W	HP06-2/05-48	20W
HP04-1/11-240	20W	HP06-2/07-240	50W
HP04-1/13-240	22W	HP06-2/09-240	70W
HP04-1/18-240	32W	HP06-2/10-24	80W
HP05-1/04-24	20W	HP06-2/11-240	110W
HP05-1/05-24	22W	HP06-2/13-240	145W
HP05-1/05-240	20W	HP06-2/15-240	160W
HP05-1/07-240	25W	HP06-2/18-240	180W
HP05-1/09-240	30W	HP06-2/20-240	200W
HP05-1/10-24	50W	HP06-2/22-24	200W
HP05-1/11-240	35W	HP06-2/24-240	225W

* HP01-2/15-240R1 (250mm Length, L) 140W

* HP01-2/15-240R2 (400mm Length, L) 160W

* HP01-2/15-240R3 (70mm Length, L) 100W

* HP01-4/15-240R1 (250mm Length, L) 280W

* HP01-4/15-240R2 (400mm Length, L) 320W

Note: -24 represents 12-30v operating voltage

-48 represents 30-60v operating voltage

-240 represents 100-240v operating voltage

STANDARD LEAD LENGTH 100mm



European Thermodynamics Limited
Intelligent Thermal Management

PO Box 6744
Leicester LE2 6WS, United Kingdom

Tel: +44 (0)116 292 1501
Fax: +44 (0)116 292 1503
info@etdyn.com
www.etdyn.com

Business registration 4345086 VAT registration 787 3265 86

HP03

PS650.0

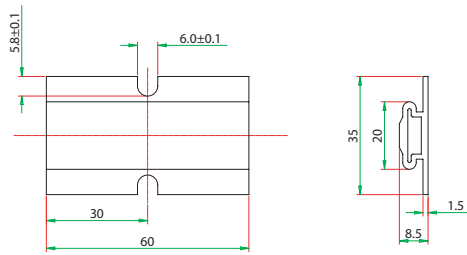

HP05

PS537.1

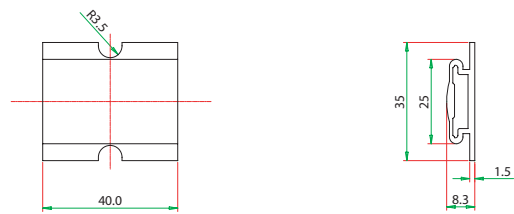

HP04

PS750.0

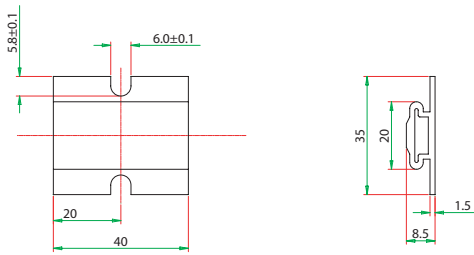

HP06

PS3280.0

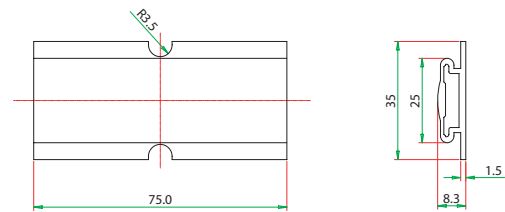

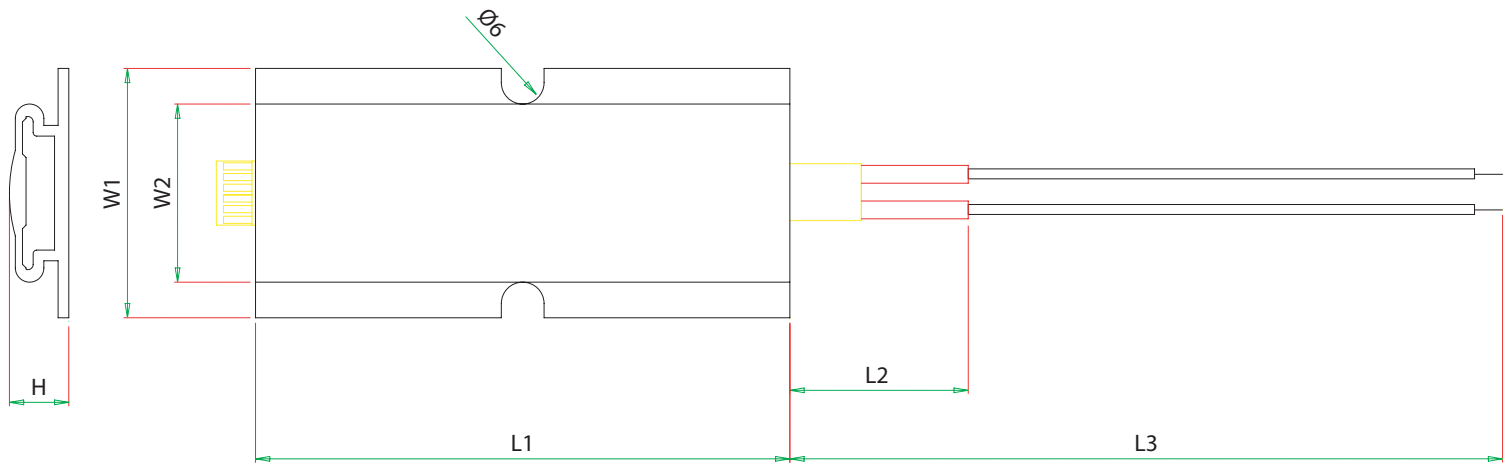

Series	L1 (mm)	L2 (mm)	L3 (mm)	H (mm)	W1 (mm)	W2 (mm)
HP03	60	30	100	8.5	35	20
HP04	40	30	100	8.5	35	20
HP05	40	30	100	8.3	35	25
HP06	75	30	100	8.3	35	25

X-ON Electronics

Largest Supplier of Electrical and Electronic Components

Click to view similar products for [dbk technitherm](#) manufacturer:

Other Similar products are found below :

[HP06-2/09-240](#) [372467,01](#) [372834,01](#) [372466,01](#) [372735,01](#) [FINGER GUARD LARG](#) [NG150](#) [370306,01](#) [371082,01](#) [NG240](#) [15697,6](#)

[HP04-1/04-24](#) [NG100](#) [HP06-2/22-24](#) [NG50](#) [FINGER GUARD SMALL](#) [370089,01](#) [15662](#) [15661,2](#) [NG30](#) [15696,8](#) [371934,01](#) [371680,01](#)

[HP06-2/13-240](#) [370182,01](#) [371604,01](#) [370178,01](#) [370184,01](#) [370177,01](#) [HP05-1/04-24](#)