

Current Transducer HO-NP series

$I_{PN} = 40, 60, 120, 150 \text{ A}$

Ref: HO 40-NP, HO 60-NP, HO 120-NP, HO 150-NP

For the electronic measurement of current: DC, AC, pulsed..., with galvanic separation between the primary and the secondary circuit.



RoHS c  US

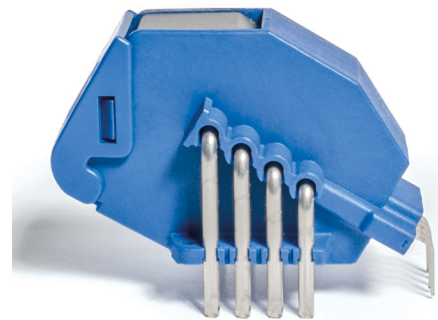

Features

- Open loop multi-range current transducer
- Voltage output
- Single power supply +5 V
- Over-current detect $2.93 \times I_{PN}$ (peak value)
- EEPROM Control
- Galvanic separation between primary and secondary circuit
- Low power consumption
- Compact design for THT PCB mounting
- Factory calibrated
- **Dedicated parameter settings available on request (see page 10).**

Advantages

- Low offset drift
- Over-drivable V_{ref}
- 8 mm creepage /clearance
- Fast response.

Applications

- AC variable speed and servo motor drives
- Static converters for DC motor drives
- Battery supplied applications
- Uninterruptible Power Supplies (UPS)
- Switched Mode Power Supplies (SMPS)
- Power supplies for welding applications
- Combiner box
- Solar inverter on DC side of the inverter (MPPT).

Standards

- EN 50178: 1997
- IEC 61010-1: 2010
- IEC 61326-1: 2012
- UL 508: 2010.

Application Domain

- Industrial.

Absolute maximum ratings

Parameter	Symbol	Unit	Value
Supply voltage (not destructive)	U_C	V	8
Supply voltage (not entering non standard modes)	U_C	V	6.5
Primary conductor temperature	T_B	°C	120
ESD rating, Human Body Model (HBM)	U_{ESD}	kV	2

Stresses above these ratings may cause permanent damage. Exposure to absolute maximum ratings for extended periods may degrade reliability.

UL 508: Ratings and assumptions of certification

File # E189713 Volume: 2 Section: 5

Standards

- CSA C22.2 NO. 14-10 INDUSTRIAL CONTROL EQUIPMENT - Edition 11 - Revision Date 2011/08/01
- UL 508 STANDARD FOR INDUSTRIAL CONTROL EQUIPMENT - Edition 17 - Revision Date 2010/04/15

Ratings

Parameter	Symbol	Unit	Value
Primary involved potential		V AC/DC	600
Max surrounding air temperature	T_A	°C	105
Primary current	I_P	A	According to series primary current
Secondary supply voltage	U_C	V DC	5
Output voltage	V_{out}	V	0 to 5

Conditions of acceptability

- 1 - These devices have been evaluated for overvoltage category III and for use in pollution degree 2 environment.
- 2 - A suitable enclosure shall be provided in the end-use application.
- 3 - The terminals have not been evaluated for field wiring.
- 4 - These devices are intended to be mounted on a printed wiring board of end use equipment. The suitability of the connections (including spacings) shall be determined in the end-use application.
- 5 - Primary terminals shall not be straightened since assembly of housing case depends upon bending of the terminals.
- 6 - Any surface of polymeric housing have not been evaluated as insulating barrier.
- 7 - Low voltage control circuit shall be supplied by an isolating source (such as a transformer, optical isolator, limiting impedance or electro-mechanical relay).

Marking

Only those products bearing the UR Mark should be considered to be Listed or Recognized and covered under UL's Follow-Up Service. Always look for the Mark on the product.

Insulation coordination

Parameter	Symbol	Unit	Value	Comment
Rms voltage for AC insulation test 50/60 Hz/1 min	U_d	kV	4.3	
Impulse withstand voltage 1.2/50 μ s	\hat{U}_w	kV	8	
Partial discharge extinction rms voltage @ 10 pC	U_e	V	> 930	Primary / Secondary
Clearance (pri. - sec.)	d_{Cl}	mm	> 8	Shortest distance through air
Creepage distance (pri. - sec.)	d_{Cp}	mm	> 8	Shortest path along device body
Clearance (pri. - sec.)		mm	> 8	When mounted on PCB with recommended layout
Case material			V0 according to UL 94	
Comparative tracking index	CTI		600	
Application example	-	-	600 V CAT III PD2	Reinforced insulation, non uniform field according to EN 50178, EN 61010
Application example	-	-	1000 V CAT III PD2	Based insulation, non uniform field according to EN 50178, EN 61010
Application example	-	-	600 V CAT III PD2	Simple insulation, non uniform field according to UL 508

Environmental and mechanical characteristics

Parameter	Symbol	Unit	Min	Typ	Max	Comment
Ambient operating temperature	T_A	$^{\circ}$ C	-40		105	
Ambient storage temperature	T_s	$^{\circ}$ C	-40		105	
Mass	m	g		31		

Electrical data HO 40-NP-0100

 At $T_A = 25\text{ °C}$, $U_C = +5\text{ V}$, $R_L = 10\text{ k}\Omega$ unless otherwise noted (see Min, Max, typ. definition paragraph in page 11).

Parameter	Symbol	Unit	Min	Typ	Max	Comment
Primary nominal rms current	I_{PN}	A		40		
Primary current, measuring range	I_{PM}	A	-100		100	@ $U_C \geq 4.6\text{ V}$
Number of primary turns	N_p			1,2,4		See application information
Primary jumper resistance @ +25 °C	R_p	m Ω		0.09		4 jumpers in parallel
Primary jumper resistance @ +120 °C	R_p	m Ω		0.12		4 jumpers in parallel
Supply voltage ¹⁾	U_C	V	4.5	5	5.5	
Current consumption	I_C	mA		19	25	
Reference voltage (output)	V_{ref}	V	2.48	2.5	2.52	Internal reference
Reference voltage (input)	V_{ref}	V	0.5		2.65	External reference
Output voltage range @ I_{PM}	$V_{out} - V_{ref}$	V	-2		2	Over operating temperature range
V_{ref} output resistance	R_{ref}	Ω	130	200	300	Series
V_{out} output resistance	R_{out}	Ω		2	5	Series
Allowed capacitive load	C_L	nF	0		6	
OCD output: On resistance	R_{on}	Ω	70	95	150	Open drain, active low Over operating temperature range
OCD output: Hold time	t_{hold}	ms	0.7	1	1.4	Additional time after threshold has released
EEPROM control	V_{out}	mV	0		50	V_{out} forced to GND when EEPROM in an error state ²⁾
Electrical offset voltage @ $I_p = 0\text{ A}$	V_{OE}	mV	-5		5	$V_{out} - V_{ref}$ @ $V_{ref} = 2.5\text{ V}$
Electrical offset current Referred to primary	I_{OE}	A	-0.25		0.25	
Temperature coefficient of V_{ref}	TCV_{ref}	ppm/K	-170		170	-40 °C ... 105 °C
Temperature coefficient of V_{OE}	TCV_{OE}	mV/K	-0.075		0.075	-40 °C ... 105 °C
Offset drift referred to primary @ $I_p = 0\text{ A}$	TCI_{OE}	mA/K	-3.75		3.75	-40 °C ... 105 °C
Theoretical sensitivity	G_{th}	mV/A		20		800 mV @ I_{PN}
Sensitivity error @ I_{PN}	ϵ_G	%	-0.75		0.75	Factory adjustment, 1 turn configuration, 4 jumpers in parallel
Temperature coefficient of G	TCG	ppm/K	-200		200	-40 °C ... 105 °C
Linearity error 0 ... I_{PN}	ϵ_L	% of I_{PN}	-0.75		0.75	
Linearity error 0 ... I_{PM}	ϵ_L	% of I_{PM}	-0.5		0.5	
Magnetic offset current (@ $10 \times I_{PN}$) referred to primary	I_{OM}	A	-0.8		0.8	One turn
Reaction time @ 10 % of I_{PN}	t_{ra}	μs			2	@ 50 A/ μs
Response time @ 90 % of I_{PN}	t_r	μs			2.5	@ 50 A/ μs
Frequency bandwidth (-3 dB)	BW	kHz		350		
Output rms voltage noise (spectral density) (100 Hz ... 100 kHz)	e_{no}	$\mu\text{V}/\sqrt{\text{Hz}}$			16	
Output voltage noise (DC ... 10 kHz) (DC ... 100 kHz) (DC ... 1 MHz)	V_{no}	mVpp		8 25 46.2		
Over-current detect		A	$2.64 \times I_{PN}$	$2.93 \times I_{PN}$	$3.22 \times I_{PN}$	Peak value $\pm 10\%$
Accuracy @ I_{PN}	X	% of I_{PN}	-1.5		1.5	
Accuracy @ I_{PN} @ $T_A = +105\text{ °C}$	X	% of I_{PN}	-3.85		3.85	See formula note ³⁾
Accuracy @ I_{PN} @ $T_A = +85\text{ °C}$	X	% of I_{PN}	-3.26		3.26	See formula note ³⁾

 Notes: ¹⁾ 3.3 V SP version available

²⁾ EEPROM in an error state makes the transducer behave like a reverse current saturation. Use of the OCD may help to differentiate the two cases.

³⁾ Accuracy @ X_{TA} (% of I_{PN}) = $X + (\frac{TCG}{10000} \times (T_A - 25) + \frac{TCI_{OE}}{1000 \times I_p} \times 100 \times (T_A - 25))$.

Electrical data HO 60-NP-0100

 At $T_A = 25\text{ °C}$, $U_C = +5\text{ V}$, $R_L = 10\text{ k}\Omega$ unless otherwise noted (see Min, Max, typ. definition paragraph in page 11).

Parameter	Symbol	Unit	Min	Typ	Max	Comment
Primary nominal rms current	I_{PN}	A		60		
Primary current, measuring range	I_{PM}	A	-150		150	@ $U_C \geq 4.6\text{ V}$
Number of primary turns	N_p			1,2,4		See application information
Primary jumper resistance @ +25 °C	R_p	mΩ		0.09		4 jumpers in parallel
Primary jumper resistance @ +120 °C	R_p	mΩ		0.12		4 jumpers in parallel
Supply voltage ¹⁾	U_C	V	4.5	5	5.5	
Current consumption	I_C	mA		19	25	
Reference voltage (output)	V_{ref}	V	2.48	2.5	2.52	Internal reference
Reference voltage (input)	V_{ref}	V	0.5		2.65	External reference
Output voltage range @ I_{PM}	$V_{out} - V_{ref}$	V	-2		2	Over operating temperature range
V_{ref} output resistance	R_{ref}	Ω	130	200	300	Series
V_{out} output resistance	R_{out}	Ω		2	5	Series
Allowed capacitive load	C_L	nF	0		6	
OCD output: On resistance	R_{on}	Ω	70	95	150	Open drain, active low, Over operating temperature range
OCD output: Hold time	t_{hold}	ms	0.7	1	1.4	Additional time after threshold has released
EEPROM control	V_{out}	mV	0		50	V_{out} forced to GND when EEPROM in an error state ²⁾
Electrical offset voltage @ $I_p = 0\text{ A}$	V_{OE}	mV	-5		5	$V_{out} - V_{ref}$ @ $V_{ref} = 2.5\text{ V}$
Electrical offset current Referred to primary	I_{OE}	A	-0.375		0.375	
Temperature coefficient of V_{ref}	TCV_{ref}	ppm/K	-170		170	-40 °C ... 105 °C
Temperature coefficient of V_{OE}	TCV_{OE}	mV/K	-0.075		0.075	-40 °C ... 105 °C
Offset drift referred to primary @ $I_p = 0\text{ A}$	TCI_{OE}	mA/K	-5.625		5.625	-40 °C ... 105 °C
Theoretical sensitivity	G_{th}	mV/A		13.333		800 mV @ I_{PN}
Sensitivity error @ I_{PN}	ϵ_G	%	-0.75		0.75	Factory adjustment, 1 turn configuration, 4 jumpers in parallel
Temperature coefficient of G	TCG	ppm/K	-200		200	-40 °C ... 105 °C
Linearity error 0 ... I_{PN}	ϵ_L	% of I_{PN}	-0.65		0.65	
Linearity error 0 ... I_{PM}	ϵ_L	% of I_{PM}	-0.5		0.5	
Magnetic offset current (@ $10 \times I_{PN}$) referred to primary	I_{OM}	A	-0.8		0.8	One turn
Reaction time @ 10 % of I_{PN}	t_{ra}	μs			2	@ 50 A/μs
Response time @ 90 % of I_{PN}	t_r	μs			2.5	@ 50 A/μs
Frequency bandwidth (-3 dB)	BW	kHz		350		
Output rms voltage noise (spectral density) (100 Hz ... 100 kHz)	e_{no}	μV/√Hz			11	
Output voltage noise (DC ... 10 kHz) (DC ... 100 kHz) (DC ... 1 MHz)	V_{no}	mVpp		5.7 16.5 31.1		
Over-current detect		A	$2.64 \times I_{PN}$	$2.93 \times I_{PN}$	$3.22 \times I_{PN}$	Peak value ±10 %
Accuracy @ I_{PN}	X	% of I_{PN}	-1.4		1.4	
Accuracy @ I_{PN} @ $T_A = +105\text{ °C}$	X	% of I_{PN}	-3.75		3.75	See formula note ³⁾
Accuracy @ I_{PN} @ $T_A = +85\text{ °C}$	X	% of I_{PN}	-3.16		3.16	See formula note ³⁾

 Notes: ¹⁾ 3.3 V SP version available

²⁾ EEPROM in an error state makes the transducer behave like a reverse current saturation. Use of the OCD may help to differentiate the two cases.

$$\sup>3) Accuracy @ X_{TA} (% of I_{PN}) = $X + \left(\frac{TCG}{10000} \times (T_A - 25) + \frac{TCI_{OE}}{1000 \times I_p} \times 100 \times (T_A - 25) \right)$.$$

Electrical data HO 120-NP-0100

 At $T_A = 25\text{ °C}$, $U_C = +5\text{ V}$, $R_L = 10\text{ k}\Omega$ unless otherwise noted (see Min, Max, typ. definition paragraph in page 11).

Parameter	Symbol	Unit	Min	Typ	Max	Comment
Primary nominal rms current	I_{PN}	A		120		
Primary current, measuring range	I_{PM}	A	-300		300	@ $U_C \geq 4.6\text{ V}$
Number of primary turns	N_p			1,2,4		See application information
Primary jumper resistance @ +25 °C	R_p	m Ω		0.09		4 jumpers in parallel
Primary jumper resistance @ +120 °C	R_p	m Ω		0.12		4 jumpers in parallel
Supply voltage ¹⁾	U_C	V	4.5	5	5.5	
Current consumption	I_C	mA		19	25	
Reference voltage (output)	V_{ref}	V	2.48	2.5	2.52	Internal reference
Reference voltage (input)	V_{ref}	V	0.5		2.65	External reference
Output voltage range @ I_{PM}	$V_{out} - V_{ref}$	V	-2		2	Over operating temperature range
V_{ref} output resistance	R_{ref}	Ω	130	200	300	Series
V_{out} output resistance	R_{out}	Ω		2	5	Series
Allowed capacitive load	C_L	nF	0		6	
OCD output: On resistance	R_{on}	Ω	70	95	150	Open drain, active low, Over operating temperature range
OCD output: Hold time	t_{hold}	ms	0.7	1	1.4	Additional time after threshold has released
EEPROM control	V_{out}	mV	0		50	V_{out} forced to GND when EEPROM in an error state ²⁾
Electrical offset voltage @ $I_p = 0\text{ A}$	V_{OE}	mV	-5		5	$V_{out} - V_{ref}$ @ $V_{ref} = 2.5\text{ V}$
Electrical offset current Referred to primary	I_{OE}	A	-0.75		0.75	
Temperature coefficient of V_{ref}	TCV_{ref}	ppm/K	-170		170	-40 °C ... 105 °C
Temperature coefficient of V_{OE}	TCV_{OE}	mV/K	-0.075		0.075	-40 °C ... 105 °C
Offset drift referred to primary @ $I_p = 0\text{ A}$	TCI_{OE}	mA/K	-11.25		11.25	-40 °C ... 105 °C
Theoretical sensitivity	G_{th}	mV/A		6.667		800 mV @ I_{PN}
Sensitivity error @ I_{PN}	ϵ_G	%	-0.75		0.75	Factory adjustment, 1 turn configuration, 4 jumpers in parallel
Temperature coefficient of G	TCG	ppm/K	-200		200	-40 °C ... 105 °C
Linearity error 0 ... I_{PN}	ϵ_L	% of I_{PN}	-0.5		0.5	
Linearity error 0 ... I_{PM}	ϵ_L	% of I_{PM}	-0.5		0.5	
Magnetic offset current (@ $10 \times I_{PN}$) referred to primary	I_{OM}	A	-0.8		0.8	One turn
Reaction time @ 10 % of I_{PN}	t_{ra}	μ s			2	@ 50 A/ μ s
Response time @ 90 % of I_{PN}	t_r	μ s			2.5	@ 50 A/ μ s
Frequency bandwidth (-3 dB)	BW	kHz		350		
Output rms voltage noise (spectral density) (100 Hz ... 100 kHz)	e_{no}	μ V/ $\sqrt{\text{Hz}}$			6.1	
Output voltage noise (DC ... 10 kHz) (DC ... 100 kHz) (DC ... 1 MHz)	V_{no}	mVpp		3.6 8.9 17.1		
Over-current detect		A	$2.64 \times I_{PN}$	$2.93 \times I_{PN}$	$3.22 \times I_{PN}$	Peak value $\pm 10\%$
Accuracy @ I_{PN}	X	% of I_{PN}	-1.25		1.25	
Accuracy @ I_{PN} @ $T_A = +105\text{ °C}$	X	% of I_{PN}	-3.60		3.60	See formula note ³⁾
Accuracy @ I_{PN} @ $T_A = +85\text{ °C}$	X	% of I_{PN}	-3.01		3.01	See formula note ³⁾

 Notes: ¹⁾ 3.3 V SP version available

²⁾ EEPROM in an error state makes the transducer behave like a reverse current saturation. Use of the OCD may help to differentiate the two cases.

$$\supset \text{Accuracy @ } X_{TA} (\% \text{ of } I_{PN}) = X + \left(\frac{TCG}{10000} \times (T_A - 25) \right) + \left(\frac{TCI_{OE}}{1000 \times I_p} \times 100 \times (T_A - 25) \right).$$

Electrical data HO 150-NP-0100

 At $T_A = 25\text{ °C}$, $U_C = +5\text{ V}$, $R_L = 10\text{ k}\Omega$ unless otherwise noted (see Min, Max, typ. definition paragraph in page 11).

Parameter	Symbol	Unit	Min	Typ	Max	Comment
Primary nominal rms current	I_{PN}	A		150		
Primary current, measuring range 85 °C ¹⁾ 105 °C	I_{PM}	A	-375 -360		375 360	@ $U_C \geq 4.6\text{ V}$
Number of primary turns	N_p			1,2,4		See application information
Primary jumper resistance @ +25 °C	R_p	m Ω		0.09		4 jumpers in parallel
Primary jumper resistance @ +120 °C	R_p	m Ω		0.12		4 jumpers in parallel
Supply voltage ²⁾	U_C	V	4.5	5	5.5	
Current consumption	I_C	mA		19	25	
Reference voltage (output)	V_{ref}	V	2.48	2.5	2.52	Internal reference
Reference voltage (input)	V_{ref}	V	0.5		2.65	External reference
Output voltage range @ I_{PM}	$V_{out} - V_{ref}$	V	-2		2	Over operating temperature range
V_{ref} output resistance	R_{ref}	Ω	130	200	300	Series
V_{out} output resistance	R_{out}	Ω		2	5	Series
Allowed capacitive load	C_L	nF	0		6	
OCD output: On resistance	R_{on}	Ω	70	95	150	Open drain, active low, Over operating temperature range
OCD output: Hold time	t_{hold}	ms	0.7	1	1.4	Additional time after threshold has released
EEPROM control	V_{out}	mV	0		50	V_{out} forced to GND when EEPROM in an error state ³⁾
Electrical offset voltage @ $I_p = 0\text{ A}$	V_{OE}	mV	-5		5	$V_{out} - V_{ref}$ @ $V_{ref} = 2.5\text{ V}$
Electrical offset current Referred to primary	I_{OE}	A	-0.9375		0.9375	
Temperature coefficient of V_{ref}	TCV_{ref}	ppm/K	-170		170	-40 °C ... 105 °C
Temperature coefficient of V_{OE}	TCV_{OE}	mV/K	-0.075		0.075	-40 °C ... 105 °C
Offset drift referred to primary @ $I_p = 0\text{ A}$	TCI_{OE}	mA/K	-14.0625		14.0625	-40 °C ... 105 °C
Theoretical sensitivity	G_{th}	mV/A		5.333		800 mV @ I_{PN}
Sensitivity error @ I_{PN}	ϵ_G	%	-0.75		0.75	Factory adjustment, 1 turn configuration, 4 jumpers in parallel
Temperature coefficient of G	TCG	ppm/K	-200		200	-40 °C ... 105 °C
Linearity error 0 ... I_{PN}	ϵ_L	% of I_{PN}	-0.4		0.4	
Linearity error 0 ... I_{PM}	ϵ_L	% of I_{PM}	-0.5		0.5	
Magnetic offset current (@ $10 \times I_{PN}$) referred to primary	I_{OM}	A	-0.8		0.8	One turn
Reaction time @ 10 % of I_{PN}	t_{ra}	μ s			2	@ 50 A/ μ s
Response time @ 90 % of I_{PN}	t_r	μ s			2.5	@ 50 A/ μ s
Frequency bandwidth (-3 dB)	BW	kHz		350		
Output rms voltage noise (spectral density) (100 Hz ... 100 kHz)	e_{no}	μ V/ $\sqrt{\text{Hz}}$			5.2	
Output voltage noise (DC ... 10 kHz) (DC ... 100 kHz) (DC ... 1 MHz)	V_{no}	mVpp		3.2 7 15.3		
Over-current detect		A	$2.64 \times I_{PN}$	$2.93 \times I_{PN}$	$3.22 \times I_{PN}$	Peak value $\pm 10\%$
Accuracy @ I_{PN}	X	% of I_{PN}	-1.15		1.15	
Accuracy @ I_{PN} @ $T_A = +105\text{ °C}$	X	% of I_{PN}	-3.50		3.50	See formula note ⁴⁾
Accuracy @ I_{PN} @ $T_A = +85\text{ °C}$	X	% of I_{PN}	-2.91		2.91	See formula note ⁴⁾

 Notes: ¹⁾ Magnetic core temperature remaining equal or less than ambient temperature T_A
²⁾ 3.3 V SP version available

³⁾ EEPROM in an error state makes the transducer behave like a reverse current saturation. Use of the OCD may help to differentiate the two cases ⁴⁾

⁴⁾ Accuracy @ X_{TA} (% of I_{PN}) = $X + \left(\frac{TCG}{10000} \times (T_A - 25) + \frac{TCI_{OE}}{1000 \times I_p} \times 100 \times (T_A - 25) \right)$.

HO-NP series, measuring range versus external reference voltage

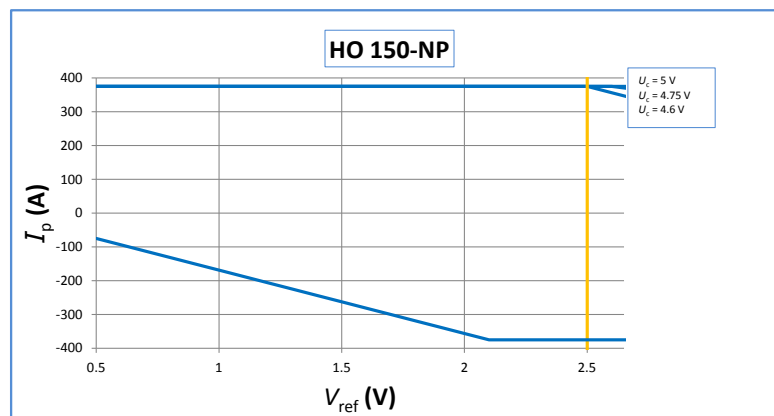
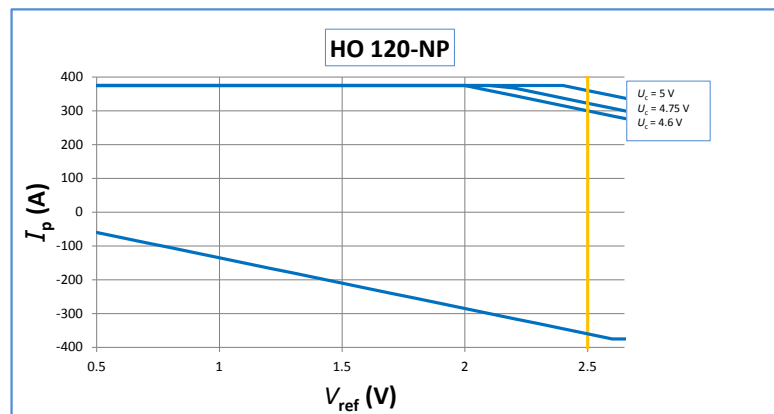
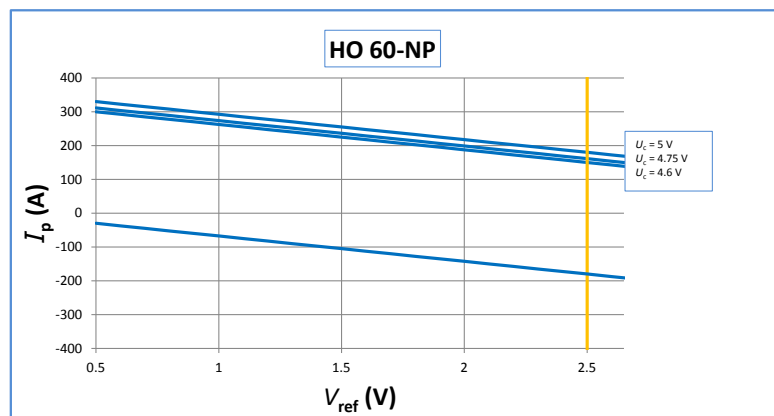
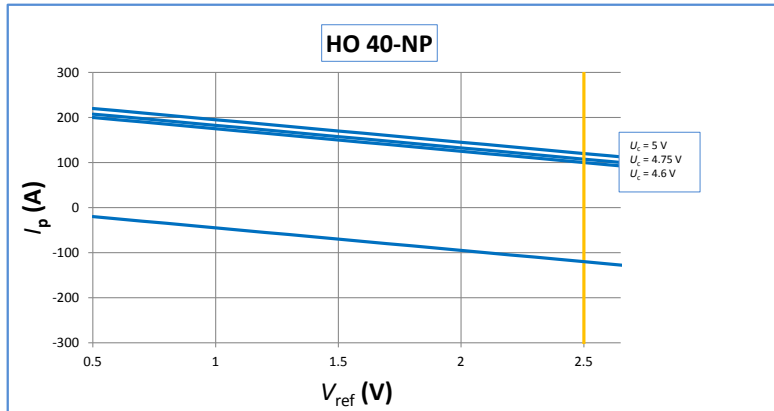

Maximum continuous DC current

For all ranges:

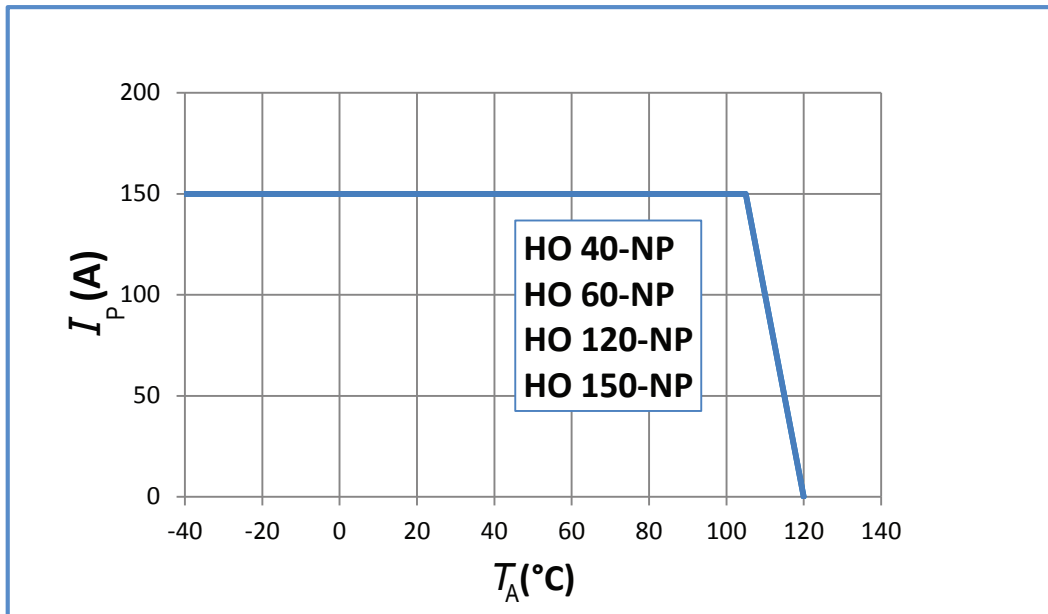

Important notice: whatever the usage and/or application, the transducer jumper temperature shall not go above the maximum rating of 120 °C as stated in page 2 of this datasheet.

HO-NP series: name and codification

HO family products may be ordered **on request** ¹⁾ with a dedicated setting of the parameters as described below (standards products are delivered with the setting 0100 according to the table).

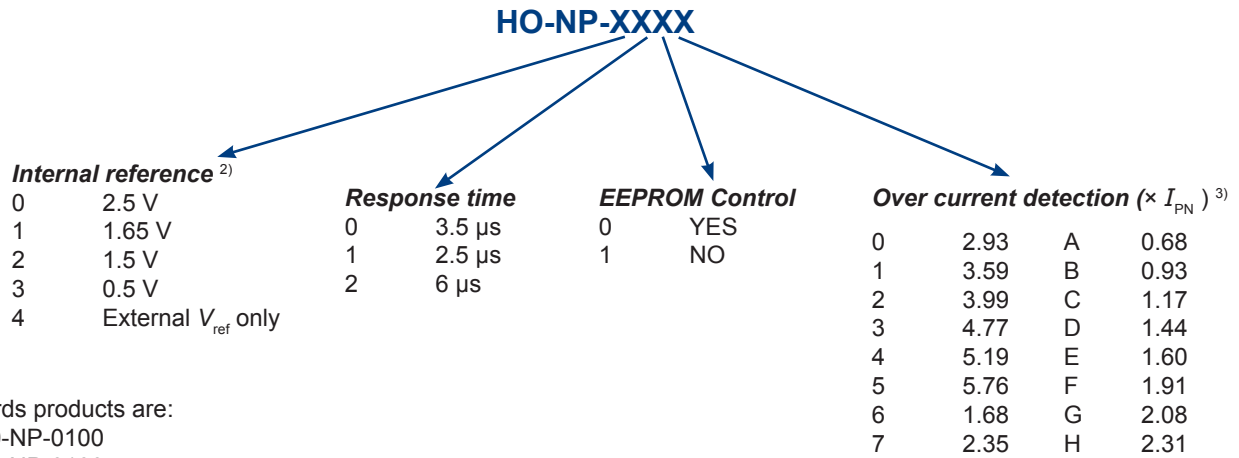

- Standards products are:
- HO 40-NP-0100
 - HO 60-NP-0100
 - HO 120-NP-0100
 - HO 150-NP-0100

Notes: ¹⁾ For dedicated settings, minimum quantities apply, please contact your local LEM support.

²⁾ V_{ref} electrical data

V_{ref} parameter	V_{ref} (V)			TCV_{ref} (ppm/K)	
	min	typ	max	min	max
0	2.48	2.5	2.52	-170	-70
1	1.63	1.65	1.67	-170	170
2	1.48	1.5	1.52	-170	170
3	0.49	0.5	0.51	-250	250

³⁾ OCD ($\times I_{PN}$) correction table versus range and temperature
All other values or empty cells: no change

HO-NP-010x					HO-NP-010x					HO-NP-010x				
OCD Parameter	I_{PN} (A) @ 25 °C				OCD Parameter	I_{PN} (A) @ 85 °C				OCD Parameter	I_{PN} (A) @ 105 °C			
	40	60	120	150		40	60	120	150		40	60	120	150
A					A					A				
B					B					B				
C					C					C				
D					D					D				
E					E					E				
6					6					6				
F					F					F				
G					G					G				
H					H					H				
7					7					7				
0					0					0				2.98
1					1				4.05	1				4.39
2				4.19	2			4.01	5.00	2			4.38	5.38
3				6.17	3			5.72	-	3			6.17	-
4				5.71	4			6.77	-	4			7.26	-
5				7.16	5			-	-	5			-	-

Tolerance on OCD value	
±20 %	
±15 %	
±10 %	No change
-	Do not use

HO-NP series: output compatibility with HAIS Series

Reference	I_{PN} (A)	I_{PM} (A)	I_{PM} / I_{PN}	$V_{out} - V_{ref}$ @ I_{PN} (V)	Reference	I_{PN} (A)	I_{PM} (A)	I_{PM} / I_{PN}	$V_{out} - V_{ref}$ @ I_{PN} (V)
HO 40-NP	40	100	2.5	0.8					
HO 60-NP	60	150	2.5	0.8	HAIS 50-TP	50	150	3	0.625
HO 120-NP	120	300	2.5	0.8	HAIS 100-TP	100	300	3	0.625
HO 150-NP	150	375	2.5	0.8					

The HO-NP gives the same output levels as the HAIS-TP referring to the HAIS nominal currents. This allows easier replacement of HAIS by HO-NP in existing applications.

Application information

Possibilities between range selection and number of turns ^{1) 2)}

Number of primary turns	Primary current			
	$I_{PN} = 40$ A	$I_{PN} = 60$ A	$I_{PN} = 120$ A	$I_{PN} = 150$ A
1	40 A	60 A	120 A	150 A
2	20 A	30 A	60 A	75 A
4	10 A	15 A	30 A	37.5 A

Connection diagram

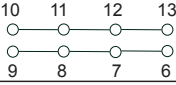
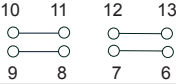
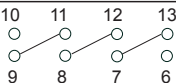
Number of primary turns	Primary resistance current rms R_p (m Ω) @ $T_A = 25$ °C	Recommended connections
1	0.09	
2	0.36	
4	1.45	

Notes: ¹⁾ The standard configuration is with all jumpers in parallel (1 primary turn) which is the only one calibrated and guaranteed by LEM. The sensitivity may change slightly for all other configurations, therefore, LEM advises the user to characterize any specific configuration.

²⁾ The maximum magnetic offset referred to primary is inversely proportional to the number of turns, thus is divided by 2 with 2 turns and by 4 with 4 turns.

Definition of typical, minimum and maximum values

Minimum and maximum values for specified limiting and safety conditions have to be understood as such as well as values shown in "typical" graphs.

On the other hand, measured values are part of a statistical distribution that can be specified by an interval with upper and lower limits and a probability for measured values to lie within this interval.

Unless otherwise stated (e.g. "100 % tested"), the LEM definition for such intervals designated with "min" and "max" is that the probability for values of samples to lie in this interval is 99.73 %.

For a normal (Gaussian) distribution, this corresponds to an interval between -3 sigma and +3 sigma. If "typical" values are not obviously mean or average values, those values are defined to delimit intervals with a probability of 68.27 %, corresponding to an interval between -sigma and +sigma for a normal distribution.

Typical, maximal and minimal values are determined during the initial characterization of the product.

Remark

Installation of the transducer must be done unless otherwise specified on the datasheet, according to LEM Transducer Generic Mounting Rules. Please refer to LEM document N°ANE120504 available on our Web site: [Products/Product Documentation](#).

PCB Footprint (in mm, general tolerance ± 0.3 mm)

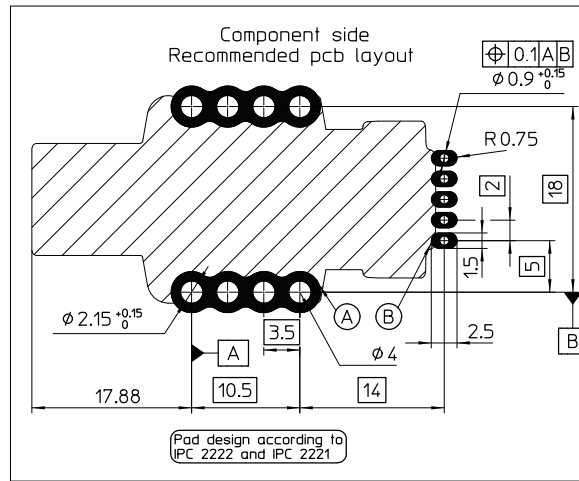

(Layout example with 4 jumpers in parallel)

Assembly on PCB

- Recommended PCB hole diameter 2.15 mm for primary pin
 0.9 mm for secondary pin
- Maximum PCB thickness 2.4 mm
- Wave soldering profile maximum 260 °C, 10 s
 No clean process only

Insulation distance (nominal values):

	d_{Cp}	d_{Cl}
On PCB: A - B	11.65 mm	-
Between jumper and secondary terminal	13.08 mm	13.65 mm
Between core and PCBA	13.56 mm	-

Safety

This transducer must be used in limited-energy secondary circuits according to IEC 61010-1.



This transducer must be used in electric/electronic equipment with respect to applicable standards and safety requirements in accordance with the manufacturer's operating instructions.



Caution, risk of electrical shock.

When operating the transducer, certain parts of the module can carry hazardous voltage (e.g. primary bus bar, power supply). Ignoring this warning can lead to injury and/or cause serious damage.

This transducer is a build-in device, whose conducting parts must be inaccessible after installation.

A protective housing or additional shield could be used.

Main supply must be able to be disconnected.

Dimensions HO-NP series (in mm, general linear tolerance ± 0.3 mm)

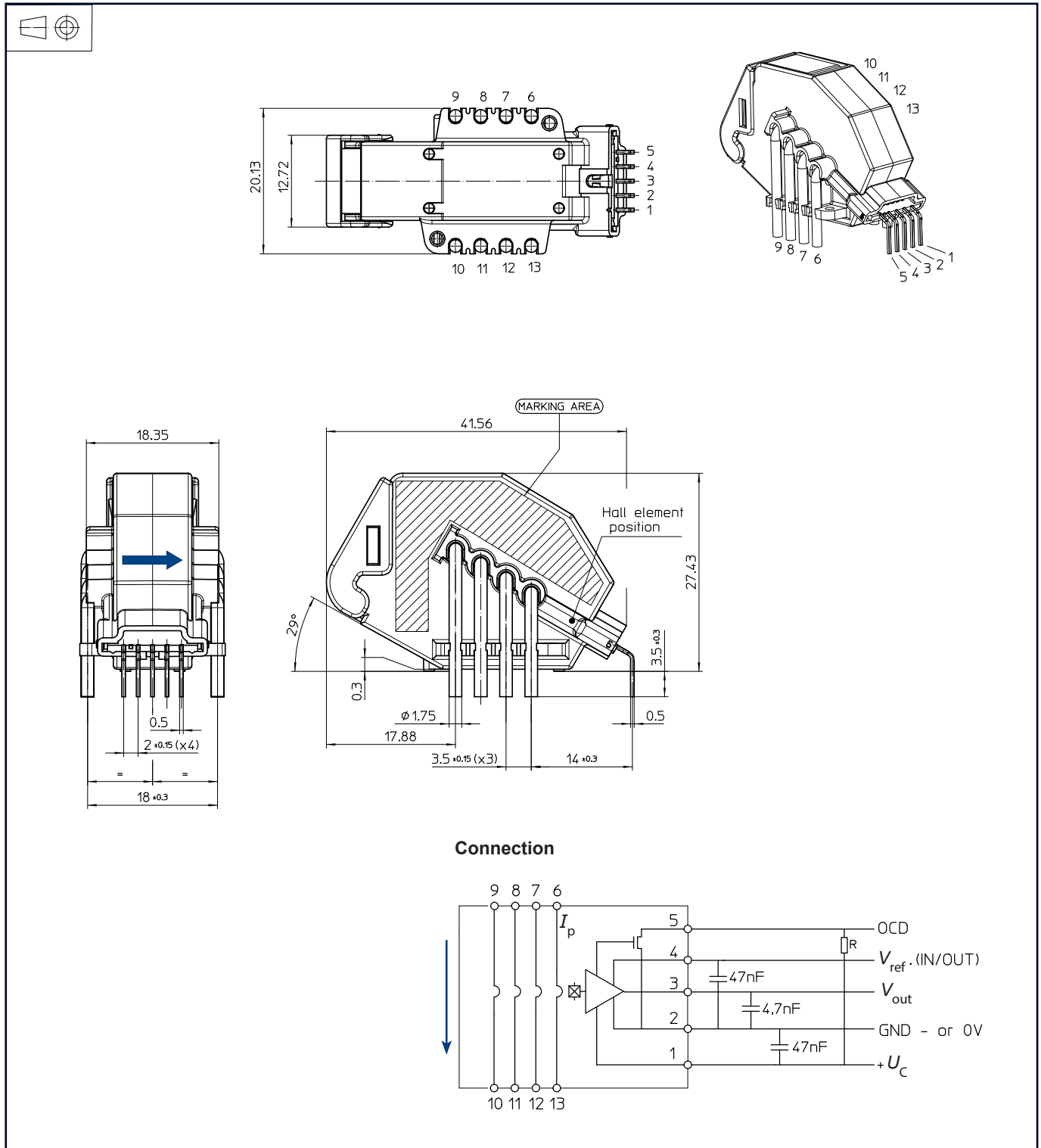

Remark:

- V_{OUT} is positive with respect to V_{ref} when positive I_p flows in direction of the arrow shown on the drawing above.

X-ON Electronics

Largest Supplier of Electrical and Electronic Components

Click to view similar products for [Lem manufacturer](#):

Other Similar products are found below :

[FHS 40-P KIT 4-1P](#) [FHS 40-P KIT 7-1P](#) [AT5B420L](#) [DHR 400 C10](#) [ATO-60-B225-D10](#) [IT 405-S](#) [ULTRASTAB](#) [HAS50-S/SP50](#) [CASR15-NP](#) [LA125-P](#) [RT 500](#) [FHS 40-P KIT 9-1P](#) [LF 205-S](#) [DVL 500](#) [DVL 750](#) [DVL 1000-UI](#) [AT100B10](#) [DIN RAIL ADAPTER ATO-D10](#) [DIN RAIL ADAPTER ATO-D16](#) [HO 200-/SP30](#) [AT150B420L](#) [DHR 100 C420](#) [HAIS 150-P](#) [AT 10 B10](#) [HO 150-/SP30](#) [DVL 1500-UI](#) [APR 50 B10](#) [DVL 750-UI](#) [HO 40-NP-0100](#) [CASR6-NP](#) [LAH100-P](#) [DHAB S/118](#) [LF205-S](#) [HO 250-/SP30](#) [LF 210-S](#) [hat800-s](#) [HAT400-S](#) [ART-B22-D070](#) [HO 50-S/SP33-1106](#) [RT 2000](#) [HX 03-P/SP2](#) [HTFS 400-P/SP2](#) [AP 50 B10](#) [DVL 2000](#) [HO 60-NP](#) [AP 50 B420L](#) [DVL 1500](#) [CAS25-NP](#) [DHR 200 C420](#) [HO 180-P](#) [HY 25-P](#)