

3 - DISCONNECTS

MALE & FEMALE DISCONNECTS



Non-Insulated	52
Vinyl Insulated	54
PC Insulated	57

NYLON COUPLAR SETS [58](#)



PIGGYBACK DISCONNECTS [59](#)



KNIFE DISCONNECTS [60](#)

FEMALE FLAG DISCONNECTS [61](#)



MALE BULLETS AND FEMALE RECEPTACLES



Vinyl Insulated	62
Nylon Insulated	64

OPEN BARREL MALE & FEMALE DISCONNECTS [65](#)



SPECIALTY CONNECTORS



Double Male and Female	66
Quick Tap Splices	66



INSULATING SLEEVES [67](#)



Disconnects

Non-Insulated Female Disconnects

Material: Tin Plated Brass

Temperature: 300°F

Maximum Electrical Rating: 22-16: 10 Amps
 16-14: 15 Amps
 12-10: 24 Amps

Barrel ID (d1): .067
Barrel ID (d1): .091
Barrel ID (d1): .134

T= Material Thickness

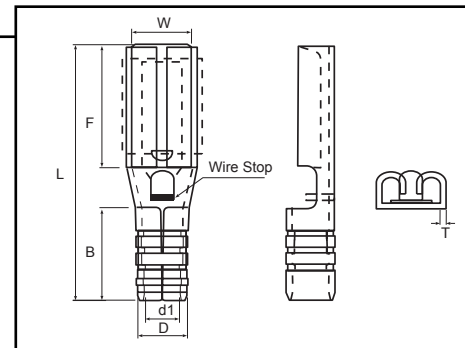

HOFFMAN PART NO.	WIRE SIZE	TAB	DIMENSIONS (INCHES)							UL	TAPE MOUNTED REEL QTY	DIE FOR TAPE MOUNT	HAND TOOL
			W	F	L	B	D	T					
DF2216T110A5	22-16	.110 x .020	0.126	0.256	0.535	0.189	0.106	0.012	N	1000	3Q2216	YHM228	
DF2216T110A8	22-16	.110 x .032	0.126	0.256	0.535	0.189	0.106	0.012	N	1000	3Q2216	YHM228	
DF2216T187A5	22-16	.187 x .020	0.199	0.248	0.543	0.189	0.106	0.014	N	1000	3Q2216	YHM228	
DF2216T187A5/J	22-16	.187 x .020	0.197	0.236	0.560	0.195	0.106	0.014	Y	1000	3Q2216	YHT2210	
DF2216T187A8	22-16	.187 x .032	0.199	0.248	0.543	0.189	0.106	0.014	N	1000	3Q2216	YHM228	
DF2216T187A8/J	22-16	.187 x .032	0.197	0.236	0.560	0.195	0.106	0.014	Y	1000	3Q2216	YHT2210	
DF2216T250A	22-16	.250 x .032	0.260	0.287	0.598	0.189	0.106	0.016	N	1000	3Q2216	YHM228	
DF2216T250A/J	22-16	.250 x .032	0.260	0.307	0.630	0.195	0.106	0.016	Y	1000	3Q2216	YHT2210	
DF1614T187A5	16-14	.187 x .020	0.200	0.248	0.543	0.189	0.130	0.014	N	1000	3Q1614	YHM228	
DF1614T187A5/J	16-14	.187 x .020	0.197	0.236	0.560	0.195	0.130	0.014	Y	1000	3Q1614	YHT2210	
DF1614T187A8	16-14	.187 x .032	0.199	0.252	0.543	0.189	0.130	0.014	N	1000	3Q1614	YHM228	
DF1614T250A	16-14	.250 x .032	0.260	0.287	0.598	0.189	0.130	0.016	N	1000	3Q1614	YHM228	
DF1614T250A/J	16-14	.250 x .032	0.260	0.307	0.630	0.195	0.130	0.016	Y	1000	3Q1614	YHT2210	
DF1210T250A	12-10	.250 x .032	0.260	0.287	0.638	0.228	0.177	0.016	N	500	3Q1210	YHM228	
DF1210T250A/J	12-10	.250 x .032	0.260	0.307	0.670	0.135	0.177	0.016	Y	500	3Q1210	YHT2210	

Non-Insulated Female Disconnect with Copper Support Sleeve

Material: Tin Plated Brass with Tin Plated Copper Support Sleeve
Temperature: 300°F

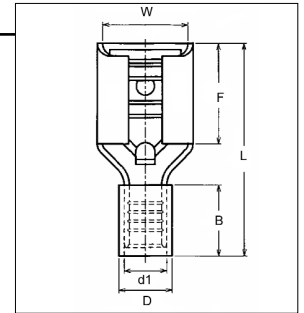

T = Material Thickness

HOFFMAN PART NO.	WIRE SIZE	TAB	DIMENSIONS (INCHES)							UL	TAPE MOUNTED REEL QTY	DIE FOR TAPE MOUNT	HAND TOOL
			W	F	L	B	D	T					
DDF2216T110A5/J	22-16	.110 x .020	0.126	0.252	0.577	0.232	0.114	0.016	Y	NA	NA	YDT2216	
DDF2216T110A8/J	22-16	.110 x .032	0.126	0.252	0.577	0.232	0.114	0.016	Y	NA	NA	YDT2216	
DDF2216T187A5/J	22-16	.187 x .020	0.197	0.236	0.597	0.232	0.114	0.016	Y	NA	NA	YDT2216	
DDF2216T187A8/J	22-16	.187 x .032	0.197	0.236	0.597	0.232	0.114	0.016	Y	NA	NA	YDT2216	
DDF2216T250A/J	22-16	.250 x .032	0.260	0.307	0.667	0.232	0.114	0.016	Y	NA	NA	YDT2216	
DDF1614T187A55.9/J	16-14	.187 x .020	0.197	0.236	0.597	0.232	0.138	0.016	Y	NA	NA	YDT1614	
DDF1614T187A85.9/J	16-14	.187 x .032	0.197	0.236	0.597	0.232	0.138	0.016	Y	NA	NA	YDT1614	
DDF1614T250A5.9/J	16-14	.250 x .032	0.260	0.307	0.667	0.232	0.138	0.016	Y	NA	NA	YDT1614	
DDF1210T250A6.9/J	12-10	.250 x .032	0.260	0.307	0.707	0.272	0.185	0.016	Y	NA	NA	YDT1210	

Non-Insulated Male Disconnects

Material: Tin Plated Brass
Temperature: 300°F
Maximum Electrical Rating: 22-16: 10 Amps
 16-14: 15 Amps
 12-10: 24 Amps

Barrel ID (d1): .067
Barrel ID (d1): .091
Barrel ID (d1): .134

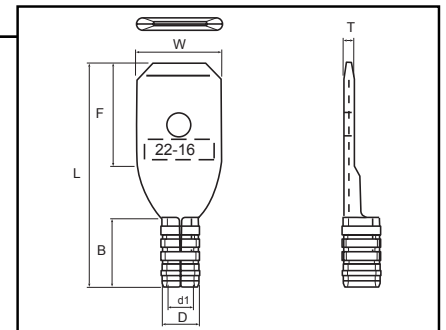

T = Material Thickness

HOFFMAN PART NO.	WIRE SIZE	TAB	DIMENSIONS (INCHES)							UL	TAPE MOUNT REEL QTY	DIE FOR TAPE MOUNT	HAND TOOL
			W	F	L	B	D	T					
DM2216T187A5	22-16	.187 X .020	0.189	0.256	0.551	0.189	0.106	0.020	N	1000	3Q2216	YHM228	
DM2216T187A8	22-16	.187 X .032	0.189	0.264	0.551	0.189	0.106	0.016	N	1000	3Q2216	YHM228	
DM2216T250	22-16	.250 x .032	0.248	0.299	0.646	0.189	0.106	0.016	N	1000	3Q2216	YHM228	
DM1614T187A5	16-14	.187 X .020	0.189	0.256	0.551	0.189	0.130	0.020	N	1000	3Q1614	YHM228	
DM1614T187A8	16-14	.187 X .032	0.189	0.256	0.551	0.189	0.130	0.016	N	1000	3Q1614	YHM228	
DM1614T250	16-14	.250 x .032	0.248	0.299	0.646	0.189	0.130	0.016	N	1000	3Q1614	YHM228	
DM1210T250	12-10	.250 x .032	0.248	0.303	0.748	0.189	0.177	0.016	N	1000	3Q1210	YHM228	



Non-Insulated Male Disconnect with Copper Support Sleeve

Material: Tin Plated Brass with Tin Plated Copper Support Sleeve

Temperature: 300°F

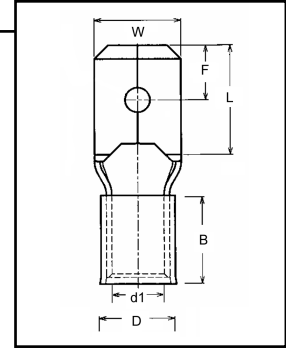

T= Material Thickness

HOFFMAN PART NO.	WIRE SIZE	TAB	DIMENSIONS (INCHES)							UL	TAPE MOUNT REEL QTY	DIE FOR TAPE MOUNT	HAND TOOL
			W	F	L	B	D	T					
DDM2216T2505.9/J	22-16	.250 x .032	0.248	0.315	0.650	0.195	0.114	0.016	Y	NA	NA	YDT2216	
DDM1614T2505.9/J	16-14	.250 x .032	0.248	0.315	0.650	0.195	0.138	0.016	Y	NA	NA	YDT1614	
DDM1210T2506.9/J	12-10	.250 x .032	0.248	0.315	0.748	0.235	0.185	0.016	Y	NA	NA	YDT1210	

Vinyl Insulated Disconnects

Vinyl Insulated Female Disconnect

Material: Tin Plated Brass

Insulation Material: Vinyl

Maximum Electrical Rating: 75°C, 300V

Maximum Electrical Current: 22-16: 10 Amps
16-14: 15 Amps
12-10: 24 Amps

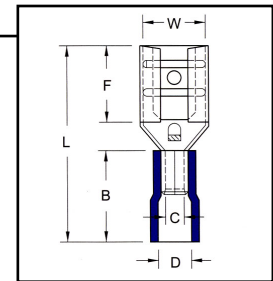

T= Material Thickness

HOFFMAN PART NO.	WIRE SIZE	TAB	DIMENSIONS (INCHES)							UL	TAPE MOUNT REEL QTY	DIE FOR TAPE MOUNT	HAND TOOL
			W	F	L	B	D	T					
FVDF2216T110A5	22-16	.110 x .020	0.126	0.256	0.732	0.394	0.157	0.012	Y	1000	3F2216	YNM2210C	
FVDF2216T110A8	22-16	.110 x .032	0.125	0.256	0.732	0.394	0.157	0.012	Y	1000	3F2216	YNM2210C	
FVDF2216T187A5	22-16	.187 x .020	0.197	0.252	0.748	0.394	0.157	0.014	Y	1000	3F2216	YNM2210C	
FVDF2216T187A8	22-16	.187 x .032	0.197	0.252	0.748	0.394	0.157	0.014	Y	1000	3F2216	YNM2210C	
FVDF2216T250A	22-16	.250 x .032	0.260	0.295	0.807	0.394	0.157	0.016	Y	1000	3F2216	YNM2210C	
FVDF1614T187A5	16-14	.187 x .020	0.197	0.252	0.748	0.394	0.177	0.014	Y	1000	3F1614	YNM2210C	
FVDF1614T187A8	16-14	.187 x .032	0.197	0.252	0.748	0.394	0.177	0.014	Y	1000	3F1614	YNM2210C	
FVDF1614T250A	16-14	.250 x .032	0.260	0.295	0.807	0.394	0.177	0.016	Y	1000	3F1614	YNM2210C	
FVDF1614T250A/J	16-14	.250 x .032	0.260	0.307	0.807	0.374	0.169	0.016	Y	1000	3F1614	YNT1614	
FVDF1210T250A	12-10	.250 x .032	0.260	0.295	0.925	0.512	0.512	0.016	Y	500	3F1210	YNM2210C	
FVDF1210T250A/J	12-10	.250 x .032	0.260	0.307	0.965	0.532	0.244	0.016	Y	500	3F1210	YNT1210S	

Vinyl Insulated Male Disconnect

Material: Tin Plated Brass

Insulation Material: Vinyl

Maximum Electrical Rating: 75°C, 300V

Maximum Electrical Current: 22-16: 10 Amps
 16-14: 15 Amps
 12-10: 24 Amps

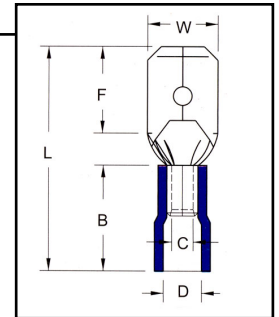

T= Material Thickness

HOFFMAN PART NO.	WIRE SIZE	TAB	DIMENSIONS (INCHES)							T	UL	TAPE MOUNT REEL QTY	DIE FOR TAPE MOUNT	HAND TOOL
			W	F	L	B	D							
FVDM2216T110A5	22-16	.110 x .020	0.110	0.256	0.728	0.394	0.157	0.020	Y	1000	3F2216	YNM2210C		
FVDM2216T110A8	22-16	.110 x .032	0.110	0.256	0.728	0.394	0.157	0.016	Y	1000	3F2216	YNM2210C		
FVDM2216T187A5	22-16	.187 x .020	0.189	0.256	0.748	0.394	0.157	0.020	Y	1000	3F2216	YNM2210C		
FVDM2216T187A8	22-16	.187 x .032	0.189	0.264	0.748	0.394	0.157	0.016	Y	1000	3F2216	YNM2210C		
FVDM2216T250	22-16	.250 x .032	0.250	0.303	0.827	0.394	0.157	0.016	Y	1000	3F2216	YNM2210C		
FVDM1614T187A5	16-14	.187 x .020	0.189	0.256	0.748	0.394	0.177	0.020	Y	1000	3F1614	YNM2210C		
FVDM1614T187A8	16-14	.187 x .032	0.189	0.264	0.748	0.394	0.177	0.016	Y	1000	3F1614	YNM2210C		
FVDM1614T250	16-14	.250 x .032	0.250	0.303	0.827	0.394	0.177	0.016	Y	1000	3F1614	YNM2210C		
FVDM1210T250	12-10	.250 x .032	0.250	0.303	0.945	0.512	0.217	0.016	Y	500	3F1210	YNM2210C		
FVDM1210T250/J	12-10	.250 x .032	0.248	0.335	0.965	0.531	0.244	0.016	Y	500	3F1210	YNT1210S		

Vinyl Insulated Female Disconnect with Support Sleeve

Material: Tin Plated Brass

Insulation Material: Vinyl

Maximum Electrical Rating: 75°C, 300V

Maximum Electrical Current: 22-16: 10 Amps
 16-14: 15 Amps
 12-10: 24 Amps

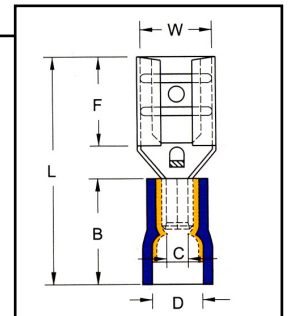

T= Material Thickness

HOFFMAN PART NO.	WIRE SIZE	TAB	DIMENSIONS (INCHES)							T	UL	TAPE MOUNT REEL QTY	DIE FOR TAPE MOUNT	HAND TOOL
			W	F	L	B	D							
FVHDF2216T110A5	22-16	.110 x .020	0.126	0.256	0.748	0.413	0.150	0.012	Y	1000	3V2216	YNM2210D		
FVHDF2216T110A8	22-16	.110 x .032	0.126	0.256	0.748	0.413	0.150	0.012	Y	1000	3V2216	YNM2210D		
FVHDF2216T187A5	22-16	.187 x .020	0.197	0.252	0.764	0.413	0.150	0.014	Y	1000	3V2216	YNM2210D		
FVHDF2216T187A8	22-16	.187 x .032	0.197	0.252	0.764	0.413	0.150	0.014	Y	1000	3V2216	YNM2210D		
FVHDF2216T250A	22-16	.250 x .032	0.260	0.295	0.819	0.413	0.150	0.016	Y	1000	3V2216	YNM2210D		
FVHDF1614T110A5	16-14	.110 x .020	0.126	0.256	0.748	0.413	0.185	0.012	Y	1000	3V1614	YNM2210D		
FVHDF1614T110A8	16-14	.110 x .032	0.126	0.256	0.748	0.413	0.185	0.012	Y	1000	3V1614	YNM2210D		
FVHDF1614T187A5	16-14	.187 x .020	0.197	0.252	0.764	0.413	0.185	0.014	Y	1000	3V1614	YNM2210D		
FVHDF1614T187A8	16-14	.187 x .032	0.197	0.252	0.764	0.413	0.185	0.014	Y	1000	3V1614	YNM2210D		
FVHDF1614T250A	16-14	.250 x .032	0.260	0.297	0.819	0.413	0.185	0.016	Y	1000	3V1614	YNM2210D		
FVDDF1210T250A	12-10	.250 x .032	0.260	0.295	0.917	0.512	0.244	0.016	Y	500	3V1210	YNM2210D		
FVDDF1210T250A/J	12-10	.250 x .032	0.291	0.307	0.965	0.531	0.244	0.016	Y	500	3V1210	YNT1210S		



Vinyl Insulated Male Disconnect with Support Sleeve

Material: Tin Plated Brass

Insulation Material: Vinyl

Maximum Electrical Rating: 75°C, 300V

Maximum Electrical Current: 22-16: 10 Amps
 16-14: 15 Amps
 12-10: 24 Amps

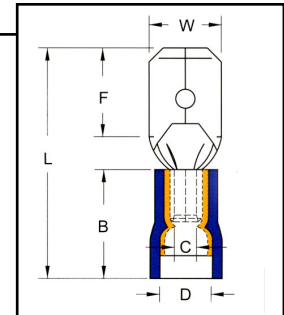

T= Material Thickness

HOFFMAN PART NO.	WIRE SIZE	TAB	DIMENSIONS (INCHES)							UL	TAPE MOUNT REEL QTY	DIE FOR TAPE MOUNT	HAND TOOL
			W	F	L	B	D	T					
FVDDM2216T250	22-16	.250 x .032	0.250	0.303	0.858	0.413	0.150	0.016	Y	1000	3V2216	YNM2210D	
FVDDM1614T250	16-14	.250 x .032	0.250	0.303	0.858	0.413	0.185	0.016	Y	1000	3V1614	YNM2210D	
FVDDM1614T250/J	16-14	.250 x .032	0.248	0.315	0.807	0.374	0.169	0.016	Y	1000	3V1614	YNT1614	
FVDDM1210T250	12-10	.250 x .032	0.250	0.303	0.945	0.512	0.244	0.016	Y	500	3V1210	YNM2210D	

Fully Vinyl Insulated Female Disconnect with Support Sleeve

Material: Tin Plated Brass

Insulation Material: Vinyl

Maximum Electrical Rating: 75°C, 300V

Maximum Electrical Current: 22-16: 10 Amps
 16-14: 15 Amps
 12-10: 24 Amps

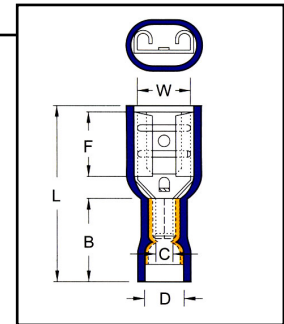

T= Material Thickness

HOFFMAN PART NO.	WIRE SIZE	TAB	DIMENSIONS (INCHES)							UL	TAPE MOUNT REEL QTY	DIE FOR TAPE MOUNT	HAND TOOL
			W	F	L	B	D	T					
LVDHF2216T110A5	22-16	.110 X .020	0.126	0.256	0.748	0.413	0.150	0.012	Y	500	3V2216	YNM2210D	
LVDHF2216T110A8	22-16	.110 X .032	0.126	0.256	0.748	0.413	0.150	0.012	Y	500	3V2216	YNM2210D	
LVDHF2216T187A5	22-16	.187 x .020	0.197	0.252	0.807	0.413	0.150	0.014	Y	500	3V2216	YNM2210D	
LVDHF2216T187A8	22-16	.187 x .032	0.197	0.252	0.807	0.413	0.150	0.014	Y	500	3V2216	YNM2210D	
LVDHF2216T187A8/J	22-16	.187 x .032	0.224	0.236	0.807	0.433	0.142	0.014	Y	500	3V2216	YNT2216	
LVDHF2216T250A	22-16	.250 x .032	0.260	0.295	0.858	0.413	0.150	0.016	Y	500	3V2216	YNM2210D	
LVDHF1614T110A5	16-14	.110 X .020	0.126	0.256	0.748	0.413	0.185	0.012	Y	500	3V1614	YNM2210D	
LVDHF1614T110A8	16-14	.110 X .032	0.126	0.256	0.748	0.413	0.185	0.012	Y	500	3V1614	YNM2210D	
LVDHF1614T187A5	16-14	.187 x .020	0.197	0.252	0.795	0.413	0.185	0.014	Y	500	3V1614	YNM2210D	
LVDHF1614T187A8	16-14	.187 x .032	0.197	0.252	0.795	0.413	0.185	0.014	Y	500	3V1614	YNM2210D	
LVDHF1614T250A	16-14	.250 x .032	0.260	0.295	0.874	0.413	0.185	0.016	Y	500	3V1614	YNM2210D	
LVDDF1210T250A	12-10	.250 x .032	0.260	0.295	0.953	0.492	0.244	0.016	Y	500	3V1210	YNM2210D	
LVDDF1210T250A/J	12-10	.250 x .032	0.291	0.307	0.984	0.551	0.177	0.016	Y	500	3V1210	YNT1210S	



PC Insulated Disconnects

PC Insulated Female Disconnect with Support Sleeve

Material: Tin Plated Brass with Copper Support Sleeve

Insulation Material: PC Insulated

Maximum Electrical Rating: 125°C, 600V

Maximum Electrical Current: 22-16: 10 Amps **Barrel ID (d1):** 0.067
 16-14: 15 Amps **Barrel ID (d1):** 0.091
 12-10: 24 Amps **Barrel ID (d1):** 0.134

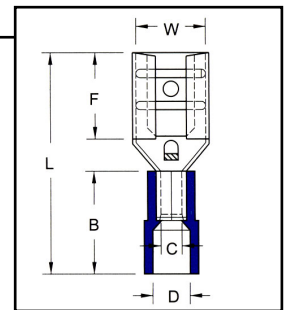

T= Material Thickness

HOFFMAN PART NO.	WIRE SIZE	TAB	DIMENSIONS (INCHES)							UL	TAPE MOUNT REEL QTY	DIE FOR TAPE MOUNT	HAND TOOL
			W	F	L	B	D	T					
FNDDF2216T110A5	22-16	.110 x .020	0.126	0.256	0.772	0.433	0.157	0.012	Y	1000	3V2216	YNM2210D	
FNDDF2216T110A8	22-16	.110 x .032	0.126	0.256	0.772	0.433	0.157	0.012	Y	1000	3V2216	YNM2210D	
FNDDF2216T187A5	22-16	.187 x .020	0.197	0.252	0.787	0.433	0.157	0.014	Y	1000	3V2216	YNM2210D	
FNDDF2216T187A8	22-16	.187 x .032	0.197	0.252	0.787	0.433	0.157	0.014	Y	1000	3V2216	YNM2210D	
FNDDF2216T250A	22-16	.250 x .032	0.260	0.295	0.846	0.433	0.157	0.016	Y	1000	3V2216	YNM2210D	
FNDDF1614T110A5	16-14	.110 x .020	0.126	0.256	0.772	0.433	0.197	0.012	Y	1000	3V1614	YNM2210D	
FNDDF1614T110A8	16-14	.110 x .032	0.126	0.256	0.772	0.433	0.197	0.012	Y	1000	3V1614	YNM2210D	
FNDDF1614T187A5	16-14	.187 x .020	0.197	0.252	0.787	0.433	0.197	0.014	Y	1000	3V1614	YNM2210D	
FNDDF1614T187A8	16-14	.187 x .032	0.197	0.252	0.787	0.433	0.197	0.014	Y	1000	3V1614	YNM2210D	
FNDDF1614T250A	16-14	.250 x .032	0.260	0.295	0.846	0.433	0.197	0.016	Y	1000	3V1614	YNM2210D	
FNDDF1210T187A5	12-10	.187 x .020	0.197	0.256	0.866	0.512	0.256	0.014	Y	500	3V1210	YNM2210D	
FNDDF1210T187A8	12-10	.187 x .032	0.197	0.256	0.866	0.512	0.256	0.014	Y	500	3V1210	YNM2210D	
FNDDF1210T250A	12-10	.250 x .032	0.260	0.295	0.925	0.512	0.256	0.016	Y	500	3V1210	YNM2210D	

PC Insulated Male Disconnect with Support Sleeve

Material: Tin Plated Brass with Copper Support Sleeve

Insulation Material: PC Insulated

Maximum Electrical Rating: 125°C, 600V

Maximum Electrical Current: 22-16: 10 Amps **Barrel ID (d1):** 0.067
 16-14: 15 Amps **Barrel ID (d1):** 0.091
 12-10: 24 Amps **Barrel ID (d1):** 0.134

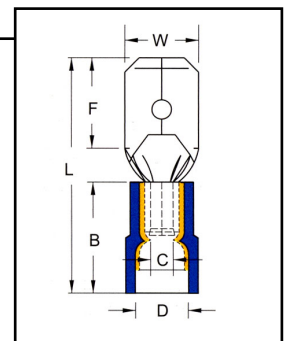

T= Material Thickness

HOFFMAN PART NO.	WIRE SIZE	TAB	DIMENSIONS (INCHES)							UL	TAPE MOUNT REEL QTY	DIE FOR TAPE MOUNT	HAND TOOL
			W	F	L	B	D	T					
FNDDM2216T110A5	22-16	.110 x .020	0.110	0.256	0.768	0.433	0.157	0.020	Y	1000	3V2216	YNM2210D	
FNDDM2216T110A8	22-16	.110 x .032	0.110	0.256	0.768	0.433	0.157	0.016	Y	1000	3V2216	YNM2210D	
FNDDM2216T187A5	22-16	.187 x .020	0.189	0.256	0.787	0.433	0.157	0.020	Y	1000	3V2216	YNM2210D	
FNDDM2216T187A8	22-16	.187 x .032	0.189	0.264	0.787	0.433	0.157	0.016	Y	1000	3V2216	YNM2210D	
FNDDM2216T250	22-16	.250 x .032	0.250	0.303	0.866	0.433	0.157	0.016	Y	1000	3V2216	YNM2210D	
FNDDM1614T187A5	16-14	.187 x .020	0.189	0.256	0.787	0.433	0.197	0.020	Y	1000	3V1614	YNM2210D	
FNDDM1614T187A8	16-14	.187 x .032	0.189	0.264	0.787	0.433	0.197	0.016	Y	1000	3V1614	YNM2210D	
FNDDM1614T250	16-14	.250 x .032	0.250	0.303	0.866	0.433	0.197	0.016	Y	1000	3V1614	YNM2210D	
FNDDM1210T250	12-10	.250 x .032	0.250	0.303	0.945	0.512	0.256	0.016	Y	500	3V1210	YNM2210D	



PC Fully Insulated Female Disconnect with Support Sleeve

Material: Tin Plated Brass with Copper Support Sleeve

Insulation Material: PC Insulated

Maximum Electrical Rating: 125°C, 600V

Maximum Electrical Current: 22-16: 10 Amps
 16-14: 15 Amps
 12-10: 24 Amps

Barrel ID (d1): 0.067
Barrel ID (d1): 0.091
Barrel ID (d1): 0.134

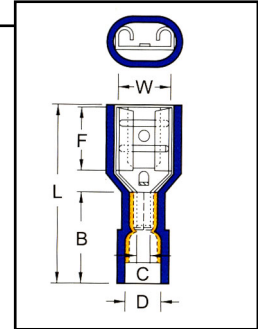

T= Material Thickness

HOFFMAN PART NO.	WIRE SIZE	TAB	DIMENSIONS (INCHES)							UL	TAPE MOUNT REEL QTY	DIE FOR TAPE MOUNT	HAND TOOL
			W	F	L	B	D	T					
LNDDF2216T110A5	22-16	.110 x .020	0.126	0.256	0.768	0.433	0.157	0.012	Y	500	3V2216	YNM2210D	
LNDDF2216T110A8	22-16	.110 x .032	0.126	0.256	0.768	0.433	0.157	0.012	Y	500	3V2216	YNM2210D	
LNDDF2216T187A5	22-16	.187 x .020	0.197	0.252	0.795	0.433	0.157	0.014	Y	500	3V2216	YNM2210D	
LNDDF2216T187A8	22-16	.187 x .032	0.197	0.252	0.795	0.433	0.157	0.014	Y	500	3V2216	YNM2210D	
LNDDF2216T250A	22-16	.250 x .032	0.260	0.295	0.846	0.433	0.157	0.016	Y	500	3V2216	YNM2210D	
LNDDF1614T187A5	16-14	.187 x .020	0.197	0.252	0.795	0.433	0.197	0.016	Y	500	3V1614	YNM2210D	
LNDDF1614T187A8	16-14	.187 x .032	0.197	0.252	0.795	0.433	0.197	0.016	Y	500	3V1614	YNM2210D	
LNDDF1614T250A	16-14	.250 x .032	0.260	0.295	0.846	0.433	0.197	0.016	Y	500	3V1614	YNM2210D	
LNDDF1210T250A	12-10	.250 x .032	0.260	0.295	0.953	0.512	0.256	0.016	Y	500	3V1210	YNM2210D	

Nylon Couplars Sets

Nylon Fully Insulated Couplars

Material: Tin Plated Brass

Insulation Material: UL94V2 6/6 Nylon

Maximum Electrical Rating: 105°C, 300V

Maximum Electrical Current: 22-16: 10 Amps
 16-14: 15 Amps
 12-10: 24 Amps

Barrel ID (d1): 0.067
Barrel ID (d1): 0.091
Barrel ID (d1): 0.134

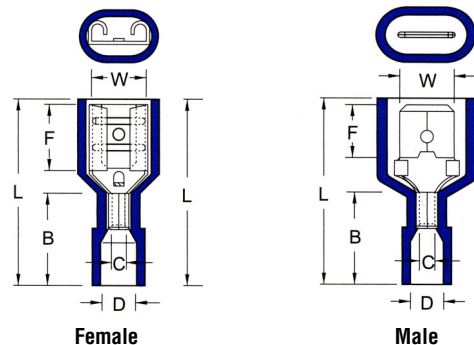

T= Material Thickness

HOFFMAN PART NO.	WIRE SIZE	TAB	DIMENSIONS (INCHES)							UL	TAPE MOUNT REEL QTY	DIE FOR TAPE MOUNT	HAND TOOL
			W	F	L	B	D	T					
FEMALE													
LNDF2216250H	22-16	.250 x .032	0.260	0.295	0.866	0.433	0.157	0.016	Y	500	3F2216	YNM2210C	
LNDF1614250H	16-14	.250 x .032	0.260	0.295	0.866	0.433	0.177	0.016	Y	500	3F1614	YNM2210C	
LNDF1210250H	12-10	.250 x .032	0.260	0.295	0.945	0.512	0.248	0.016	Y	500	3F1210	YNM2210C	
MALE													
LNDM2216250H	22-16	.250 x .032	0.250	0.303	0.945	0.433	0.157	0.016	Y	500	3F2216	YNM2210C	
LNDM1614250H	16-14	.250 x .032	0.250	0.303	0.906	0.433	0.177	0.016	Y	500	3F1614	YNM2210C	
LNDM1210250H	12-10	.250 x .032	0.250	0.303	0.984	0.512	0.248	0.016	Y	500	3F1210	YNM2210C	



Piggyback Connectors

Non-Insulated Piggyback Connectors

Material: Tin Plated Brass

Temperature: 300°F

Maximum Electrical Current: 22-16: 10 Amps
 16-14: 15 Amps
 12-10: 24 Amps

Barrel ID (d1): 0.067
Barrel ID (d1): 0.091
Barrel ID (d1): 0.134

T= Material Thickness

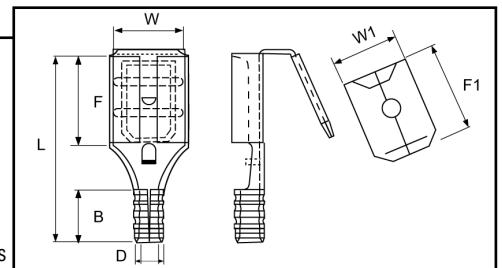

HOFFMAN PART NO.	WIRE SIZE	TAB	DIMENSIONS (INCHES)									UL	TAPE MOUNT REEL QTY	DIE FOR TAPE MOUNT	HAND TOOL
			W	W1	F	F1	L	B	D	T					
DFM2216T250A	22-16	.250 x .032	.260	.250	.315	.232	.630	.189	.106	.031	N	NA	NA	YHM228	
DFM1614T250A	16-14	.250 x .032	.260	.250	.315	.323	.598	.189	.130	.031	N	NA	NA	YHM228	

Vinyl Insulated Piggyback Connectors

Material: Tin Plated Brass

Insulation Material: Vinyl

Maximum Electrical Rating: 75°C, 300V

Maximum Electrical Current: 22-16: 10 Amps
 16-14: 15 Amps
 12-10: 24 Amps

Barrel ID (d1): 0.067
Barrel ID (d1): 0.091
Barrel ID (d1): 0.134

T= Material Thickness

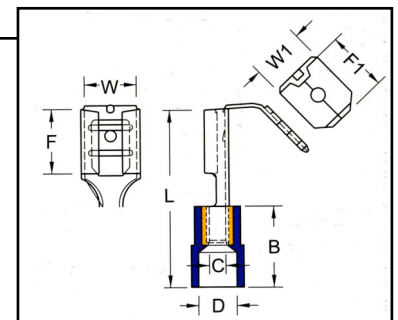

HOFFMAN PART NO.	WIRE SIZE	TAB	DIMENSIONS (INCHES)									UL	TAPE MOUNT REEL QTY	DIE FOR TAPE MOUNT	HAND TOOL
			W	W1	F	F1	L	B	D	T					
FVDFM2216T250A	22-16	.250 x .032	.260	.250	0.315	0.323	0.866	0.394	0.157	0.016	N	NA	NA	YNM2210C	
FVDFM1614T250A	16-14	.250 x .032	.260	.250	0.315	0.323	0.866	0.394	0.177	0.016	N	NA	NA	YNT1614	
FVDFM1614T250A/J	16-14	.250 x .032	.268	.248	0.307	0.315	0.875	0.374	0.169	0.016	Y	NA	NA	YNM2210C	
FVDFM1210T250A	12-10	.250 x .032	.260	.250	0.315	0.323	0.945	0.512	0.217	0.016	N	NA	NA	YNM2210C	

Vinyl Insulated Piggyback with Support Sleeve

Material: Tin Plated Brass

Insulation Material: Vinyl

Maximum Electrical Rating: 75°C, 300V

Maximum Electrical Current: 22-16: 10 Amps
 16-14: 15 Amps
 12-10: 24 Amps

Barrel ID (d1): 0.067
Barrel ID (d1): 0.091
Barrel ID (d1): 0.134

T= Material Thickness

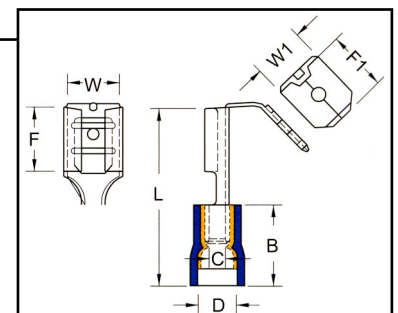

HOFFMAN PART NO.	WIRE SIZE	TAB	DIMENSIONS (INCHES)									UL	TAPE MOUNT REEL QTY	DIE FOR TAPE ON REEL	HAND TOOL
			W	W1	F	F1	L	B	D	T					
FVDDFM2216T250A	22-16	.250 x .032	.260	.250	0.315	0.323	0.886	0.413	0.150	0.016	Y	NA	NA	YNM2210D	
FVDDFM1614T250A	16-14	.250 x .032	.260	.250	0.315	0.323	0.886	0.413	0.185	0.016	Y	NA	NA	YNM2210D	
FVDDFM1210T250A	12-10	.250 x .032	.260	.250	0.315	0.323	0.945	0.512	0.244	0.016	Y	NA	NA	YNM2210D	



Nylon Insulated Piggyback with Support Sleeve

Material: Tin Plated Brass
Insulation Material: 6/6 UL94V2 Nylon
Maximum Electrical Rating: 105°C, 300V
Maximum Electrical Current: 22-16: 10 Amps
 16-14: 15 Amps
 12-10: 24 Amps

Barrel ID (d1): 0.067
Barrel ID (d1): 0.091
Barrel ID (d1): 0.134

T= Material Thickness

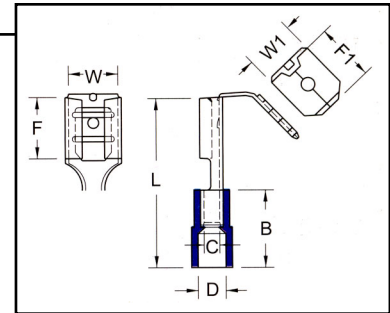

HOFFMAN PART NO.	WIRE SIZE	TAB	DIMENSIONS (INCHES)								T	TAPES	DIE FOR MOUNT REEL QTY	HAND TAPE MOUNT	TOOL
			W	W1	F	F1	L	B	D	D					
FNDDFM2216T250A	22-16	.250 x .032	0.260	0.250	0.315	0.323	0.906	0.433	0.157	0.016	Y	NA	NA	YNM2210D	
FNDDFM1614T250A	16-14	.250 x .032	0.260	0.250	0.315	0.323	0.906	0.433	0.197	0.016	Y	NA	NA	YNM2210D	
FNDDFM1210T250A	12-10	.250 x .032	0.260	0.250	0.315	0.323	0.945	0.512	0.256	0.016	Y	NA	NA	YNM2210D	

Knife Disconnects

Vinyl Insulated Knife Disconnects

Material: Tin Plated Brass
Insulation Material: Vinyl
Maximum Electrical Rating: 75°C, 300V

T= Material Thickness

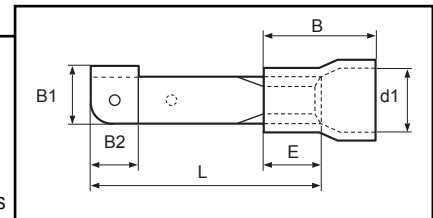

HOFFMAN PART NO.	WIRE SIZE	TAB	DIMENSIONS (INCHES)							T	UL	TAPES	DIE FOR TAPE MOUNT	HAND TOOL
			L	E	B1	B2	B	D	D					
FV2216K/J	22-16	NA	0.673	0.189	0.197	0.161	0.354	0.157	0.031	NA	NA	NA	YHM228	
FV1614K/J	16-14	NA	0.717	0.173	0.197	0.154	0.354	0.177	0.031	NA	NA	NA	YHM228	
FV1210K/J	12-10	NA	0.917	0.244	0.280	0.220	0.531	0.268	0.039	NA	NA	NA	YHM228	



Female Flag Disconnects

Non-Insulated Female Flag Disconnects

Material: Tin Plated Brass

Temperature: 300°F

Maximum Electrical Current: 22-16: 10 Amps **Barrel ID (d1):** 0.067
 16-14: 15 Amps **Barrel ID (d1):** 0.091
 12-10: 24 Amps **Barrel ID (d1):** 0.134

T = Material Thickness

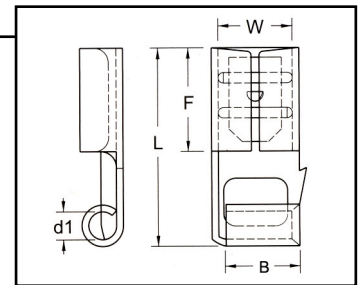

HOFFMAN PART NO.	WIRE SIZE	TAB	DIMENSIONS (INCHES)					UL	TAPE ON MOUNT REEL QTY	HAND TOOL
			W	F	L	B	T			
DF22181ST5	22-18	.187 x .020	.197	0.244	0.445	0.217	0.016	NA	NA	FG6100
DF22181ST8	22-18	.187 x .032	.197	0.244	0.445	0.217	0.016	NA	NA	FG6100
DF22181T	22-18	.250 x .032	.26	0.299	0.551	0.291	0.016	NA	NA	FG6100
DF18141ST5	16-14	.187 x .020	.197	0.244	0.457	0.217	0.016	NA	NA	FG6100
DF18141ST8	16-14	.187 x .032	.197	0.244	0.457	0.217	0.016	NA	NA	FG6100
DF18141T	16-14	.250 x .032	.26	0.299	0.551	0.291	0.016	NA	NA	FG6100
DF12101T	12-10	.250 x .032	.26	0.299	0.571	0.295	0.016	NA	NA	FG6100

Nylon Insulated Female Flag Disconnects

Material: Tin Plated Brass

Insulation Material: 6/6 UL94V2 Nylon

Maximum Electrical Rating: 105°C, 300V

Maximum Electrical Current: 22-16: 10 Amps **Barrel ID (d1):** 0.067
 16-14: 15 Amps **Barrel ID (d1):** 0.091
 12-10: 24 Amps **Barrel ID (d1):** 0.134

T = Material thickness

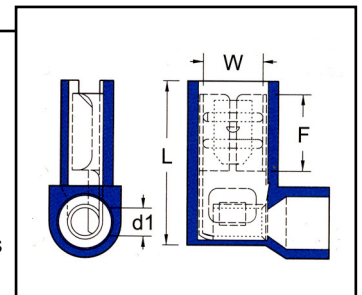

HOFFMAN PART NO.	WIRE SIZE	TAB	DIMENSIONS (INCHES)					UL	TAPE MOUNT REEL QTY	DIE FOR SCT70MS MOUNT	HAND TOOL
			W	F	L	T	UL				
FNDF22181ST5	22-18	.187 x .020	0.197	0.276	0.591	0.016	Y	1000	AFNDF2DIE	YNG2214	
FNDF22181ST8	22-18	.187 x .032	0.197	0.276	0.591	0.016	Y	1000	AFNDF2DIE	YNG2214	
FNDF22181T	22-18	.250 x .032	0.260	0.299	0.598	0.016	Y	1000	AFNDF2DIE	YNG2214	
FNDF18141ST5	16-14	.187 x .020	0.197	0.276	0.598	0.016	Y	1000	BFNDF2DIE	YNG2214	
FNDF18141ST8	16-14	.187 x .032	0.197	0.276	0.598	0.016	Y	1000	BFNDF2DIE	YNG2214	
FNDF18141T	16-14	.250 x .032	0.260	0.299	0.598	0.016	Y	1000	BFNDF2DIE	YNG2214	



Bullet Connectors

Vinyl Insulated Bullet Connectors

Vinyl Fully Insulated Female Receptacle

Material: Tin Plated Brass with Butted Seam

Insulation Material: PVC Vinyl

Maximum Electrical Rating: 75°C, 300V

Maximum Electrical Current: 22-16: 10 Amps

16-14: 15 Amps

12-10: 24 Amps

Barrel ID (d1): 0.067

Barrel ID (d1): 0.091

Barrel ID (d1): 0.134

T = Material thickness

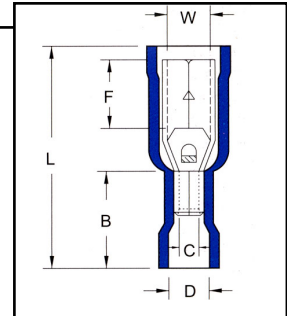

HOFFMAN PART NO.	WIRE SIZE	DIAMETER	DIMENSIONS (INCHES)							T	UL	TAPE MOUNT REEL QTY	DIE FOR TAPE MOUNT	HAND TOOL
			W	F	L	B	D	T	UL					
CVGF2216T5	22-16	0.156	0.154	0.276	0.906	0.413	0.157	0.016	Y	500	3F2216	YNM2210C		
CVGF1614T5	16-14	0.156	0.154	0.276	0.925	0.413	0.177	0.016	Y	500	3F1614	YNM2210C		
CVGF1210T7	12-10	0.195	0.193	0.276	0.945	0.492	0.217	0.018	Y	500	3F1210	YNM2210C		

Vinyl Fully Insulated Female Receptacle with Support Sleeve

Material: Tin Plated Brass with Tin Plated Copper Support Sleeve

Insulation Material: PVC Vinyl

Maximum Electrical Rating: 75°C, 300V

Maximum Electrical Current: 22-16: 10 Amps

16-14: 15 Amps

12-10: 24 Amps

Barrel ID (d1): 0.067

Barrel ID (d1): 0.091

Barrel ID (d1): 0.134

T = Material thickness

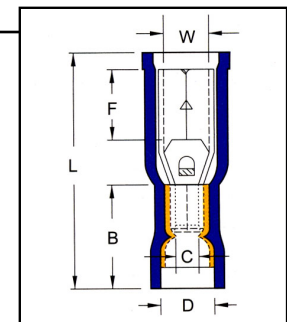

HOFFMAN PART NO.	WIRE SIZE	DIAMETER	DIMENSIONS (INCHES)							T	UL	TAPE MOUNT REEL QTY	DIE FOR TAPE MOUNT	HAND TOOL
			W	F	L	B	D	T	UL					
CVDGF2216T5	22-16	0.156	0.154	0.276	0.917	0.413	0.15	0.016	Y	500	3V2216	YNM2210		
CVDGF2216T5/J	22-16	0.156	0.156	0.335	0.945	0.394	0.106	0.016	Y	500	3V2216	YNT2216		
CVDGF1614T5	16-14	0.156	0.154	0.276	0.917	0.413	0.185	0.016	Y	500	3V1614	YNM2210		
CVDGF1614T7	16-14	0.195	0.193	0.276	0.917	0.413	0.185	0.016	Y	500	3V1614	YNM2210		
CVDGF1210T7	12-10	0.195	0.193	0.276	0.988	0.492	0.244	0.018	Y	500	3V1210	YNM2210		

Vinyl Insulated Male Bullet

Material: Tin Plated Brass with Butted Seam
Insulation Material: PVC Vinyl
Maximum Electrical Rating: 75°C, 300V
Maximum Electrical Current: 22-16: 10 Amps
 16-14: 15 Amps
 12-10: 24 Amps

Barrel ID (d1): 0.067
Barrel ID (d1): 0.091
Barrel ID (d1): 0.134

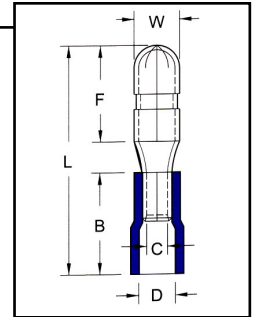

T = Material thickness

HOFFMAN PART NO.	WIRE SIZE	DIMENSIONS (INCHES)								T	UL	TAPE MOUNT REEL QTY	DIE FOR TAPE MOUNT	HAND TOOL
		DIAMETER	W	F	L	B	D							
FVGM2216T5	22-16	0.156	0.157	0.335	0.827	0.394	0.157	0.016	Y	1000	3F2216	YNM2210C		
FVGM1614T5	16-14	0.156	0.157	0.335	0.827	0.394	0.177	0.016	Y	1000	2F1614	YNM2210C		
FVGM1614T5/J	16-14	0.156	0.156	0.343	0.795	0.374	0.169	0.016	Y	1000	3F1614	YNT1614		
FVGM1210T7	12-10	0.195	0.197	0.335	0.925	0.512	0.217	0.016	Y	500	3F1210	YNM2210C		

Vinyl Insulated Male Bullet with Support Sleeve

Material: Tin Plated Brass with Tin Plated Copper Support Sleeve
Insulation Material: PVC Vinyl
Maximum Electrical Rating: 75°C, 300V
Maximum Electrical Current: 22-16: 10 Amps
 16-14: 15 Amps
 12-10: 24 Amps

Barrel ID (d1): 0.067
Barrel ID (d1): 0.091
Barrel ID (d1): 0.134

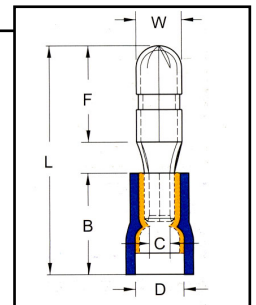

T = Material thickness

HOFFMAN PART NO.	WIRE SIZE	DIMENSIONS (INCHES)								T	UL	TAPE MOUNT REEL QTY	DIE FOR TAPE MOUNT	HAND TOOL
		DIAMETER	W	F	L	B	D							
FVDGM2216T5	22-16	0.156	0.157	0.335	0.846	0.413	0.15	0.016	Y	1000	3V2216	YNM2210		
FVDGM2216T5/J	22-16	0.156	0.156	0.343	0.795	0.374	0.138	0.016	Y	1000	3V2216	YNT2216		
FVDGM1614T5	16-14	0.156	0.157	0.335	0.854	0.413	0.185	0.016	Y	1000	3V1614	YNM2210		
FVDGM1614T7	16-14	0.195	0.197	0.335	0.835	0.413	0.185	0.016	Y	1000	3V1614	YNM2210		
FVDGM1614T7/J	16-14	0.195	0.156	0.343	0.795	0.374	0.169	0.016	Y	1000	3V1614	YNT1614		
FVDGM1210T7	12-10	0.195	0.197	0.335	0.945	0.512	0.244	0.016	Y	500	3V1210	YNM2210		



Nylon Insulated Bullets

Nylon Fully Insulated Female Receptacle with Support Sleeve

Material: Tin Plated Brass with Tin Plated Copper Support Sleeve

Insulation Material: 6/6 Nylon

Maximum Electrical Rating: 105°C, 600 V

Maximum Electrical Current: 22-16: 10 Amps

16-14: 15 Amps

12-10: 24 Amps

Barrel ID (d1): 0.134

Barrel ID (d1): 0.091

Barrel ID (d1): 0.134

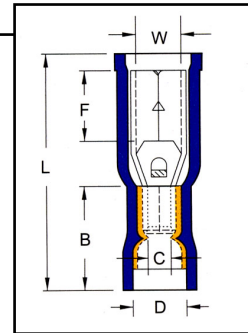

T = Material thickness

HOFFMAN PART NO.	WIRE SIZE	DIAMETER	DIMENSIONS (INCHES)							UL	TAPE MOUNT REEL QTY	DIE FOR TAPE MOUNT	HAND TOOL
			W	F	L	B	D	T					
CNDGF2216T5	22-16	156	0.154	0.276	0.992	0.433	0.157	0.016	Y	500	3V2216	YNM2210	
CNDGF1614T5	16-14	156	0.154	0.276	0.992	0.433	0.197	0.016	Y	500	3V1614	YNM2210	
CNDGF1614T7	16-14	195	0.193	0.276	0.992	0.433	0.197	0.016	Y	500	3V1614	YNM2210	
*FNDGF1210T7	12-10	195	0.193	0.276	0.965	0.512	0.256	0.018	Y	500	3V1210	YNM2210	

* This part is only partially insulated

Nylon Fully Insulated Male Bullet with Support Sleeve

Material: Tin Plated Brass with Tin Plated Copper Support Sleeve

Insulation Material: 6/6 Nylon

Maximum Electrical Rating: 105°C, 600 V

Maximum Electrical Current: 22-16: 10 Amps

16-14: 15 Amps

12-10: 24 Amps

Barrel ID (d1): 0.067

Barrel ID (d1): 0.091

Barrel ID (d1): 0.134

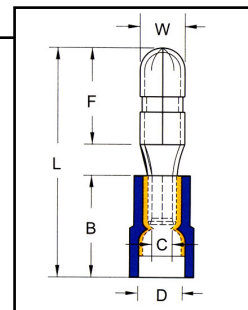

T = Material thickness

HOFFMAN PART NO.	WIRE SIZE	DIAMETER	DIMENSIONS (INCHES)							UL	TAPE MOUNT REEL QTY	DIE FOR TAPE MOUNT	HAND TOOL
			W	F	L	B	D	T					
FNDGM2216T5	22-16	156	0.157	0.335	0.866	0.433	0.157	0.016	Y	1000	3V2216	YNM2210	
FNDGM1614T5	16-14	156	0.157	0.335	0.866	0.433	0.197	0.016	Y	1000	3V1614	YNM2210	
FNDGM1614T7	16-14	195	0.197	0.335	0.866	0.433	0.197	0.016	Y	1000	3V1614	YNM2210	
FNDGM1210T7	12-10	195	0.197	0.335	0.925	0.512	0.256	0.016	Y	500	3V1210	YNM2210	

Open Barrel Disconnects

Female Open Barrel Disconnect

Material: Tin Plated Brass
Temperature: 300°F
Maximum Electrical Current: 22-16: 10 Amps
 16-14: 15 Amps
 12-10: 24 Amps

Female

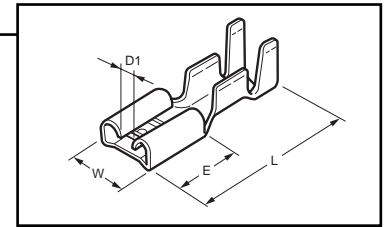

T = Material thickness

HOFFMAN PART NO.	WIRE SIZE	TAB	DIMENSIONS (INCHES)					MATING TAB THK.	UL	REEL QTY	HAND TOOL
			W	L	E	D1	T				
LTO01T110N	24-20	.110 x .020	0.146	0.606	0.248	0.024	0.010	0.020	Y	*SEE METAL STRIP	YHF200
LT041T110N	20-16	.110 x .020	0.146	0.606	0.248	0.024	0.010	0.020	Y	*SEE METAL STRIP	YHF200
LT041T187N/J	20-16	.187 x .020	0.220	0.591	0.248	0.059	0.013	0.020	Y	*SEE METAL STRIP	YHF200
LT021T250N	22-18	.250 x .032	0.303	0.748	0.307	0.094	0.016	0.031	Y	*SEE METAL STRIP	YHF200
LT061T250N	18-14	.250 x .032	0.303	0.748	0.307	0.063	0.018	0.031	Y	*SEE METAL STRIP	YHF200
LT081T250N/J	14-10	.250 x .032	0.299	0.772	0.315	0.063	0.018	0.031	Y	*SEE METAL STRIP	YHF200

Open Barrel Disconnect with Locking Tab

Material: Tin Plated Brass
Temperature: 300°F
Maximum Electrical Current: 22-16: 10 Amps
 16-14: 15 Amps
 12-10: 24 Amps

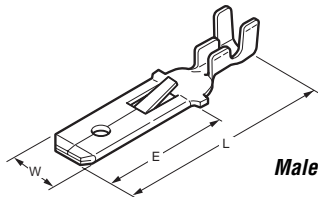

Male

Female

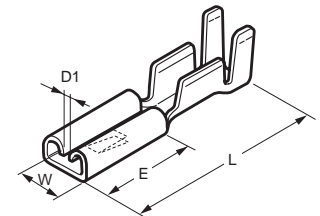

T = Material thickness

FEMALE PART NO.	WIRE SIZE	TAB	DIMENSIONS (INCHES)					MATING TAB THK.	UL	REEL QTY	HAND TOOL
			W	L	E	D1	T				
FEMALE											
LT101T110N/J	22-20	.110 x .020	0.146	0.602	0.248	0.028	0.010	0.020	N	*SEE METAL STRIP	YHF200
LT141T110N/J	20-16	.110 x .020	0.146	0.602	0.248	0.028	0.010	0.020	N	*SEE METAL STRIP	YHF200
LT151T250N/J	20-14	.250 x .032	0.295	0.756	0.303	0.035	0.013	0.032	Y	*SEE METAL STRIP	YHF200
LT161T250/J	18-14	.250 x .032	0.300	0.748	0.307	0.090	0.018	0.032	N	*SEE METAL STRIP	YHF200

MALE PART NO.	WIRE SIZE	TAB	DIMENSIONS (INCHES)					TAB THICKNESS	UL	REEL QTY	HAND TOOL
			W	L	E	D1	T				
MALE											
LIM01T110A	22-20	.110 x .020	0.110	0.811	0.472	NA	0.020	0.020	Y	*SEE METAL STRIP	YHF200
LIM41T110B/J	20-16	.110 x .020	0.110	0.811	0.472	NA	0.020	0.020	Y	*SEE METAL STRIP	YHF200
LIM51T250N/J	20-14	.250 x .032	0.236	0.965	0.512	NA	0.016	0.033	Y	*SEE METAL STRIP	YHF200
LIM61T250/J	18-14	.250 x .032	0.236	1.130	0.622	NA	0.016	0.033	N	*SEE METAL STRIP	YHF200

Housings for LTI and LIM - See Metal Strip Male and Female Disconnect Housings Section

***For Housing Click Here**
 (Housings, page 76)



Specialty Connectors

Double Male Insulated Terminal

Material: Tin Plated Brass
Insulation Material: 6/6 Nylon
Maximum Electrical Rating: 105°C, 300V

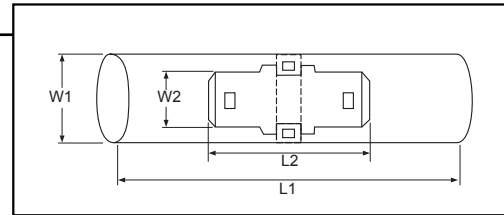

HOFFMAN PART NO.	TAB	DIMENSIONS (INCHES)				UL
		W1	W2	L1	L2	
VCDF181411RT	.250 x .032	0.472	0.248	1.969	0.882	N

Non-Insulated Male / Female Disconnects

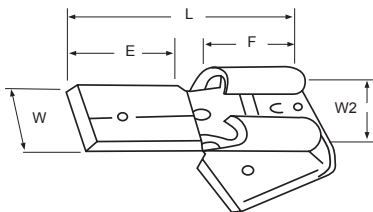

1DF2DM250

2DM1DF250

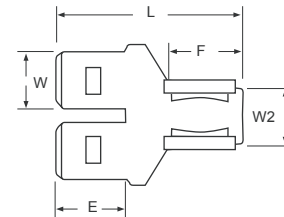

HOFFMAN PART NO.	TYPE	TAB	DIMENSIONS (INCHES)					UL
			W	W2	L	E	F	
2DM1DF250	Male Disconnect	.250 x .032	0.248	0.248	0.8295	0.346	0.320	N
1DF2DM250	Female Disconnect	.250 X .032	0.248	0.268	0.7320	0.325	0.317	N

Quick Tap Splice Connectors

Non-Insulated Female Quick Tap Splice Disconnects

Material Insulator: Vinyl
Material Insert: Tin Plated Brass
Maximum Electrical: 75°C, 300V
Maximum Current: 22 - 3 Amps, 20 - 4 Amps, 18 - 7 Amps, 16 - 10 Amps, 14 - 15 Amps, 12 - 20 Amps, 10 - 24 amps

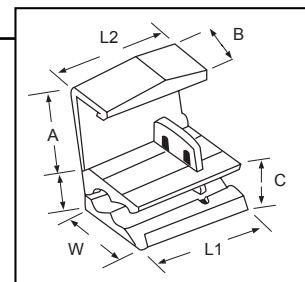

HOFFMAN PART NO.	TYPE	COLOR	FUN WIRE	TAP WIRE	DIMENSIONS (INCHES)						UL
					A	B	C	W	L1	L2	
TP18	Tap	Red	18-14	22-18	0.524	0.348	0.329	0.461	0.787	0.422	N
TP14	Tap	Blue	18-14	18.14	0.532	0.343	0.323	0.465	0.792	0.422	N
TP10	Tap	Yellow	10-12	12-10	0.709	0.484	0.413	0.590	0.831	0.831	N
TH14	Thru Tap	White	18.14	18.14	0.532	0.343	0.323	0.465	0.792	0.422	N

Insulating Sleeves for Disconnects

Straight PVC Insulating Sleeves

Material: Soft PVC
Temperature: 75°C
Color: Transparent

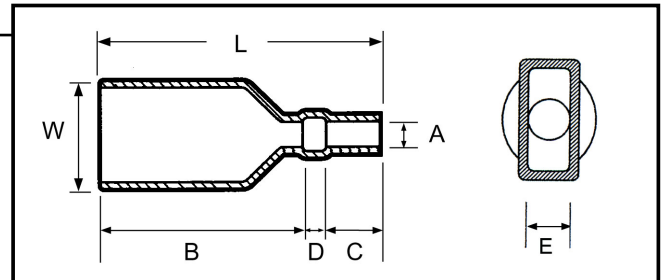

HOFFMAN PART NO.	TYPE	NEMA TAB WIDTH	DIMENSIONS (mm)							
			A	B	C	D	E	W	L	
KF1825	Straight	0.187	2.50	15.50	5.00	2.50	2.30	5.70	23.00	
KF1830	Straight	0.187	3.00	15.50	5.00	2.50	2.30	5.70	23.00	
KF2032	Straight	0.205	3.00	15.50	5.00	2.50	3.00	6.50	23.00	
KF2525	Straight	0.250	2.50	16.75	5.25	2.50	3.50	8.00	24.50	
KF2528	Straight	0.250	2.80	16.75	5.25	2.50	3.50	8.00	24.50	
KF2532	Straight	0.250	3.20	16.75	5.25	2.50	3.50	8.00	24.50	
KF2538	Straight	0.250	3.80	17.75	5.25	2.50	3.50	8.00	25.50	

Flag Type PVC Insulating Sleeves

Material: Soft PVC
Temperature: 75°C
Color: Transparent

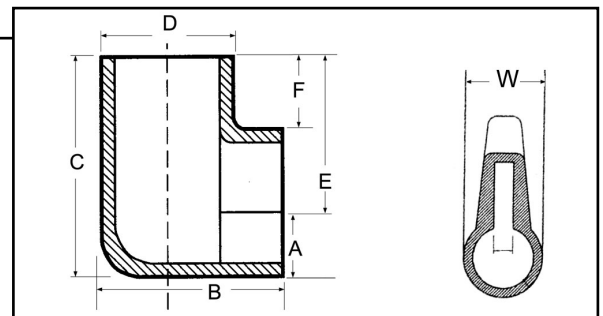

HOFFMAN PART NO.	TYPE	NEMA TAB WIDTH	DIMENSIONS (mm)							
			A	B	C	D	E	W	L	
KFF183012M	Flag Type/ Round Entry	0.187	3.00	12.00	13.00	5.70	6.00	2.30	8.00	
KFF1832	Flag Type	0.187	3.20	12.00	13.00	5.70	6.00	2.30	8.00	
KFF2540M	Flag Type/ Round Entry	0.250	4.00	16.00	17.00	8.00	9.00	3.50	8.00	
KFF2548	Flag Type	0.250	4.80	16.00	17.00	8.00	9.50	3.50	8.00	



X-ON Electronics

Largest Supplier of Electrical and Electronic Components

Click to view similar products for [Hoffman](#) manufacturer:

Other Similar products are found below :

[A-1412CHQR](#) [A-6P4G](#) [A-202408LP](#) [CSD20168SS](#) [CSD20206](#) [CSD20208SS](#) [CSD24168](#) [CSD36248](#) [CSD36308](#) [PCU7](#) [PDS76R](#)
[PRA197TP](#) [PT126](#) [A10086CH](#) [A1008CHNFSS](#) [A10106CH](#) [A10106CHFL](#) [A10106PHCW](#) [A1043DSC](#) [A1066JFGQRR](#) [A12106CHQRFG](#)
[A1212SC](#) [A1412CHNFSS](#) [A161208LP](#) [A161410CH](#) [A16148CHQRFG](#) [A16H12ALP](#) [A18P16AL](#) [A24H2408SSLP](#) [A24H24BLP](#)
[Q13138PCE](#) [A36P24](#) [Q3PBPCDM](#) [A404CH](#) [A606CHNF](#) [A606NF](#) [A806SC](#) [A845JFGR](#) [A864CHQRFGW](#) [A90P36F1](#) [HJ1412HWPL2LG](#)
[HJ1816HWPL2LG](#) [RHJ1210HWPL2LG](#) [AS125SS](#) [ASE10X10X4](#) [ASE12X12X4](#) [E1PBG](#) [E2PBG](#) [E3PB](#) [LED24V15](#)