

Type RN73 Series

Key Features

High precision -
TCR 5ppm/°C and
10ppm/°C

Tolerance down to 0.01%

Thin film (nichrome)

Terminal finish –
electroplated 100% matte
Sn



Applications

Communications

Industrial Controls

Instrumentation

Medical

The RN73 series is a high stability precision chip resistor range offering various power dissipations relating to chip size, TCR's down to 5ppm/°C and resistance tolerances to 0.01%. The resistor is produced with three sputtered layers giving optimum performance. Values are restricted to the E96 and E24 value grids. The RN73 has accurate and uniform physical dimensions to facilitate placement.

Electrical Characteristics

Rated Power @ 70°C		0402						0603					
		0.063W						0.063W					
Resistance Range Ω	Min	49R9	49R9	49R9	49R9	49R9	49R9	24R9	24R9	24R9	4R7	24R9	4R7
	Max	5K0	12K	5K0	12K	5K0	60K	15K	100K	15K	332K	15K	511K
Tolerance (%)		0.01		0.05		0.1		0.01		0.05		0.1	
Code Letter		L		A		B		L		A		B	
T.C.R. (PPM°C)		5	10	5	10	5	10	5	10	5	10	5	10
Code Letter		A	C	A	C	A	C	A	C	A	C	A	C
Selection Series		E24 & E96						E24 & E96					
Max operating Voltage		25V						50V					
Max. Overload voltage		50V						100V					
Operating Temp. range		-55 ~ +155°C						-55 ~ +155°C					
Insulation Resistance (dry min.)		1000MΩ						1000MΩ					
Stability		0.5%						0.5%					

		0805						1206					
Rated Power @ 70°C		0.1W						0.125W					
Resistance Range Ω	Min	24R9	24R9	24R9	4R7	24R9	4R7	24R9	24R9	24R9	4R7	24R9	4R7
	Max	30K	200K	30K	1M0	30K	1M0	49K9	499K	49K9	1M0	49K9	1M0
Tolerance (%)		0.01		0.05		0.1		0.01		0.05		0.1	
Code Letter		L		A		B		L		A		B	
T.C.R. (PPM°C)		5	10	5	10	5	10	5	10	5	10	5	10
Code Letter		A	C	A	C	A	C	A	C	A	C	A	C
Selection Series		E24 & E96						E24 & E96					
Max operating Voltage		100V						150V					
Max. Overload voltage		200V						300V					
Operating Temp. range		-55 ~ +155°C						-55 ~ +155°C					
Insulation Resistance (dry min.)		1000MΩ						1000MΩ					
Stability		0.5%						0.5%					

		1210						2010					
Rated Power @ 70°C		0.2W						0.25W					
Resistance Range Ω	Min	24R9	24R9	24R9	4R7	24R9	4R7	24R9	24R9	24R9	4R7	24R9	4R7
	Max	49K9	499K	49K9	1M0	49K9	1M0	100K	499K	100K	1M0	100K	1M0
Tolerance (%)		0.01		0.05		0.1		0.01		0.05		0.1	
Code Letter		L		A		B		L		A		B	
T.C.R. (PPM°C)		5	10	5	10	5	10	5	10	5	10	5	10
Code Letter		A	C	A	C	A	C	A	C	A	C	A	C
Selection Series		E24 & E96						E24 & E96					
Max operating Voltage		150V						150V					
Max. Overload voltage		300V						300V					
Operating Temp. range		-55 ~ +155°C						-55 ~ +155°C					
Insulation Resistance (dry min.)		1000MΩ						1000MΩ					
Stability		0.5%						0.5%					

		2512					
Rated Power @ 70°C		0.5W					
Resistance Range Ω	Min	24R9	24R9	24R9	4R7	24R9	4R7
	Max	100K	499K	100K	1M0	100K	1M0
Tolerance (%)		0.01		0.05		0.1	
Code Letter		L		A		B	
T.C.R. (PPM°C)		5	10	5	10	5	10
Code Letter		A	C	A	C	A	C
Selection Series		E24 & E96					
Max operating Voltage		150V					
Max. Overload voltage		300V					
Operating Temp. range		-55 ~ +155°C					
Insulation Resistance (dry min.)		1000MΩ					
Stability		0.5%					

Operating Voltage= $\sqrt{P \cdot R}$ or Max. operating voltage listed above, whichever is lower.

Overload Voltage= $2.5 \cdot \sqrt{P \cdot R}$ or Max. overload voltage listed above, whichever is lower.

Environmental Characteristics

Item	Requirement		Test Method
	Tol. $\leq 0.05\%$	TOL. $> 0.05\%$	
Temperature Coefficient of Resistance (TCR)	As per TCRs specified in Electrical Characteristics tables		MIL-STD-202 Method 304 +25/-55/+25/+125/+25°C
Short Time Overload	$\Delta R \pm 0.05\%$	$\Delta R \pm 0.2\%$	JIS-C-5201-1 5.5 RCWV*2.5 or Max. overload voltage whichever is lower for 5 seconds
Insulation Resistance	$> 1000 \text{ M}\Omega$		MIL-STD-202 Method 302 Apply 100VDC for 1 minute
Endurance	$\Delta R \pm 0.05\%$	$\Delta R \pm 0.2\%$	MIL-STD-202 Method 108A 70 \pm 2°C, RCWV for 1000 hrs with 1.5 hrs "ON" and 0.5 hrs "OFF"
	$> 7\text{k}\Omega \Delta R \pm 0.5\%$		
Damp Heat with Load	$\Delta R \pm 0.05\%$	$\Delta R \pm 0.3\%$	MIL-STD-202 Method 103B 40 \pm 2°C, 90~95% R.H. RCWV for 1000 hrs with 1.5 hrs "ON" and 0.5 hrs "OFF"
Bending Strength	$\Delta R \pm 0.05\%$	$\Delta R \pm 0.2\%$	JIS-C-5201-1 6.1.4 Bending amplitude 3 mm for 10 seconds
Solderability	95% min. coverage		MIL-STD-202 Method 208H 245 \pm 5°C for 3 seconds
Resistance to Soldering Heat	$\Delta R \pm 0.05\%$	$\Delta R \pm 0.2\%$	MIL-STD-202 Method 210E 260 \pm 5°C for 10 seconds
Dielectric Withstand Voltage	By Type		MIL-STD-202 Method 301 Max. overload voltage for 1 minute
Thermal Shock	$\Delta R \pm 0.05\%$	$\Delta R \pm 0.25\%$	MIL-STD-202 Method 107G -55°C ~150°C, 100 cycles
Low Temperature Operation	$\Delta R \pm 0.05\%$	$\Delta R \pm 0.2\%$	JIS-C-5201-1 7.1 1 hour, -65°C, followed by 45 minutes of RCWV

Storage Temperature: 25 \pm 3°C; Humidity < 80%RH

Derating Curve

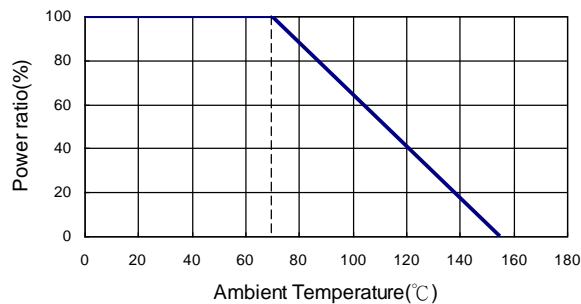

For resistors operated in ambient temperatures above 70°C, power rating must be derated in accordance with this curve

Construction and dimensions

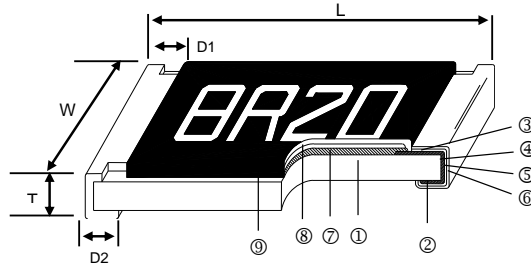

① Alumina Substrate	④ Edge Electrode (NiCr)	⑦ Resistor Layer (NiCr)
② Bottom Electrode (Ag)	⑤ Barrier Layer (Ni)	⑧ Overcoat (Epoxy)
③ Top Electrode (Ag)	⑥ External Electrode (Sn)	⑨ Marking

Size	L (mm)	W (mm)	T (mm)	D1 (mm)	D2 (mm)	Weight (g) (1000 Pcs.)
0402	1.00±0.05	0.50±0.05	0.30±0.05	0.20±0.10	0.20±0.10	0.54
0603	1.55±0.10	0.80±0.10	0.45±0.10	0.30±0.20	0.30±0.20	1.83
0805	2.00±0.15	1.25±0.15	0.55±0.10	0.30±0.20	0.40±0.20	4.71
1206	3.05±0.15	1.55±0.15	0.55±0.10	0.42±0.20	0.35±0.25	9.02
1210	3.10±0.15	2.40±0.15	0.55±0.10	0.40±0.20	0.55±0.25	10
2010	4.90±0.15	2.40±0.15	0.55±0.10	0.60±0.30	0.50±0.25	23.61
2512	6.30±0.15	3.10±0.15	0.55±0.10	0.60±0.30	0.50±0.25	38.06

Suggested PCB Layout Plan

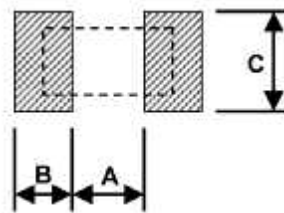

Recommended Land Pattern			
Size	A	B	C
0402	0.50	0.50	0.60±0.2
0603	0.80	1.00	0.90±0.2
0805	1.00	1.00	1.35±0.2
1206	2.00	1.15	1.70±0.2
1210	2.00	1.15	2.50±0.2
2010	3.60	1.40	2.50±0.2
2512	4.90	1.60	3.10±0.2

Marking

Case sizes 0805 to 2512 IEC 4 Digit Marking:

Resistance	100R (100Ω)	2K2 (2.2kΩ)	10K (10kΩ)	499K (499kΩ)	100K (100kΩ)
Code	1000	2201	1002	4992	1003

Case Size 0603 E24 3 digit marking – Example 101 = 100R 102=1K0

E24	10	11	12	13	15	16	18	20	22	24	27	30
	33	36	39	43	47	51	56	62	68	75	82	91

Case size 0603 E96 3 digit marking – Examples 14C = 13K7 68B = 4K99 68X = 49R9

Code	E96	Code	E96	Code	E96	Code	E96
01	100	25	178	49	316	73	562
02	102	26	182	50	324	74	576
03	105	27	187	51	332	75	590
04	107	28	191	52	340	76	604
05	110	29	196	53	348	77	619
06	113	30	200	54	357	78	634
07	115	31	205	55	365	79	649
08	118	32	210	56	374	80	665
09	121	33	215	57	383	81	681
10	124	34	221	58	392	82	698
11	127	35	226	59	402	83	715
12	130	36	232	60	412	84	732
13	133	37	237	61	422	85	750
14	137	38	243	62	432	86	768
15	140	39	249	63	442	87	787
16	143	40	255	64	453	88	806
17	147	41	261	65	464	89	825
18	150	42	267	66	475	90	845
19	154	43	274	67	487	91	866
20	158	44	280	68	499	92	887
21	162	45	287	69	511	93	909
22	165	46	294	70	523	94	931
23	169	47	301	71	536	95	953
24	174	48	309	72	549	96	976

Code	A	B	C	D	E	F	G	H	X	Y	Z
Multiplier	10 ⁰	10 ¹	10 ²	10 ³	10 ⁴	10 ⁵	10 ⁶	10 ⁷	10 ⁻¹	10 ⁻²	10 ⁻³

Packaging

Packing Quantity and Reel Specification

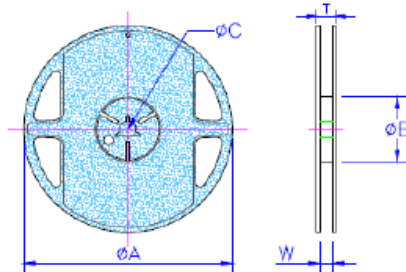

Size	ØA ±1.0	ØB ±1.0	ØC ±0.7	W ±1.0	T ±1.0	Paper Tape	Embossed Plastic Tape
0402	178.0	60.0	13.5	9.5	11.5	1000 / 5000	N/A
0603							
0805							
1206				13.5	15.5	N/A	4000
1210							
2010							
2512							

Paper tape Specification



Size	A ±0.05	B ±0.05	W ±0.10	E ±0.05	F ±0.05	P ₀	P ₁	P ₂ ±0.05	ØD ₀	T
0402	0.70	1.16	8.00	1.75	3.5	4.00 ±0.10	2.00 ±0.05	2.00	1.55 ±0.05	0.40 ±0.03
0603	1.10	1.90					4.00 ±0.10			0.60 ±0.03
0805	1.60	2.37					4.00 ±0.10			0.75 ±0.05
1206	2.00	3.55					4.00 ±0.05			1.60 ±0.10
1210	2.75	3.40					4.00 ±0.05			1.60 ±0.10

Peel force of top cover tape

The peel speed shall be about 300mm/min±5%

The peel force of top cover tape shall be between 8gf to 60gf

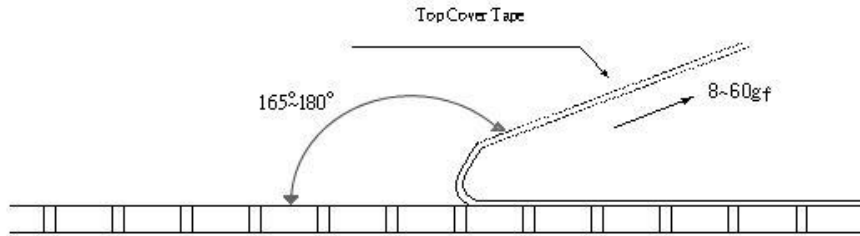

Embossed Plastic Tape Specifications

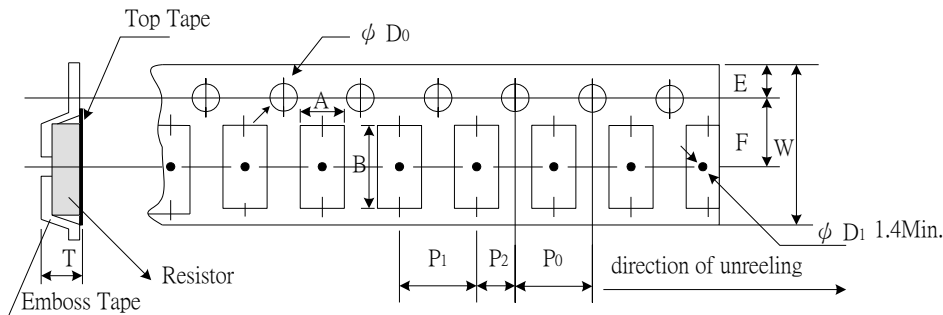

Type	A	B	W	E	F	P ₀	P ₁	P ₂	ØD ₀	T
2010	2.85±0.10	5.45±0.10	12.0±0.10	1.75±0.10	5.5±0.05	4.00±0.05	4.00±0.10	2.00±0.05	1.50±0.10	1.00±0.20
2512	3.40±0.10	6.65±0.10	12.0±0.10	1.75±0.10	5.5±0.05	4.00±0.05	4.00±0.10	2.00±0.05	1.50±0.10	1.00±0.20

Peel force of top cover tape

The peel speed shall be about 300mm/min±5%

The peel force of top cover tape shall be between 20gf to 80g

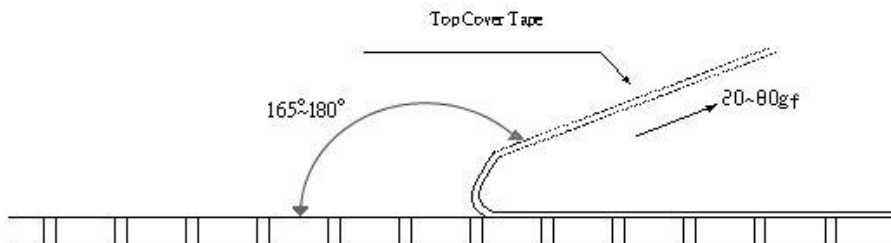

Reflow Solder Profile

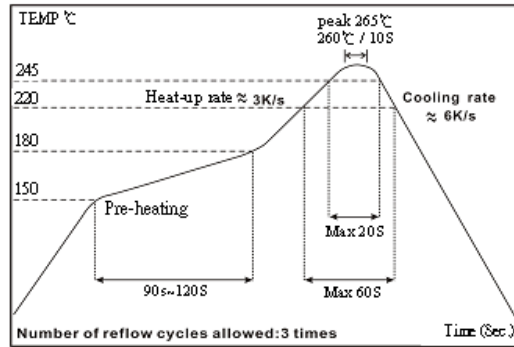

Time of Reflow soldering at maximum temperature point 260°C = 10s

Wave Solder Profile

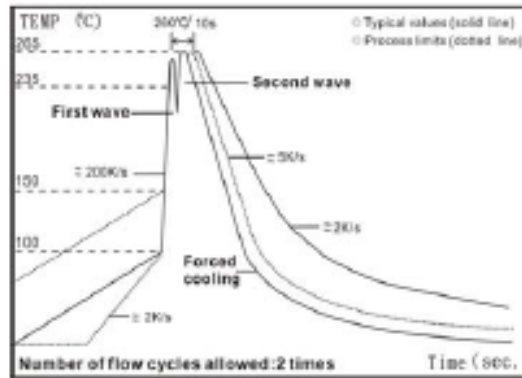

Time of Wave soldering at maximum temperature point 260°C = 10s

Time of Soldering Iron at maximum temperature point 410°C = 5s

How To Order

RN73	C	2A	100R	B	TD
Common Part	TCR	Package Size	Value	Tolerance	Packaging
RN73 - High Precision Resistors	A - ±5ppm/°C *C - ±10ppm/°C *preferred stock item	1E - 0402 1J - 0603 2A - 0805 2B - 1206 2E - 1210 2H - 2010 3A - 2512	100R (100Ω) 1K0 (1000Ω) 100K (100,000 Ω)	L - ±0.01% A - ±0.05% B - ±0.1%	TG - 250 cut tape length (1E, 1J, 2A, 2B) TDF - 1000 reel (1E, 1J, 2A, 2B) TD - 5000 reel (1E, 1J, 2A, 2B, 2E) TE - 4000 reel (2H, 3A only)

X-ON Electronics

Largest Supplier of Electrical and Electronic Components

Click to view similar products for [Thin Film Resistors - SMD category](#):

Click to view products by [TE Connectivity manufacturer](#):

Other Similar products are found below :

[7-2176089-6](#) [MCW0406MD1001DP500](#) [FCR1206J22R](#) [FCR1206J33R](#) [1-2176090-3](#) [1-2176089-6](#) [ERA-3EEB2742V](#)
[NCSR250F4M50DTRGF](#) [2176089-1](#) [2176090-4](#) [2176091-3](#) [CPA2512Q6R80FS-T10](#) [4-1625868-7](#) [5-1625868-9](#) [5-18022-5](#) [ERA-](#)
[3EEB2671V](#) [CFR0W4J0220A2P](#) [P1206Y1804FNNTA](#) [CPA2512E68R0FS-T10](#) [CPA2512Q4R70FS-T10](#) [8-2176091-9](#) [2-2176091-0](#)
[NCSR150FR003DTRT3F](#) [NTR06B5832CTRF](#) [NCSR200JR002DTRF](#) [RSJ372NL](#) [NRC-S12F4751TRF](#) [8-1625868-1](#) [1-2176092-4](#) [4-](#)
[2176093-9](#) [2176091-9](#) [RT1220P-101-M](#) [PLTU0805U1003LST5](#) [PLTU0603U2001LST5](#) [PLTU0805U1001LST5](#) [PLTU0603U4702LST5](#) [4-](#)
[2176089-0](#) [8-2176091-0](#) [6-2176091-8](#) [3-2176090-3](#) [1-2176092-7](#) [7-2176092-6](#) [7-2176088-7](#) [PCNM2512E1502BST5](#) [2-2176094-5](#)
[PCNM2512E3012BST5](#) [4-2176092-6](#) [3-2176091-4](#) [8-2176091-5](#) [7-2176089-5](#)