

# APHM-127-05-15

## Micro Peltier cooler module

### Data sheet

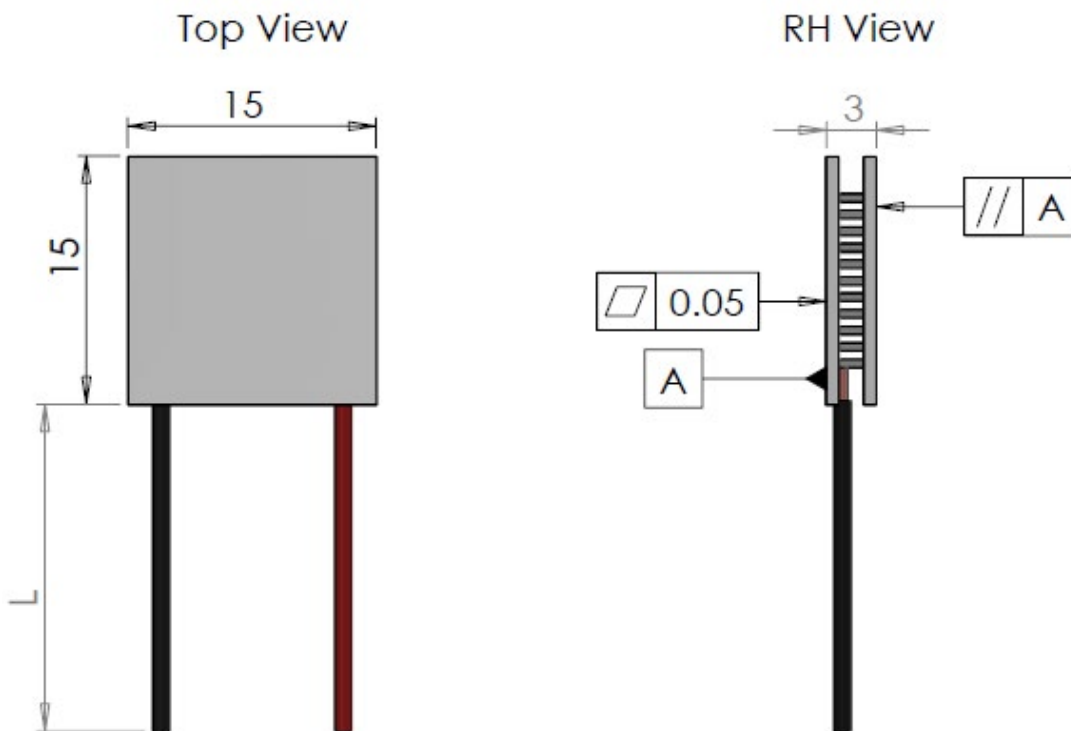

$I_{max}$	[A]	0.8
$V_{max}$	[Vdc]	15.5
$P_c \text{ max}$	[W]	7.4
$\Delta T_{max}$	[°C]	74
A	[mm]	15
A1	[mm]	15
B	[mm]	15
B1	[mm]	15
H	[mm]	3.0
L	[mm]	100

- (At hot side temperature  $T_h = 25^\circ\text{C} / 298\text{K}$ , under dry  $\text{N}_2$ )
- $P_c \text{ max}$  = Cooling power at  $\Delta T = 0$  and  $I = I_{max}$
- $\Delta T_{max}$  = Temperature difference at  $I = I_{max}$  and  $P_c = 0$
- Max hot side temperature  $T_h \leq 150^\circ\text{C}$  for best long term performance
- Max mounting pressure: 1.5MPa
- Wires: UL-style 1569,  $105^\circ\text{C}$  (Unstripped)
- Silicone sealed



# APHM-127-05-15

## Micro Peltier cooler module

Data sheet - At hot side temperature 27°C

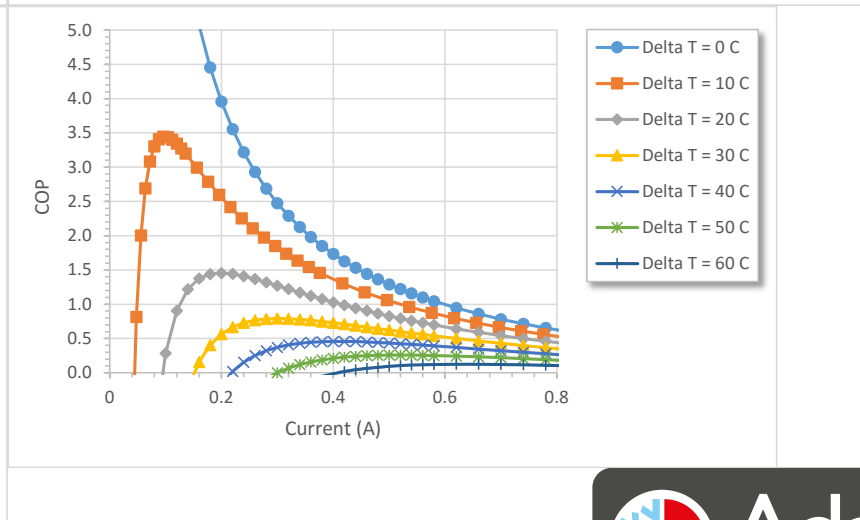
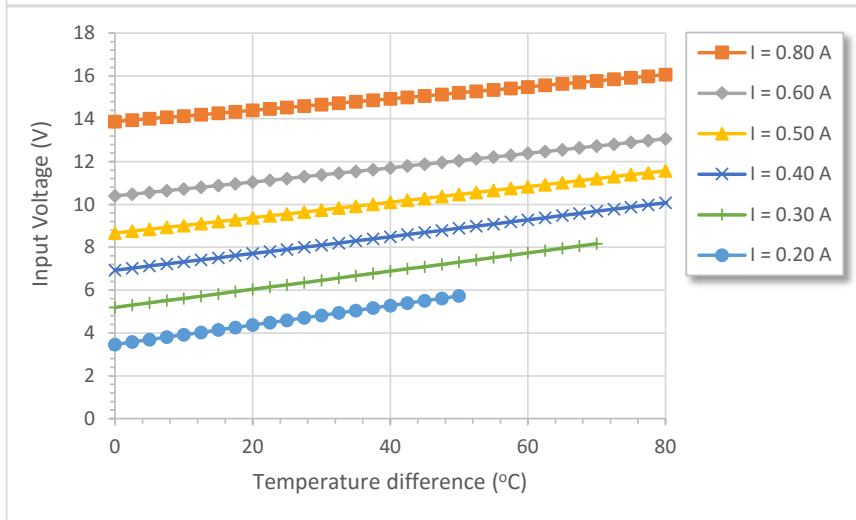
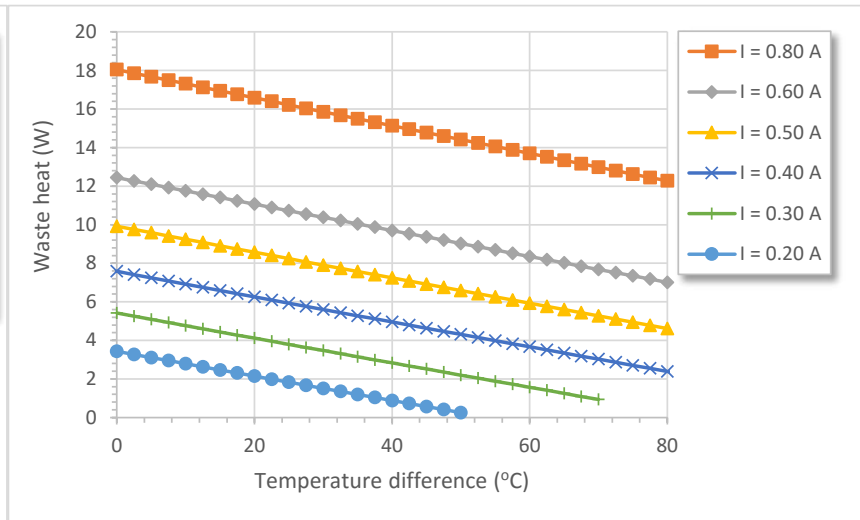
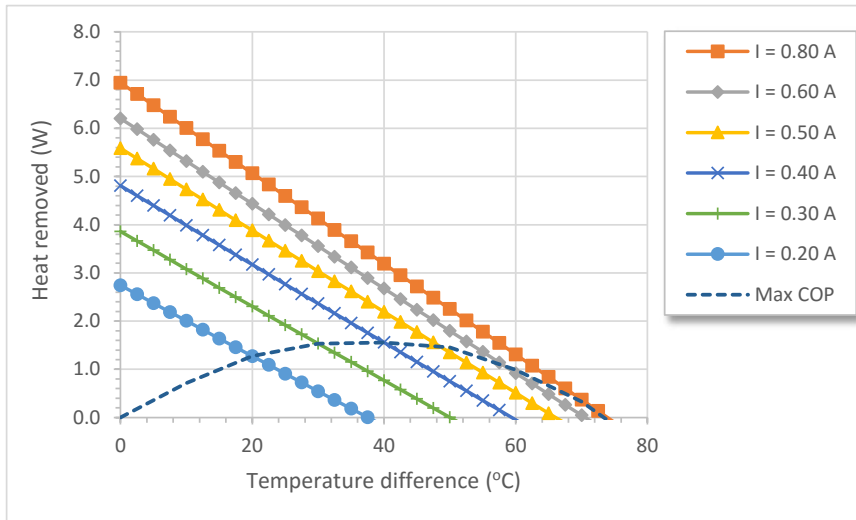

\*Note - Waste heat = Heat out of hot side



# APHM-127-05-15

## Micro Peltier cooler module

Data sheet - At hot side temperature 75°C

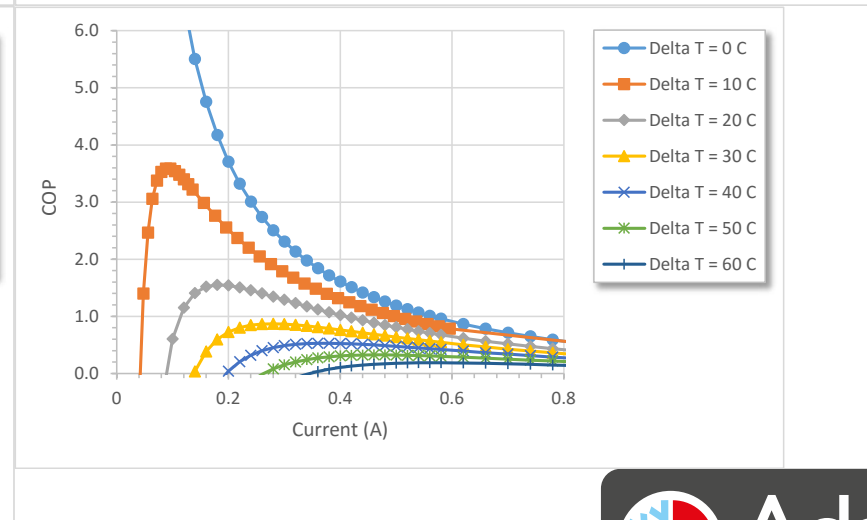
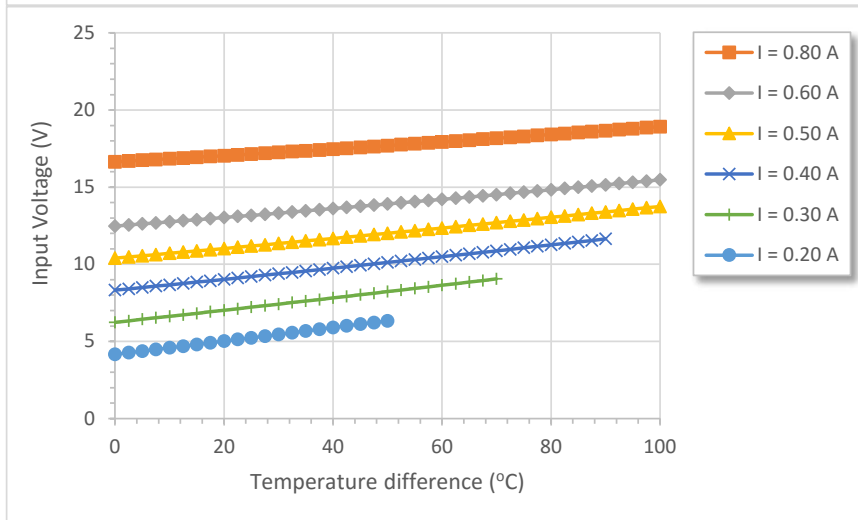
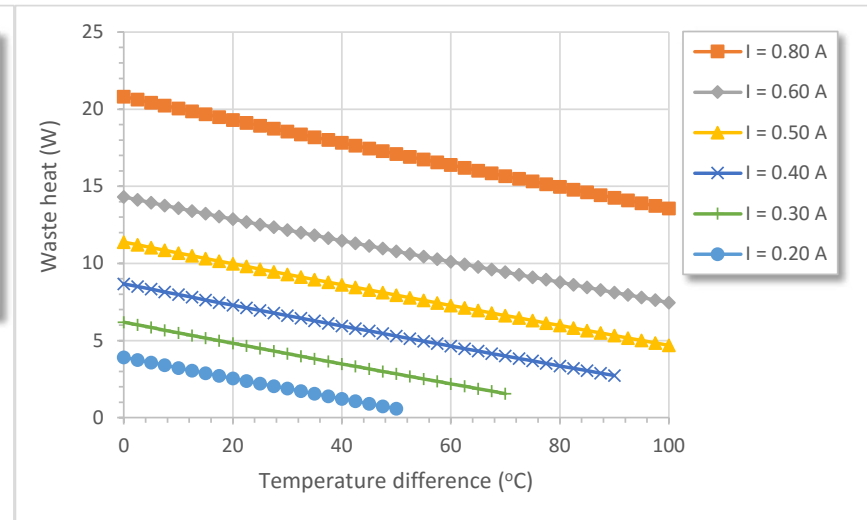
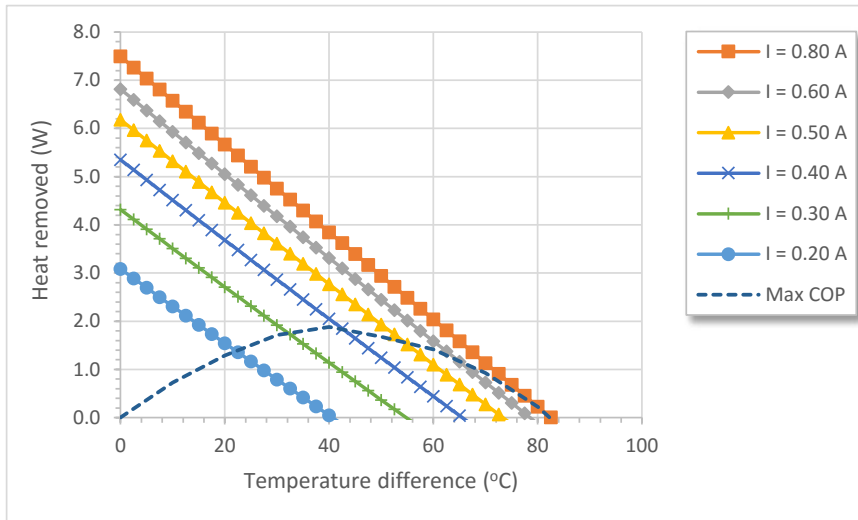

\*Note - Waste heat = Heat out of hot side

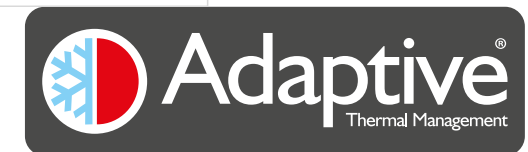

## **X-ON Electronics**

Largest Supplier of Electrical and Electronic Components

*Click to view similar products for [european thermodynamics manufacturer](#):*

Other Similar products are found below :

[AP3-070-20-25](#) [APHC-12706-S](#) [SF-06-150-S](#) [APH-031-10-13-S](#)