

# System 1, 3 & VT2 High Vacuum (Tip) Extraction Units

**T**HE smallest in our range of Bofa High Vacuum Extraction Systems. Designed specifically for portability and extremely low noise levels.

## Service and Maintenance

- Complete after sales service
- Low cost annual maintenance contracts – Ask for details
- Filter replacement and collection service
- FREE consultation service

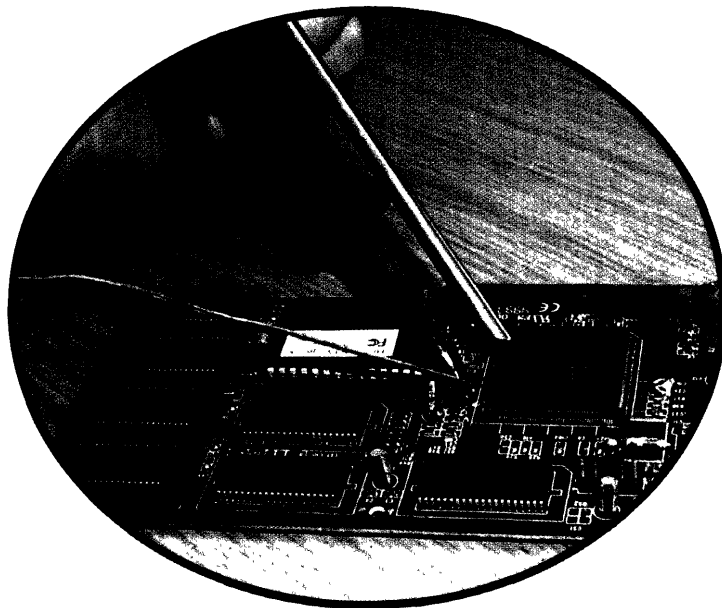

*Electrically Driven  
System 3*

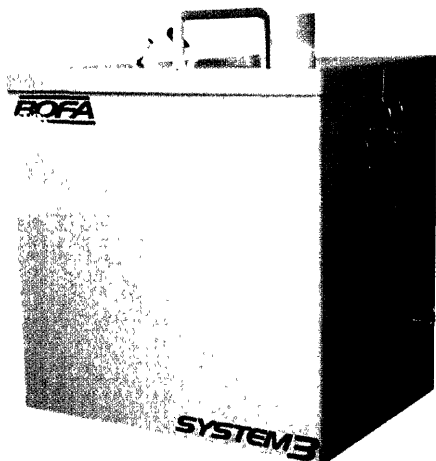

*Air Driven  
VT2*

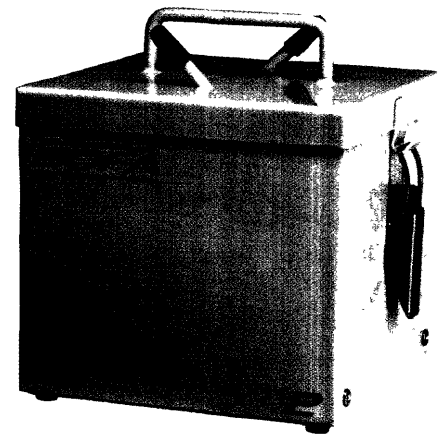

*Electrically Driven  
System 1*



System 1, 3 & VT2

## System 1 Specification









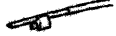

	Dimensions	Weight	Flow Rate (4.5mm I/D Hose)	Power Unit	Rated Output	Voltage	Noise Level	Filter Efficiency
EC	220(H)x171(D)x171(W)	3.0Kg	22-24 L/M	Linear	0.060kW	230 IpH	<48dBA	99.997
US	9"x7"x7"	6.6lbs		Pump	0.080kW	115 IpH		0.3 micron DOP

## System 3 Specification

	Dimensions	Weight	Flow Rate (4.5mm I/D Hose)	Power Unit	Rated Output	Voltage	Noise Level	Duct Size (for 3 irons)	Duct Run	Filter Efficiency	Number of Solder Stations
EC	285(H)x270(D)x195(W)	10Kg	22-30 L/M	Carbon Vane	0.12kW	230 IpH	<40dBA	32mm	10mtrs	99.997	2/3
US	11.5"x11"x8"	22lbs		Pump	0.145kW	115 IpH			33'	0.3 micron DOP	3

## System VT2 Venturi Specification

Dimensions	Weight	Flow Rate (4.5mm I/D Hose)	Power Unit	Air Requirements		Noise Level	Capacity
				Pressure	Flow		
170(H)x150(D)x170(W)	1Kg	22-30 L/M	Air Ejector	6 Bar	0.6 NI/S	<39dBA	2 Solder Irons

Installation kit	INSKT 3	Installation Kit for System 3	
Metcal Iron Conversion Kit for 002 iron	STSS-FXIA	Iron connector, silicon tube, fasteners and cleaning brush	
Metcal Iron Conversion Kit for SP200 iron	SP-FXIA	Iron connector, silicon tube, fasteners and cleaning brush	
Metcal universal iron holder	WSF	Holder for 002 and SP200 irons	
Weller Mini Iron Conversion Kit	WAK	Iron clip on kit, S/S tube, silicon tube, cleaning brush, fasteners and holder	
Weller integral iron	WIK	Handle, stainless steel tube, silicon tube, fasteners, holder and cleaning brush	
Adcola, Weller, Pace + (fits most other irons)	UAK	Iron clip on kit, S/S tube, silicon tube, cleaning brush, fasteners and holder	
ERSA Tip Tool	ERSA1	Iron connector, S/S tube, ESD silicon tube, fasteners, cleaning brush	
ERSA Micron Tool	ERSA2	Iron connector, S/S tube, ESD silicon tube, fasteners, cleaning brush	
ERSA Ergo Tool	ERSA3	Iron connector, S/S tube, ESD silicon tube, fasteners, cleaning brush	
Tech Tool			
Power Tool			
Hakko	HAKO1	Iron connector, S/S tube, silicon tube, fasteners, cleaning brush	
JBC Advanced 2010/2045	JBC1	Iron connectors, ESD silicon tube, fasteners	

## Filtration

**PRE-FILTER** – The pre-filter is designed solely to protect the life of the micro filter. Bofa use a pleated synthetic media with a separation of 95% of particulate down to 0.8 microns. In cases where exceptionally high amounts of particulate are generated higher efficiency filters can be installed with no adverse effect on flow rates.

**MICRO FILTER** – Bofa Micro filters incorporate a series of bonded webbing between the pleats. This feature not only ensures even spacing between each pleat but also alleviates the possibility of airflow vibration or collapse through pressure build up during gradual filter saturation. Each Micro filter is designed to withstand up to 6 times the maximum operating pressure for its designated unit, with a filter efficiency of 99.997% down to 0.3 microns and 95% as small as 0.01 microns.

**GAS FILTER** – The Gas filter is the last in line before the pump. It is therefore essential that there is no risk of dust deposits from the

gas media migrating to atmosphere. The Bofa media is an activated carbon specially impregnated with potassium permanganate. The Bofa media is bonded and moulded into a block or biscuit which totally eliminates dust migration.

Filters are produced in accordance to ISO 9002 with micron filtration complying to BS 3928. A certificate of conformity for each filter is available upon request.

A comprehensive range of specialised filters are available to cater for more demanding or diverse applications.

## Pump Technology

The pump is the heart of the unit and as such, any compromise on quality will have an adverse effect on performance and long term reliability. Bofa use only the highest quality pumps and motors in all their units. All pumps are individually matched to the motors and dynamically balanced accordingly. Each assembly is produced in accordance with ISO 9002 and CE marked.



Unit 3, Minster Park, Collingwood Road, West Moors, Wimborne, Dorset, England BH21 6QF  
Telephone: (Int +44) (0) 1202 896199 Fax: (Int +44) (0) 1202 894082 e-mail: sales@bofa.co.uk



## **INSKT 3**

# **INSTALLATION KIT FOR BOFA SYSTEM 3** **EXTRACTION UNIT**

### **CONTENTS**

<b>ITEM</b>	<b>QTY</b>	<b>DESCRIPTION</b>
1.	4x	2.5m Long 32mm Dia Tube
2.	1x	1.5m Long 32mm Dia Flexi Tube
3.	8x	Cobra Clip
4.	8x	Screw
5.	4x	Clear Plug
6.	1x	Red End Cap

### **INSTRUCTIONS**

Fix 32mm Tube to the most convenient position on the benches, usually at the back or underneath, using 2 cobra clips (item 3) and screws (item 4) per length of tube. The tube can be cut to length using a sharp knife or hacksaw. The tube can be joined together using 100mm lengths of flexible tube cut from the 1.5m length supplied. The flex pushes over the tube to make a vacuum tight connection. The remainder of the flexible tube should be used to connect the unit to the pipe work, the other end of the pipe run should be sealed by inserting the red end cap (item 6) into the tube.

At each point along the bench where a soldering iron is to be used, a 14mm hole should be drilled in the pipe and a clear plug inserted. (Care should be taken not to enlarge the hole size as the plug needs to be a tight fit.)

Typical layout shown overleaf.

Should you experience any difficulties with the installation please call our technical help line on: 01202 896199

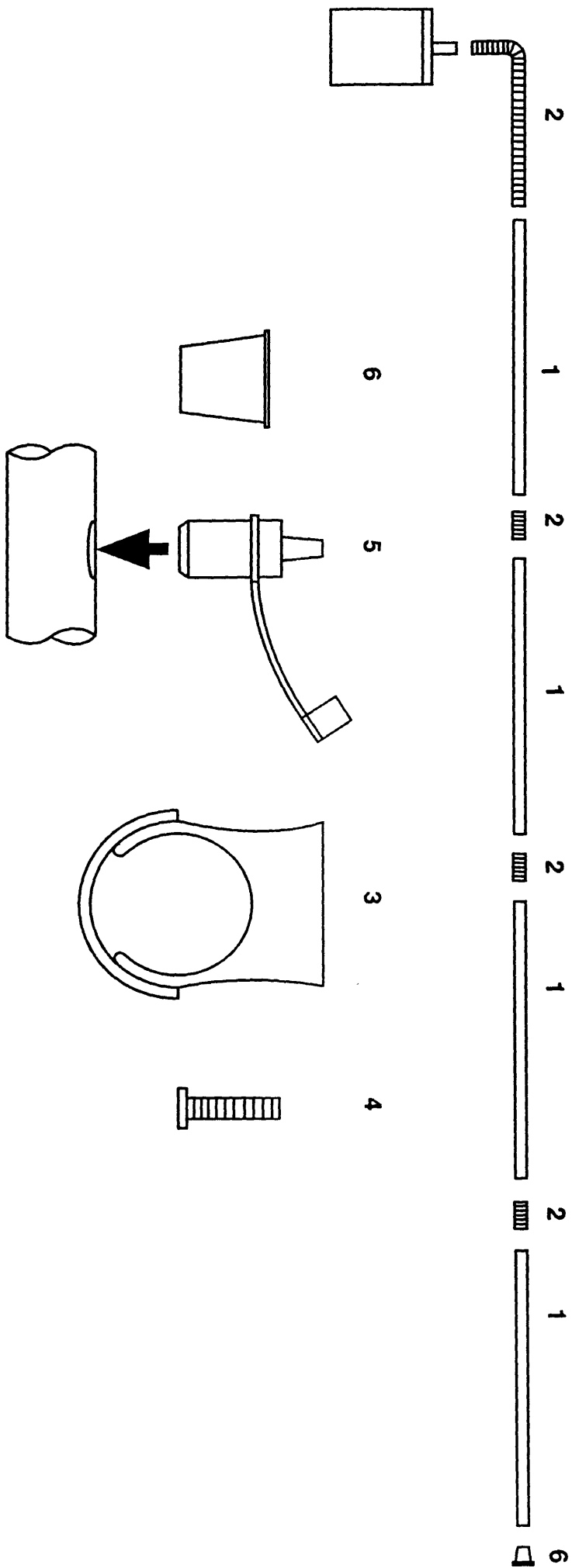

## **X-ON Electronics**

Largest Supplier of Electrical and Electronic Components

*Click to view similar products for [bofa](#) manufacturer:*

Other Similar products are found below :

[15-CF](#) [15-PF](#) [250-PF](#) [EFILT02](#)