



Chip beads

For general signal line

MMZ series

MMZ0603 type

MMZ0603

0603[0201 inch]*

* Dimensions Code JIS[EIA]

REMINDERS FOR USING THESE PRODUCTS

Before using these products, be sure to request the delivery specifications.

SAFETY REMINDERS

Please pay sufficient attention to the warnings for safe designing when using these products.

REMINDERS

- The storage period is less than 12 months. Be sure to follow the storage conditions (Temperature: 5 to 40°C, Humidity: 10 to 75% RH or less).
If the storage period elapses, the soldering of the terminal electrodes may deteriorate.
- Do not use or store in locations where there are conditions such as gas corrosion (salt, acid, alkali, etc.).
- Before soldering, be sure to preheat components.
The preheating temperature should be set so that the temperature difference between the solder temperature and chip temperature does not exceed 150°C.
- Soldering corrections after mounting should be within the range of the conditions determined in the specifications.
If overheated, a short circuit, performance deterioration, or lifespan shortening may occur.
- When embedding a printed circuit board where a chip is mounted to a set, be sure that residual stress is not given to the chip due to the overall distortion of the printed circuit board and partial distortion such as at screw tightening portions.
- Self heating (temperature increase) occurs when the power is turned ON, so the tolerance should be sufficient for the set thermal design.
- Carefully lay out the coil for the circuit board design of the non-magnetic shield type.
A malfunction may occur due to magnetic interference.
- Use a wrist band to discharge static electricity in your body through the grounding wire.
- Do not expose the products to magnets or magnetic fields.
- Do not use for a purpose outside of the contents regulated in the delivery specifications.
- The products listed on this catalog are intended for use in general electronic equipment (AV equipment, telecommunications equipment, home appliances, amusement equipment, computer equipment, personal equipment, office equipment, measurement equipment, industrial robots) under a normal operation and use condition.
The products are not designed or warranted to meet the requirements of the applications listed below, whose performance and/or quality require a more stringent level of safety or reliability, or whose failure, malfunction or trouble could cause serious damage to society, person or property.
If you intend to use the products in the applications listed below or if you have special requirements exceeding the range or conditions set forth in the each catalog, please contact us.

- (1) Aerospace/Aviation equipment
- (2) Transportation equipment (cars, electric trains, ships, etc.)
- (3) Medical equipment
- (4) Power-generation control equipment
- (5) Atomic energy-related equipment
- (6) Seabed equipment
- (7) Transportation control equipment

- (8) Public information-processing equipment
- (9) Military equipment
- (10) Electric heating apparatus, burning equipment
- (11) Disaster prevention/crime prevention equipment
- (12) Safety equipment
- (13) Other applications that are not considered general-purpose applications

When designing your equipment even for general-purpose applications, you are kindly requested to take into consideration securing protection circuit/device or providing backup circuits in your equipment.

Chip beads

For general signal line

Product compatible with RoHS directive
Halogen-free
Compatible with lead-free solders

Overview of MMZ0603 type

FEATURES

- Noise reduction solution for general signal line.
- Various frequency characteristics with 4 materials of different features for countermeasures against everything from general signals to high-speed signals.

APPLICATION

- Noise removal for mobile devices such as smartphones and tablet terminals, and various modules.
- Noise removal for PCs and recorders, household appliances such as STBs, smart grids, and industrial equipment.

PART NUMBER CONSTRUCTION

| MMZ | 0603 | S | 100 | C | T | 000 | | | |
|-------------|-----------------------|-------------|---------------|-----|----------------------------------|---------------------|-----------------|---------------|-----|
| Series name | LxWxT dimensions (mm) | | Material name | | Impedance (Ω) at 100MHz | Characteristic type | Packaging style | Internal code | |
| | 0603 | 0.6x0.3x0.3 | D | 100 | 10 | C | T | Taping | 000 |
| | | | F | 121 | 120 | | | | |
| | | | S | | | | | | |
| | | | Y | | | | | | |

OPERATING TEMPERATURE RANGE, PACKAGE QUANTITY, PRODUCT WEIGHT

| Type | Temperature range | | Package quantity (pieces/reel) | Individual weight (mg) |
|---------|-------------------------------|------------------------------|-----------------------------------|---------------------------|
| | Operating temperature (°C) | Storage temperature* (°C) | | |
| MMZ0603 | -55 to +125 | -55 to +125 | 15,000 | 0.3 |

* The Storage temperature range is for after the circuit board is mounted.

- RoHS Directive Compliant Product: See the following for more details. <https://product.tdk.com/info/en/environment/rohs/index.html>
- Halogen-free: Indicates that Cl content is less than 900ppm, Br content is less than 900ppm, and that the total Cl and Br content is less than 1500ppm.

 Please be sure to request delivery specifications that provide further details on the features and specifications of the products for proper and safe use.
Please note that the contents may change without any prior notice due to reasons such as upgrading.

MMZ0603 type

RECOMMENDED REFLOW PROFILE



| Preheating | | | Soldering | | Peak | |
|------------|-------|------------|-----------|-----------|--------------|------|
| Temp. | | Time | Temp. | Time | Temp. | Time |
| T1 | T2 | t1 | T3 | t2 | T4 | t3 |
| 150°C | 180°C | 60 to 120s | 230°C | 30 to 60s | 250 to 260°C | 10s |

MMZ0603 type

MATERIAL CHARACTERISTICS

S material: Standard type that features impedance characteristics similar to those of a typical ferrite core. For signal line applications in which the blocking region is near 100MHz. Impedance values selected for effectiveness at 40 to 300MHz.

Y material: High frequency range type intended for the 100MHz region and above.

For signal line applications in which the signal frequency is far from the cutoff frequency. Impedance values selected for effectiveness at 80 to 400MHz.

D material: For applications calling for low insertion loss at low frequencies and sharply increasing impedance at high frequencies.

Designed for high impedance at high frequencies (300MHz to 1GHz) for signal line applications.

F material: This new product inherits the characteristic of our D-material, namely its sharp impedance rise time, and its impedance peak frequency has been shifted higher into range. The product offers excellent noise suppression from 600MHz to as high as in the GHz range.

TYPICAL MATERIAL IMPEDANCE CHARACTERISTICS

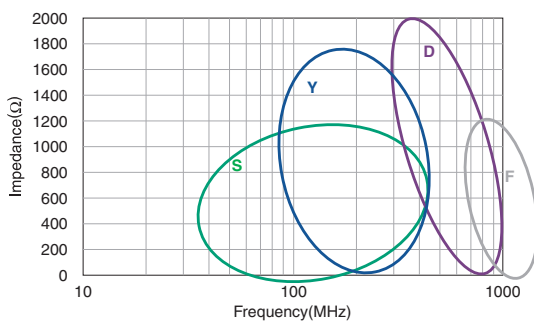

MMZ0603 type

■ SHAPE & DIMENSIONS

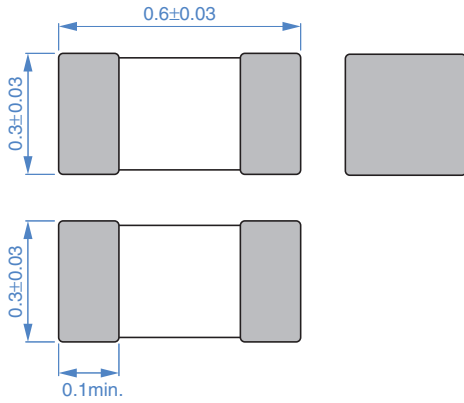

Dimensions in mm

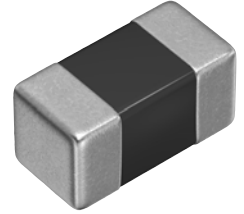

■ RECOMMENDED LAND PATTERN

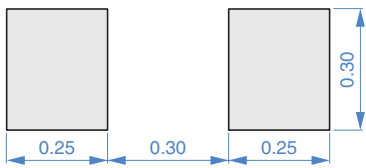

Dimensions in mm

MMZ0603 type

ELECTRICAL CHARACTERISTICS

CHARACTERISTICS SPECIFICATION TABLE

| Impedance [100MHz] (Ω) | | DC resistance (Ω)max. | Rated current (mA)max. | Part No. |
|---------------------------------------|---------------|-----------------------------------|---------------------------|------------------|
| | Tolerance | | | |
| 10 | $\pm 5\Omega$ | 0.05 | 1000 | MMZ0603S100CT000 |
| 80 | $\pm 25\%$ | 0.30 | 200 | MMZ0603S800CT000 |
| 120 | $\pm 25\%$ | 0.45 | 200 | MMZ0603S121CT000 |
| 240 | $\pm 25\%$ | 0.57 | 200 | MMZ0603S241CT000 |
| 470 | $\pm 25\%$ | 1.30 | 100 | MMZ0603S471CT000 |
| 600 | $\pm 25\%$ | 1.45 | 100 | MMZ0603S601CT000 |
| 75 | $\pm 25\%$ | 0.35 | 300 | MMZ0603Y750CT000 |
| 120 | $\pm 25\%$ | 0.39 | 200 | MMZ0603Y121CT000 |
| 240 | $\pm 25\%$ | 0.80 | 200 | MMZ0603Y241CT000 |
| 470 | $\pm 25\%$ | 1.40 | 200 | MMZ0603Y471CT000 |
| 600 | $\pm 25\%$ | 1.50 | 200 | MMZ0603Y601CT000 |
| 33 | $\pm 25\%$ | 0.70 | 200 | MMZ0603D330CT000 |
| 47 | $\pm 25\%$ | 0.70 | 200 | MMZ0603D470CT000 |
| 56 | $\pm 25\%$ | 0.95 | 100 | MMZ0603D560CT000 |
| 80 | $\pm 25\%$ | 1.25 | 100 | MMZ0603D800CT000 |
| 120 | $\pm 25\%$ | 1.40 | 100 | MMZ0603D121CT000 |
| 10 | $\pm 5\Omega$ | 0.50 | 200 | MMZ0603F100CT000 |
| 22 | $\pm 25\%$ | 1.00 | 200 | MMZ0603F220CT000 |
| 33 | $\pm 25\%$ | 1.30 | 150 | MMZ0603F330CT000 |

Measurement equipment

| Measurement item | Product No. | Manufacturer |
|------------------|--------------|-----------------------|
| Impedance | E4991A+16197 | Keysight Technologies |
| DC resistance | Type-7556 | Yokogawa |

* Equivalent measurement equipment may be used.

MMZ0603 type

ELECTRICAL CHARACTERISTICS

Z VS. FREQUENCY CHARACTERISTICS (BY SERIES)

MMZ0603S-C series

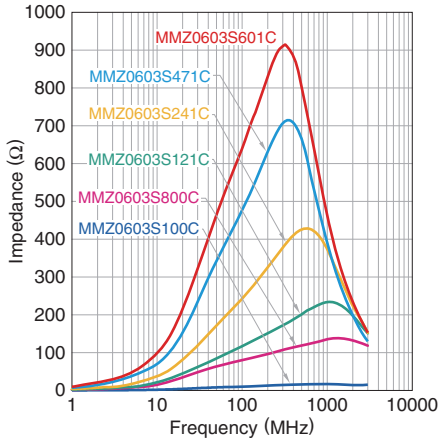

MMZ0603Y series

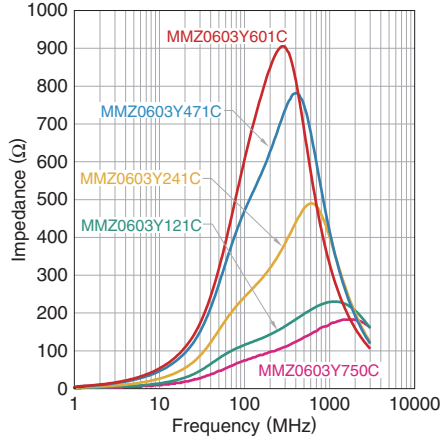

MMZ0603D series

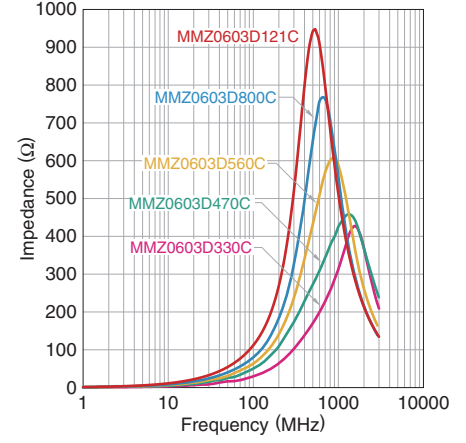

MMZ0603F series

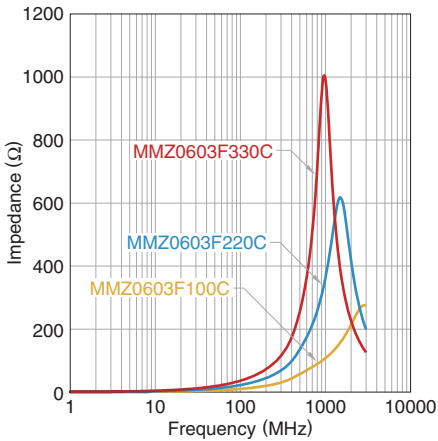

 Please be sure to request delivery specifications that provide further details on the features and specifications of the products for proper and safe use. Please note that the contents may change without any prior notice due to reasons such as upgrading.

MMZ0603 type

ELECTRICAL CHARACTERISTICS

Z, X, R VS. FREQUENCY CHARACTERISTICS

MMZ0603S100CT000

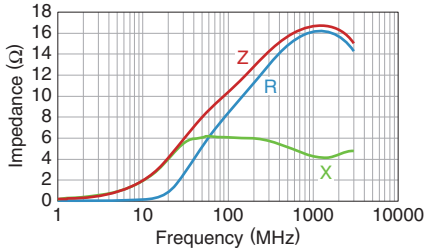

MMZ0603S800CT000

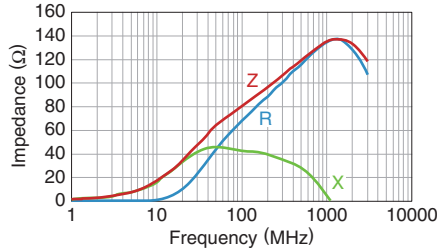

MMZ0603S121CT000

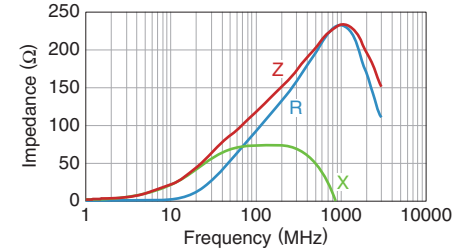

MMZ0603S241CT000

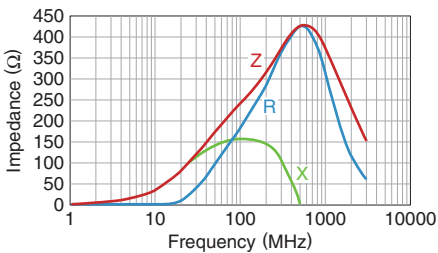

MMZ0603S471CT000

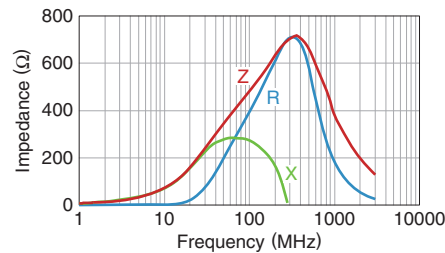

MMZ0603S601CT000

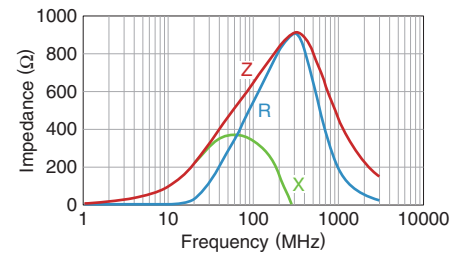

MMZ0603Y750CT000

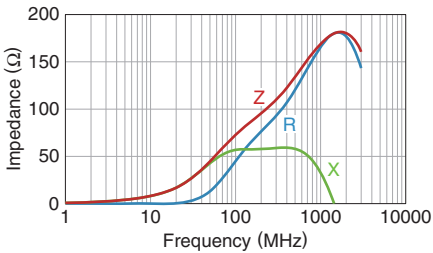

MMZ0603Y121CT000

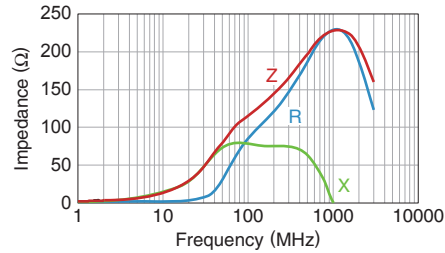

MMZ0603Y241CT000

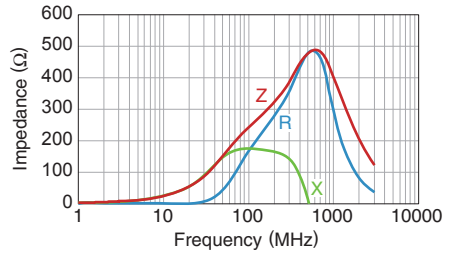

MMZ0603Y471CT000

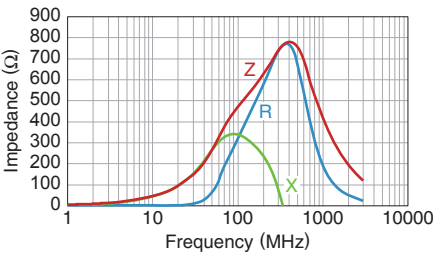

MMZ0603Y601CT000

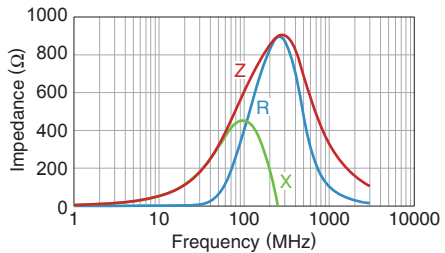

MMZ0603D330CT000

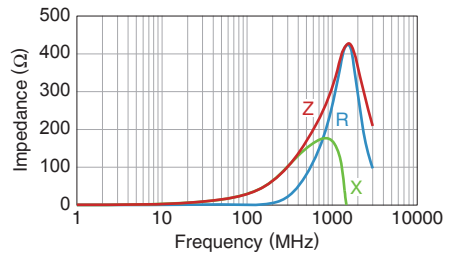

MMZ0603D470CT000

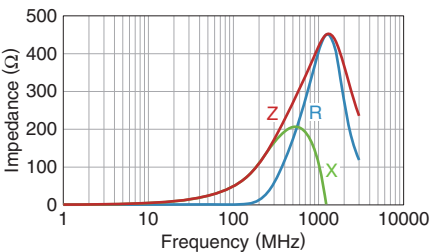

MMZ0603D560CT000

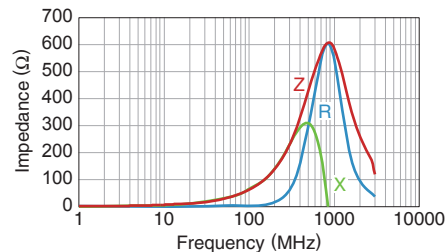

MMZ0603D800CT000

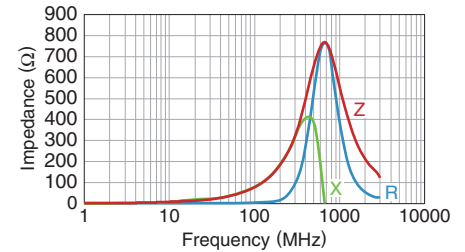

 Please be sure to request delivery specifications that provide further details on the features and specifications of the products for proper and safe use. Please note that the contents may change without any prior notice due to reasons such as upgrading.

MMZ0603 type

ELECTRICAL CHARACTERISTICS

Z, X, R VS. FREQUENCY CHARACTERISTICS

MMZ0603D121CT000

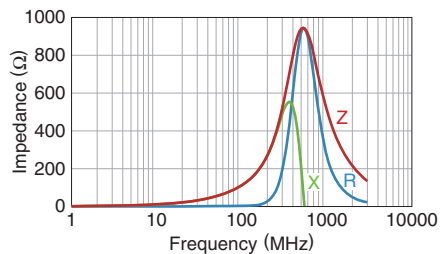

MMZ0603F100CT000

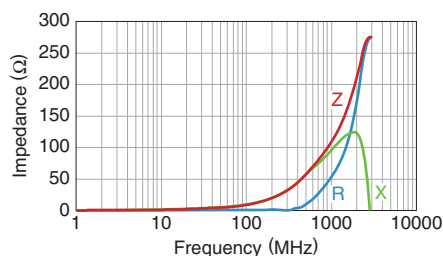

MMZ0603F220CT000

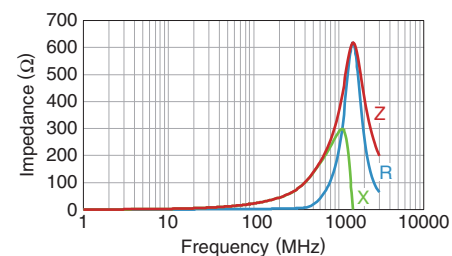

MMZ0603F330CT000

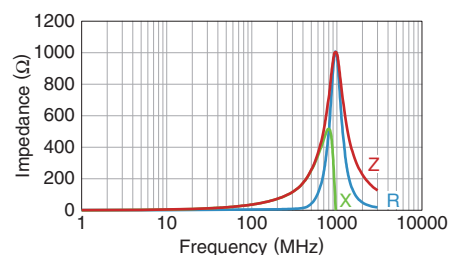

Please be sure to request delivery specifications that provide further details on the features and specifications of the products for proper and safe use. Please note that the contents may change without any prior notice due to reasons such as upgrading.

MMZ0603 type

PACKAGING STYLE

REEL DIMENSIONS

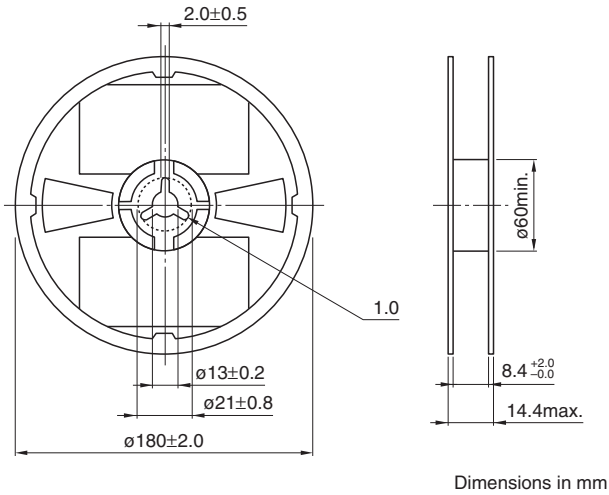

TAPE DIMENSIONS

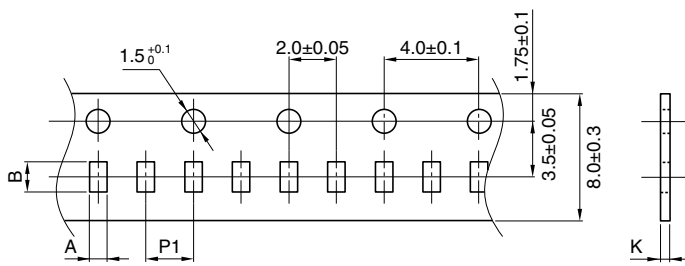

| Type | A | B | P1 | K |
|----------------|-----------------|-----------------|----------------|---------|
| MMZ0603 | 0.38 ± 0.05 | 0.68 ± 0.05 | 2.0 ± 0.05 | 0.5max. |

