

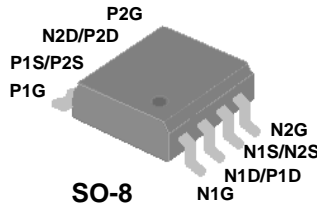

**Quad Complementary N and P-channel  
Enhancement-mode Power MOSFETs**

- Simple Drive Requirement
- Low On-resistance
- Full Bridge Applications
- RoHS-compliant, halogen-free



N-CH	$BV_{DSS}$	30V
	$R_{DS(ON)}$	33m $\Omega$
	$I_D$	5.5A
P-CH	$BV_{DSS}$	-30V
	$R_{DS(ON)}$	55m $\Omega$
	$I_D$	-4.1A

**Description**

Advanced Power MOSFETs from APEC provide the designer with the best combination of fast switching, low on-resistance and cost-effectiveness.

The AP9930GM-HF-3 is in a standard SO-8 package, which is widely used for commercial and industrial surface-mount applications, and is well suited for applications such as DC and servo motor drives.

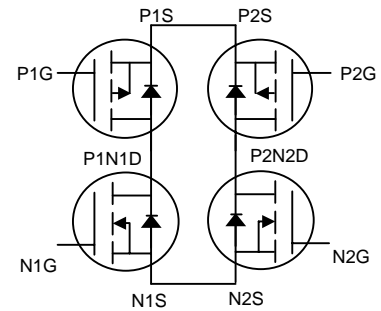

**Absolute Maximum Ratings**

Symbol	Parameter	Rating		Units
		N-channel	P-channel	
$V_{DS}$	Drain-Source Voltage	30	-30	V
$V_{GS}$	Gate-Source Voltage	$\pm 20$	$\pm 20$	V
$I_D$ at $T_A=25^\circ C$	Continuous Drain Current <sup>3</sup>	5.5	-4.1	A
$I_D$ at $T_A=70^\circ C$	Continuous Drain Current <sup>3</sup>	4.4	-3.3	A
$I_{DM}$	Pulsed Drain Current <sup>1</sup>	20	-20	A
$P_D$ at $T_A=25^\circ C$	Total Power Dissipation	1.38		W
	Linear Derating Factor	0.011		W/ $^\circ C$
$T_{STG}$	Storage Temperature Range	-55 to 150		$^\circ C$
$T_J$	Operating Junction Temperature Range	-55 to 150		$^\circ C$

**Thermal Data**

Symbol	Parameter	Value	Unit
$R_{thj-a}$	Maximum Thermal Resistance, Junction-ambient <sup>3</sup>	90	$^\circ C/W$

**Ordering Information**

**AP9930GM-HF-3TR** : in RoHS-compliant, halogen-free SO-8, shipped on tape and reel (3000 pcs/reel)



**N-channel Electrical Specifications at  $T_j=25^\circ\text{C}$  (unless otherwise specified)**

Symbol	Parameter	Test Conditions	Min.	Typ.	Max.	Units
$BV_{DSS}$	Drain-Source Breakdown Voltage	$V_{GS}=0V, I_D=250\mu A$	30	-	-	V
$R_{DS(ON)}$	Static Drain-Source On-Resistance <sup>2</sup>	$V_{GS}=10V, I_D=5A$	-	-	33	m $\Omega$
		$V_{GS}=4.5V, I_D=3A$	-	-	60	m $\Omega$
$V_{GS(th)}$	Gate Threshold Voltage	$V_{DS}=V_{GS}, I_D=250\mu A$	1	-	3	V
$g_{fs}$	Forward Transconductance	$V_{DS}=10V, I_D=5A$	-	5.2	-	S
$I_{DSS}$	Drain-Source Leakage Current	$V_{DS}=30V, V_{GS}=0V$	-	-	1	$\mu A$
	Drain-Source Leakage Current ( $T_j=70^\circ\text{C}$ )	$V_{DS}=24V, V_{GS}=0V$	-	-	25	$\mu A$
$I_{GSS}$	Gate-Source Leakage	$V_{GS}=\pm 20V$	-	-	$\pm 100$	nA
$Q_g$	Total Gate Charge <sup>2</sup>	$I_D=5A$	-	7	10	nC
$Q_{gs}$	Gate-Source Charge	$V_{DS}=15V$	-	2	-	nC
$Q_{gd}$	Gate-Drain ("Miller") Charge	$V_{GS}=4.5V$	-	4	-	nC
$t_{d(on)}$	Turn-on Delay Time <sup>2</sup>	$V_{DS}=15V$	-	7	-	ns
$t_r$	Rise Time	$I_D=1A$	-	10	-	ns
$t_{d(off)}$	Turn-off Delay Time	$R_G=6\Omega, V_{GS}=10V$	-	18	-	ns
$t_f$	Fall Time	$R_D=15\Omega$	-	8	-	ns
$C_{iss}$	Input Capacitance	$V_{GS}=0V$	-	600	960	pF
$C_{oss}$	Output Capacitance	$V_{DS}=25V$	-	229.8	-	pF
$C_{rss}$	Reverse Transfer Capacitance	$f=1.0\text{MHz}$	-	94	-	pF

**Source-Drain Diode**

Symbol	Parameter	Test Conditions	Min.	Typ.	Max.	Units
$V_{SD}$	Forward On Voltage <sup>2</sup>	$I_S=1.2A, V_{GS}=0V$	-	-	1.2	V
$t_{rr}$	Reverse Recovery Time <sup>2</sup>	$I_S=1.7A, V_{GS}=0V$	-	21	-	ns
$Q_{rr}$	Reverse Recovery Charge	$dI/dt=100A/\mu s$	-	16	-	nC

**Notes:**

1. Pulse width limited by maximum junction temperature.
2. Pulse width  $\leq 300\mu s$ , duty cycle  $\leq 2\%$ .
3. Surface mounted on 1 in<sup>2</sup> copper pad of FR4 board,  $t \leq 10\text{sec}$ ; 186°C/W when mounted on min. copper pad.

THIS PRODUCT IS SENSITIVE TO ELECTROSTATIC DISCHARGE, PLEASE HANDLE WITH CAUTION.

USE OF THIS PRODUCT AS A CRITICAL COMPONENT IN LIFE SUPPORT OR OTHER SIMILAR SYSTEMS IS NOT AUTHORIZED.

APEC DOES NOT ASSUME ANY LIABILITY ARISING OUT OF THE APPLICATION OR USE OF ANY PRODUCT OR CIRCUIT DESCRIBED HEREIN; NEITHER DOES IT CONVEY ANY LICENSE UNDER ITS PATENT RIGHTS, NOR THE RIGHTS OF OTHERS.

APEC RESERVES THE RIGHT TO MAKE CHANGES WITHOUT FURTHER NOTICE TO ANY PRODUCTS HEREIN TO IMPROVE RELIABILITY, FUNCTION OR DESIGN.



**P-channel Electrical Specifications at  $T_j=25^{\circ}\text{C}$  (unless otherwise specified)**

Symbol	Parameter	Test Conditions	Min.	Typ.	Max.	Units
$BV_{DSS}$	Drain-Source Breakdown Voltage	$V_{GS}=0V, I_D=-250\mu A$	-30	-	-	V
$R_{DS(ON)}$	Static Drain-Source On-Resistance <sup>2</sup>	$V_{GS}=-10V, I_D=-4A$	-	-	55	m $\Omega$
		$V_{GS}=-4.5V, I_D=-2A$	-	-	100	m $\Omega$
$V_{GS(th)}$	Gate Threshold Voltage	$V_{DS}=V_{GS}, I_D=-250\mu A$	-1	-	-3	V
$g_{fs}$	Forward Transconductance	$V_{DS}=-10V, I_D=-4A$	-	4	-	S
$I_{DSS}$	Drain-Source Leakage Current	$V_{DS}=-30V, V_{GS}=0V$	-	-	-1	$\mu A$
	Drain-Source Leakage Current ( $T_j=70^{\circ}\text{C}$ )	$V_{DS}=-24V, V_{GS}=0V$	-	-	-25	$\mu A$
$I_{GSS}$	Gate-Source Leakage	$V_{GS}=\pm 20V$	-	-	$\pm 100$	nA
$Q_g$	Total Gate Charge <sup>2</sup>	$I_D=-4A$	-	8	11	nC
$Q_{gs}$	Gate-Source Charge	$V_{DS}=-24V$	-	1.5	-	nC
$Q_{gd}$	Gate-Drain ("Miller") Charge	$V_{GS}=-4.5V$	-	4	-	nC
$t_{d(on)}$	Turn-on Delay Time <sup>2</sup>	$V_{DS}=-15V$	-	6.6	-	ns
$t_r$	Rise Time	$I_D=-1A$	-	7.7	-	ns
$t_{d(off)}$	Turn-off Delay Time	$R_G=3.3\Omega, V_{GS}=-10V$	-	22	-	ns
$t_f$	Fall Time	$R_D=15\Omega$	-	9.3	-	ns
$C_{iss}$	Input Capacitance	$V_{GS}=0V$	-	570	790	pF
$C_{oss}$	Output Capacitance	$V_{DS}=-25V$	-	80	-	pF
$C_{rss}$	Reverse Transfer Capacitance	$f=1.0\text{MHz}$	-	75	-	pF

**Source-Drain Diode**

Symbol	Parameter	Test Conditions	Min.	Typ.	Max.	Units
$V_{SD}$	Forward On Voltage <sup>2</sup>	$I_S=-1.2A, V_{GS}=0V$	-	-	-1.2	V
$t_{rr}$	Reverse Recovery Time <sup>2</sup>	$I_S=-4A, V_{GS}=0V,$	-	18	-	ns
$Q_{rr}$	Reverse Recovery Charge	$di/dt=100A/\mu s$	-	10	-	nC

**Notes:**

1. Pulse width limited by maximum junction temperature.
2. Pulse width  $\leq 300\mu s$ , duty cycle  $\leq 2\%$ .
3. Surface mounted on 1 in<sup>2</sup> copper pad of FR4 board,  $t \leq 10\text{sec}$ ; 186 $^{\circ}\text{C}/\text{W}$  when mounted on min. copper pad.

THIS PRODUCT IS SENSITIVE TO ELECTROSTATIC DISCHARGE, PLEASE HANDLE WITH CAUTION.

USE OF THIS PRODUCT AS A CRITICAL COMPONENT IN LIFE SUPPORT OR OTHER SIMILAR SYSTEMS IS NOT AUTHORIZED.

APEC DOES NOT ASSUME ANY LIABILITY ARISING OUT OF THE APPLICATION OR USE OF ANY PRODUCT OR CIRCUIT DESCRIBED HEREIN; NEITHER DOES IT CONVEY ANY LICENSE UNDER ITS PATENT RIGHTS, NOR THE RIGHTS OF OTHERS.

APEC RESERVES THE RIGHT TO MAKE CHANGES WITHOUT FURTHER NOTICE TO ANY PRODUCTS HEREIN TO IMPROVE RELIABILITY, FUNCTION OR DESIGN.



Typical N-channel Electrical Characteristics

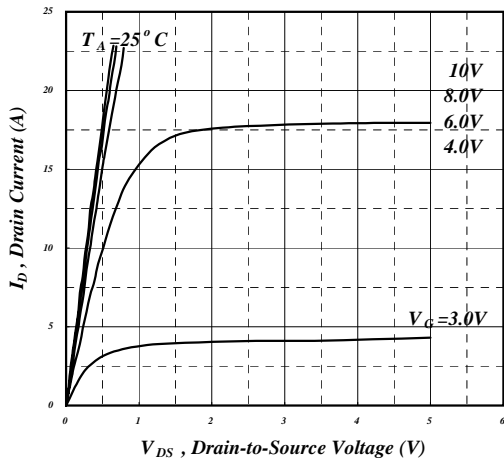

Fig 1. Typical Output Characteristics

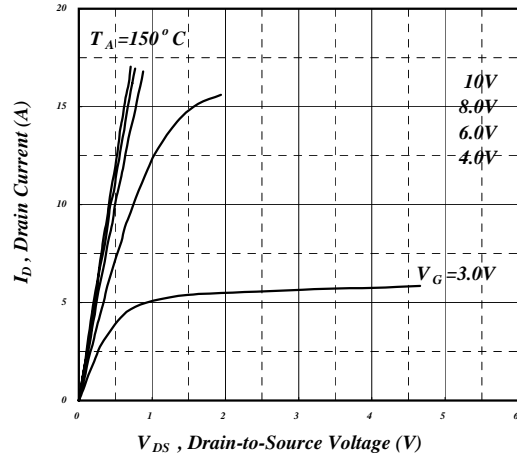

Fig 2. Typical Output Characteristics

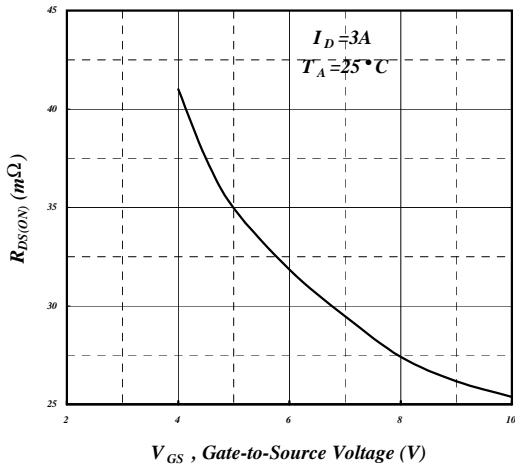

Fig 3. On-Resistance vs. Gate Voltage

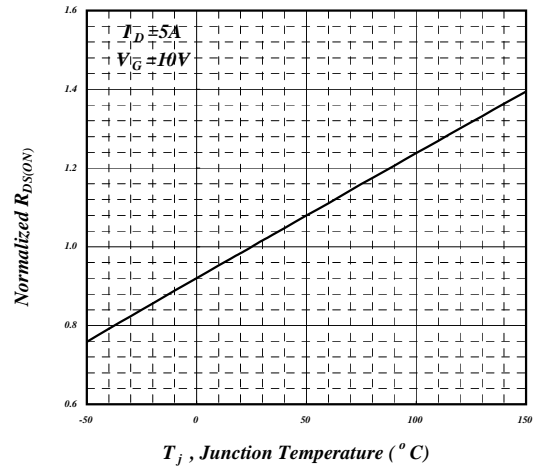

Fig 4. Normalized On-Resistance vs. Junction Temperature

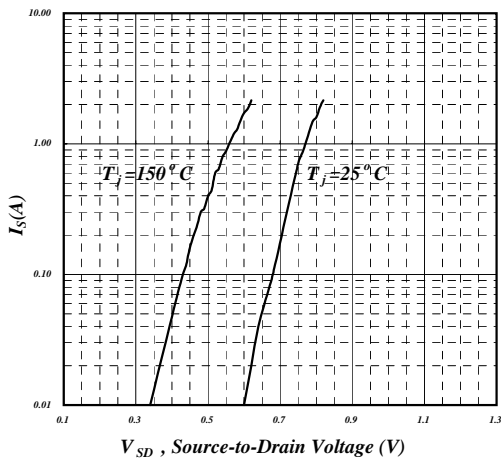

Fig 5. Forward Characteristic of Reverse Diode

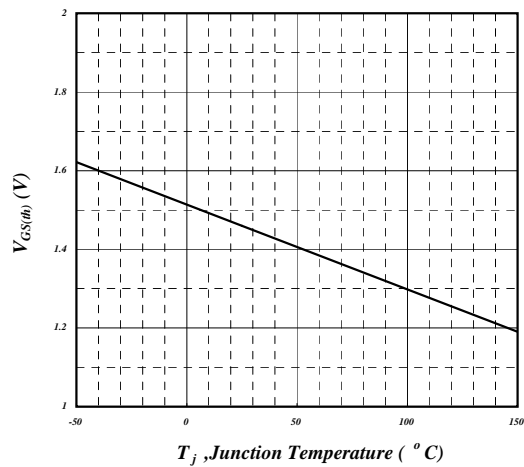

Fig 6. Gate Threshold Voltage vs. Junction Temperature



Typical N-channel Electrical Characteristics (cont.)

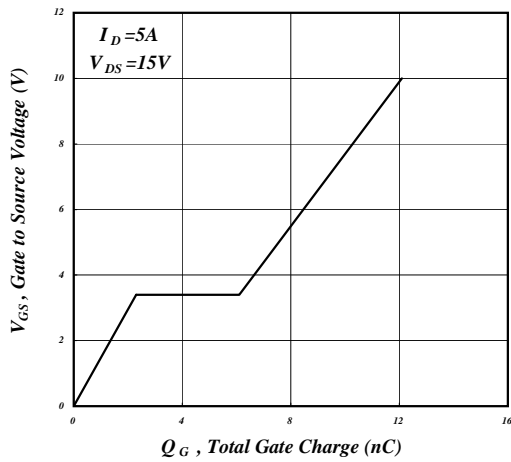

Fig 7. Gate Charge Characteristics

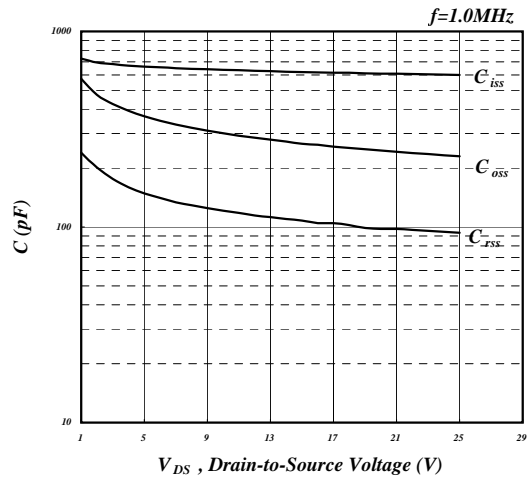

Fig 8. Typical Capacitance Characteristics

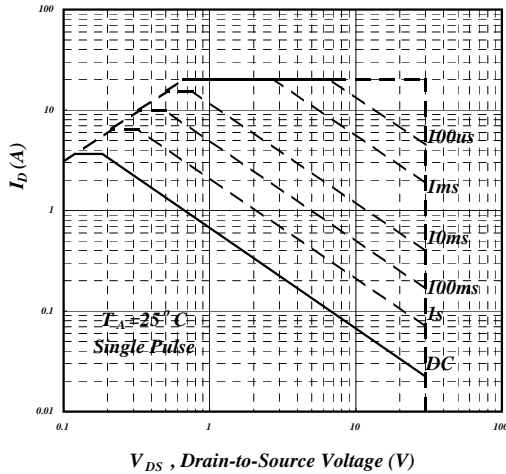

Fig 9. Maximum Safe Operating Area

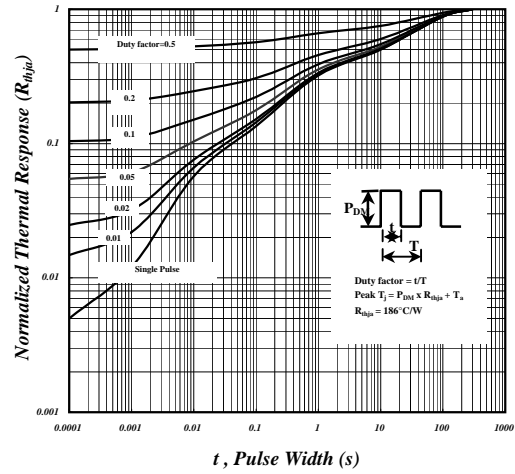

Fig 10. Effective Transient Thermal Impedance

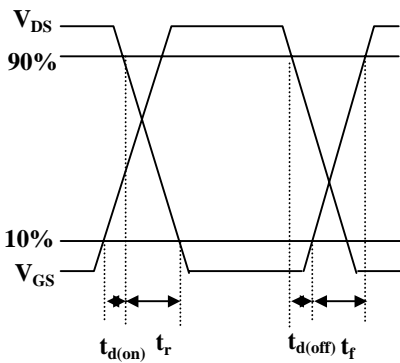

Fig 11. Switching Time Waveforms

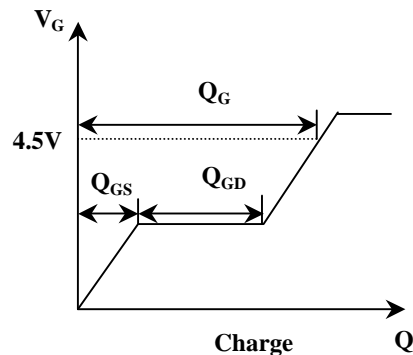

Fig 12. Gate Charge Waveform



Typical P-channel Electrical Characteristics

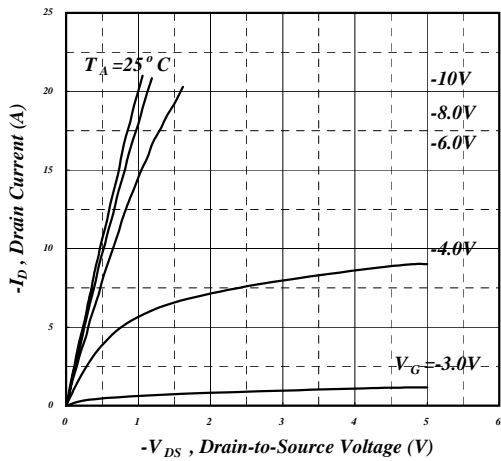

Fig 1. Typical Output Characteristics

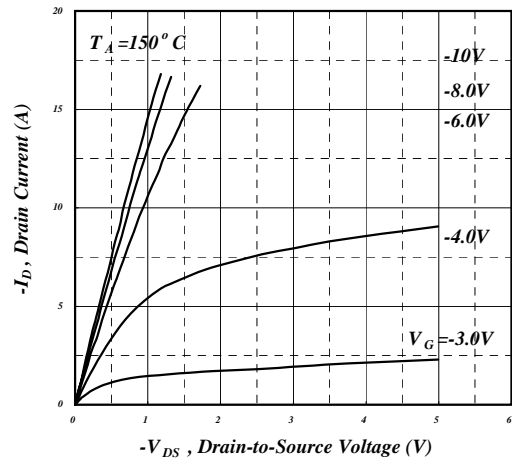

Fig 2. Typical Output Characteristics

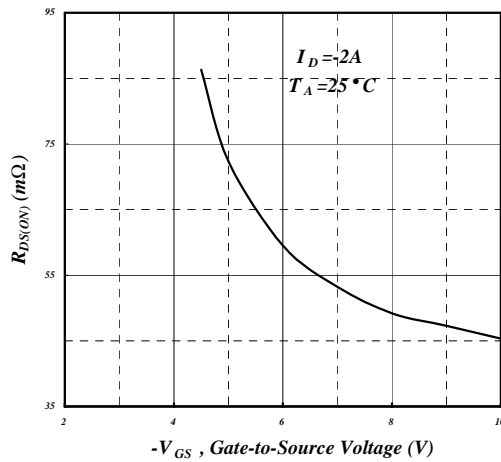

Fig 3. On-Resistance vs. Gate Voltage

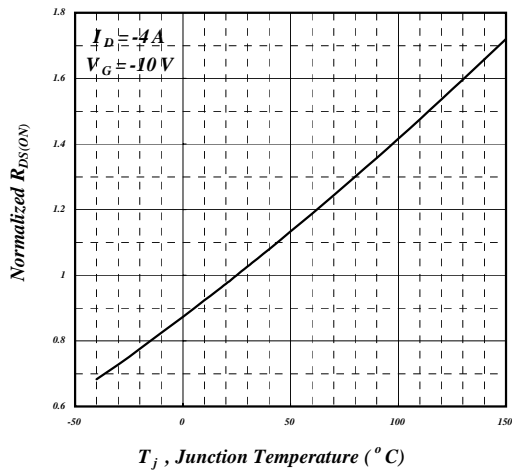

Fig 4. Normalized On-Resistance vs. Junction Temperature

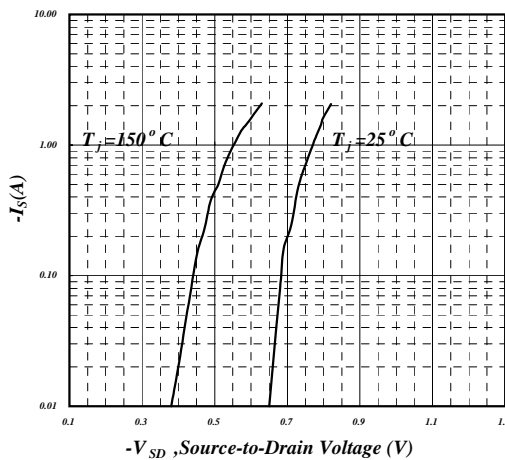

Fig 5. Forward Characteristic of Reverse Diode

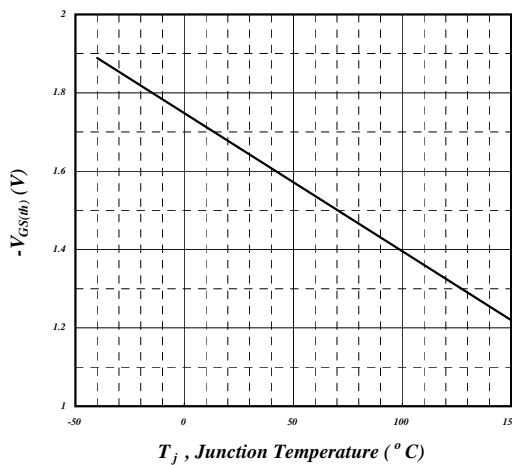

Fig 6. Gate Threshold Voltage vs. Junction Temperature



Typical P-channel Electrical Characteristics (cont.)

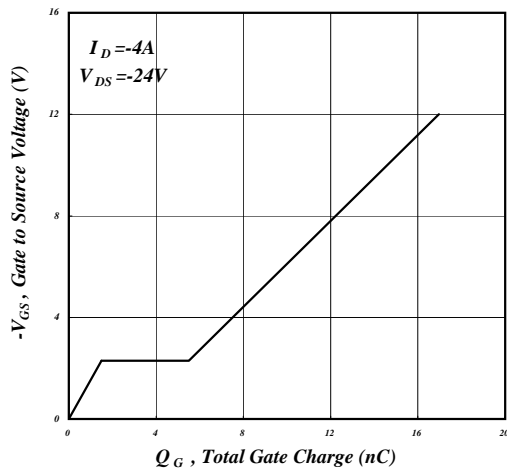

Fig 7. Gate Charge Characteristics

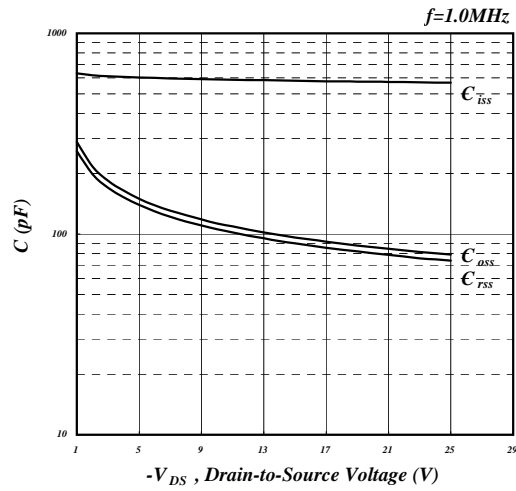

Fig 8. Typical Capacitance Characteristics

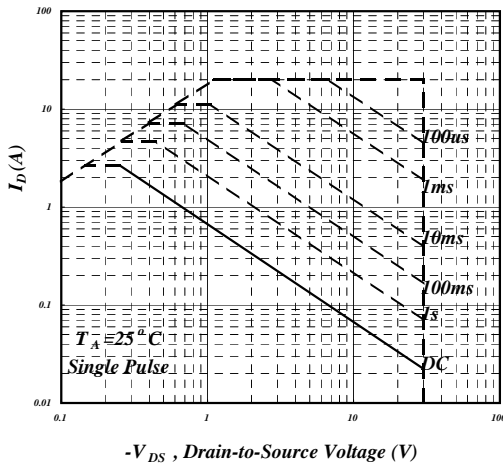

Fig 9. Maximum Safe Operating Area

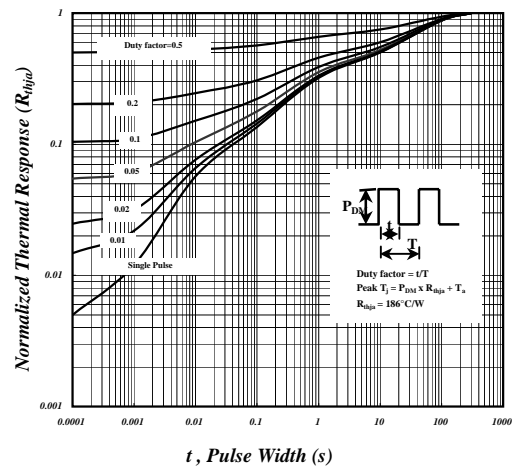

Fig 10. Effective Transient Thermal Impedance

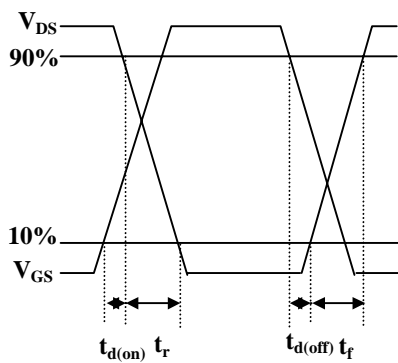

Fig 11. Switching Time Waveforms

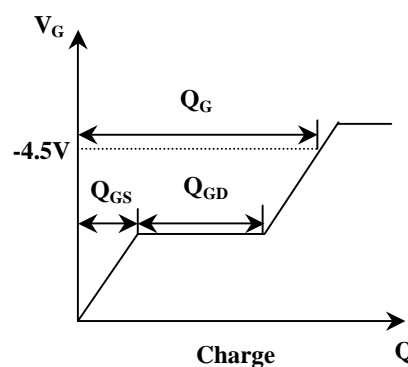
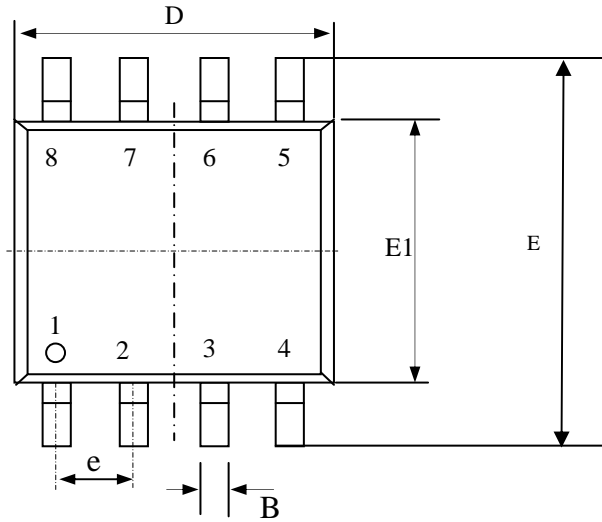

Fig 12. Gate Charge Waveform



**Package Dimensions: SO-8**



SYMBOLS	Millimeters		
	MIN	NOM	MAX
A	1.35	1.55	1.75
A1	0.10	0.18	0.25
B	0.33	0.41	0.51
C	0.19	0.22	0.25
D	4.80	4.90	5.00
E1	3.80	3.90	4.00
E	5.80	6.15	6.50
L	0.38	0.71	1.27
$\theta$	0	4.00	8.00
e	1.27 TYP		

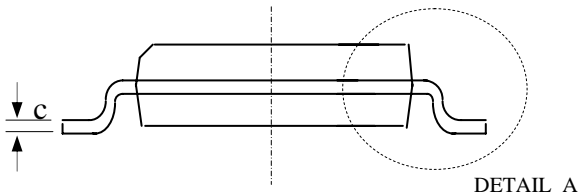
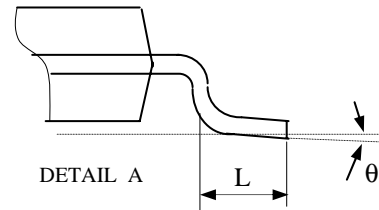
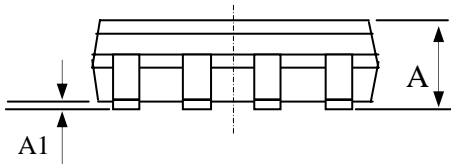

1. All dimensions are in millimeters.
2. Dimensions do not include mold protrusions.

**Marking Information:**

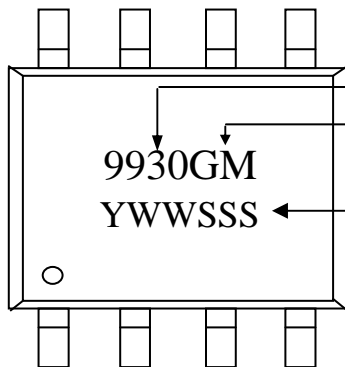

Product: AP9930  
 Package:  
 GM = RoHS-compliant halogen-free SO-8  
 Date/lot code (YWWSSS)  
 Y: Last digit of the year  
 WW: Work week  
 SSS: Lot code sequence



## **X-ON Electronics**

Largest Supplier of Electrical and Electronic Components

*Click to view similar products for [advanced power manufacturer](#):*

Other Similar products are found below :

[AP50T10GH](#) [AP9923GEO-HF](#) [AP2P053N](#) [AP9575GP-HF](#) [AP10TN135N](#) [APT802R8KN](#) [AP83T03GH](#) [AP9410GH-HF](#) [AP2311GN](#)  
[AP4439GM](#) [AP40N03GP](#) [AP4953GM](#) [AP9987GH](#) [AP9T18GH-HF](#) [AP09N70I-A](#) [AP8600S](#) [AP04N70BI-A](#) [AP30T10GM-HF](#) [AP9985GM-](#)  
[HF](#) [AP3P050M](#) [AP9990GH-HF](#) [AP9T16AGH-HF](#) [AP4920GM](#) [AP2320GN](#) [AP4451GYT-HF](#) [AP4034GYT-HF](#) [AP65SL380DH](#)  
[AP2323GN-HF](#) [AP83T03GM](#) [AP9870GH](#) [AP3P3R0MT](#) [AP2305GN-HF](#) [AP6679GH-HF](#) [AP4435GM-HF](#) [AP2306GN-HF](#)