

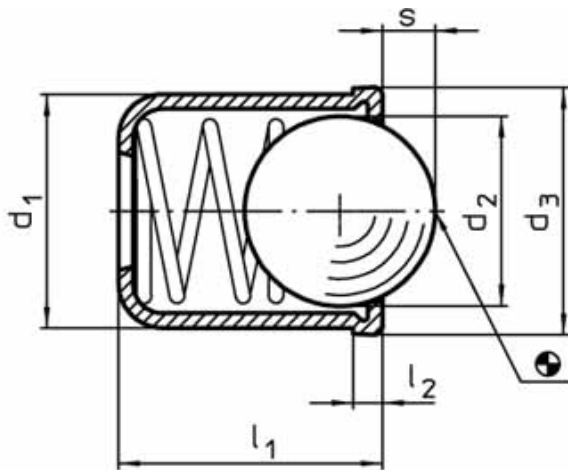

Part Number : 3230















Material and Technical Notes

Body: stainless steel 1.4305, brass, or Delrin blue. Ball: stainless steel, hardened or Delrin white (POM). Spring: stainless steel.

Used for locating, applying pressure or lifting off. Spring loads * = statistical average values.

These are press fit spring plungers. Typical hole tolerance is J6, but this varies with type of material so a trial hole is recommended.

Order No.	Finish	d ₁ +0,1	d ₂	d ₃	l ₁	l ₂	s	Spring Load*		max. ° C	g
								F ₁ N α	F ₂ N α		
ORDER/PRICE 3230.W004	Body & ball Stainless steel	4	3,0	4,6	5,0	1,5	0,8	2,5	6,0	250	0,35
ORDER/PRICE 3230.W005	Body & ball Stainless steel	5	4,0	5,6	6,0	1,5	1,0	3,0	6,5	250	0,60
ORDER/PRICE 3230.W006	Body & ball stainless steel	6	5,0	6,5	7,0	1,5	1,6	5,5	11,5	250	1,00
ORDER/PRICE 3230.W008	Body & ball stainless steel	8	6,5	8,5	9,0	1,5	1,9	7,0	12,5	250	2,20
ORDER/PRICE 3230.W010	Body & ball stainless	10	8,5	11,0	13,5	2,5	3,1	8,5	18,5	250	5,30

		steel											
 ORDER/PRICE	3230.W012	Body & ball stainless steel	12	10,0	13,0	16,0	2,5	3,8	12,0	26,5	250	7,80	
 ORDER/PRICE	3230.W204	Body: brass, ball stainless steel	4	2,5	4,5	5,0	1,0	0,8	2,5	6,0	250	0,45	
 ORDER/PRICE	3230.W205	Body brass, ball stainless steel	5	3,5	5,5	6,0	1,0	1,0	3,0	6,5	250	0,80	
 ORDER/PRICE	3230.W206	Body brass, ball stainless steel	6	4,5	6,5	7,0	1,0	1,6	5,5	11,5	250	1,30	
 ORDER/PRICE	3230.W208	Body brass, ball stainless steel	8	6,0	8,5	9,0	1,0	1,9	7,0	12,5	250	2,90	
 ORDER/PRICE	3230.W404	Body Delrin, ball stainless steel	4	3,0	4,6	5,0	1,0	0,8	2,5	6,5	-0,6	0,20	
 ORDER/PRICE	3230.W405	Body Delrin, ball stainless steel	5	4,0	5,6	6,0	1,0	1,0	4,5	9,0	-0,6	0,40	
 ORDER/PRICE	3230.W406	Body Delrin, ball stainless steel	6	5,0	6,5	7,0	1,0	1,6	6,5	13,0	-0,6	0,70	
 ORDER/PRICE	3230.W408	Body Delrin, ball stainless steel	8	6,5	8,5	9,0	1,0	1,9	8,0	18,0	-0,6	1,50	
 ORDER/PRICE	3230.W604	Body & ball Delrin	4	3,0	4,6	5,0	1,0	0,8	2,5	6,5	-0,6	0,10	
 ORDER/PRICE	3230.W605	Body & ball Delrin	5	4,0	5,6	6,0	1,0	1,0	4,5	9,0	-0,6	0,20	
 ORDER/PRICE	3230.W606	Body & ball Delrin	6	5,0	6,5	7,0	1,0	1,6	6,5	13,0	-0,6	0,30	

 ORDER/PRICE	3230.W608	Body & ball Delrin	8	6,5	8,5	9,0	1,0	1,9	8,0	18,0	-0.6	0,55
--	------------------	---------------------------------------	----------	------------	------------	------------	------------	------------	------------	-------------	-------------	-------------



X-ON Electronics

Largest Supplier of Electrical and Electronic Components

Click to view similar products for [wixroyd](#) manufacturer:

Other Similar products are found below :

[3215.W105](#)