

## Active infrared (area reflective) human detection sensor MA MOTION SENSOR

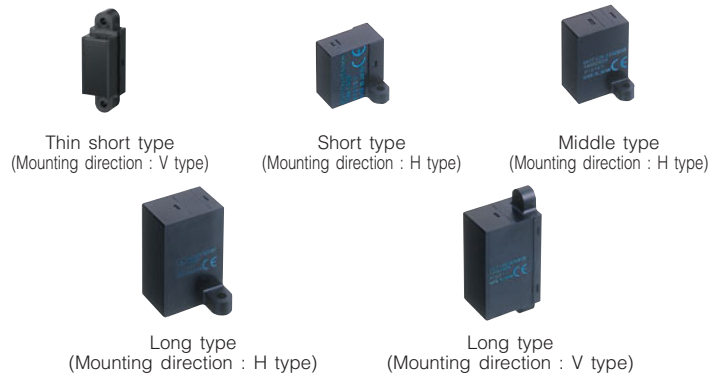

### Features

- Reliable detection hardly influenced by reflectivity of targeted objects
- Ready-to-use with DC power source (built-in oscillation circuit type)
- Capability to adjoin sensors
- RoHS compliant

### Typical Applications

- Equipment around water: automatic lighting of wash-units, toilets, automatic flush
- Stores and financial markets: automatic doors, lighting, ATM, visitor sensors
- Amusement equipment: seating detection for pachinko machines, game displays
- Medical equipment markets: noncontact switches

### Ordering Information

#### AM

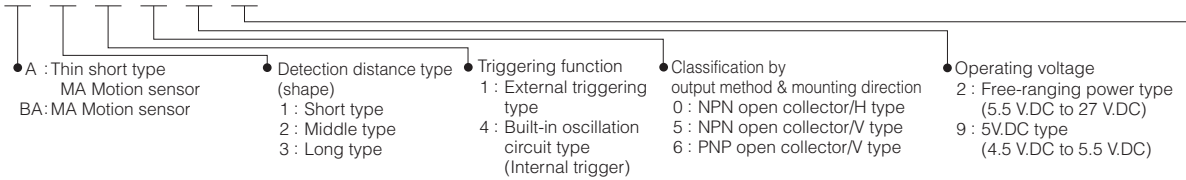

● Rated detection distance

Unit : cm inch

Part No.	02	03	04	05	06	07	08 (Middle type does not need 08)	09	10 (Short type does not need 10)	11	12	13	14	15	16	17	18	19	20 (Long type does not need 20)
Thin short type	-	-	-	5 1.969	-	-	-	-	10 3.937	-	-	-	-	15 5.906	-	-	-	-	-
Short type	-	-	-	5 1.969	6 2.362	7 2.756	8 3.150	9 3.543	10 3.937	-	-	-	-	-	-	-	-	-	-
Middle type	20 7.874	30 11.811	40 15.748	50 19.685	60 23.622	70 27.559	80 31.496	-	-	-	-	-	-	-	-	-	-	-	-
Long type	-	30 11.811	40 15.748	50 19.685	60 23.622	70 27.559	80 31.496	90 35.443	100 39.37	110 43.307	120 47.244	130 51.181	140 55.118	150 59.055	160 62.992	170 66.929	180 70.866	190 74.803	200 78.74

## Product Types

- Detection distance type (distance limited)
  - 1) Thin short type (V type)

Standard packing: Carton: 20 pcs.; Case: 200 pcs.

Operating voltage	Output method	Rated detection distance	Built-in oscillation circuit type	External triggering type
			Part No.	Part No.
4.5 V.DC to 5.5 V.DC	NPN open collector output	5 cm 1.969 inch	AMA145905	AMA115905
		10 cm 3.937 inch	AMA1459	AMA1159
		15 cm 5.906 inch	AMA145915	AMA115915
	PNP open collector output	5 cm 1.969 inch	AMA146905	AMA116905
		10 cm 3.937 inch	AMA1469	AMA1169
		15 cm 5.906 inch	AMA146915	AMA116915

Note: If using multiple sensors adjacently or reducing power consumption, contact us for the optimal external trigger type.

### 2) Short type (H type)

Standard packing: Carton: 20 pcs.; Case: 200 pcs.

Rated operating voltage	Rated detection distance	Mounting direction : H type	
		Short type	
		Built-in oscillation circuit type	External triggering type
		Part No.	Part No.
4.5 V.DC to 5.5 V.DC	5 cm 1.969 inch	AMBA140905	AMBA110905
	6 cm 2.362 inch	AMBA140906	AMBA110906
	7 cm 2.756 inch	AMBA140907	AMBA110907
	8 cm 3.150 inch	AMBA140908	AMBA110908
	9 cm 3.543 inch	AMBA140909	AMBA110909
	10 cm 3.937 inch	AMBA1409	AMBA1109
5.5 V.DC to 27 V.DC	5 cm 1.969 inch	AMBA140205	AMBA110205
	6 cm 2.362 inch	AMBA140206	AMBA110206
	7 cm 2.756 inch	AMBA140207	AMBA110207
	8 cm 3.150 inch	AMBA140208	AMBA110208
	9 cm 3.543 inch	AMBA140209	AMBA110209
	10 cm 3.937 inch	AMBA1402	AMBA1102

Note: If using multiple sensors adjacently or reducing power consumption, contact us for the optimal external trigger type.

### 3) Middle type (H type)

Standard packing: Carton: 20 pcs.; Case: 200 pcs.

Rated operating voltage	Rated detection distance	Mounting direction : H type	
		Middle type	
		Built-in oscillation circuit type	External triggering type
		Part No.	Part No.
4.5 V.DC to 5.5 V.DC	20 cm 7.874 inch	AMBA240902	AMBA210902
	30 cm 11.811 inch	AMBA240903	AMBA210903
	40 cm 15.748 inch	AMBA240904	AMBA210904
	50 cm 19.685 inch	AMBA240905	AMBA210905
	60 cm 23.622 inch	AMBA240906	AMBA210906
	70 cm 27.559 inch	AMBA240907	AMBA210907
	80 cm 31.496 inch	AMBA2409	AMBA2109
5.5 V.DC to 27 V.DC	20 cm 7.874 inch	AMBA240202	AMBA210202
	30 cm 11.811 inch	AMBA240203	AMBA210203
	40 cm 15.748 inch	AMBA240204	AMBA210204
	50 cm 19.685 inch	AMBA240205	AMBA210205
	60 cm 23.622 inch	AMBA240206	AMBA210206
	70 cm 27.559 inch	AMBA240207	AMBA210207
	80 cm 31.496 inch	AMBA2402	AMBA2102

Note: If using multiple sensors adjacently or reducing power consumption, contact us for the optimal external trigger type.

## 4) Long type

Standard packing: Carton: 20 pcs.; Case: 200 pcs.

Rated operating voltage	Rated detection distance	Mounting direction : H type		Mounting direction: V type	
		Long type			
		Built-in oscillation circuit type	External triggering type	Built-in oscillation circuit type	External triggering type
		Part No.	Part No.	Part No.	Part No.
4.5 V.DC to 5.5 V.DC	30 cm 11.811 inch	AMBA340903	AMBA310903	AMBA345903	AMBA315903
	40 cm 15.748 inch	AMBA340904	AMBA310904	AMBA345904	AMBA315904
	50 cm 19.685 inch	AMBA340905	AMBA310905	AMBA345905	AMBA315905
	60 cm 23.622 inch	AMBA340906	AMBA310906	AMBA345906	AMBA315906
	70 cm 27.559 inch	AMBA340907	AMBA310907	AMBA345907	AMBA315907
	80 cm 31.496 inch	AMBA340908	AMBA310908	AMBA345908	AMBA315908
	90 cm 35.433 inch	AMBA340909	AMBA310909	AMBA345909	AMBA315909
	100 cm 39.370 inch	AMBA340910	AMBA310910	AMBA345910	AMBA315910
	110 cm 43.307 inch	AMBA340911	AMBA310911	AMBA345911	AMBA315911
	120 cm 47.244 inch	AMBA340912	AMBA310912	AMBA345912	AMBA315912
	130 cm 51.181 inch	AMBA340913	AMBA310913	AMBA345913	AMBA315913
	140 cm 55.118 inch	AMBA340914	AMBA310914	AMBA345914	AMBA315914
	150 cm 59.055 inch	AMBA340915	AMBA310915	AMBA345915	AMBA315915
	160 cm 62.992 inch	AMBA340916	AMBA310916	AMBA345916	AMBA315916
	170 cm 66.929 inch	AMBA340917	AMBA310917	AMBA345917	AMBA315917
	180 cm 70.866 inch	AMBA340918	AMBA310918	AMBA345918	AMBA315918
190 cm 74.803 inch	AMBA340919	AMBA310919	AMBA345919	AMBA315919	
200 cm 78.740 inch	AMBA3409	AMBA3109	AMBA3459	AMBA3159	
5.5 V.DC to 27 V.DC	30 cm 11.811 inch	AMBA340203	AMBA310203	AMBA345203	AMBA315203
	40 cm 15.748 inch	AMBA340204	AMBA310204	AMBA345204	AMBA315204
	50 cm 19.685 inch	AMBA340205	AMBA310205	AMBA345205	AMBA315205
	60 cm 23.622 inch	AMBA340206	AMBA310206	AMBA345206	AMBA315206
	70 cm 27.559 inch	AMBA340207	AMBA310207	AMBA345207	AMBA315207
	80 cm 31.496 inch	AMBA340208	AMBA310208	AMBA345208	AMBA315208
	90 cm 35.433 inch	AMBA340209	AMBA310209	AMBA345209	AMBA315209
	100 cm 39.370 inch	AMBA340210	AMBA310210	AMBA345210	AMBA315210
	110 cm 43.307 inch	AMBA340211	AMBA310211	AMBA345211	AMBA315211
	120 cm 47.244 inch	AMBA340212	AMBA310212	AMBA345212	AMBA315212
	130 cm 51.181 inch	AMBA340213	AMBA310213	AMBA345213	AMBA315213
	140 cm 55.118 inch	AMBA340214	AMBA310214	AMBA345214	AMBA315214
	150 cm 59.055 inch	AMBA340215	AMBA310215	AMBA345215	AMBA315215
	160 cm 62.992 inch	AMBA340216	AMBA310216	AMBA345216	AMBA315216
	170 cm 66.929 inch	AMBA340217	AMBA310217	AMBA345217	AMBA315217
	180 cm 70.866 inch	AMBA340218	AMBA310218	AMBA345218	AMBA315218
190 cm 74.803 inch	AMBA340219	AMBA310219	AMBA345219	AMBA315219	
200 cm 78.740 inch	AMBA3402	AMBA3102	AMBA3452	AMBA3152	

Note: If using multiple sensors adjacently or reducing power consumption, contact us for the optimal external trigger type.

## Rating

### ● Detection performance

1) Thin short type (Measuring conditions: ambient temp. : 25 °C 77 °F; operating voltage : 5 V.DC)

Items		Unit	Thin short type			Measured conditions	
		cm inch	5 1.969	10 3.937	15 3.937		
Rated detection distance	Minimum	mm inch	45 1.772	90 3.543	135 5.315	with a standard reflection board *1	
	Typical		50 1.969	100 3.937	150 5.906		
	Maximum		55 2.165	110 4.331	165 6.496		
Measuring tolerance		Typical	%	10	25	35	Reflection rate: 90 % to 18 %
Usable ambient brightness (Resistance to ambient light) *2	Brightness of sensor surface	Maximum	lx	30,000			See the drawing (Fig. 1) on the Brightness next page.
	Brightness of reflection surface			24,000			

Notes : \*1. Ambient brightness: 500 lx

\*2. Prevent direct light (within 30 ° against the optical axis of the sensor) from entering into the sensor.

2) Short type (Measuring conditions : ambient temp.: 25 °C 77 °F; operating voltage: 5 V.DC type 5 V.DC, Free-ranging power type 24 V.DC)

Items		Unit		Short type *1					Measured conditions
		cm	inch	5	6	7	8	9	
Rated detection distance	Minimum	mm inch	45	54	63	72	81	90	with a standard reflection board
	Typical		1.772	2.126	2.480	2.835	3.189	3.543	
	Maximum		50	60	70	80	90	100	
Measuring tolerance		Typical	%	10	15	20	25	Reflection rate: 90 % to 18 %	
Usable ambient brightness (Resistance to ambient light) *2	Brightness of sensor surface	Maximum	lx	30,000					See the drawing (Fig. 1) on the next page.
	Brightness of reflection surface	Maximum		24,000					

Notes : \*1. After the order receipt, the average rated detecting distance can be increased to max 15 cm 5.906 inch. Please consult us.

\*2. Prevent direct light (within 30 ° against the optical axis of the sensor) from entering into the sensor.

3) Middle type (Measuring conditions: ambient temp.: 25 °C 77 °F; operating voltage: 5 V.DC type 5 V.DC, Free-ranging power type 24 V.DC)

Items		Unit		Middle type *1					Measured conditions	
		cm	inch	20	30	40	50	60		70
Rated detection distance	Minimum	mm inch	190	285	380	475	570	665	760	with a standard reflection board
	Typical		7.480	11.220	14.961	18.701	22.441	26.181	29.921	
	Maximum		200	300	400	500	600	700	800	
Measuring tolerance		Typical	%	3	5	10	Reflection rate: 90 % to 18 %			
Usable ambient brightness (Resistance to ambient light) *2	Brightness of sensor surface	Maximum	lx	30,000					See the drawing (Fig. 1) on the next page.	
	Brightness of reflection surface	Maximum		24,000						

Notes : \*1. After the order receipt, the average rated detecting distance can be increased to max 110 cm 43.307 inch. Please consult us.

\*2. Prevent direct light (within 30 ° against the optical axis of the sensor) from entering into the sensor.

4) Long type (Measuring conditions: ambient temp.: 25 °C 77 °F; operating voltage: 5 V.DC type 5 V.DC, Free-ranging power type 24 V.DC)

Items		Unit		Long type							Measured conditions	
		cm	inch	30	40	50	60	70	80	90		100
Rated detection distance	Minimum	mm inch	285	380	475	570	665	760	855	950	1045	with a standard reflection board
	Typical		11.220	14.961	18.701	22.441	26.181	29.921	33.661	37.402	41.142	
	Maximum		300	400	500	600	700	800	900	1000	1100	
Measuring tolerance		Typical	%	3	5	Reflection rate: 90 % to 18 %						
Usable ambient brightness (Resistance to ambient light) *	Brightness of sensor surface	Maximum	lx	30,000							See the drawing (Fig. 1) on the next page.	
	Brightness of reflection surface	Maximum		24,000								

Items		Unit		Long type							Measured conditions	
		cm	inch	120	130	140	150	160	170	180		190
Rated detection distance	Minimum	mm inch	1140	1235	1330	1425	1520	1615	1710	1805	1900	with a standard reflection board
	Typical		44.882	48.622	52.362	56.102	59.842	63.583	67.323	71.063	74.803	
	Maximum		1200	1300	1400	1500	1600	1700	1800	1900	2000	
Measuring tolerance		Typical	%	5	10	15	Reflection rate: 90 % to 18 %					
Usable ambient brightness (Resistance to ambient light) *	Brightness of sensor surface	Maximum	lx	30,000							See the drawing (Fig. 1) on the next page.	
	Brightness of reflection surface	Maximum		24,000								

Notes : \* Prevent direct light (within 30 ° against the optical axis of the sensor) from entering into the sensor.

- For thin short type:  
Standard reflection board : 150 mm 5.906 inch square area, 90% reflection rate.
- For short type:  
Standard reflection board: 100 mm 3.937 inch square area, 90% reflection rate.
- For middle type:  
Standard reflection board: 200 mm 7.874 inch square area, 90% reflection rate.
- For long type:  
Standard reflection board: 500 mm 19.685 inch square area, 90% reflection rate.

Notes : 1. Detecting an object within the maximum preset detection distance.

$$2. \text{Distance deviation} = \frac{a-b}{a} \times 100 (\%)$$

(a: detection distance of detection target with reflectance of 90 %.  
b: detection distance of standard detection target with reflectance of 18 %.)

<Fig. 1>

[Brightness of sensor surface]

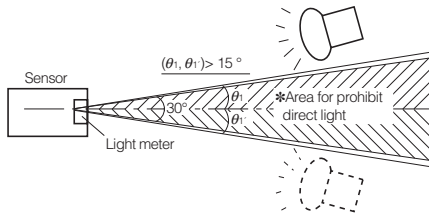

Notes : If sunlight or strobe/inverter light (including the regular reflection light from glasses and mirrors) directly enters from the inhibition area, those lights may cause malfunction of the sensor(sensor) from entering into the sensor.

[Brightness of reflection surface]

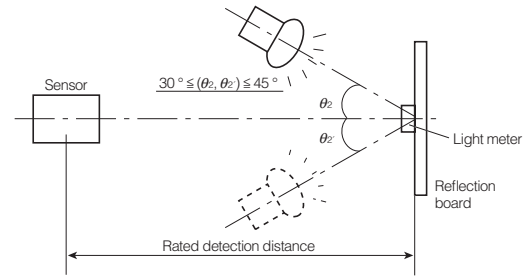

## Absolute maximum rating

- Measuring condition: ambient temp.: 25 °C 77 °F

Items	Absolute maximum rating			
	Built-in oscillation circuit type		External triggering type	
	5 V.DC type	Free-ranging power type	5 V.DC type	Free-ranging power type
Power supply voltage	-0.3 V.DC to 6 V.DC	-0.3 V.DC to 30 V.DC	-0.3 V.DC to 6 V.DC	-0.3 V.DC to 30 V.DC
Output dielectric strength	30 V.DC		30 V.DC	
Output flow current	100 mA		10 mA*	
Usable ambient temperature	-25 °C to +75 °C +5 °F to +131 °F (No freezing)		-25 °C to +75 °C +5 °F to +131 °F (No freezing)	
Storage temperature	-30 °C to +85 °C -4 °F to +176 °F		-30 °C to +85 °C -4 °F to +176 °F	

Notes : \* Thin short type is only: 100 mA

## Electrical characteristics

- Measuring conditions : ambient temp.: 25 °C 77 °F, operating voltage: 5 V.DC type, free-ranging power type 24 V.DC
- 1) Built-in oscillation circuit type

Items	Symbol	Thin short type*		Short type	Middle type	Long type	Measured conditions	
		NPN output type	PNP output type					
Rated operating voltage	Minimum	5 V.DC type : 4.5V.DC / Free-ranging power type : 5.5 V.DC						
	Typical	-						
	Maximum	5 V.DC type : 5.5 V.DC /Free-ranging power type : 27 V.DC						
Average current consumption (I <sub>out</sub> =0 mA)	No detection	Minimum	-					
		Typical	4.5 mA		5 V.DC type : 4.5 mA Free-ranging power type : 5.6 mA			
		Maximum	6.2 mA		5 V.DC type : 6.2 mA Free-ranging power type : 7.8 mA			
	Detection	Minimum	-					
		Typical	7.0 mA	11.0 mA	5 V.DC type : 7.0 mA Free-ranging power type : 9.1 mA			
		Maximum	11.2 mA	15.2 mA	5 V.DC type : 11.2 mA Free-ranging power type : 14.2 mA			
Measuring cycle	Typical	T	8 ms/cycle					
Output characteristics	Remain voltage	Maximum	V <sub>r</sub>	1 V.DC	1.2 V.DC	1 V.DC	I <sub>t</sub> =100 mA	
	Leakage current	Maximum	II	5 μA		3 μA	V=30 V.DC	

Notes : \* The thin short type is only available for 5 V.DC.

2) External triggering type (trigger conditions: trigger pulse width = 20 μs and trigger synchronization = 5 ms)

Items			Symbol	Thin short type*1		Short type	Middle type	Long type	Measured conditions		
				NPN output type	PNP output type						
Rated operating voltage	Minimum	VDD	5 V.DC type : 4.5 V.DC / Free-ranging type : 5.5 V.DC								
	Typical		-								
	Maximum		5 V.DC type : 5.5 V.DC / Free-ranging type : 27 V.DC								
Average current consumption	Without trigger input	Output OFF	Minimum	-					*2 ♣b		
			Typical	Ib		0.1 mA				5 V.DC type: 0.1 mA/Free-ranging type: 1.0 mA	
			Maximum	Ib		0.3 mA				5 V.DC type: 0.3 mA/Free-ranging type: 1.8 mA	
		Output ON	Minimum	-						*2 ♣d	
			Typical	Id	2.6 mA	6.7 mA	5 V.DC type: 0.5 mA/Free-ranging type: 1.4 mA				
			Maximum		6.6 mA	9.6 mA	5 V.DC type: 3.4 mA/Free-ranging type: 4.5 mA				
	With trigger input	Output OFF	Ia	Minimum		-			*2 ♣a		
				Typical		2.2 mA		5 V.DC type: 2.2 mA/Free-ranging type: 3.1 mA			
				Maximum		6.2 mA		5 V.DC type: 6.2 mA/Free-ranging type: 7.2 mA			
		Output ON	Ic	Minimum		-			*2 ♣c		
				Typical		4.2 mA	8.5 mA	5 V.DC type: 2.4 mA/Free-ranging type: 3.3 mA			
				Maximum		8.2 mA	12.5 mA	5 V.DC type: 8.2 mA/Free-ranging type: 9.3 mA			
Measuring cycle (Trigger interval)		Typical	Tt	5 ms/cycle							
External trigger	Pulse width	Minimum	20 μs						Half off the distance period		
		Maximum	1/2 Tt								
	Level	Minimum	V <sub>TL</sub>	0.8 V				*3			
		Maximum	V <sub>TH</sub>	3 V							
Response performance: time from trigger pulse fall to detection output		Typical	Tr	5 ms							
Output characteristics	Remain voltage	Minimum	Vr	1 V.DC	1.2 V.DC	1 V.DC		It=10 mA			
	Leakage current	Maximum	Ii	5 μA		3 μA		V=30 V.DC			

Notes : \*1. The thin short type is only available for 5 V.DC.

\*2. The ratio between the 4 operating modes (♣a to ♣d) depends on the external trigger period and detector time, and the current consumption corresponds with this varying ratio.

\*4. The output transistor is open collector.

The output transistor is turned ON by the sensor detection status and turned OFF by its non-detection status.

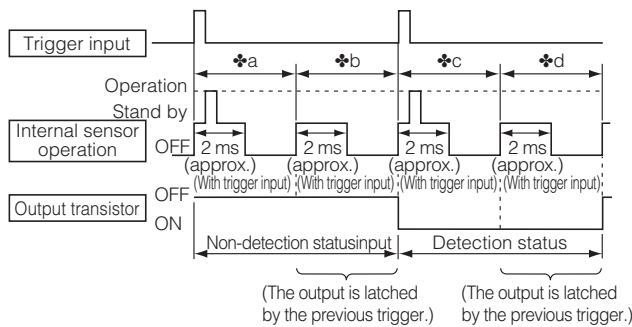

\*3. A high level is established in the open state due to pull-up by the internal circuit. (Refer to the connector wiring diagram.)

Detection status: output transistor ON  
Non-detection status: output transistor OFF

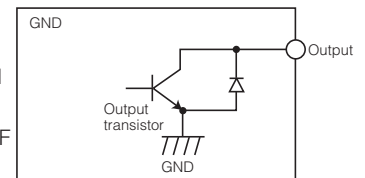

(NPN output types of the AMA series and all of AMBA series)

Detection status: output transistor ON  
Non-detection status: output transistor OFF

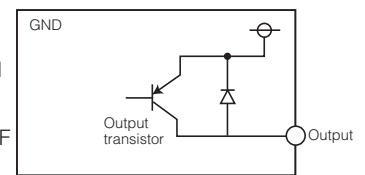

(PNP output types of the AMA series)

## Timing Chart

### ● Built-in oscillation circuit type

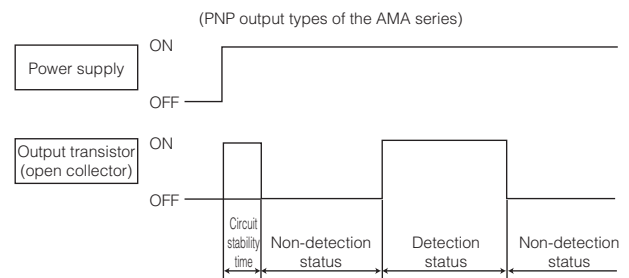
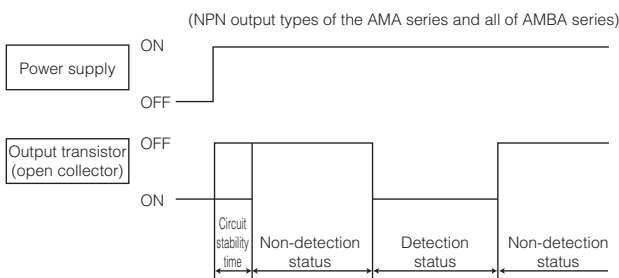

Notes : \*1. Circuit stability time : Max. 12 ms

\*2. During the time taken for the circuit to stabilize after the power is turned on, the ON/OFF status of the output transistor is not determined by whether the sensor is in the detection status or non-detection status.



## External triggering type

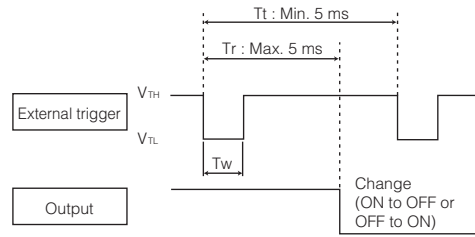
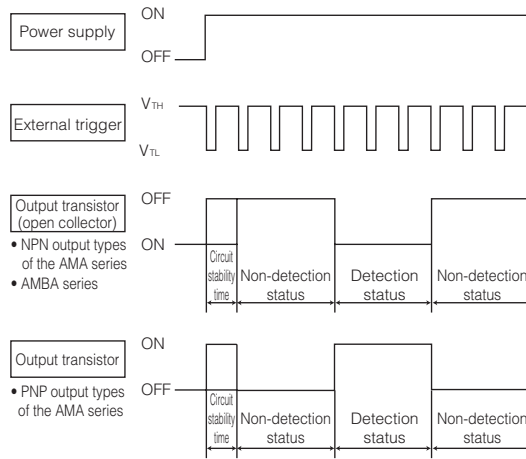

Notes : The sensor recognizes at the  $V_{TH} \rightarrow V_{TL}$  edge of an external trigger that the external trigger has been input.

- Notes : \*1. Circuit stability time: Max. 12 ms  
 \*2. During the time taken for the circuit to stabilize after the power is turned on, the ON/OFF status of the output transistor is not determined by whether the sensor is in the detection status or non-detection status.

## How To Use

### Wiring diagram of connector

	Built-in oscillation circuit type	External triggering type
NPN output type		
PNP output type		

- Notes : \*1. The output transistor has an open collector structure.  
 • Detection status: Output transistor ON (connected to GND)  
 • Non-detection status: Output transistor OFF (open state)  
 \*2. The status of the external trigger input is as follows:  
 • Open at the high level  
 • GND (less than 0.8 V) at the low level  
 Do not apply a high voltage.  
 \*3. Install capacitor (of 33 µF or over) on the power input terminal of the sensor in order to secure power superimposed noise resistance and stabilize the power supply voltage.

## Reference Data

### Operating region characteristics

How to interpret the graph

Example: Operating area of the Short Type with rated detection distance of 8 cm 3.150 inch.

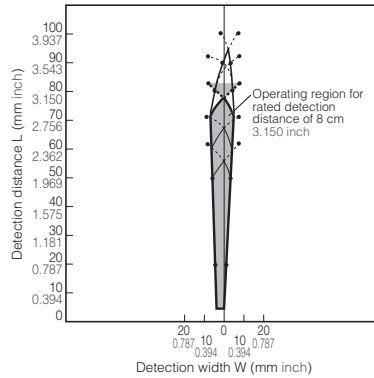

Operating area within the dotted lines

Objects that enter the entire area are detected.

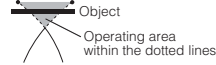

Note: If only part of the object is in the detection area, it is not detected.

Operating area within the solid lines

Objects that even partially enter the area are detected.

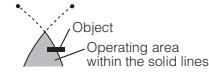

1.-(1) Thin short type (AMA1□□□□□) Short type (AMBA1□□□□□)

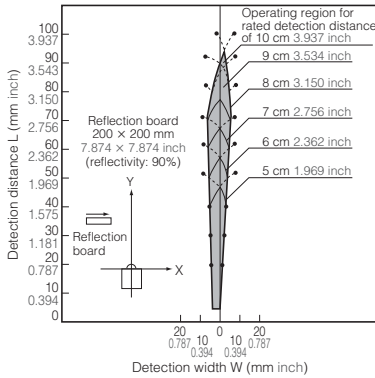

1.-(2) Middle type (AMBA2□□□□□)

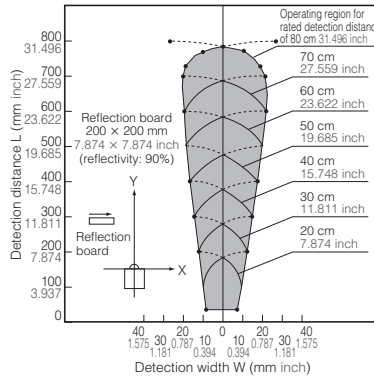

1.-(3) Long type (AMBA3□□□□□)

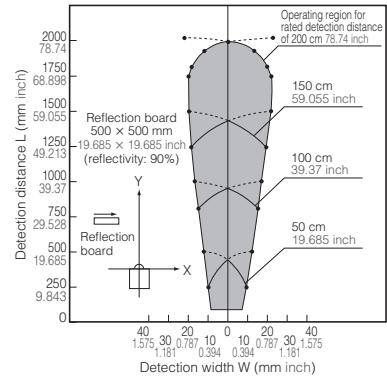

## Dimensions

The CAD data of the products with a **CAD Data** mark can be downloaded from: <http://industrial.panasonic.com/>

(Common to the Built-in oscillation circuit type and External triggering type)

### Thin short type (V type)

**CAD Data**

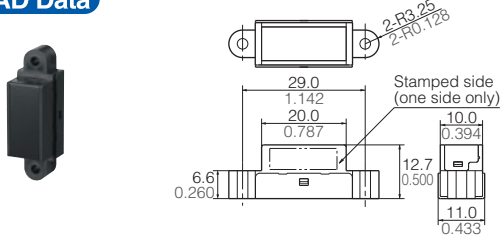

\* Rear side connector protrusion: Max. 0.4mm

### Short type (H type)

**CAD Data**

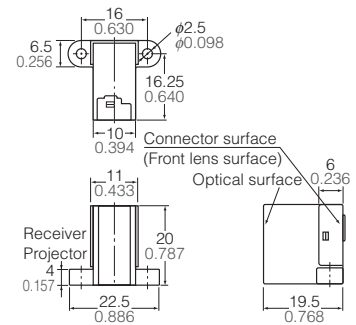

### Middle type (H type)

**CAD Data**

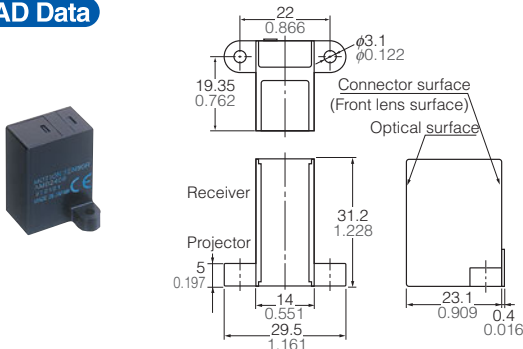

unit : mm inch



(Common to the Built-in oscillation circuit type and External triggering type)

● Long type (H type)

**CAD Data**

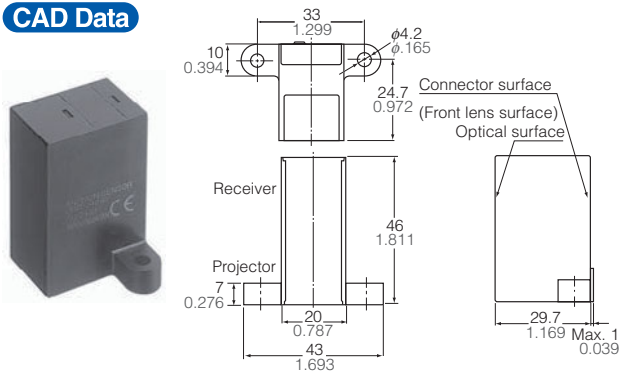

● Long type (V type)

**CAD Data**

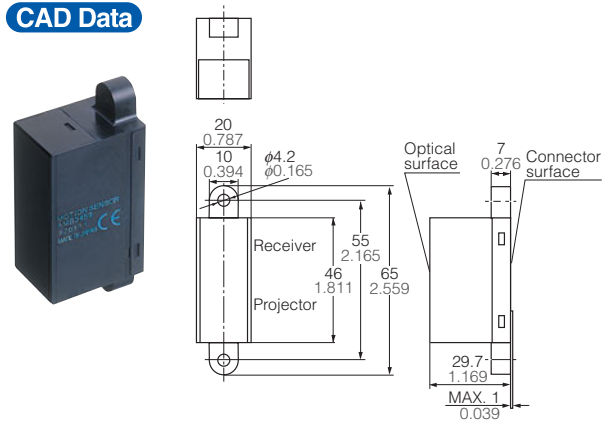

unit : mm inch

## Wiring Diagram (Connector Surface View)

● Thin short type (V type)

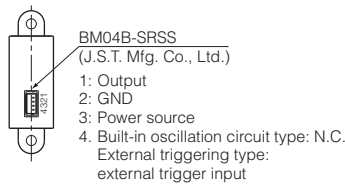

● Short type (H type)

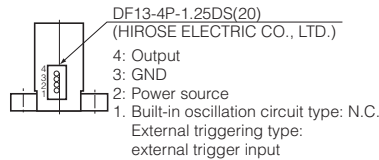

● Middle type (H type)

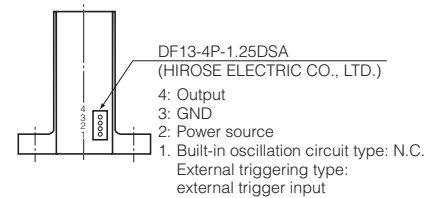

● Long type (H type)

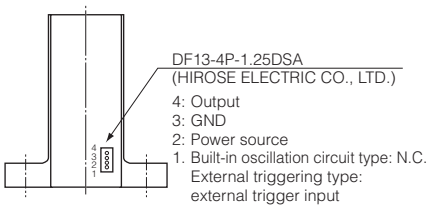

● Long type (V type)

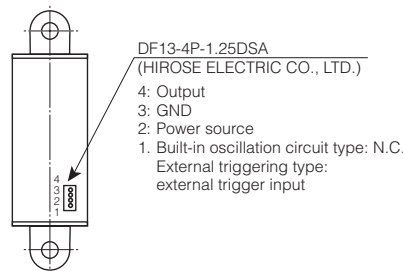

## Options

● Connector with cable (for Short, Middle and Long type)  
AMV9003

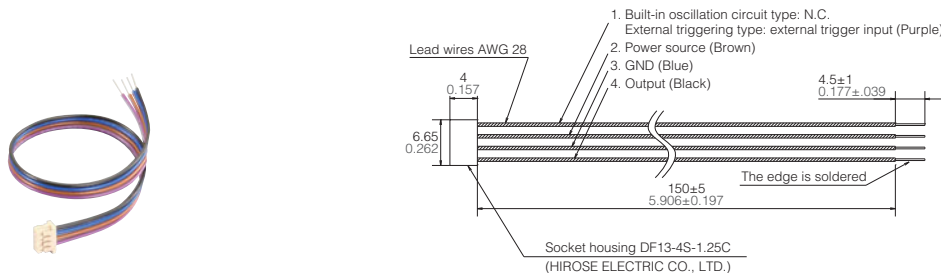

unit : mm inch

● Connector with cable (for Thin short type)  
AMV9002

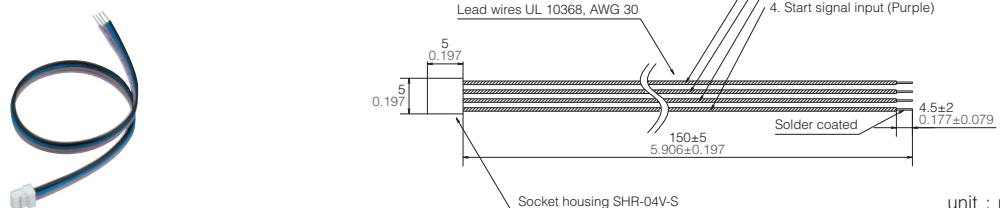

unit : mm inch

## NOTES

### ■ Use environment

- 1) Avoid use in the steamy or dusty environment, the corrosive gas, an environment where organic solvent can be adhered.
- 2) When using in a high-noise environment, perform countermeasures such as installing capacitor (of 33  $\mu$ F or over) on the power input terminal of the sensor. Before use, check the performance under actual use conditions.

### ■ Wire connection

- 1) Before the power is supplied, recheck wiring as misconnection may damage the internal circuit. (ensure to avoid reverse connection)
- 2) Use wires shorter than 3 m 9.842 ft to protect the internal circuit. Before use, check under actual use conditions if there is no influence by surrounding environments.
- 3) Do not repeatedly attach/detach the connector.

### ■ Detecting part

- 1) Keep the detecting surface clean. The detecting surface is resistant to trash/ dust, however, if an excessive amount of trash/dust adhere to the surface, it may reduce the margin of detecting distance.
- 2) Dew condensation on the detecting surface may cause malfunction.
- 3) The sensor aims to detect human bodies. If the targeted object has extremely low reflectivity (e.g., objects frosted by black rubbers) or extremely high reflectivity (e.g., objects which regularly reflect: mirrors, glasses or glossy papers), the sensor may not be able to detect or the detecting distance may become unstable.
- 4) The front face of the lense and the case are polycarbonate-based. Generally they are stable against water, alcohol, oil, salt and weak acids. However, avoid alkalis, aromatic hydrocarbons and halogenated hydrocarbons as those substances may expand or melt the lense and the case.
- 5) If placing filters (covers) in front of the sensor and perform detection through the filters, following may occur: detection of the filters (covers), changes of the detecting distance or unstable operations.
- 6) If sensors are in facing positions, light from the opposing sensor may cause mutual interferences and malfunction. Before use, check the installation conditions.
- 7) When arranging multiple sensors in parallel, keep the interval of neighboring sensors as below or over. Before use, ensure that there is no mutual interference.

Part No.	Sensor interval
AMBA1 series	5 cm 1.969 inch
AMA1 series	8 cm 3.150 inch
AMBA2 series	10 cm 3.937 inch
AMBA3 series	20 cm 7.874 inch

### ■ Recommended mounting direction

As below, install the sensor for the X and Z advancing directions of the targeted object.

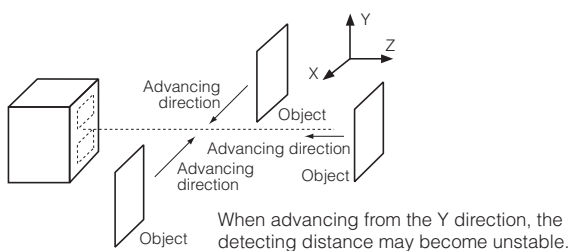

For general precautions, see "General precautions for motion sensors" in the next page.

### ■ Ambient operating conditions

- 1) Temperature: Refer to the absolute maximum ratings for the temperature of each individual sensor.
- 2) Humidity : 15 % to 85 % RH (No freezing nor condensation at low temperature)
- 3) Atmospheric pressure: 86 to 106 kPa
- 4) Because the humidity range differs depending on the ambient temperature, the humidity range indicated below should be used. Continuous operation of the switch is possible within this range, but continuous use near the limit of the range should be avoided. This humidity range does not guarantee permanent performance.

<MA Motion Sensor>

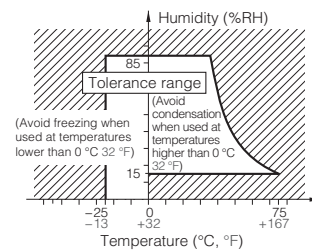

In general, degradation of electronic devices accelerates when they are operated under conditions of high temperature or high humidity. Before use, confirm the reliability of the sensors under the expected operating conditions.

- 5) The sensors do not have a water-proof or dust-proof construction. Depending on the ambient operating conditions, some means of providing protection from water and dust and preventing the formation of ice and condensation must be provided prior to using the sensors. If a sensor is used with a cover installed, the initial detection performance specifications may not be able to be met. Confirm the operation under the actual operating conditions.
- 6) Take care to avoid exposing the sensors to heat, vibration or impact since malfunctioning may result.

### ■ Concerning external surge voltages

Since the internal circuitry may be destroyed if an external surge voltages is supplied, provide an element which will absorb the surges.

### ■ Concerning power supplysuperimposed noise

- 1) Use a regulated power supply as the power supply. Otherwise, power supplysuperimposed noise may cause the sensors to malfunction.
- 2) To maintain the power supply noise performance, be certain to connect a capacitor (33  $\mu$ F or more) to the sensor power supply input terminal in order to stabilize the power supply voltage.

### ■ Drop damage

If the sensor is dropped, damage can occur resulting in incorrect operation. If dropped, be sure to do a visual check of the exterior for noticeable damage and check the operation characteristics for faulty operation.

### ■ Concerning the circuit sides

Since the circuit sides given in this catalog are not protected in terms of circuit design, check out the performance and reliability of the circuits prior to using the sensors.

## X-ON Electronics

Largest Supplier of Electrical and Electronic Components

*Click to view similar products for [Sensor Hardware & Accessories](#) category:*

*Click to view products by [Panasonic](#) manufacturer:*

Other Similar products are found below :

[62105012-000](#) [F03-01 SUS304 BINIL](#) [FH-AP1](#) [PH-1-10M](#) [PH-1-20M](#) [PH-2-30M](#) [AC201](#) [R4](#) [R-8580-360](#) [ADI-LC3S](#) [E39-L149](#) [PBT420-100R](#) [K35-4](#) [SDV-DH3 DC48](#) [SDV-DH7 AC200/220](#) [SDV-FL3 DC48](#) [SDV-FM2 DC24](#) [SDV-FM3 DC48](#) [SDV-FM6 AC100/110](#) [SDV-SH15](#) [A-1923](#) [ES2-THB](#) [STA12](#) [AP4-T](#) [PH-1-50M](#) [R-8580-362](#) [D01051301](#) [3Z4S-ML-PL305](#) [43912557-020](#) [MF-1 D=3.2](#) [BGN-035](#) [05282945-006](#) [E39-L7](#) [EE-1006-8 2M](#) [SDV-FL6 AC100/110](#) [SDV-FL7 AC200/220](#) [SDV-FM7 AC200/220](#) [SDV-SH10](#) [8000-5110](#) [ZX-SB11](#) [ZLR12GI12V3](#) [XZCC43FCP40B](#) [D01070602](#) [606075](#) [ZCM077GIV5](#) [Y92ES12PVC4A10ML](#) [Y92ES12PVC4S5ML](#) [ZFV-XMF2](#) [28810-2](#) [ZX-SW11E V3](#)