

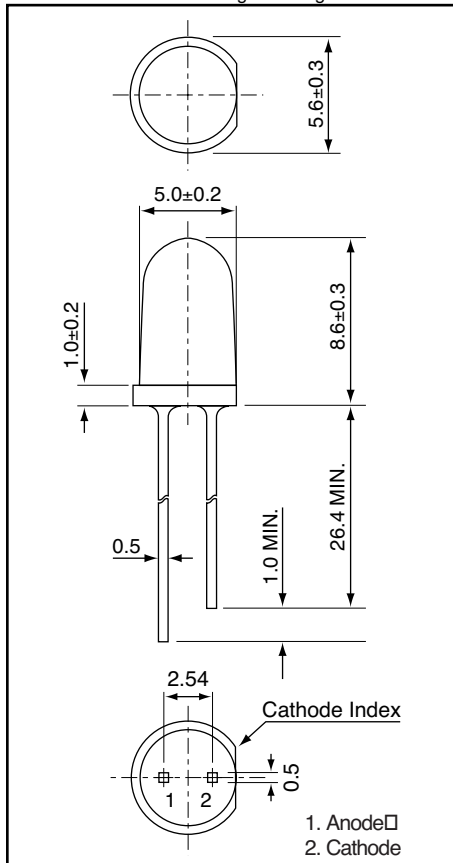

Weight: 0.31 g Unit: mm



# AND180HSP

## InGaAlP High Brightness Red Light Emission T-1 3/4 Package (5 mm)

### Features

- Peak wavelength ( $\lambda_p = 623$  nm) high bright emission
- All plastic mold type, clear colorless lens
- Low drive current: 1 to 20 mA DC
- Excellent On-Off contrast ratio
- Fast response time, capable of pulse operation
- High power luminous intensity
- Suitable for Outdoor Message Signboards, Automotive Use
- **RoHS Compliant**

### Maximum Ratings ( $T_a = 25^\circ\text{C}$ )

Characteristics	Symbol	Rating	Unit
Forward Current	$I_F$	50	mA
Reverse Voltage	$V_R$	5	V
Power Dissipation	$P_D$	125	mW
Operating Temperature Range	$T_{Opr}$	-40 to 85	$^\circ\text{C}$
Storage Temperature Range	$T_{Stg}$	-40 to 100	$^\circ\text{C}$

### Electro-Optical Characteristics ( $T_a = 25^\circ\text{C}$ )

Characteristics	Symbol	Test Condition	Minimum	Typical	Maximum	Unit
Forward Voltage	$V_F$	$I_F = 20$ mA	–	2.1	2.8	V
Reverse Current	$I_R$	$V_R = 4$ V	–	–	10	$\mu\text{A}$
Luminous Intensity	$I_V$	$I_F = 20$ mA	3,200	6,000	–	mcd
Peak Emission Wavelength	$\lambda_p$	$I_F = 20$ mA	–	623	–	nm
Spectral Line Half Width	$\Delta\lambda$	$I_F = 20$ mA	–	18	–	nm
Dominant Wavelength	$\lambda_d$	$I_F = 20$ mA	–	613	–	nm
Full Viewing Angle	$q$	$I_V = 1/2$ Peak	–	6	–	degree

### Precaution

Please be careful of the following:

1. Soldering temperature:  $260^\circ\text{C}$  max  
Soldering time: 5 sec. max  
Soldering portion of lead: up to 1.6 mm from the body of the device
2. The lead can be formed up to 5 mm from the body of the device without forming stress.  
Soldering should be performed after the lead forming.

Product specifications contained herein may be changed without prior notice.

It is therefore advisable to contact Purdy Electronics before proceeding with the design of equipment incorporating this product.

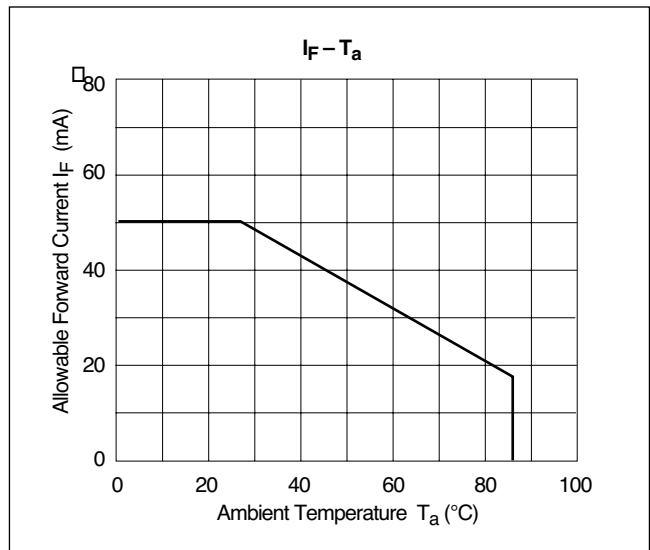
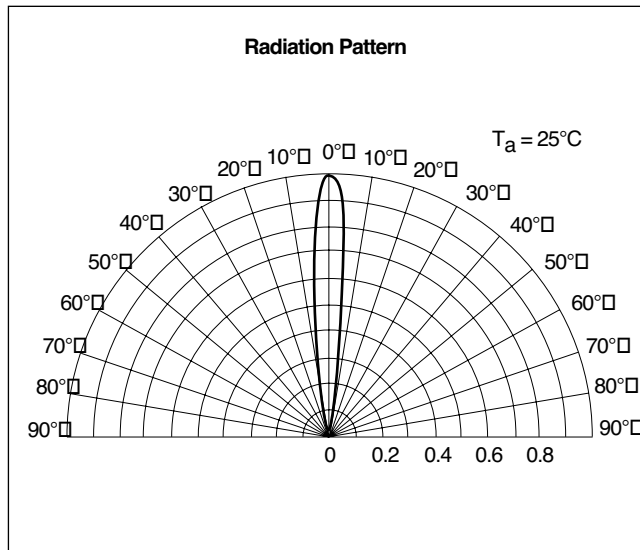
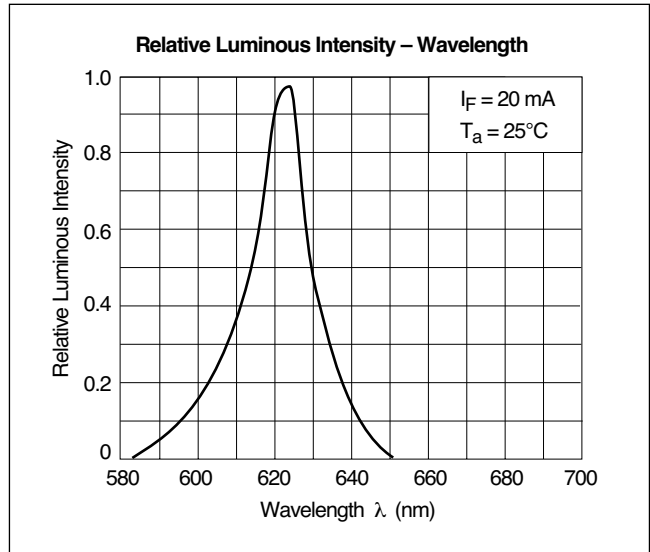
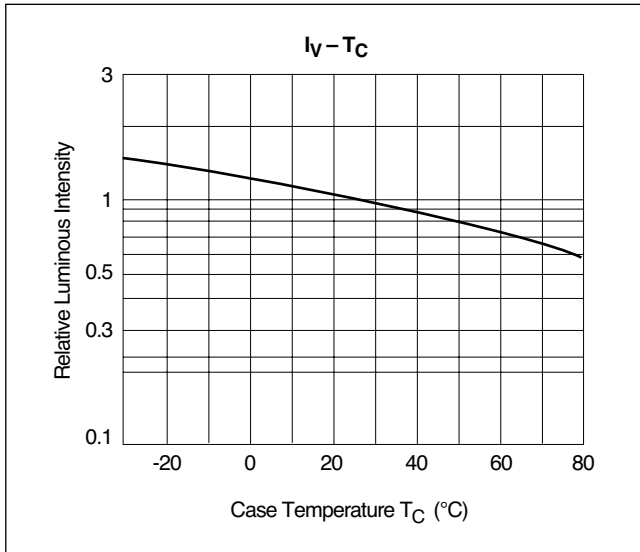
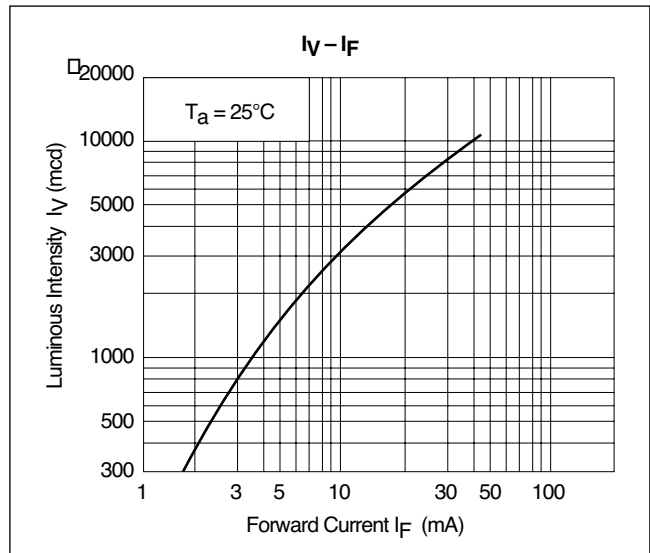
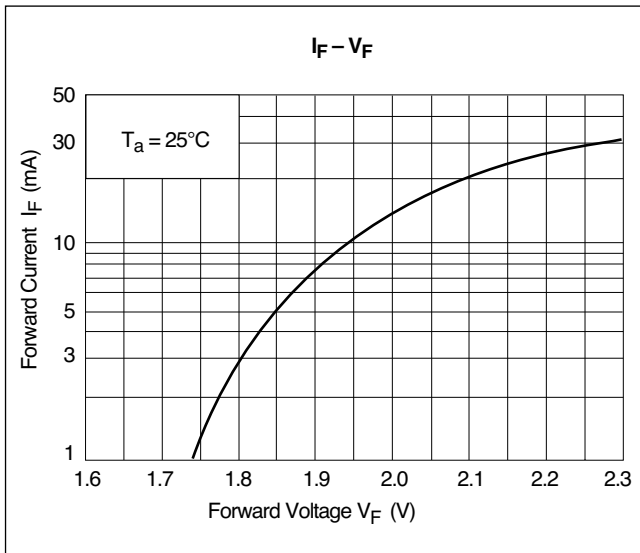

## **X-ON Electronics**

Largest Supplier of Electrical and Electronic Components

*Click to view similar products for [and manufacturer:](#)*

Other Similar products are found below :

[EVB5.1 V5 ATMEGA32](#) [AND241](#) [AND113Y](#) [AVRPROG-MKII-ECO](#) [AND130CR](#) [AND113R](#) [AND180AYP](#) [AND721GST-LED](#)  
[FE0203W-DU](#) [AND155CRP](#) [AND114YP](#) [FE0206W-DU](#) [AND262HBA](#) [AND113GP](#) [AND2451RGL](#) [AND114-R](#) [AND124R](#) [AND123R](#)  
[AND120CRP](#) [AND240GCP](#)